

FESTO

New products 2012

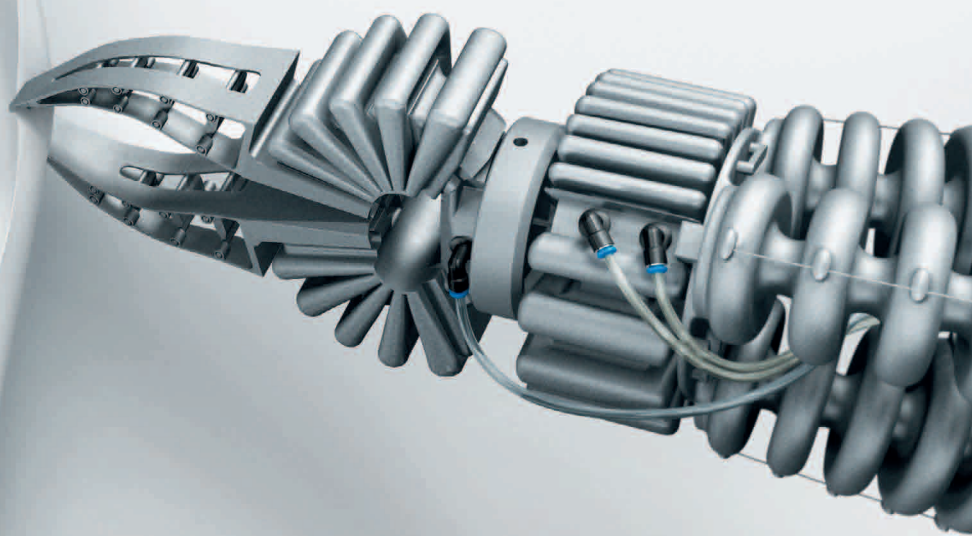



The duty of success – to offer you even more in the future.

By now, you have probably already seen the → **"bird flight"** of our SmartBird, either live at one of our customer events or in the online video clip. That was just one of the highlights that 2011 had in store for Festo. Another one was that we were able to increase the group's turnover to over 2.1 billion euros!

For that we would like to say a big thank you to you – our customers. This proves the effectiveness of partnership in automation.

However, this also represents a duty on our part to ensure that your automation is successful. Concrete factors such as a good, innovative → **product strategy**, intelligent and intuitive → **solutions** for factory automation and process automation and reliable deliveries are the core of this objective. But there are less tangible factors that are also becoming increasingly important, for example: excellent → **design**, combined with great customer benefits, outstanding → **engineering tools** and services throughout the entire value added chain.

Call on us to do our duty – we're certain you will benefit from it! **Simply Festo!**



Dr. Eberhard Veit,
Chairman of the Management Board and
Member of the Management Board, Technology and Market Positioning
of Festo AG

→ **More on the bird flight:**
www.youtube.com/festohq

→ **Product strategy**
Turn to p. 20 for
our new products

→ **Solutions:**
What benefits do our
solutions offer? p. 8

→ **Design:**
What makes a good
design? p. 16

→ **Engineering tools:**
How to accelerate
design and operation:
p. 14

New products 2012 – Contents

5 Editorial

6 Contents

Topics for 2012

- 8 A rewarding initiative: factory automation meets process automation at B. Braun in Melsungen
- 10 Ultra-fast equipment for ultrasonic welding
- 14 New York, Rio, Tokyo - Festo engineering tools always help
- 16 Eye-catching, consistent, helpful: product design = customer benefits
- 18 Man and machine – hand in hand.
Considering the future of automation

Products for 2012

- 20 Pneumatic and electric drives
- 26 Valves and valve terminals
- 32 Compressed air preparation,
vacuum and connection technology
- 36 Electronic systems
- 40 Process automation

- 18 Will we be able to control machines by thought in the future?
Find out with Nadine Kärcher, one of the Festo employees who is shaping the future.





8 Why does the standardisation and simultaneous planning of factory and process automation pay off? Cristina Molina of B. Braun AG in Melsungen explains.



10 Why is Festo an excellent partner for innovation-driven companies such as Widmann Maschinen GmbH? Achim Bauder explains.



14 Marco Antonio Ramirez Parra demonstrates how customers can become faster and better with Festo engineering tools.



16 Karoline von Häfen explains what makes a good design and the benefits it can bring.



"We benefit from this in terms of design, delivery, maintenance, training – and with improved process reliability."

Cristina Molina, Project Manager at B. Braun

Standardised automation: infusions that pay off

B. Braun Melsungen AG's plant in PfiEFFewiesen, Germany is an industrial masterpiece. At its heart is the "leading infusion factory in Europe," the most modern production facility for infusion solutions, which has been automated using sophisticated valve technology in ready-to-install control cabinets.

Standardised automation – that was the guiding principle behind the production of infusion solutions in new three-chamber bags. A huge range of machines and systems required standardisation – from batch systems, filling equipment, sterilisers and inspection machines right through to packaging. For the first time, the aim was to achieve this in the new → **life nutrition system** through the primary and secondary zones of pharmaceutical production – i.e. throughout the entire value added chain.

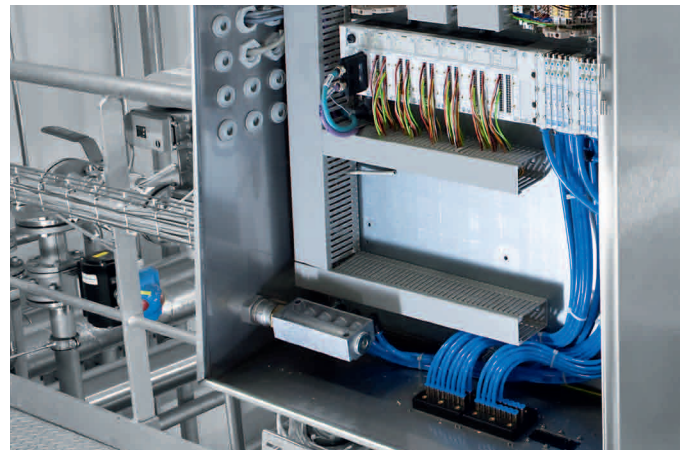
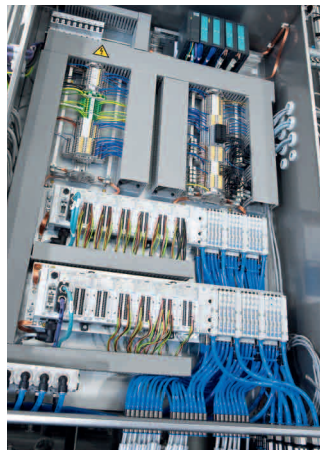

One control cabinet – different equipment. The fact that all the components have a set place makes the supervisors' day-to-day work easier, as they can find their way around each control cabinet straight away.

"Our systems," explains Cristina Molina, Project Manager at B. Braun, "are now easier to maintain. Fewer spare parts, → **shorter training times** for maintenance personnel and one contact person for pneumatics have significantly reduced our costs throughout the entire product life cycle."

As a simple way of ensuring compliance with legal standards, the entire production process is checked and documented by a paperless, fully automatic process control system.

1 Part number,
Order,
Contact person

Ready-to-install solution from the automation partner to the biotech/ pharmaceutical industry

Standardisation from process to packaging

Following a joint analysis, the team recommended a standard for tailor-made valve terminal cabinets, drew up a recommendation for an operating system and coordinated everything with all the companies involved in order to ensure that deadlines and the standard of the project could be met.

The valve terminal CPX/MPA was established as the core of the automation at the sensor/ actuator level. Thanks to its versatile control concept, it was possible to connect all the feedback devices, drives and process valves to the bus-controlled valve terminal as an I/O assembly. This now controls 4,000 diaphragm valves and other process valves. From the process systems to the packaging machine, B. Braun can now rely on standardised product technology based on a binding product approval list.

From a single source

Festo designed, built and delivered 45 ready-to-install valve terminal cabinets directly to the systems. The tested, complete solutions lightened the load on the customer's staff, reduced design times, streamlined the procurement process and reduced process costs.

"Especially given the tight deadlines in the construction of the system, → **ready-to-install solutions** are ideal," explains Cristina Molina. "But with the control cabinets, we needed much more than just a sales agent – we got comprehensive advice, from a 3D model to the design coordination."

Life nutrition systems in biotech and pharmaceutical production:
→ www.festo.co.uk/biotech

Ready-to-install solutions:
→ www.festo.co.uk
(click on product CPX-L)

Shorter training times:
→ www.festo-didactic.com



"We want a partner whose technological expertise will enable us to realise the full potential of our innovations."

Achim Bauder, Head of Sales and Marketing at Widmann Maschinen GmbH

Innovation breeds innovation: ultra-fast with ultrasonics

Ultrasonic welding is fast and precise. As such, it is ideal for combining plastic components and sheets. In order to enable the systems at Widmann Maschinen GmbH to make full use of their high speeds, the built-in high-speed T-gantry carries out the pick & place duties.

The advantages of ultrasonic welding can be seen in the joining of plastic sheets and small or medium-sized thermoplastic components with plastic sheets. Due to the short cycle times (measured in tenths of a second) and the use of lower cost materials such as polypropylene, the process pays off when producing large batches for series and mass production. Important application sectors include the office products industry, the automotive supplier industry, the household goods industry and packaging technology.

Highly productive

Using the ultrasonic welding technology, packaging machines can seal, weld and separate in one step and using only one tool. The welding time itself is a matter of milliseconds. There are no warming up and cooling down times, as ultrasonic welding is a "cold" welding procedure. This reduces setting-up times to a minimum. The versatile process bonds different material pairs without adhesives or solvents, e.g. paper with various types of plastic sheeting.

"The quality of the welding seams in the welding process is also first-class," says Achim Bauder, Head of Sales and Marketing at Widmann Maschinen GmbH. "Neither "angel hairs", sharp edges nor particles are a problem. What is more, we can document all the process parameters." The company has already been using this technology successfully in its fully automated office products line for more than 15 years, producing articles such as folders, ring-binders and transparent sleeves.

Pick & place in <500 ms

When the packaging machine was developed, the engineers quickly realised that a Z-axis with a motor as a feed system was unable to match the speed of the welding process. "A cycle time of 1.13 seconds was far too slow," explains Bauder. "We needed a really fast feed system."

Festo came up trumps. A project team within the Solution Engineering Center Europe was already working on the development of the high-speed T-gantry. The project team then incorporated the specifications and wishes of Widmann. "The result was a pick & place system that pleasantly surprised us with its cycle time of < 500 ms," recalls Achim Bauder.

<500_{ms}

or 30% faster cycle times are required from the new high-speed T-gantry in order to get the innovations of Widmann working properly. Mission accomplished!



Cutting plastic sheets in pictures:
[→ www.festo.co.uk/cpx](http://www.festo.co.uk/cpx)

Everything you need to know about a vacuum:
[→ www.festo.co.uk](http://www.festo.co.uk)

- Products
- Vacuum technology

A clever design

The gantry achieves its speed of 4 m/s and acceleration of 50 m/s² across the entire working space thanks to a clever design: the two toothed belt axes are connected to the cross-member via a single recirculating toothed belt that passes around the drive shaft. The toothed belt is driven by two servo motors EMMS. As a positive side-effect, there is no need to move a motor in the X/Y plane, which has two degrees of freedom. The reduced mass and two servo drives positioned in parallel enable fast, dynamic movement – with less wear.

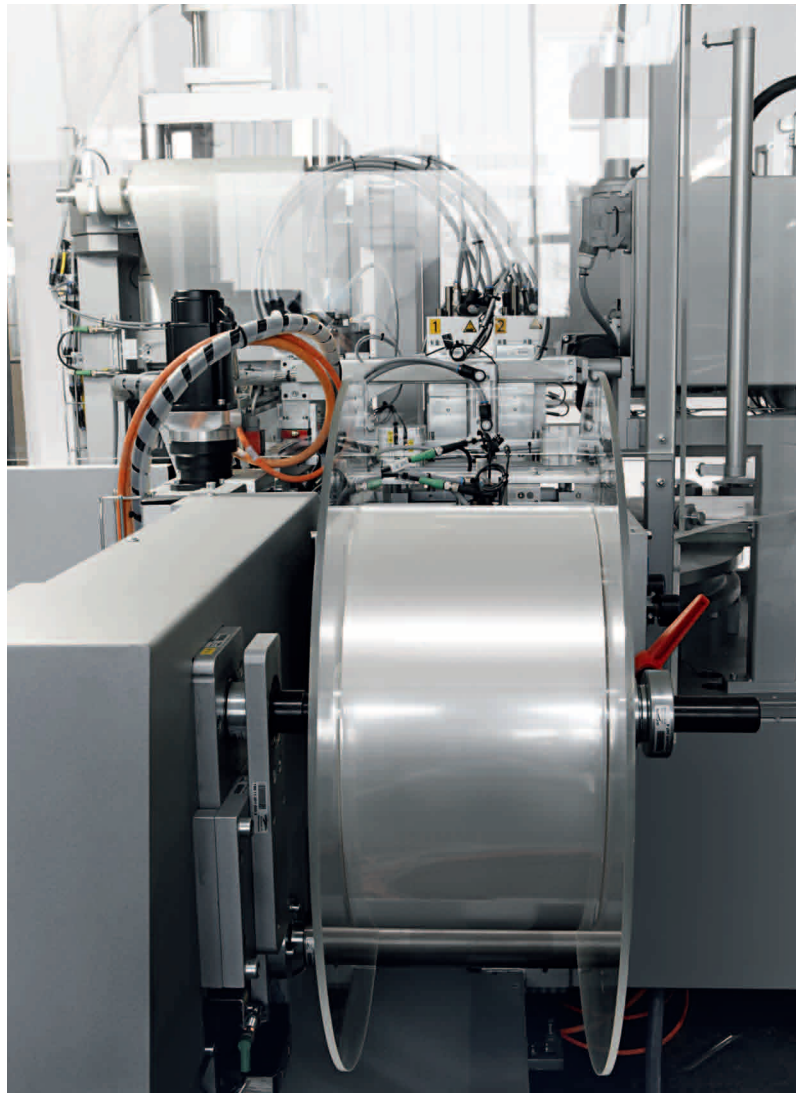

Specialist in ultrasonic welding: Widmann Maschinen also processes wafer-thin plastic sheets from thicknesses of 30 µm and upwards.

Fast cycle times, easy integration

"In compact ring systems, all the technical refinements of the machine enables up to 45 cycles per minute. With a linear welding station alignment, you can even reach up to 75 cycles," reports Bauder. The faster cycle times also mean short retooling times. "The fast program selection via the control panel automatically adjusts all the functions, regardless of whether the product is to be manufactured in batches of 1,000 or 100,000," he adds.

Festo delivered the high-performance system solution directly to the machines at Widmann Maschinen GmbH – pre-tested and complete with all the design data and circuit diagrams. The ultrasonic welding experts didn't just receive the hardware in the form of a ready-to-install sub-system – they got a complete value creation package.



A glimpse into the secret life of an ultrasonic welding machine.
Left: the high-speed T-gantry.

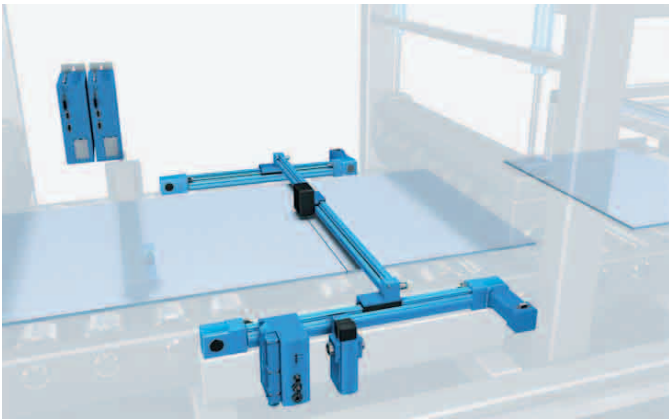

An absolutely straight cut: in this application, the sheet cutting process is completely synchronised with the speed of the sheet.

Thinking ahead: from sheet welding to → sheet cutting

Once they have been welded, the sheets often need to be cut*. For simple applications, the cutting on a running conveyor can often be performed using servopneumatic valves VPWP, while highly precise versions require synchronised electric axes. If necessary, a mix of technologies can be used. For high-quality results and a right-angle cut, the electric multi-axis controller CMXX on the modular electrical terminal CPX controls the axial movements of the electric linear axes EGC and DGCI.

The cutting frequency and the speed of the blade are adjusted exactly to the operating times of the conveyor upon which the sheets are being transported. This is calculated by the PLC in the control system. On request, the system can also include the pressure monitoring module CPX-4AE-P and the safety valve MS6-SV, which acts as a safety circuit.

* Please note:

The following applications are not part of Widmann Maschinen GmbH's system.

Reliable sheet gripping and leak testing with vacuum technology

The high speeds at which the sheets are moved into the ultrasonic welder and back out again are only possible when the sheets are reliably gripped at the front end using vacuum technology. This called for a combination of the vacuum generator VN and a suction cup ESG, e.g. with antistatic properties. This makes it easy to achieve much shorter cycle times thanks to the very fast evacuation times and accelerated gripping and placing of plastic sheets. The ejection pulse and the electric solenoid valve for the ON/OFF control of the vacuum are fully integrated.

The necessary leak test, e.g. at the joint between the bag and the end piece, is also carried out using vacuum sensors, which evaluate an analogue signal. Potential leaks are spotted due to the corresponding pressure drop. A valve terminal CPX/MPA with a pressure sensor module is used for the sensor activation and evaluation.



High-speed T-gantry: 30% faster than conventional handling systems.

30% faster: the high-speed T-gantry

The high-speed T-gantry is ushering in a new age of handling technology, offering the dynamic response of a linear motor handling system at the cost of a toothed belt handling solution. This makes them 30% faster than conventional handling units.

The T-gantry can be scaled to any stroke, is highly compact and boasts impressive acceleration in the Z-direction. It offers strokes in the Y-direction of 1,000 mm and strokes in the Z-direction of 300 mm, with a positioning accuracy of 0.1 mm.

You can download more information on **advanced handling systems** from Festo here:

→ www.festo.co.uk

- Support portal
- Keyword: advanced handling systems



"The engineering tools have helped us to significantly reduce our design times and thus the project costs – even internally."

Marco Antonio Ramirez Parra, Business Development PA Americas

New York, Rio, Tokyo – Festo engineering tools always help

Accelerated processes, tight deadlines, time-optimised production: the pressure of deadlines in machine building is constantly on the rise. Festo engineering tools enable this pressure to be managed better. From the first selection to After Sales Service, everything is available globally, 24/7.

Reliable product selection: searching in the electronic catalogue

Simply open the Festo electronic catalogue and enter the required technical parameters in the product configurator. Step-by-step, the system will determine the best drive for your project, for example.

The built-in tools and configurators enable you to find the right product quickly and easily using the product structure or other options. The intuitive product finder, engineering tools and configurators provide support for determining which technical attributes you want. You can also access all the more detailed product information, such as CAD files, accessories and documentation. You can then save the configuration in your favourites.

→ www.festo.com/catalog

Fast design with software tools

The CAD files for our products are available in a range of formats to help you create your own CAD drawings. If you need electric and pneumatic circuit diagrams, we can support you with our circuit diagram software FluidDraw P5, or circuit diagram macros for ePLAN. FluidDraw P5 offers a range of new functions, including drawing and sizing functions as well as circuit checks.

→ www.festo.co.uk/support

Secure, simple ordering: the online shop

The online shop ensures that design engineers and purchasers are always up to date. Here, you can check the availability of the components you want and find out immediately whether everything is in stock at the agreed price and can be delivered within two days, for example. Just-in-time, in the Kanban system or however you prefer. You can then send off your order or save your parts list for use at a later date. Once you have placed your order, the order tracking system allows you to see where your order is at any time.

→ www.festo.com/onlineshop

After Sales: support portal

Whether at the production site or in the office, the Festo support portal gives you all the information on our products – even those that are no longer available. In such cases, an alternative product will be suggested.

Using the Festo product key, you can call up product data such as the order code and transfer it to the electronic catalogue for potential re-ordering with just one click.

→ www.festo.co.uk/supportportal

"Accelerated, time-optimised processes are constantly increasing the pressure to meet deadlines in machine building. Engineering tools used throughout the entire value added chain help to manage this trend."

Prof. Dr. Dieter Spath,
Head of the Fraunhofer IAO, Stuttgart

24 / 7

Available any time, anywhere:
engineering tools from Festo

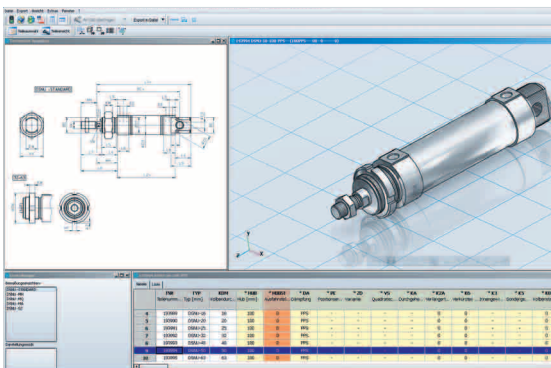

Design data: software for creating circuit diagrams, CAD data and ePlan macros.



"Design is more than a good shape.
It supports the functionality, guides the
user and thus ensures ease of operation."

Karoline von Häfen, Head of Product Design Processing

Eye-catching, consistent, helpful: product design is a customer benefit

"Good design is a direct benefit for our customers," says Karoline von Häfen, Head of Product Design at Festo. The focus lies on design quality and a clear product language, convenient operation and a well-structured product range.

When asked to describe this approach, she uses attributes such as technical, rational and practical, but also eye-catching and consistent. The latter two are important in ensuring that Festo products are highly recognisable, and remain so for years to come.

Whenever a new product is created, the Product Design department is involved right from the outset. A clear design that reflects the quality of the product, ease of use and ergonomics are the central criteria that Karoline von Häfen's team aim for. The design is then drawn up based on the technical concept.

Visitors wanted:

transparent production

Warwick, a manufacturer of electric bass guitars that numbers some of the world's top rock and pop stars amongst its customers, uses this automated production system – while systems manufacturer Minikomp Bogner GmbH places its trust in Festo axes and drives. And it's no surprise, when you consider the importance of how the components look: Warwick uses spotlight displays to show off the new system and attract new customers.

Also of no small importance in this transparent production process is the trust placed in the automated production method: The visitors, often musicians themselves, understand that automated processes are more precise than hand building – and that the ability to replicate quality is not dependent on how the craftsman is feeling on any given day.



Outstanding: the service units MS 9 won the German Design Award for their product benefits



10 Awards per year

received on average by Festo products since 2000, including the iF product design award and the reddot design award.

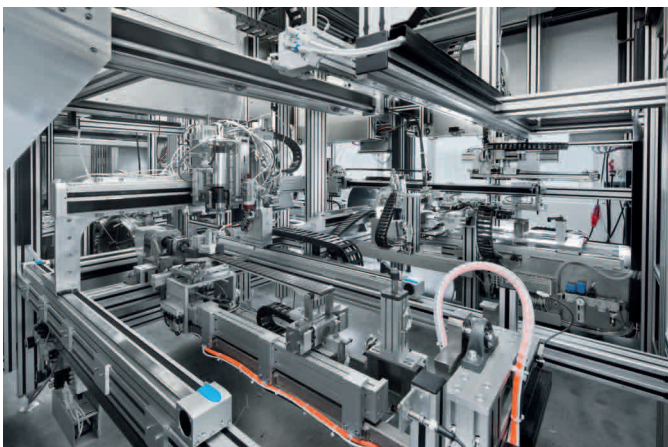

Clear structure, impressive presentation: production of bass guitar necks using components designed by Festo. In the bottom left corner, a giveaway: the easily removable blue cap is one of the electric axis EGC's distinguishing features; the radius of the end cap indicates the direction of rotation of the motor shaft.



"Developing a software solution that allowed us to process signals from a brain-computer interface and use them to control our own hardware was a thrilling task."

Nadine Kärcher, Project Manager for CogniGame

Man and machine – hand in hand

There are a great number of challenges currently facing the field of man-machine cooperation. How can the two work together? What is the best way to link human perception and reasoning with the attributes and power density of machines?

What conclusions can we draw from this for the field of automation? What information can we acquire on mechatronics and control technology? Festo used three projects from the Bionic Learning Network to investigate this topic from different perspectives.

Controlled by thought: CogniGame

The CogniGame is controlled by thoughts and gestures. The thoughts are transmitted by a brain-computer interface, which is first "trained" to recognise which areas of the brain are active when I think the command "move left" or "move right"? These patterns are then saved, and the axes of the hardware move in the corresponding direction the next time the same patterns occur.

The software, which was developed by Festo, serves as a bridge between the brain-computer interface and the hardware that allows control by thought.

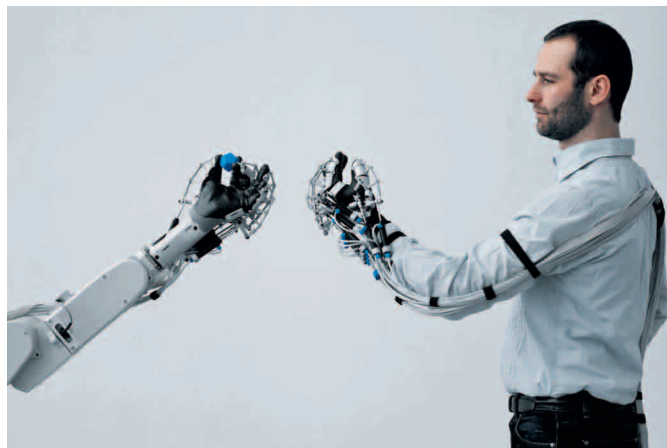

Cooperation between man and machine: the machine passes the man a ball via the ExoHand.

A new force: the ExoHand

Building up force during hard and strenuous tasks, recognising and teaching movement patterns in monotonous activities, therapy for people who have lost the function of their hands and arms following a heart attack, → **force feedback** for sensitive and precise use of force: the range of potential applications for the ExoHand is almost limitless. The Exoskeleton combines robotics and orthotics in an intuitive, "cooperative" man/machine system that uses Festo software to meld human intelligence with the mechanical force and abilities of a robot.

Artificial man-machine interaction: SoundMachines 2.0

→ **Roland Olbeter's** music system stands for intelligent music-making par excellence. Thanks to the use of creative composition techniques, no two pieces of music produced by the self-playing, mechatronic instrument are the same. The Sound Machines 2.0 react adaptively and flexibly to their environment. Equipped with electric drives and built-in → **CPX** functions, this quintet of musical machines shows how future system optimisation in factory and process automation and pioneering concepts for playful, factory-based cooperation between humans and technology might look.

→ **Like an EEG**, the brain-computer interface acts as an interface between the brain and the computer, and measures brain activity. These signals are then processed, evaluated and transmitted to the hardware in the form of control signals.

→ **Force feedback** transmits forces to the user via the computer. It is often used in computer games hardware.

More about CogniGame and ExoHand:
→ www.festo.com/bionic

More about controller CPX:
→ www.festo.co.uk/cpx

Pneumatic or electric drives? You choose!

Patented PPS principle

PPS cushioning allows the pistons to reach the end position dynamically but gently, allowing the air to escape.

- **Shorter installation times, faster assembly**
No need to adjust the cushioning
- **Higher energy conversion rate** and lower vibrations
- **Sizing software** for correct dimensioning and improved energy efficiency

Ideal for the food industry

No more risky adjusting screws



Optimally adjusted at all times, even during changes in load and speed

Outstanding: running characteristics for high speeds

Everything you need to know about PPS and pneumatic drives

And about what makes them so great, e.g. clean design for the food industry, one-way flow control valves, proximity sensors, tubing connections.

For more detailed information, visit our products page:

→ www.festo.co.uk

01 ADN-PPS

Your choice: simply the best. Both these technologies offers specific benefits. The decisive factor is the capacity of your system. For example, a pneumatic solution with the unique PPS cushioning – a world first. Or an electric solution with high speed and top precision.

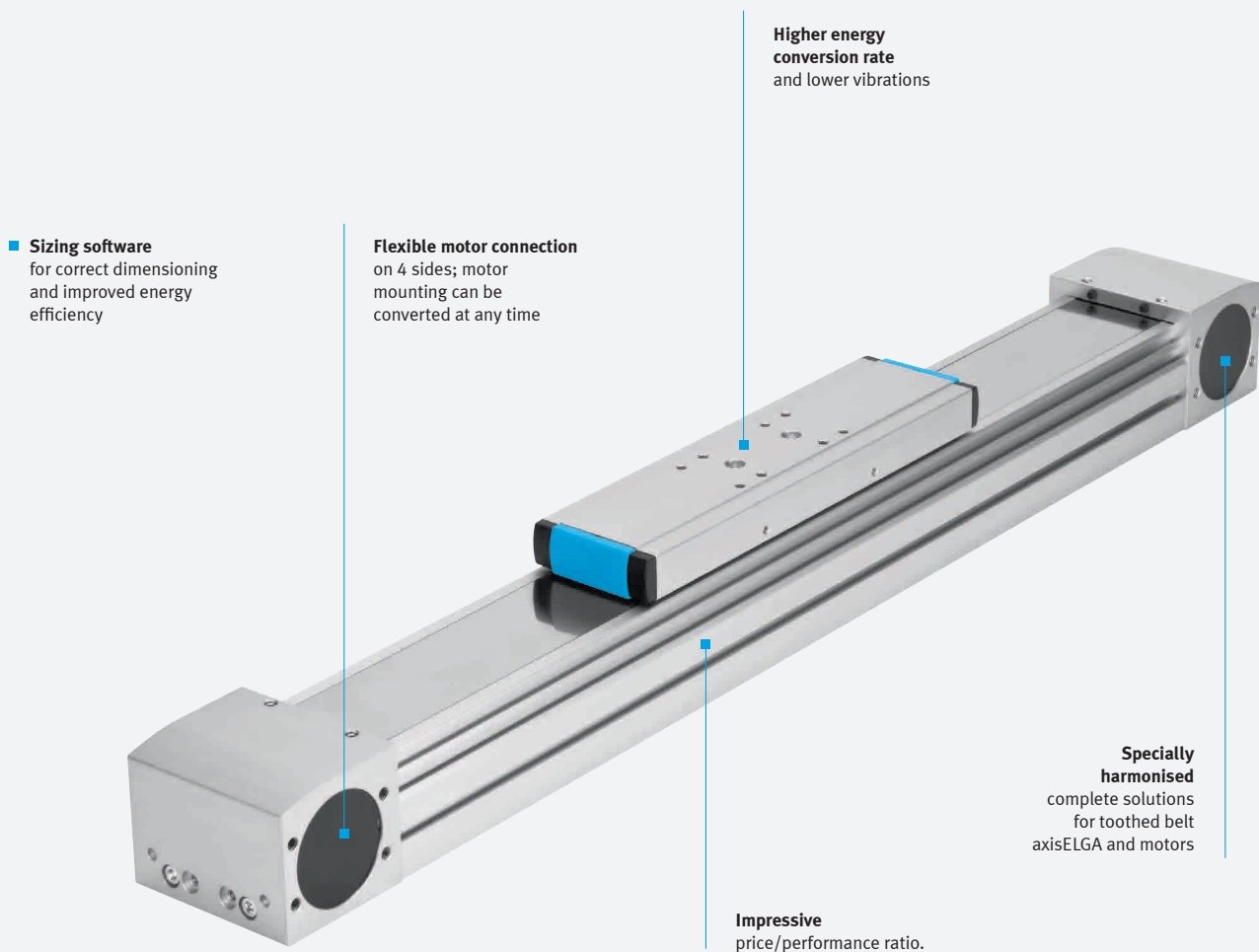

Fast travel, precise end point positioning

Using these two features only when really needed makes a handling system much faster. And more cost-effective as a fast toothed belt axis instead of a precise spindle axis will suffice. This is what our ideal combination might look like: an electric toothed belt axis ELGA ensures high-speed travel, while an intelligent vision system SBox-Q is responsible for the precision. It determines the actual point and ensures the transported goods are precisely positioned.

Get started simply and quickly with the commissioning service for axis systems.

Sizing software PositioningDrives.

For more detailed information, visit our products page:

→ www.festo.co.uk

02 ELGA-TB-G

Standard cylinder ADN-PPS to ISO 21287 with PPS cushioning

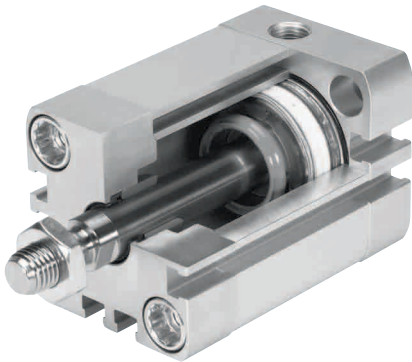

Adjusting the cushioning? Fine tuning? You can leave all that to PPS.

ADN-PPS: maximum productivity in tight spaces. The world's first pneumatic end-position cushioning system PPS automatically adjusts itself to changes in load and speed. This saves time and increases your process reliability, not least due to the reduced vibrations.

- High cycle times possible
- Ideal for OEMs: no unintentional re-adjustments
- Up to 50% shorter than the standard cylinder ISO 15552 – with the same stroke!

Gain 5 minutes for each cylinder mounted – it pays off. **01**

Pitch slide module DHMP/DHMB



No need to configure it yourself – just click and go!

The DHMP/B is the first of its kind in the world. It is perfect for fast picking, spreading and separation of small parts. Light and compact, it can be used instead of large and complex solutions, especially in tight spaces where short strokes are required. Includes simple construction and commissioning!

- Min. 10 million cycles without guide backlash
- Linearity and parallelism approx. 1/100 mm
- DHMB: basic slide version, DHMP: with additional Z-stroke
- Highly versatile; wide range of configurations

Electric toothed belt axis ELGA-TB-G with plain-bearing guide

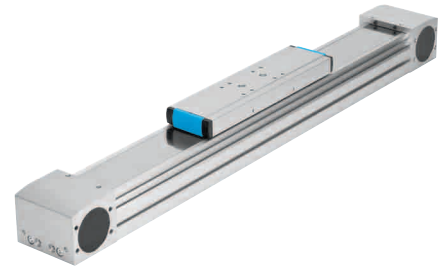

Choose the benefits you want to use.

High feed force for large, externally guided loads, or a low-cost option for simple tasks with light loads: ELGA-TB-G. A simple principle, more compact with swivelling and gripping in one. Highly versatile: position the motor on the left or right on both axis ends for all servo and stepper motors – and change it again at any time!

- Speed up to 5 m/s, acceleration up to 50 m/s²
- High feed force of up to 1,300 N
- Ready-to-install axis

Reliable and easy configuration of the ELGA-TB-G with PositioningDrives. **02**

Swivel/gripper unit HGDS

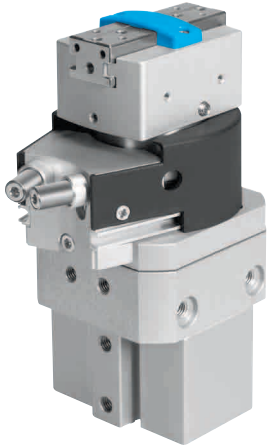

Picking and placing is now more compact with swivelling and gripping in one.

Highly efficient and powerful: the swivel/gripper unit HGDS. Swivelling and gripping can be controlled separately and individually. The HGDS is much more compact than the individual components, making it ideal for small, simple pick & place units.

- Torques up to 2.5 Nm, max. swivel frequency 2 Hz
- Freely adjustable swivel angle up to 210°
- Total gripping force up to 200 N at max. 14 mm total stroke
- Minimum opening and closing times of 40 ms

More handling systems. [03](#)

Swivel module DSM-...-HD with heavy-duty bearing

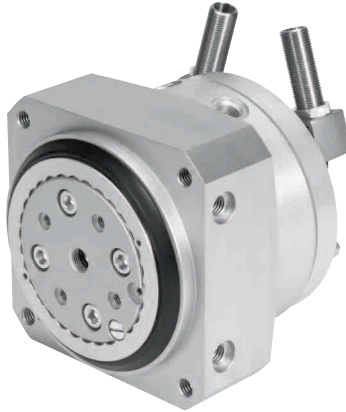

Top fit: the DSM-...-HD puts heavy loads away with no effort at all.

Up to 8 times the performance of its standard cousins for infinite swivelling up to 270°. And it still completely maintains its high running precision of <math><0.1^\circ</math> for up to 10 million cycles, thanks to its shock absorbers and adjustable fixed stop.

- Max. radial force: 1,800 N
- Preloaded, precise bearing with no backlash
- Max. torque at 6 bar: 40 Nm

Swivel module DSM-T-B with tandem vanes

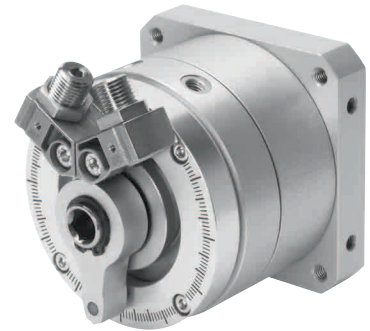

The DSM-T speeds up your rotation tasks – even with high loads.

The tandem vane doubles the torque, while the adjustable cushioning with fixed stop ensures maximum energy absorption and precision. The DSM-T-B is a powerhouse that doesn't lose any of its power and precision, even after 10 million cycles.

- Torque at 6 bar up to 80 Nm
- Versatile, stepless swivel angle up to 270° with a repetition accuracy of 0.1°
- Simple precision adjustment of end positions via the cushioning components



For more detailed information, visit our products page:

→ www.festo.co.uk

- [01](#) ADN-PPS
- [02](#) ELGA
- [03](#) HGDS

Parallel gripper DHPS



Perfect for packing a lot into a small space.

Slim, precise and powerful: the design of the new standard parallel gripper allows it to be used as an external or internal gripper. It really stands out with its high load bearing, very precise T-slot guide and the high gripping force of the gripper jaws. No interfering contours – minimal space required.

- Single and double-acting
- Gripping force backup and support
- Gripper jaw centring option
- Max opening stroke 25 mm

Reliable and efficient gripper design with software tools from Festo. **04**

3-point gripper DHDS



Make the standard your benchmark: DHDS!

Its small size and minimal space requirements provide a stark contrast to its high gripping force. It includes the high load bearing T-slot guide for a precise gripping movement and the sturdy lever actuator for a long service life and a high level of process reliability. Suitable for inside and outside gripping.

- Max. gripping diameter 50 mm
- Gripping force of up to 840 N
- Single and double-acting
- Gripping force backup and support

Everything you need to know about DHxS. **05**

Radial gripper DHRS, angle gripper DHWS



More grip on the production line!

Slim, powerful and with great repetition accuracy, just like its cousins. Suitable for situations where space is limited. And another plus point: the DHRS has a lateral gripper jaw support for high torques, while the link guided DHWS has optimised gripper jaw bearings with synchronised jaw movement.

- Single and double-acting
- Gripping force backup and support
- Self-centring gripper jaws with additional centring option
- Total opening angle DHRS 180°, DHWS 40°

A wide variety of grippers for every task. **06**

Sealed parallel gripper HGPD, sealed 3-point gripper HGDD



Extremely harsh conditions? No problem!

Grippers HGxD are completely sealed, allowing them to withstand even dusty or damp environments without any problem and still grip very precisely. Maximised gripping reliability is guaranteed, even with high torques – especially with the optional opening/closing gripping force backup.

- Total gripping force up to 3,900 N (HGPD) or 3,000 N (HGDD)
- Force pilot operated with repetition accuracy from 0.01 mm
- Tubeless compressed air supply with optional adapter plate
- Highly efficient sensing with protected proximity sensors

Ideal for:

→ www.festo.com/automobil

Radial gripper HGRT



Unshakable: reliable and precise operation.

Keep your grip in every situation. This sturdy radial gripper is characterised by high torque resistance, absolute precision and gripping reliability, even with long gripper jaws. Sealing air keeps it from getting contaminated, while the freely adjustable gripping angle (up to 90° per gripper finger) ensures optimum cycle times.

- Gripping force backup with compression springs in case of pressure failure
- Total gripping torque up to 84 Nm at 6 bar
- Precisely polished plain-bearing guides for reliable gripping

Bellows gripper DHEB



Gripping and inspection in one – a worthwhile investment.

Scratches or cracks? Once upon a time, perhaps. But the single-acting DHEB grips the workpieces safely and gently from the inside. It also checks during transport whether the workpiece is leak-proof. For even greater process reliability, why not choose optional proximity switches or sensors?

- 11 sizes with gripping diameter up to 85 mm
- Upward or downward bellows movement
- Bellows materials EPDM for higher loads or silicone for higher temperatures



For more detailed information, visit our products page:

→ www.festo.co.uk

- 04 DHPS
- 05 DHDS
- 06 DHRS

Get a head start – with valves and valve terminals, from simple to high-end.

High flow rate, versatile, modular and easy to install: VTSA

It's all down to the functional integration: never before has an ISO valve terminal had larger degrees of freedom. The sturdy, highly versatile and modular design of the VTSA has made this valve terminal very popular, especially in the → **automotive industry** – and many other sectors that need to combine standardised products and high flow rates with a high level of flexibility and modular design.

A world first:

the mix of 5 valve sizes on one valve terminal – and no adapter plates required up to size 2!

Safety@Festo:

Profisafe shut-off module
CPX-FVDA-P to
Cat. 3/PLe/SIL3

Diagnostics concept: LED, CPX-MMI (handheld terminal), laptop, maintenance tool, fieldbus/Ethernet, optional web monitor, integrated sensors and electronics

Safety@Festo:

lockable controllers, e.g. with a padlock

→ Safety@Festo:

Unique valve integration for a safe soft start. The soft start valve with quick exhaust is safe up to performance level d in accordance with EN 13849-1

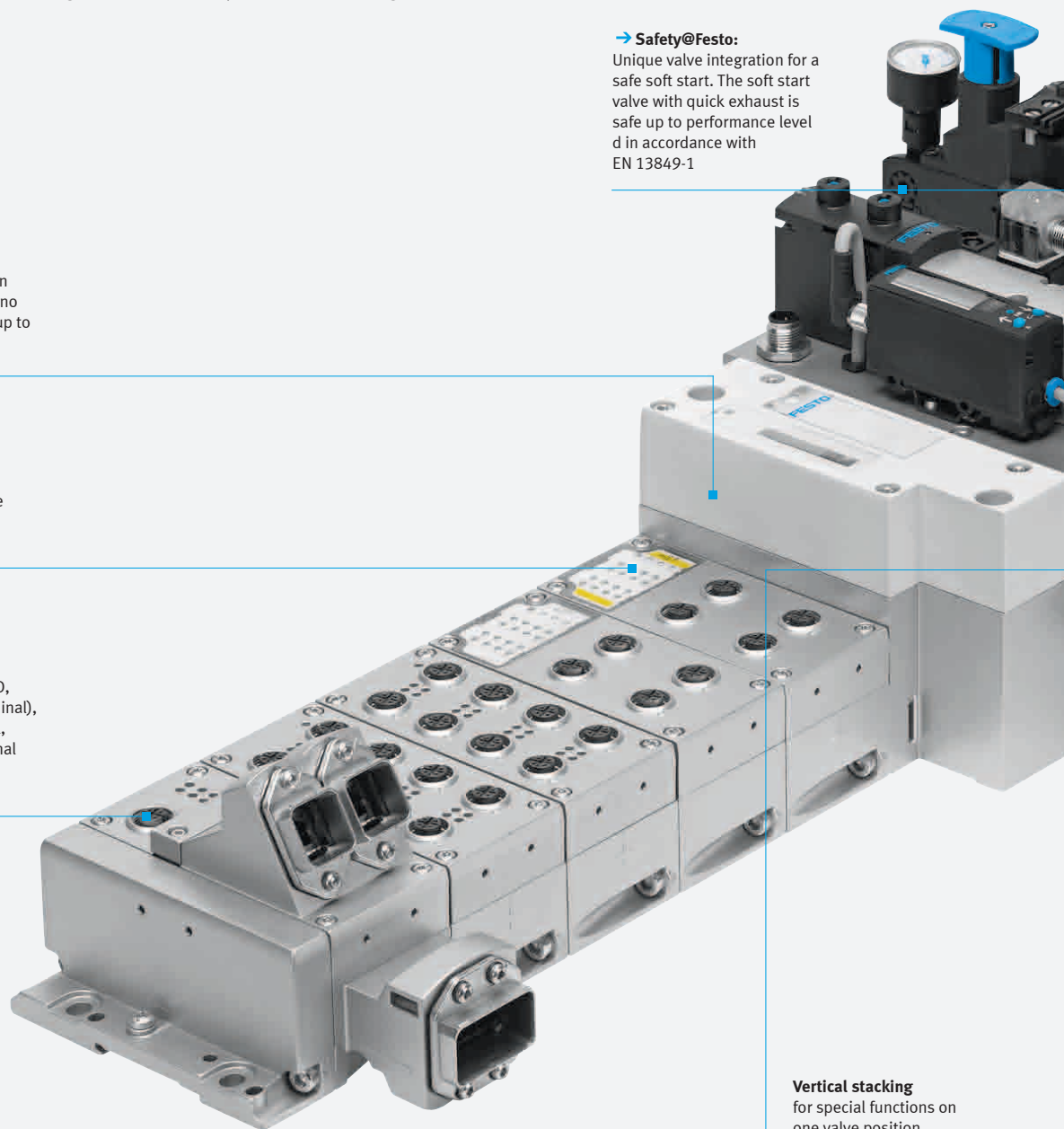

Vertical stacking
for special functions on
one valve position

Since inventing the valve terminal, Festo's product range has remained at the cutting edge thanks to the continuous development of newer and better functions for valves and valve terminals. And we want to maintain this position in order to keep you ahead of the competition.

→ More safety@festo:

15 s. p. 32

Automotive industry:

→ www.festo.com/automotive

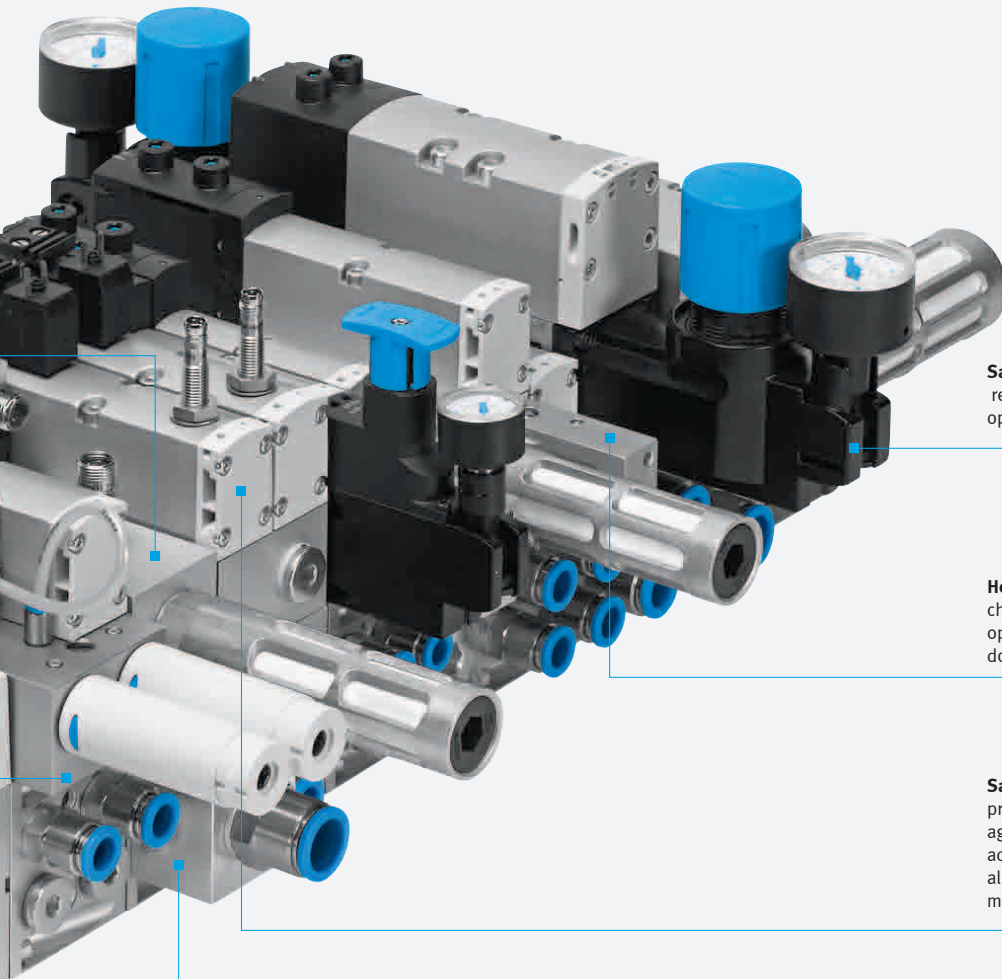

Save up to 50% on energy:
reverse and dual pressure operation

Hot-swap:
change valves during operation to reduce downtimes!

Safety@Festo:
press safety valve guards against unexpected start-up in accordance with EN 1037 and allows reversal of cylinder movement

Safety@Festo:
option for multiple pressure zones

- **Switchable pilot air supply:**
protects against unexpected system restarts up to performance level d in accordance with EN 13849-1
→ **Safety@Festo**



High-resolution analogue module CPX-4AE-U-I



Opens the door to new areas of automation with CPX.

And really boosts your machinery's performance, with four 16-bit channels and a range of new signal types for new applications, e.g. measuring levels, pressures or distances. Includes high protection class, easy integration into valve terminals, system diagnostics via LED.

- More signal types: ± 10 V, ± 5 V, ± 20 mA, 0 – 10 V, 0 – 20 mA, 4 – 20 mA
- High resolution and precision, S7 data format
- Current input overload protection included as standard

Intended for universal use; particularly useful for process automation.

→ www.festo.com/water

Your door to the whole world of CPX.

→ www.festo.co.uk/cpx

Profisafe electronics module CPX-FDVA



Safe, trouble-free shut-off.

Integrated into valve terminals for the first time, CPX-FDVA-P safely shuts off 2 outputs and the power supply to valves MPA and VTSA without any trouble – via ProfiSafe for ProfiNet (CPX-FB33, FB34, FB35). No integration or interoperability problems, no separate authorisation, no wiring.

- Simple planning, engineering and installation thanks to integrated solution
- PL e and SIL3 possible
- Three digital output channels
- All channels are self-monitoring and dual-channel, category 3 acc. to ISO 13849

Makes the automotive industry and large machinery builders in the machine construction sector safer. **07**

Modular electrical terminal CPX-L



Gets your control cabinet in shape. And makes it more cost effective.

Optimised for control cabinets, with a high number of channels in IP20 with unique triple wiring and simple, very cost-effective modules that are still open for high-end modules such as CPX or many fieldbuses. Top tip: really get your money's worth with the remote I/O with harmonised valve terminals from Festo.

- CPX-L-16DE-16-KL-3POL: 16 digital inputs, CPX-L-8DE-8DA-16KL-3POL: 8 digital inputs and outputs
- Fits every time: electrics, pneumatics and drives from a single source
- Diagnostics: short circuit/overload per module, undervoltage outputs

Find out more about our clever ready-to-install solutions here. **08**

Hood CAFC-X1-GAL for CPX

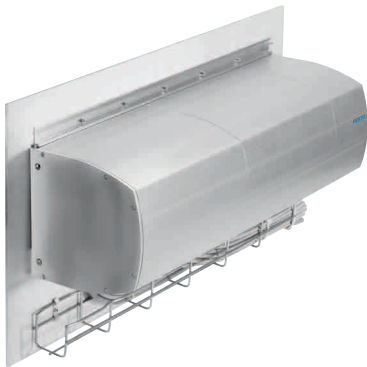

No control cabinet required: make ATEX easy – and up to 70% cheaper.

With convenient and easy installation, the CAFC-X1-GAL enables you to meet the special requirements for using CPX/MPA in ATEX zones with the minimum of fuss. Also available on request as a complete solution from Festo, e.g. as a pre-assembled installation plate.

- 50% – 70% cheaper than a control cabinet
- Up to ATEX Zone 2/22, close to the process
- Space saving; no construction work required
- Alternative to the "pneumatic multiple connector plate"
- Intended for use as an additional safety mechanism

More information on ATEX. [09](#)

Valve terminals MPA-S/MPA-F/MPA-L Valve expansions



Consistently expanded – so MPA can do even more for you.

New: larger proportional-pressure regulator VPPM-MPA 1/4" for precise control of pressure, force, pressure zones or individual pressure.

New: directional control valves for low pressure between –1 and 3 bar, e.g. for holding, pressing in or use in safety engineering.

New: MPA-L – super-modular. Lighter materials and angled cartridges save weight, space and costs.

- VPPM-MPA in nominal diameter 8 for 380 ... 1,650 l/min and on the spot diagnostics
- 2x2/2-way, 2x3/2-way and 5/2-way valves with combined mechanical spring reset and pneumatic spring
- MPA-L: all sub-bases connected individually for greater flexibility, modular in single steps

The full picture – possible areas of application for VPPM-MPA. [10](#)

Valve terminal MPA-ASI extension

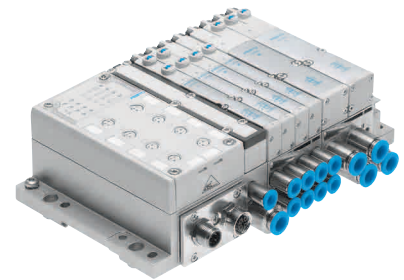

You can now use the compact and modular MPA-ASI in accordance with spec. 3.0 in A/B operation.

Twice as many I/Os as a master! Spec. 3.0. allows address ranges 1A – 31A and 1B – 31B for installation of binary sensors or actuators. This reduces the channel price by up to 50%! Includes all the benefits of the MPA with pressure zones, vertical stacking and diagnostics.

- Design Spec. 3.0, profile 7.F.E. with 4I40/8I80 in the MPA-ASI module 546279
- Required ASI master M3
- 4/8/16 I, 4/8/16 O; bus times 20 ms, 496 I/O or 248 I/248 O
- Wide range of accessories, e.g. cable socket NEFU-X2. Adapted AS interface flat cable with M12 plug

Top products for the ASI master CESA from Festo, top support for the ASI world: so that you can build complete systems. [11](#)

For more detailed information, visit our products page:
→ www.festo.co.uk

- [07](#) CPX-FDVA
- [08](#) CPX-L
- [09](#) CAFC
- [10](#) MPA-S
- [11](#) MPA-ASI

Valve terminals VTSA/VTSA-F Valve expansions

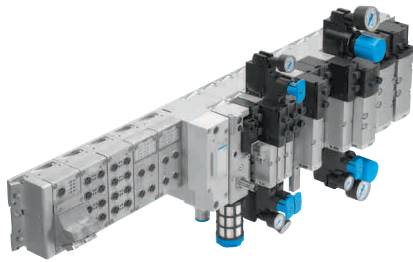

Did you expect our champion to get even better?

New: ISO size 3 makes the VTSA a one-of-a-kind, universal, pneumatic solution package. Suitable for new tasks in the automotive industry, raw materials processing and heavy machine building.

New: more versatile, compact pressurising and exhausting with slow start-up pressurisation.

New for the VTSA-F: valves and manifold blocks in 4 sizes that can be combined into cost-optimising control chains – no adaptor required!

- ISO size 3 to 4,500 l/min flow rate, plus all previously available functions
- Combinable with all valve sizes, from 02, 01, 1 to 2!
- VTSA-F: up to 30% more flow!

VTSA and CPX: watch unique, integrated automation solutions, even in especially harsh environments.

→ www.festo.co.uk/cpx

Function integration safety engineering for ISO valves VSVA/valve terminal VTSA

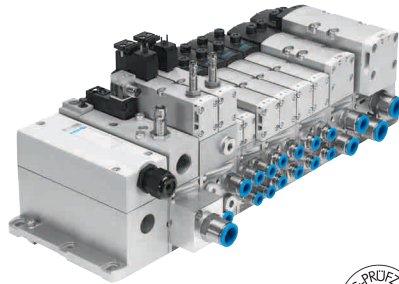

Set new standards by combining safety engineering and economic efficiency – with Safety@Festo.

Functional integration of comprehensive electro-pneumatic safety functions on valve manifolds and valve terminals in accordance with EN 13849-1 saves you engineering and installation time – not to mention money. What is more, it can all be combined with the Profisafe shut-off module on the CPX terminal and the existing valve sizes 02, 01, 1, 2 and 3.

- Safe venting up to cat. 4, PI e with safety valve block VOFA-3/2, ISO Size 01 (26 mm)
- Safe reversing up to cat. 4, PI e with press safety valve block VOFA-5/2, ISO size 01 (26 mm)
- Protection against unexpected start-up to cat. 3, PI d with pilot air switching valve VSVA/VTSA ISO size 01 (26 mm) or 02 (18 mm) with built-in sensor
- Safe stopping, holding, blocking a movement up to cat. 2, PI e with 5/3-way valves VSVA
- Pressure build-up and exhaust valve VABF for controlled, safe pressurising up to cat. 3, PI d

Safety needs training too!

Find out how with our Didactic courses and training programmes:

→ www.festo-didactic.com

Safety@Festo: [12](#)

Valve terminal VTOC

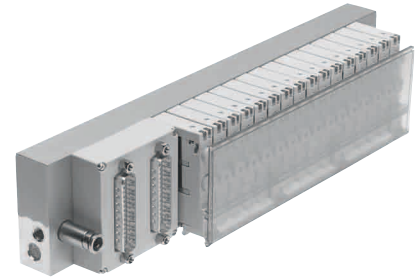

For when you need extremely reliable pilot control of process valves.

Ideal for the semicon, photovoltaic, flat-panel display, biotech/pharmaceutical and the processing industry. Incredibly safe, especially in gas boxes, as the conductive tracks and plug connectors always run separately and each coil has dual-pole activation. Versatile electrical connection technology included!

- Up to 48 3/2-way valves per valve terminal
- Space-optimised with 2 x 3/2-way valves per valve position
- Configurable and with manifold rail
- Range of mounting options

Complete solutions for individual sectors.

→ www.festo.com/solar

Low-cost valve series VUVG/VTUG

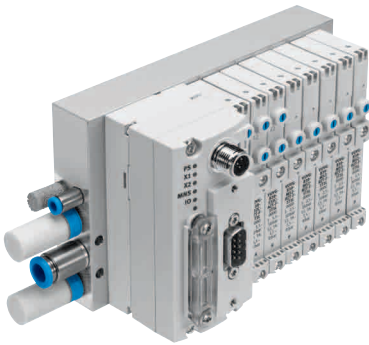

The best valve in its class receives reinforcements!

Valves VUVG and valve terminals VTUG – a complete series from individual valve to fieldbus-compatible valve terminal. With characteristics you will appreciate: cost-effective, high flow rates, compact design and impressively simple. Wherever you need high flow rates at a very low-cost and small volumes, such as in a control cabinet.

Valve terminal VTUG

- Multi-pin, IO-Link or low-cost, universal fieldbus nodes CTEU
- For use with CanOpen, DeviceNet, Profibus, ASi, Ethercat plus IO-Link
- Easy installation and commissioning

Individual valve VUVG

- 2 x 3/2-way valves in one valve
- Multiple pressure zones can be easily set up
- Electric and pneumatic actuation

Find the right valve terminal easily and reliably thanks to pre-selection and the valve terminal configurator. [13](#)

Bus nodes CTEU

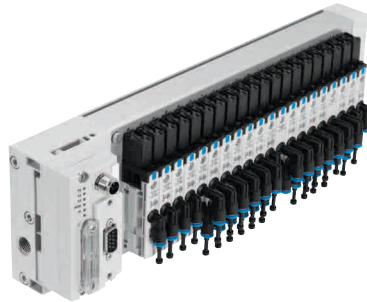

Irresistably simple and low-cost fieldbus technology.

Now both multi-pin and fieldbus compatible: VTUB with low-cost, universal fieldbus nodes CTEU for valve terminals such as VTUG and VTUB. This means you get a fieldbus-compatible valve terminal for the price of a multi-pin solution. The Festo "I-port" also gives you an extremely versatile communication interface.

- Outstanding price/performance ratio: CTEU with valve terminals VTUG or VTUB
- For use with CANopen, Profibus, DeviceNet, ASi, Ethercat plus IO-Link
- Simple, versatile design: minimised warehousing, optimised logistics

Reliable operation: pneumatics and electrics from a single source are the perfect solution when using our engineering tools and the circuit diagram software FluidDraw. [14](#)

Proportional pressure regulator VPPM



When high-tech meets user-friendliness.

VPPM has everything you need for reliable, precise control: 3 presets and a sturdy multi-sensor control system with a multi-level control circuit. Display and operation are made easy thanks to the LED or LCD with a wide range of editing functions. Also available now: the brand new, slim 1/4" variant.

- Inline or flange version, current or voltagecontrolled
- Flow rates: 380 ... 2,750 l/min
- Pressure range: 0.02 ... 2 bar, 0.06 ... 6 bar, 0.1 ... 10 bar
- Connection sizes: G1/8, G1/4, NPT or flange

Know-how for proportional pneumatics. [15](#)



product
design award

2012 ■

For more detailed information, visit our products page:
→ www.festo.co.uk

- [12](#) VTSA
- [13](#) VTUG
- [14](#) CTEU
- [15](#) VPPM

Combines optimum flow rate and compact design



reddot design award
winner 2009

The mix of sizes in the MS range offers you important benefits, such as the cost and space optimisation of the MS6 and MS9, and up to 600% more flow.

Almost limitless: the MS series

From highly sensitive application in the pharmaceutical and food industries to application-specific solutions that require sturdy flow power for the automotive industry, the service units in the MS series can be used almost universally, whether as centralised or decentralised solutions.

Technology with a savings effect

With its specifications of 6 bar of pressure, a flow rate of 5,000 l/min and a grade of filtration of 0.01 µm, the service unit shown here can save you up to 30% on component costs and 18% on installation space!

**Find out more here:**

- Tools for selecting components and for dryer calculations
- Free configurator for fast, reliable engineering and ordering
- Information on compressed air quality in accordance with ISO 8573-1:2010, ISO classes, energy efficiency, integrated sensors, safety functions and the benefits of ready-to-install solutions.
- Services such as compressed air quality and consumption analysis ...

Absolutely everything you need to know about outstanding compressed air preparation:

→ www.festo.co.uk

Service units MS: new size MS 9



600% more flow for your service units = maximised efficiency!

Replace the filter in your service unit MS6 with the new size MS9 and optimise the flow rate of your entire combination.

This especially applies to fine (LFM-B), micro (LFM-A) and activated carbon filters (LFX).

- Low-cost mix of sizes
- Longer service life for fine and micro filters thanks to pre-filtration with MS9-LF
- Different compressed air qualities thanks to the new distributor module MS9-FRM

Are you familiar with our Energy Saving Services? Save money right from the first day. [16](#)

Safety valves MS6 / MS9 with Performance Level C



Good, low-cost, high-performing: certified safety, tailor-made for you!

Ideal for applications with performance level A, B or C: safety valves MS6-SV-C or MS9-SV-C. The simple, single-channel design enables safe, fast exhausting – and is also very cost-effective.

- For safe exhausting with no residual pressure
- Meets Performance Level C acc. to DIN EN ISO 13849-1
- Flow rate 2 → 3: MS6-SV-C: 6,000 l/min, MS9-SV-C: 15,000 l/min, Pressure 3 ... 16 bar

Safety valve MS6-SV-ASIS with Performance Level E



The unique, certified safety valve with an ASI safety connection.

The redundant MS6-SV-ASIS is designed for 100% safe exhausting, with soft start, hourly self tests, diagnostic functions and error confirmation. The built-in pressure sensors enable the unit to sense the input and hold pressure P1 → P2 via the bus – no additional safety relay required!

- For safe exhausting with no residual pressure
- Certified according to DIN EN ISO 13849-1 for cat. 4, Performance Level E
- Flow rate P2 → P3: 9,000 l/min, Pressure 3.5 ... 10 bar

Safety@Festo: use this keyword to find out all about safety issues. [17](#)



Water separator MS9-LWS



99% condensate separation – a top figure that you could never achieve with a conventional filter.

The secret: the water separator MS9-LWS separates the condensate with an optimised centrifugal separator.

The product is maintenance-free, economical and energy-efficient.

- Small size, great performance: flow rates up to 15,000 l/min
- pressure range 2 ... 12 or 0.8 ... 16 bar
- Fully automatic condensate drain, also with electrical actuation

Save operating costs right at the source – with an energy analysis of compressed air generation. [18](#)

One-way flow control valve GRLSA with scale



Simple, fast, time-saving and with reproducible flow.

Clear and comprehensible, ideal for total productive maintenance: the setting scale defines and documents the values clearly and reliably. It ensures precise, simplified flow rate regulation and quick and easy commissioning, also thanks to QS fittings.

- Flow rate q_N: GRLSA-1/8-QS-6: 300 l/min; GRLSA-1/4-QS-8: 450 l/min
- Simple handling, fast connection
- Fixed offset with digital and analogue function in one component

Fast, precise (pre-)setting of the piston speed: that's cost efficiency! [19](#)
Total productive maintenance from a new angle: a Festo Didactic course. [20](#)

Suction gripper OGGB



Transports your delicate wafers safely, quickly and gently.

The gripper with built-in vacuum generator operates on the Bernoulli principle and is virtually contactless. The workpiece floats on an air cushion and only comes into contact with the gripper at the few stops. The stops are made of elastomer for higher lateral forces.

- Low-contact, low-impression handling of delicate, fragile, thin, pliable workpieces
- Quiet operation

Also ideal for the photovoltaic industry (wafers, solar panels), semiconductor technology and the computer industry, wind power and automotive/lightweight construction.

→ www.festo.com/solar

For more detailed information, visit our products page:
→ www.festo.co.uk

- [16](#) MS9
- [17](#) MS6/MS9
- [18](#) MS9-LWS
- [19](#) GRLSA
- [20](#) GRLSA

Land right on the spot with: clever control architecture

Make things easier with software tools

- Convenient configuration: Festo Configuration Tool FCT
- Convenient communication: Festo profile for handling and positioning tasks FHPP
- Convenient and versatile programming: programming platform CoDeSys – provided by Festo and standardised in accordance with IEC-61131-3
- Convenient teaching and intuitive programming: Festo Teach Language FTL
- For everyone who likes their control system to be directly integrated into their screen: CDPX

Small, compact, low-cost:
compact controller CECC

**Simple programming
and navigation** in accordance with
IEC-61131-3

Decentralised intelligence:
from small-scale controllers to
complete control solutions

Useful for
→ small parts assembly and
electronics



Excellent performance:
controller CPX-CEC with
400 MHz 32-bit processor

Versatile:
from remote I/O to
modular PLC in IP 65/67

Efficient:
stand-alone open and
closed-loop control

Pre-processing

**Ideal for motion
applications** with up to
31 electric drives

Clearly tailored to suit your application, optimally integrated into your control or management system – our control architecture fits perfectly into your overall system, whether for actuating electric, servo-pneumatic or pneumatic drives.



Powerful:
modular controller CECX

For PLC functions and multi-axis movements
with interpolation in 2.5 degrees of freedom

Simple commissioning,
programming and servicing
thanks to CoDeSys with
SoftMotion module



Modular:
robotic controller CMXR

Highly functional:
3D interpolation, 2D and
3D permanent path
control, point to point
synchronous

Simple programming
with Festo Teach Language FTL

→ A whole world of
software tools
25 s. p. 39

Small parts assembly
and electronics
→ www.festo.com/small_parts_assembly

Flow sensor SFAM-90



High flow rate, compact – and an early starter.

Used either as a stand-alone unit or with service units MS9, the SFAM-90 can be adapted perfectly to suit your application. The wide spectrum of flow ranges – from 50 ... 5,000 to 150 ... 15,000 l/min – offers a huge array of measuring values. And the large measuring range always supplies absolute flow information with threshold values.

- Unidirectional: choice of fluid flow via modules
- Fast installation: with innovative prism clamping technology
- Convenient, bright LED display with adjustable colour makes it easier to set the switching point

A whole world of compressed air preparation.

21

Pressure transmitter SPT E



Need something simple and small, but versatile too?

Then you need the SPT E.

With its versatile mounting options and stripped down to the basics, it is ideal for pressure or vacuum monitoring on valves and cylinders. Especially in situations with restricted fitting space that require high component density, the small size and low weight are perfect.

- Flexible: 3 attachment concepts for fast, low-cost mounting
- Simple click-mounting and dismounting – no tools required
- Compact 8-bracket wall mount for manifold assembly

Ideal for small parts assembly and use in the electronics industry. 22



product
design
award
2011



reddot design award
honourable mention 2011

Pressure transmitter SPT W



Every type of fluid: SPT W allows you to monitor even gaseous and liquid media.

Whether using pressure or vacuum sensing, the sealless, stainless steel design of the SPT W is sturdy and resistant to all media that do not attack the measurement cells and housing – perfect for high-pressure pneumatics and monitoring the pressure of fluid media.

- Versatile: excess pressure measurable in 7 variants up to 100 bar
- Combined over and underpressure –1 ... 1 bar and –1 ... 10 bar
- No seals: pressure measurement cell and all fittings in stainless steel

Also useful for process automation. 23

Connecting cables NEBU



Making life easy for you: the rotatable socket NEBU.

Tight fitting spaces? No problem! The infinitely rotatable NEBU socket allows maximum flexibility when electrically connecting sensors or actuators.

- Convenient: very easy electrical connection
- Flexible: cable output in any direction
- Application-orientated: e.g. for re-adjusting sensors at a later date

Graphic display and operating unit CDPX



The next-generation display that is also a server.

Powerful processors are combined with widescreen technology for a greater functionality, higher resolution and a variety of tasks. Perfect graphic displays, simple, intuitive project planning and programming with Designer Studio – the complete package for man-machine applications.

- Visualises data and acts as a server for external clients all around the world
- Ethernet interface for simple networking
- Displays data and parameters from third party Modbus devices

CDPX expanded into a compact control concept with CoDeSys V3. [24](#)

Compact controller CECC



When you want a compact mini control system with more functions.

The CECC enables simple activation of electric or pneumatic drives, especially for small tasks. It can be used as a stand-alone unit or conveniently integrated into mechatronic solutions via the platform CoDeSys V3 provided by Festo. Simple programming and navigation in accordance with standard IEC 61131-3.

- Hybrid: use CANopen Master and integrated IO-Link to directly activate electric and pneumatic drives and connect valve terminals
- Communicative: easy integration into higher-level systems via ProfiNet, Ethernet IP and Modbus TCP
- Convenient: simple data handling with USB interface

More on the IO-Link at Festo. [25](#)

For more detailed information, visit our products page:
→ www.festo.co.uk

- [21](#) SFAM-90
- [22](#) SPTE
- [23](#) SPTW
- [24](#) CDPX
- [25](#) CECC

Automation solutions for water technology

A hard job, and extremely energy-intensive: here in the pumping station is where the most power is supplied to the wastewater treatment plant. For Festo, this was reason enough to develop its own solution. It was a roaring success: power consumption in the entire plant in Sindelfingen/Germany was thus reduced by 2%, or more than €11,500 per year.

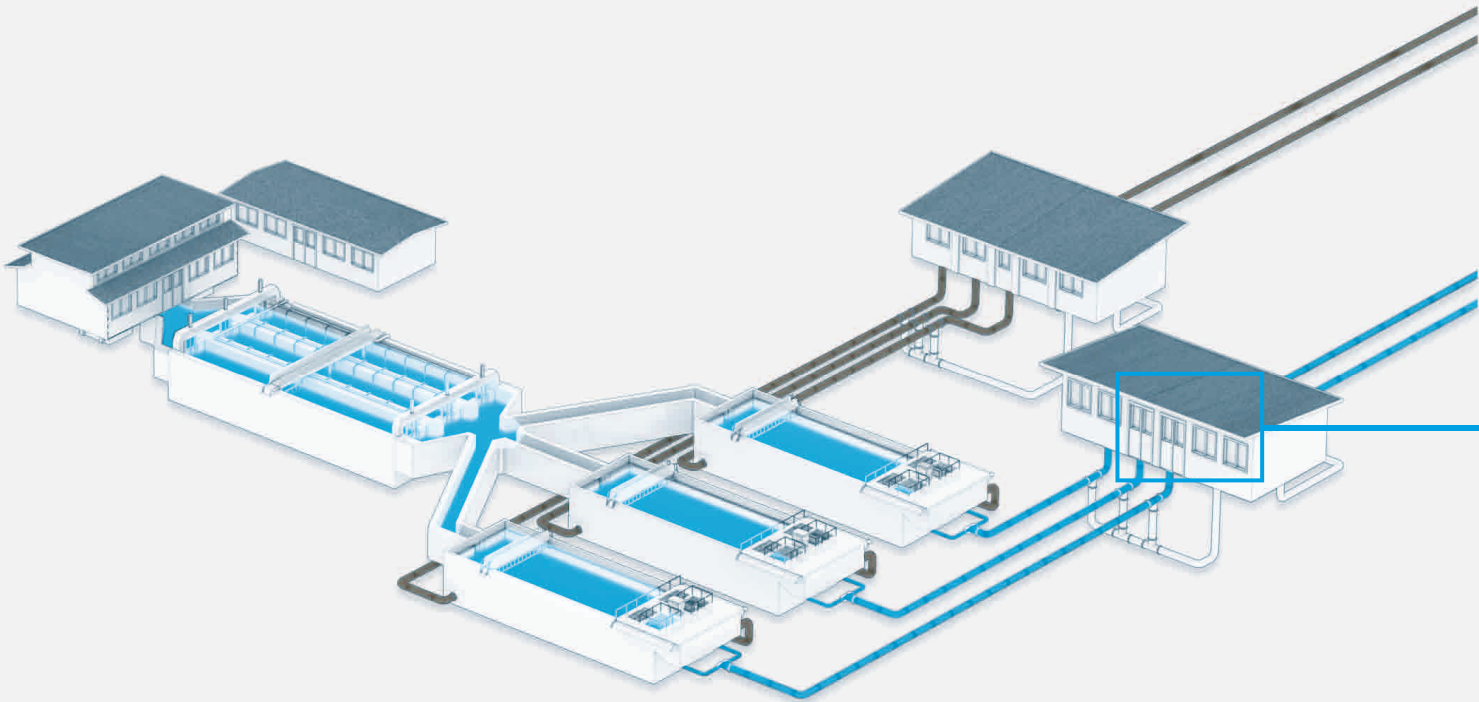

The figures

In the pumping station, the wastewater from the primary sedimentation tank to the biological treatment.

- Treatment capacity: equivalent to population of 250,000
- Operating specifications: 6 pumps, up to 5 pumps constantly in operation, 1 redundant. Pipe diameter: DN 350
- Pump specifications: rated output 90 kW, pump capacity 500 l/s with 8 – 9 m discharge head
- Energy savings: 89,469 kWh per year
- Cost savings: 11,594 Euro per year

The solution

Automated slide gate valves with quarter turn actuators DLP and directly mounted Namur valves NFV3 replace the conventional non-return valve with flap. The automated unit can be controlled via a centralised or decentralised PLC.

7 months was how long it took

for the additional costs of this investment to be recouped. From this point on, the solution will effectively be saving money.

The pumping station is the best possible proof that pneumatics are an energy-efficient alternative for water treatment plants. This is where the wastewater is pumped to the anaerobic treatment or the biological filters.

- **Lower energy costs** – because the pump doesn't need to overcome any flow resistance
- **Increased operational reliability** – the pump's function is not impaired by unwanted cavitation
- **No damage to the pipe system** – as water hammer is avoided
- **Longer service life for system 1** – because there are no unwanted vibrations
- **Longer service life for system 2** – lower wear on the slide gate valve
- **Backup reservoir** – a compressed air reservoir shuts down automatically in case of power failure. Operation continues seamlessly
- **Tightly closing valves** prevent leaks
- **Clear structure** and more compact
- **Less noise:** much quieter operation
- **More efficient and reliable pneumatics:** resistant to constant strain, no maintenance required, simple installation, sturdy and temperature-insensitive

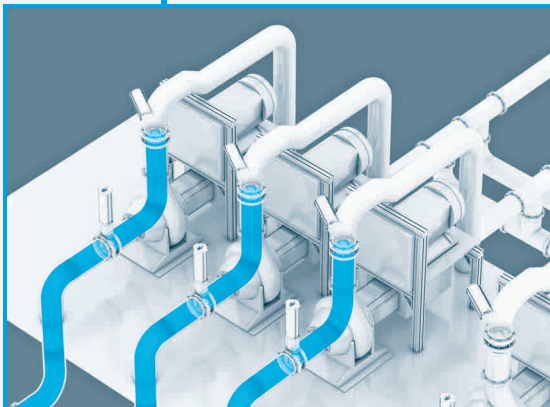

"The decision to use Festo pneumatics at this point is a decision for reliable technology and simple installation. And also for saving energy in ways I never imagined were possible."

Hartmut Zerrer,
Water treatment plant manager
Böblingen-Sindelfingen

More on this topic:

→ www.festo.com/water

- Wastewater treatment
- Wastewater pumping station

Servo-controlled solenoid valve VZWP

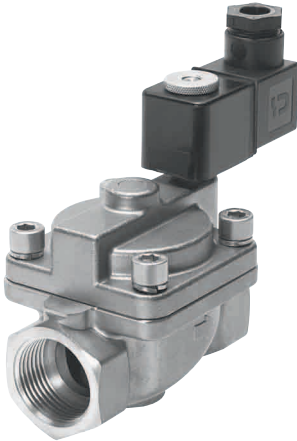

Open the door to new applications with a greater operating pressure range – of up to 40 bar.

VZWP is the latest addition to the solenoid valve series VZWM. The VZWP uses a sealing piston instead of a diaphragm, allowing it to control high pressures with large nominal diameters. It is ideal for use with gaseous and fluid substances up to a viscosity of max. 22 mm²/s in production and process automation.

- Brass valves with a choice of NBR or FKM seals
- N/C function closes the solenoid valve in case of power loss
- Intended for use with open media circuits with a differential pressure of min. 0.5 bar

Directly actuated solenoid valve VZWD



Doesn't let you down, even with high pressures and low flow rates.

The VZWD even works in closed media circuits with no differential pressure up to 90 bar, making it ideal for high-pressure cleaning and dosing, gas supply to DIN EN 161 or safety shut-off functions. As it does not have any control boreholes, it even works when slightly contaminated.

- Valve switching from 0 to 90 bar; vacuum technology up to 100 mbar
- Works with water, air and neutral media up to a viscosity of max. 22 mm²/s
- Integrated N/C-function

Force pilot operated solenoid valve VZWF



Small and energy-efficient: simply use the energy of the medium.

The force pilot operated VZWF can thus control high pressures with high nominal diameters using relatively small solenoids – even in closed media circuits with no differential pressure. It activates even at 0 bar and automatically closes when the pressure drops, thanks to the N/C function.

- Intended for use with air, gaseous and liquid media with a viscosity of max. 22 mm²/s
- Intended for use with water, air and neutral media
 - Intended for filling systems (secondary circuit), water treatment, heating circuits, etc ...

Angle seat valve VZXF



Incredibly sturdy and resistant – a valve you can rely on.

The universal VZXF for process automation is ideal for controlling gaseous or liquid media flows in closed or open circuits, whether heavily contaminated media up to max. 22 mm²/s viscosity, highly viscous media up to 600 mm²/s or steam.

- Highly heat-resistant, stainless steel design
- Closes reliably when pressure drops thanks to N/C function
- Gas "with the media flow", fluids "closing against the media flow"

Proportional media valve VZQA



Negligible flow resistance, no blockages: a clear run for your media.

The 2/2-way valve controls flows of substances such as granulates, fluids containing solid particles and highly viscous and abrasive media. The housing is corrosion-resistant to CRC4. Maintenance is quick and convenient thanks to easily replaceable sealing cartridges – no special tools required.

- Modular compatibility of component parts
- Clean design for machine cleaning
- Direct air supply connection – no drive required

2-way ball valve VZBA



Full opening for high flow rates: VZBA makes your system piggable.

Intended for use with air, gaseous and liquid media. New: allows connection through welded ends, e.g. for welding the ball valve to a reservoir. The VZBA can be retrofitted with a pneumatic quarter turn actuator.

- Stainless steel or coated brass, depending on the type of ball valve
- High operating pressures:
 - brass 1/4 ... 1 1/4": 40 bar,
 - 1 1/2 ... 2 1/2": 25 bar;
 - stainless steel 1/4 ... 4": 63 bar

A whole world of services. [26](#)



For more detailed information, visit our products page:
 → www.festo.co.uk

3-way ball valve VZBA



Whenever you need a 3-way function: VZBA.

Do you need an L-shaped hole or a T-shaped hole in the ball? You need to make this decision yourself. One advantage of an L-hole is the ability to switch two media circuits using a single ball valve. A T-hole enables mixing processes to be carried out – but not without overlapping. Intended for use with air, gaseous and liquid media.

- Stainless steel or coated brass
- Can be retrofitted with a pneumatic quarter turn actuator
- High operating pressures:
brass 1/4 ... 1 1/4": 40 bar,
1 1/2 ... 2 1/2": 25 bar;
stainless steel 1/4 ... 4": 63 bar

2-way flange ball valve VZBC



Save space in your system with the compact VZBC.

Its compact design makes the VZBC the baby of the flange ball valve family. Nevertheless, it performs just as well as its larger cousins when opening and closing media flows such as air, gas or liquid media as it has a full bore. To top it off, the valve is also piggable.

- Stainless steel housing and ball
- For high operating pressures: DN 15 ... 50: 40 bar, DN 65 ... 100: 16 bar
- Can be retrofitted with a pneumatic quarter turn actuator

Ball valve drive unit with 2-way ball valve VZBA



Increase your process reliability – and save time.

The pre-assembled VZBA offers many advantages, e.g. our standardised design with optimised torque curve and nominal pressure, and with accurate mounting for a cavity-free open position with no offset. Operationally tested with full ATEX compliance – and a single part number.

- Optimised design reduces the need for adapter accessories
- Fast installation in the customer's application
- Wide range of variants, with rack and pinion or lever swing principle

Take advantage of ready-to-install solutions. [27](#)

Ball valve drive unit with 3-way ball valve VZBA



Optimise your engineering, purchasing and logistics

with pre-assembled ball valves. The 3-way-version shares all the benefits of the 2-way variant, allowing two media circuits to be opened alternately via one ball valve. The ATEX-compliance for the entire unit guarantees proper discharging.

- Choose from a selection of one and two-way units
- Operationally tested units
- Complete documentation available on the support portal: www.festo.com

Here you will find services that will help you at every point throughout your value added chain. [28](#)

Ball valve drive unit with 2-way ball valve VZBC with a compact flange connection



When space is tight.

The VZBC with compact flange connection saves space, but still performs just as well as its larger cousins when opening and closing media flows such as air, gas or liquid media. It has a full bore for high flow rates and is delivered as an inspected unit to help streamline your entire value added chain.

- No need for the customer to set up the actuator themselves
- Uniform design for all units
- Design optimised for torque curve and nominal pressure

Namur valve VSNB – Ex-ia

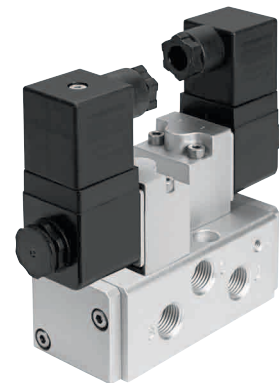

You choose how to use the VSNB.

As a very low-cost, pure valve with Namur interface to VDI/VDE 3845. Or with an intermediate solenoid plate and coil for pilot control. The lower output Ex-ia coil is a new addition to the range. This guarantees connection to all conventional output modules.

- CNOMO interface on the basic valve for using different pilot valves
- Pilot valve modules with different voltages
- Ex-ia pilot valve
- Pre-assembled combination of all valves with Ex-ia pilot valve

Learn process automation and control technology with systems. [29](#)



For more detailed information, visit our products page:
→ www.festo.co.uk

- [27](#) VZBA
- [28](#) VZBA
- [29](#) VSNB



→ www.festo.co.uk

Follow this link for more extensive, in-depth information on products and services from Festo.

