

The new standard: valve range VUVG

FESTO

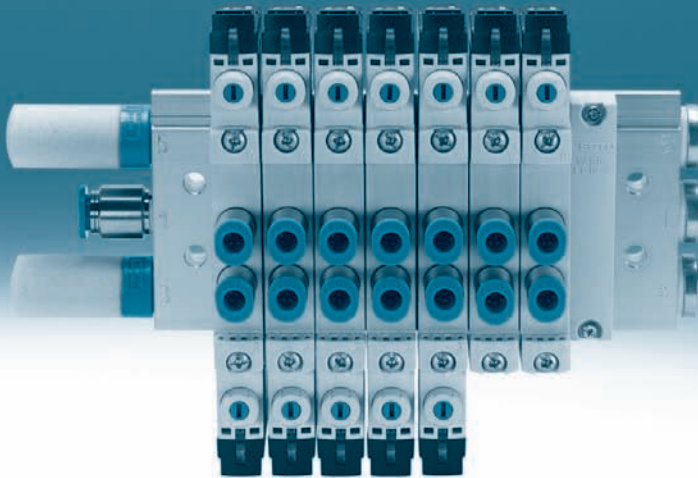

The better alternative!

Highlights

- Extremely long service life
- Smallest possible dimensions
- Very quick and easy installation
- Easy ordering
- Pressure range -0.9 to 10 bar
- Wide range of variants
- Multiple pressure zones can be easily implemented

The VUVG is setting a new benchmark for solenoid valves. It makes applications easier and less expensive. Its small footprint with its high flow rate to small size ratio makes it the best in its class. And of course it is easy to order, install and commission. In other words, you couldn't choose a better valve.

More performance – less space!

Up to 100% more flow, greater energy density and minimised space requirements: for more and faster applications with just one valve type! This also means logistics and ordering costs are reduced.

Patented cartridge seal concept

For new dimensions: Festo cartridge seals enable more functions from one valve design, including vacuum. Its low wear

characteristics deliver long service life and greater reliability.

Easy to order, easy to install

Easy, reliable and quick installation thanks to retained mounting screws, integrated positive-locking seal, and a great range of pre-assembled cables and electrical connectors. No brackets or adapters are needed for individual valve mounting.

Festo: ingenuity in practice!



reddot design award
winner 2009



product
design
award

2010 ■

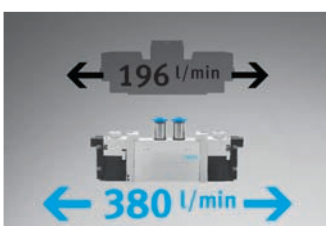

Best Footprint!

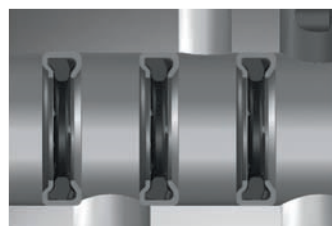

Long service life!



Easy to install!

www.festo.com

Best in class: the footprint.

Higher performance in less space!

VUVG: more compact

The VUVG is a great option for everyone who wants to keep things small or boost performance without increasing size. It has up to 100% more flow and greater energy density

thanks to a pressure capability of up to 10 bar. This means more applications can be operated using a single valve type, which in turn benefits logistics and ordering processes.

- Higher flow rates for shorter cycle times
- Compact design allows attachment directly to the cylinder
- Greater functional density requires less installation space

Two 3/2-way valves in one body – just one VUVG is required to operate two single-acting cylinders. With other solutions, you'd have to order two 3/2-way valves!

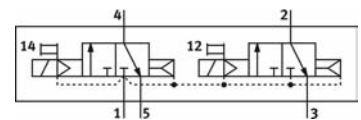
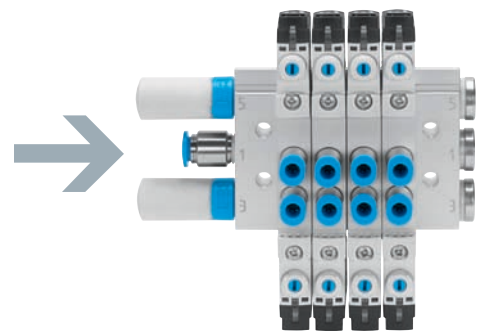
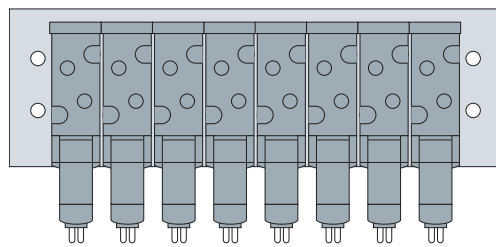

VUVG: simpler, smaller, better performance

Same size with better dynamic response and up to 100 % more flow.

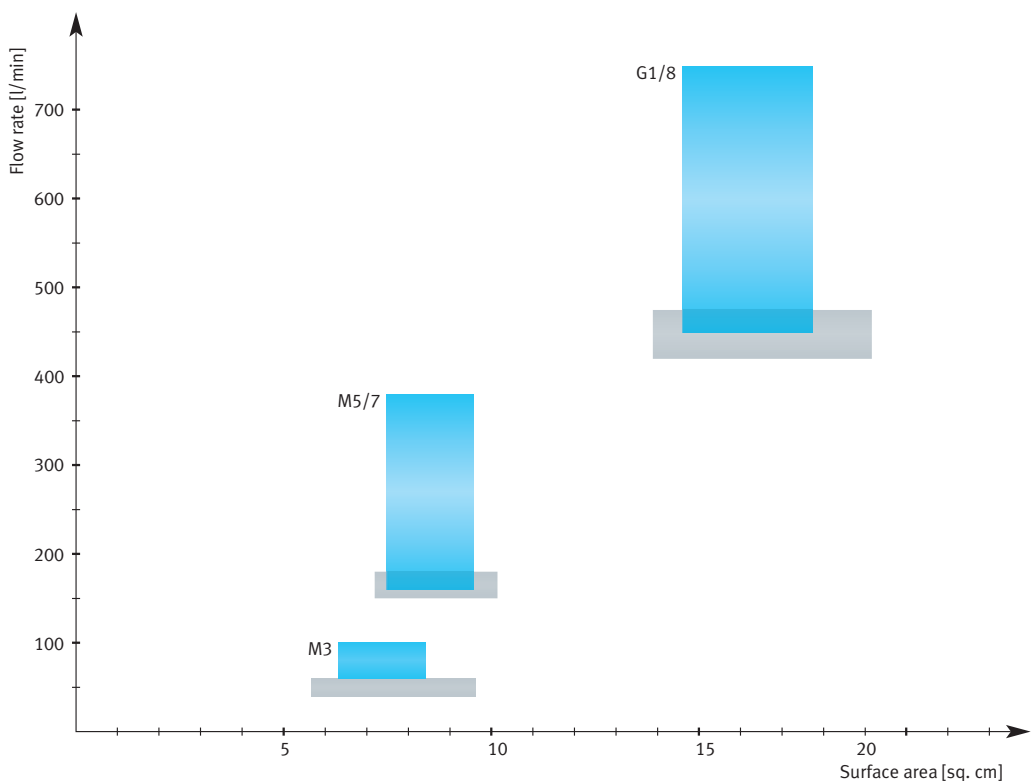

VUVG
Competitors' valves

VUVG: ideal for 10 bar technology

Higher pressures enable smaller valves and actuators offering reduced costs. For more power – and new applications too!

- Higher power density for intelligent downsizing with smaller cylinder sizes
- Pure dynamics: faster cycle times, raised pressure and smaller cylinders

It pays for itself: pressure booster DPA

More power and better dynamics – but only where it is really needed. System pressure can be inexpensively doubled to a maximum value of 16 bar with

the pressure booster DPA. Always precisely at the point of use.

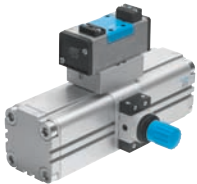

Faster cycle times!

Quicker action – greater productivity with faster advancing times!

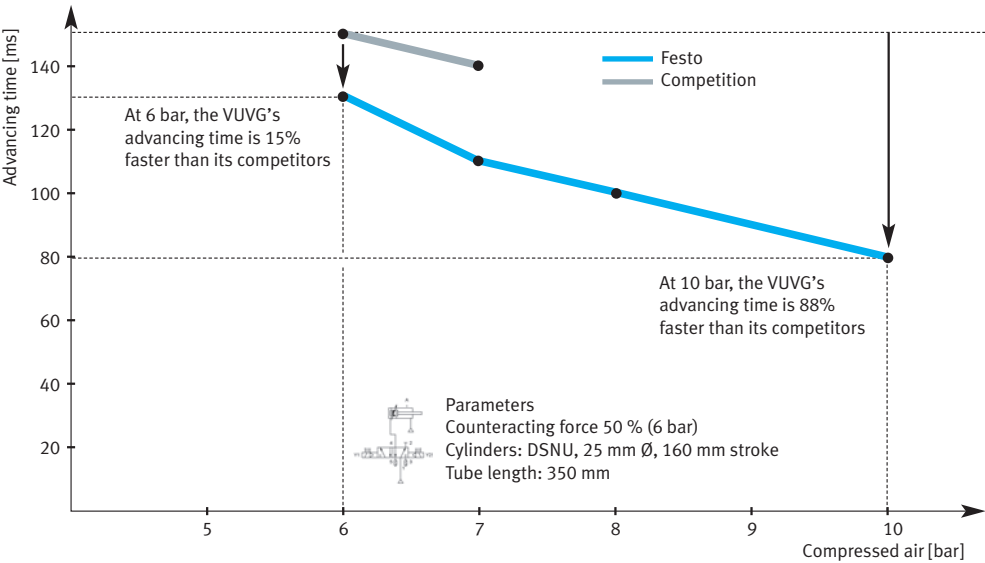

Increase the pressure!

More pressure = more power or a smaller cylinder size!

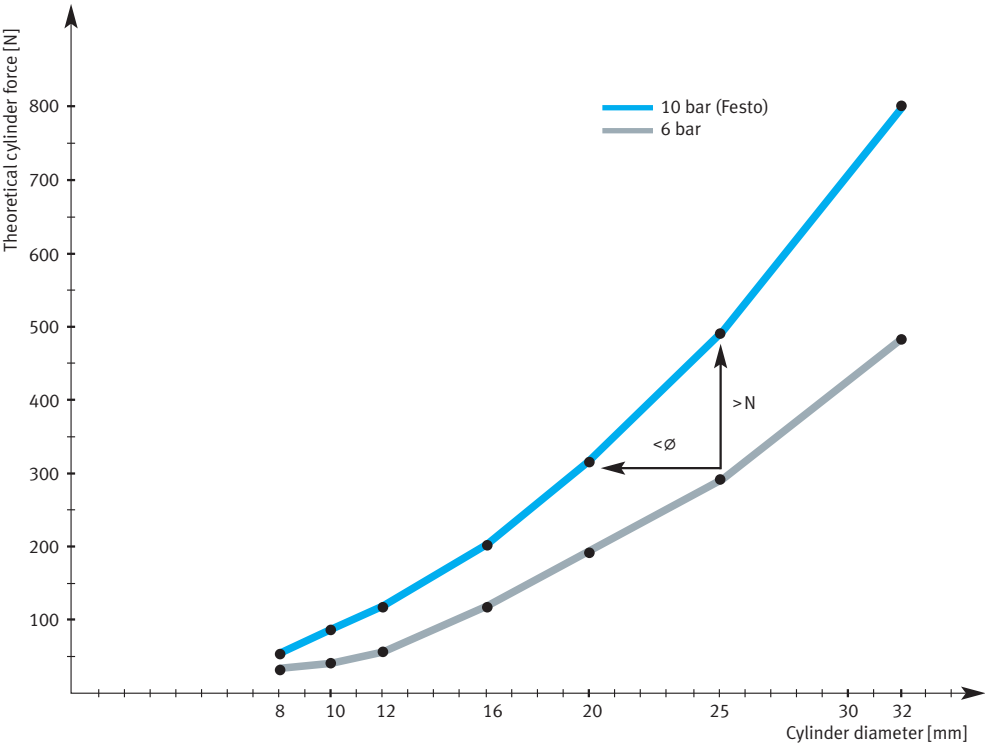

The cartridge concept – more performance more easily

Cutting-edge technology

The patented cartridge seal concept with its unique seal profile and materials makes the VUVG the highest performing, most versatile valve in its class – with longer service life to boot.

- Up to 100% more flow with an extremely small footprint
- Smaller valves with greater flow rates = reduced costs
- Higher pressures of up to 10 bar for maximised energy density and more power

- Vacuum compatible!
- Reversible – two pressures at a single valve at the same time
- Higher temperatures up to 60 °C!
- Non-overlapping – absolutely reliable separation of the air ducts during dual pressure operation
- Minimal leakage

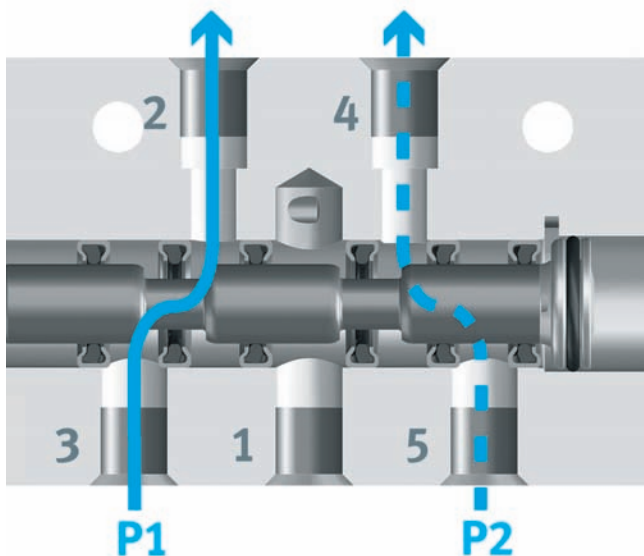
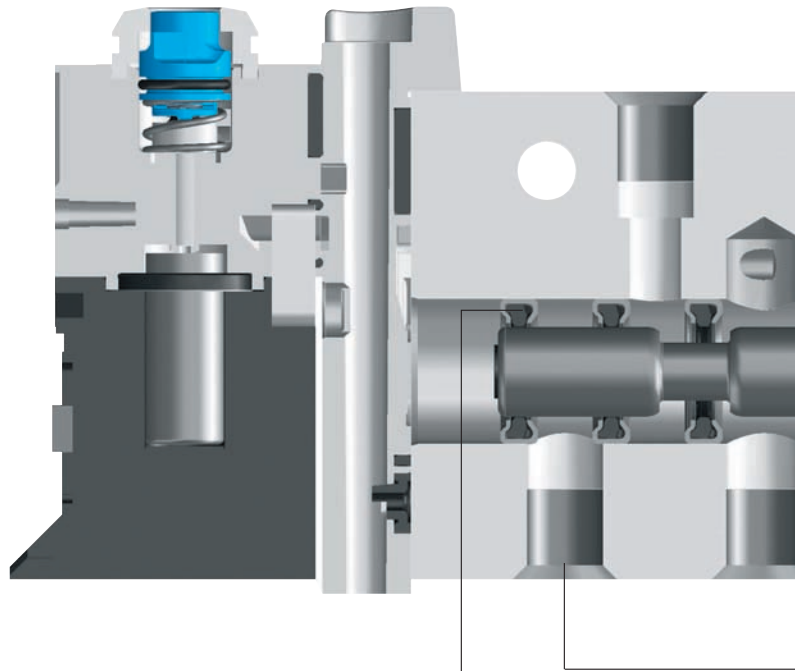

Neatly separated pressures means that overlapping between the air ducts during dual-pressure operation, common in other valves, doesn't happen with the VUVG.

Patented: the cartridge. Design, layout and materials ensure exceptionally high performance.

Non-overlapping: stable, resistant materials and positive-locking spool positions provide rugged reliability.

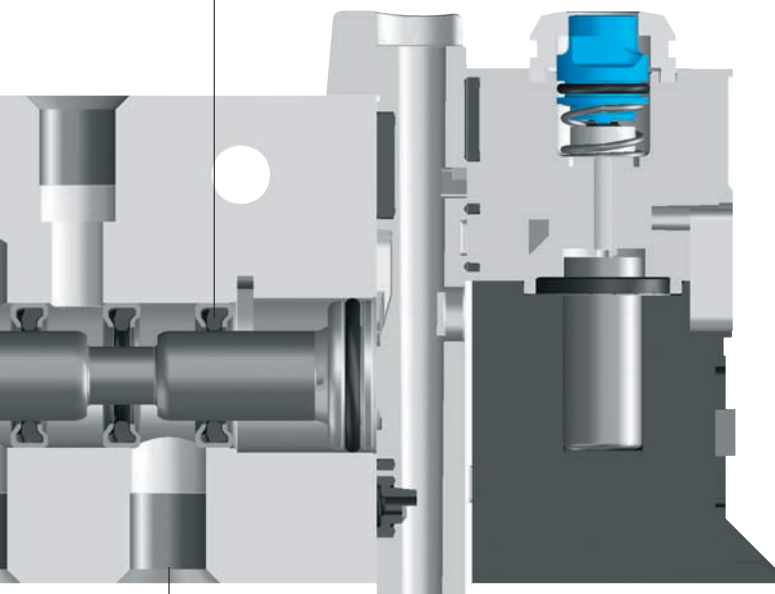

Reversible: two pressures in a single valve (ports 3 and 5) – exhaust air flows through port 1.

Additional technical features

- Integrated LED: 360° view for fast, reliable diagnostics.



- Numerous connection options for optimum integration into system concepts.

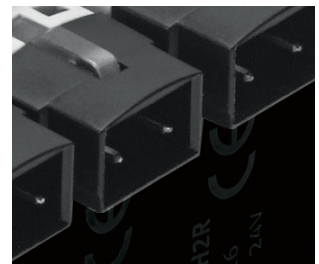

- Lighter body: weight-optimised aluminium housing (2.7g/cm³), ideal for dynamic applications. Considerably lighter than “standard” zinc bodies (7.1g/cm³).

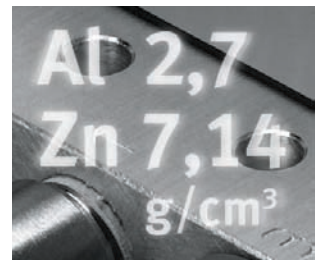

- Internal and external auxiliary pilot air can be selected at the manifold block – reduced number of variants, one single part number!



- Mid-position valves and double pilot valves are equally compact.



Ingenuity in practice!

Easy to install, easy to buy

Top throughout the entire value creation chain

The VUVG is not only excellent in operation, but in other areas too. Where else can you find a standard valve with retained mounting screws, an integrated positive-locking seal, and an E-box which is installed with a single click?

Our philosophy of being more ingenious applies to all stages of your value creation chain and has decisive advantages for you.

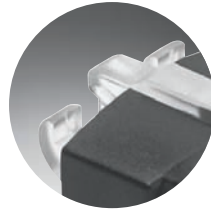

Standard equipment: manual override for easy commissioning.

Click! Just snap it in and it's done. E-box with patented contact system.

Retained mounting screws: robust, secure mounting, no lost parts.

Integrated LED: 360° view – convenient for a quick status review, as well as reduced downtime.

Imperial connections (inch sizes) can be implemented in a trouble-free fashion with hybrid fittings.

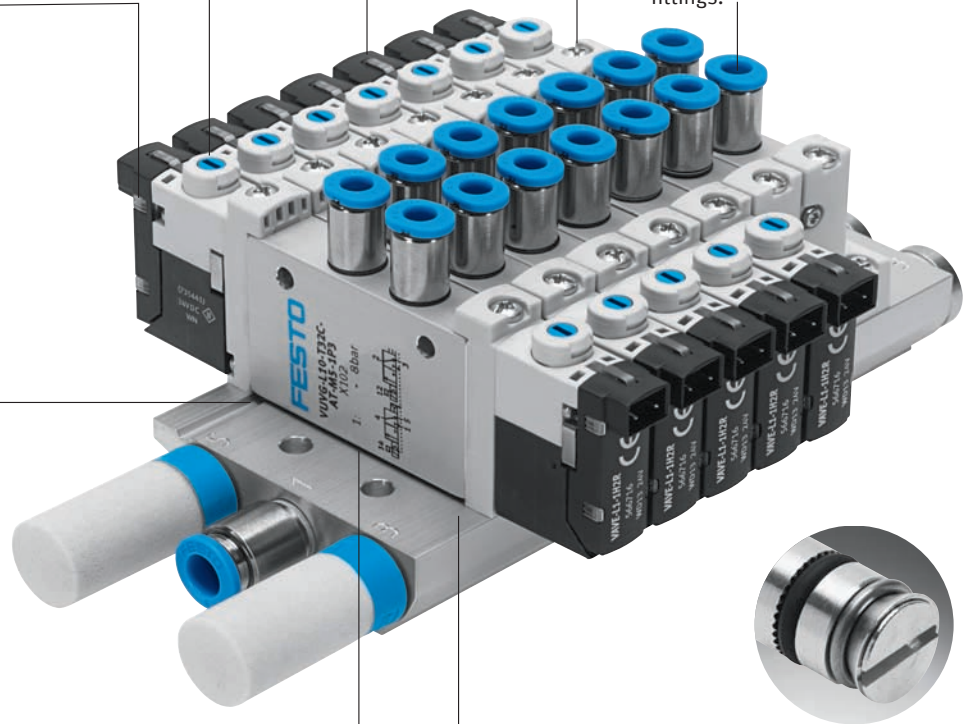
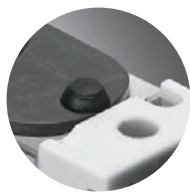

Direction indicator: detent for correct valve installation.

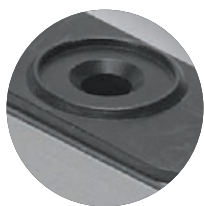

Positive-locking seal integrated into the valve.



Several pressure zones possible – quickly and easy with separators.

Make the most of the available installation space with a host of connection options and functions.



Highly flexible: individual valves can be assembled in series without an additional manifold strip thanks to axial mounting bores.



No additional components required to mount an individual valve onto a valve manifold.

All it needs is one click

The E-box (as pictured below) with patented, time tested contact system is ideal for OEMs and everyone who requires electrical variability at the valve. Replacing it takes just one click. **An astonishing range of variants can be fitted, regardless of the connection options used.** And the cable can be laid to the side or the top as desired. With IP40 and IP65 protection!

Advantages for purchasing and logistics
The valve housing remains the same. The only change is the E-box, which is snapped into place, making ordering and storage less complicated and less costly.

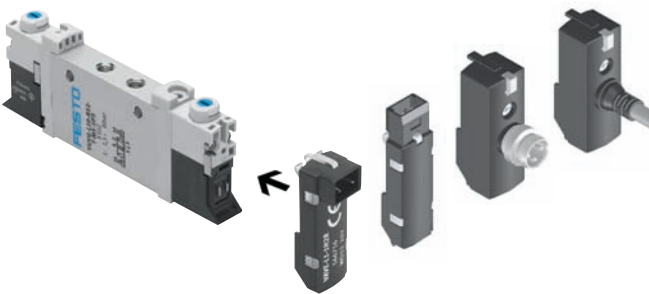

Technical data

- Valve functions: 5/2-way, 5/3-way, two 3/2-way
- Port sizes: M3, M5, M7 and G1/8
- Flow rates: 100, 220, 380, 750 l/min
- Temperature range: -5 to 60 °C
- Reversible piston spool valves
- Non-overlapping
- Operating pressure: 1.5 to 8 bar (-0.9 to 10 bar with external pilot air)
- Voltage variants: 5, 12 and 24 V DC
- Sturdy, light aluminium housing
- Valve sizes: 10 and 14 mm
- Protection: IP 40/IP 65
- Manual override: non-detenting/detenting
- Working ports: QS 3, 4, 6, 8
- Power consumption reduced by 0.35 W with holding current reduction circuit
- Wide range of electrical connection
- Integrated LED indicator

Ordering couldn't be simpler

Extremely easy! Quickly configured and easily ordered – thanks to the simple order code.

A list of available valve types can be found on at www.festo.com/en/vuvg

Or ask your Festo sales engineer.

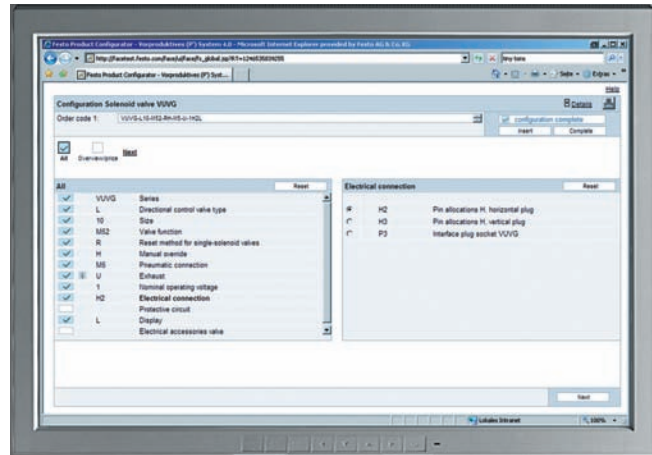

Clearly spelled out: the order code

VUVG solenoid valve, M5 in-line valve and in-line valve for manifold FESTO

Order code

VUVG	-	-	10	-	-	-	-	-	-	1	L	-
------	---	---	----	---	---	---	---	---	---	---	---	---

Valve design

In-line valve	L
In-line valve for manifold	S

Width

10mm	10
------	----

Valve functions

	T32C
	T32U
	T32H
	M52
	B52
	P53C
	P53U
	P53E

Reset method

Pneumatic spring for T32	A
Pneu./mech. spring for M52	R

Pilot air supply

internal	-
----------	---

Manual override

Pushing (non-detenting)	H
Concealed	S
Pushing, detenting with tool	T

Connecting cable

W1...W4	Not encased
---------	-------------

Display

L	LED
---	-----

Protective circuit

-	Without holding current reduction
R	With holding current reduction

Electrical sub-base

H2	Pin allocations H, horizontal plug
H3	Pin allocations H, vertical plug
P3	Without electrical sub-base

Operating voltage

1	24 V DC
---	---------

Venting for VUVG-L

-	QS when QS ²⁾
U	Silencer
QN	M5

Pneumatic connection

M5	Thread M5
Q3	Plug connector 3 mm/M5
Q4	Plug connector 4 mm/M5

VUVG: wide-ranging use

Unlimited use in all industries!

The VUVG is suitable for all industries where cost-sensitive, compact, solutions with high flow rates and versatile connections are required, such as, for example, compact handling applications.

For example

- Electronics industry
- Solar industry
- Textiles industry
- Packaging industry
- Printing industry
- Injection moulding
- ... and many others



Find out how you can benefit from the VUVG

Try something new and different – complete this simple checklist and benefit from the great advantages of the VUVG!

Design Are you looking for more compact and faster systems?

- Our customers want smaller valves and drives
- New solutions?
Sounds interesting. 10 bar technology and vacuum using standard valves could really expand the range of possible applications.
- Lighter?
Always a positive point. Aluminium instead of zinc saves lots of weight.
- Faster?
Of course! High flow rates and short cycle times are ideal for my applications.

Supply chain Are you saving in the right place?

- Extremely long service life?
Great – I can get increased output, less downtime and peace of mind.
- A single click? If that's how easy it is to replace the electrical connections with the E-box, then that would not only save me time, it would also reduce the range of part numbers and inventory.
- More flow with the same size? I could do with smaller valves, if it means I will save time and space!
- Just one single valve for a large range of applications?
I don't need two valve sizes in order to run my applications in an optimised fashion.

Installation and commissioning Is it quick and reliable?

- Reliable, error-free, simple installation?
Great! Retained mounting screws and positive-locking seals with specified installation direction would make a difference, especially under difficult conditions, e.g. overhead mounting
- Additional mounting components or adapters?
Not needed at all with the VUVG!
- Easy to install?
It's not a promise, it's a fact! Thanks to the manual override, as well as pre-assembled cables and electrical connectors, e.g. M8. And individual valves are extremely easy to connect in series without a manifold block.

Operation Do you take advantage of maximum reliability with more functions?

- Short cycle times and drives with a compact layout?
It's all possible – as is vacuum or 10 bar technology!
- IP65?
No problem! Always used in harsh or moist environments
- Wear and pressure loss?
Significantly reduced. And non-overlapping too, even during dual-pressure operation.

Convinced? We look forward to hearing from you!
Please contact your Festo sales engineer