

Cantilever axes ELCC

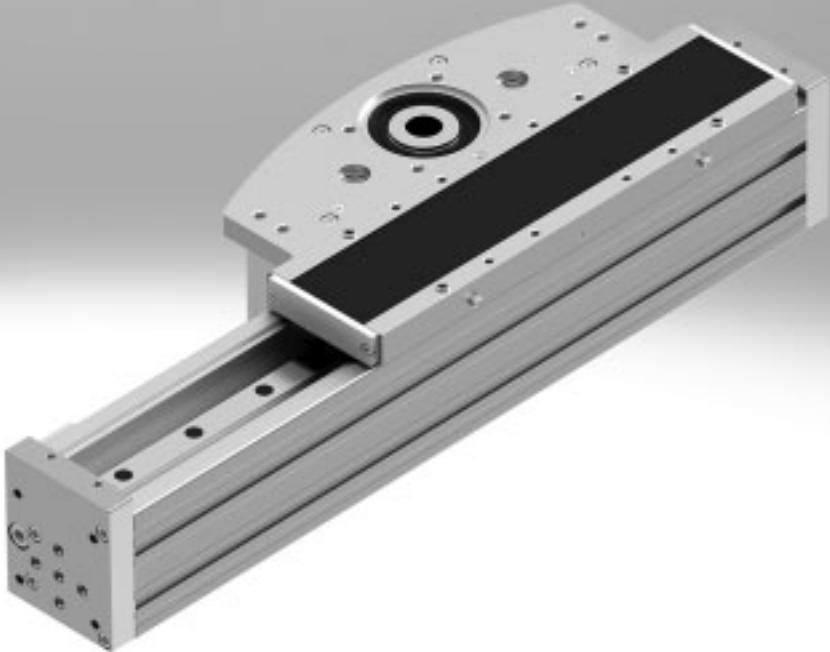

Cantilever axes ELCC

Key features

At a glance

- High rigidity thanks to innovative design principle
- Very small moving mass
- Able to move high loads of up to 100 kg vertically
- Optionally with NSF-H1 lubricant for the food zone
- Toothed belt material can be selected from:
 - Chloroprene rubber for long service life
 - Uncoated PU for the food zone
 - Coated PU with steel reinforcements for long service life and resistance to cooling lubricants

The technology in detail

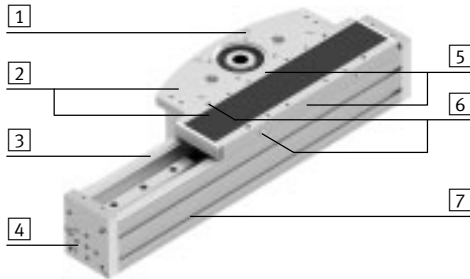

- 1** Interface for motor attachment
- 2** Drive head
- 3** Cantilever profile
- 4** Front end
- 5** Connection for clamping unit or sealing ring
- 6** Lubrication hole
- 7** Mounting slot for accessories

Protection against particles



- Stainless steel cover strip provides basic protection for the guide

Motor attachment (can also be mounted underneath)

Axial



With angled gear unit



Additional slide



- Rigidity and load-bearing capacity are increased by having twice as many roller carriages and a greater distance between bearings

Clamping unit

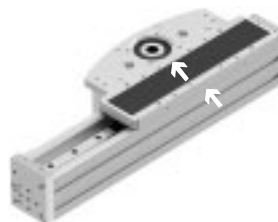

- For holding loads securely (frictional locking)
- Integrated into the axis so it does not protrude
- Acts directly on the guide (in any position)
- Can also be used for emergency braking operations

Displacement encoder system



- The position is detected incrementally and without contact
- To improve absolute accuracy
- 2-channel solutions are possible together with the motor encoder and a safety relay unit
- For sizes 60/70, the displacement encoder unit is mounted externally; for sizes 90/110, it is concealed under the toothed belt

Sealing air connection

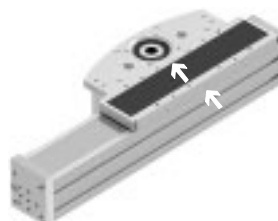

- Application of vacuum minimises the dispersal of abraded particles into the environment
- Application of gauge pressure prevents dirt from getting into the axis
- Cannot be used in combination with the clamping unit

Cantilever axes ELCC

Key features

Complete system comprising toothed belt axis, motor, motor controller and motor mounting kit
Cantilever axis



Motor



Servo motor EMME-AS



Note

A range of specially adapted complete solutions is available for the cantilever axis ELCC and the motors.

Motor controller



Servo motor controller CMMP-AS

Motor mounting kit

Axial kit



Kit comprising:

- Motor flange
- Coupling housing
- Coupling
- Screws

Cantilever axes ELCC

Type codes

		ELCC	-	TB	-	KF	-	70	-	800	-	20H	-	
Type														
ELCC	Cantilever axis													
Drive function														
TB	Toothed belt													
Guide														
KF	Recirculating ball bearing guide													
Size														
Stroke [mm]														
Stroke reserve														
Additional slide														
-	None													
ZL	Slide on left													
ZR	Slide on right													
ZLC	Slide on left, with clamping unit													
ZRC	Slide on right, with clamping unit													

Cantilever axes ELCC

Type codes

→	-	P0	-		-	CR	-		-		-	
Protection against particles												
P0	Without strip cover											
P9	With strip cover											
Additional features												
-	None											
F1	Suitable for use in the food industry as per supplementary material information											
Toothed belt material												
CR	Chloroprene rubber											
PU1	Uncoated PU for the food zone											
PU2	Coated PU											
Displacement encoder, incremental												
-	None											
M1	Resolution 2.5 µm											
Clamping unit												
-	None											
C	Attached											
Operating instructions												
-	Standard											
DN	Express waiver – no operating instructions to be included (already available)											

Cantilever axes ELCC

Peripherals overview

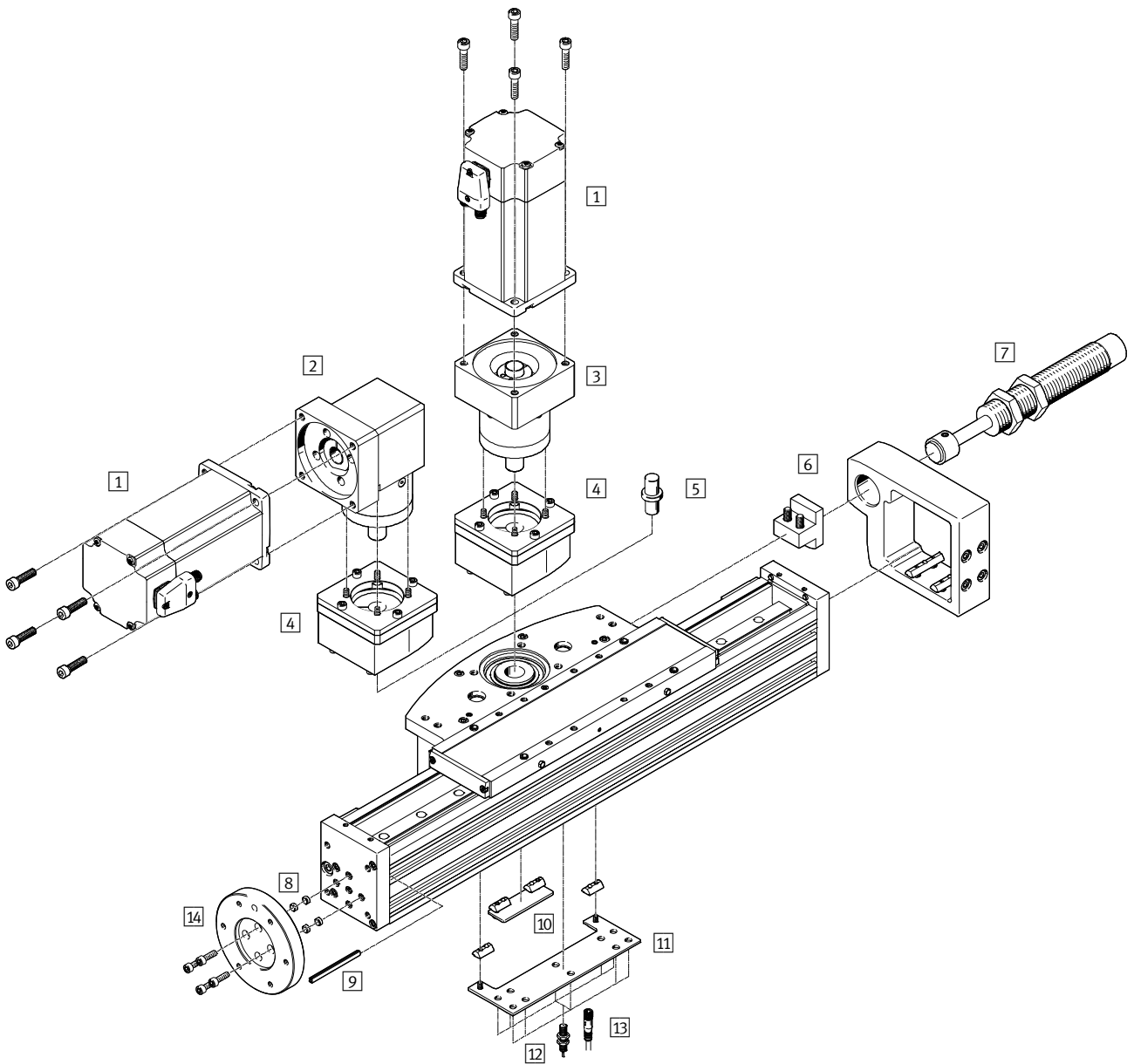

Cantilever axes ELCC

Peripherals overview



Accessories			
	Type	Description	→ Page/Internet
1	Motor EMME	Motors specially matched to the axis, with or without gear unit, with or without brake	25
2	Gear unit, angled EMGA-...-A	With gear ratio $i = 3$ and $i = 5$	25
3	Gear unit, straight EMGA-...-A	With gear ratio $i = 3$ and $i = 5$	25
4	Axial kit EAMM	For axial motor mounting (comprises: coupling, coupling housing and motor flange)	25
5	Drive shaft EAMB	<ul style="list-style-type: none"> • Can, if required, be used as an alternative interface • No drive shaft is required for the axis/motor combinations → page 25 	31
6	Shock absorber retainer DAYP-E21	For mounting a shock absorber on the axis	29
7	Shock absorber YSR	<ul style="list-style-type: none"> • Protects the axis from damage in the event of power failure or unintended lowering • Max. impact energy must be observed 	31
8	Centring pin/sleeve ZBS, ZBH	<ul style="list-style-type: none"> • For centring attachments on the front end • For mounting the drive head 	31
9	Slot cover ABP	For protection against contamination	31
10	Switch lug DASI-E21-SL	For sensing the slide position	28
11	Sensor bracket DASI-E21-SR	For mounting the inductive proximity sensors (round design) on the axis	28
12	Proximity sensor, M8 SIEN-M8	Inductive proximity sensor, round design	32
13	Connecting cable NEBU	For proximity sensor SIEN-M8	32
14	Adapter kit DHAA-R	For interface to ISO 9409-1:2004	30
–	Adapter kit DHAA	<ul style="list-style-type: none"> • Drive/drive connections • Drive/gripper connections 	dhaa
–	Slot nut NST	For mounting attachments	31
–	Connecting shaft KSK	<ul style="list-style-type: none"> • For torsion-resistant transmission of torques • For slip-free transmission of feed rates • To operate two cantilever axes in parallel using one motor 	31

Cantilever axes ELCC

Technical data

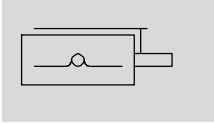
Function



-  - Size
60 ... 110
-  - Stroke length
50 ... 2000 mm

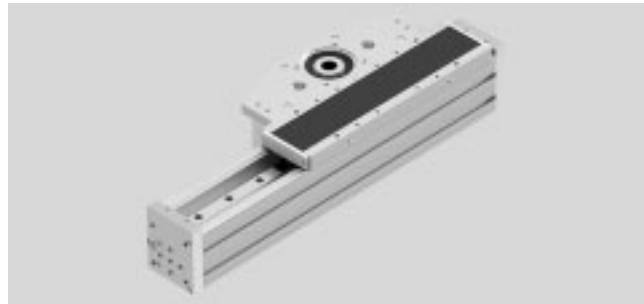

General technical data					
Size		60	70	90	110
Design		Electromechanical cantilever axis			
Guide		Recirculating ball bearing guide			
Mounting position		Any			
Working stroke ¹⁾	[mm]	50 ... 1300	50 ... 1500	50 ... 2000	50 ... 2000
Max. feed force F_x	[N]	300	600	1200	2500
Max. no-load torque ²⁾	[Nm]	0.6	1.2	2.5	4
Max. driving torque	[Nm]	4.6	9.2	30.6	85.9
Max. speed	[m/s]	5			
Max. acceleration	[m/s ²]	50			30
Repetition accuracy	[mm]	±0.05			

- 1) Longer strokes on request
2) At 0.2 m/s

Operating and environmental conditions		
Ambient temperature ¹⁾	[°C]	-10 ... +60
Degree of protection		IP20
Duty cycle	[%]	100

- 1) Note operating range of proximity sensors

Weight [g]					
Size		60	70	90	110
Total mass at 0 mm stroke ¹⁾					
ELCC-...		2510	4750	9300	17000
ELCC-...-ZL/ZR		805	2010	2997	4777
ELCC-...-C		-	278	416	772
Moving mass at 0 mm stroke					
ELCC-...		1636	3210	5487	10017
ELCC-...-ZL/ZR		1102	2306	3721	6936
Additional weight per 10 mm stroke					
ELCC-...		38	63	97	148

- 1) Total mass = stationary mass + moving mass

Cantilever axes ELCC

Technical data

Toothed belt					
Size		60	70	90	110
Pitch	[mm]	3	3	5	8
Expansion ¹⁾					
ELCC-...-CR	[%]	0.17	0.22	0.14	0.17
ELCC-...-PU1/PU2	[%]	0.07	0.08	0.06	-
Width	[mm]	30	50	75	100
Effective diameter	[mm]	30.558	30.558	50.93	68.755
Feed constant	[mm/U]	96	96	160	216

1) At max. feed force

Mass moment of inertia					
Size		60	70	90	110
J_0	[kg mm ²]	594	1063	5518	15710
J_S per metre stroke	[kg mm ² /m]	887	1471	6290	17491
J_L per kg payload	[kg mm ² /kg]	233	233	648	1182

 The mass moment of inertia J_A of the entire axis is calculated as follows:

Basic variant

$$J_A = J_0 + J_S \times \text{working stroke [m]} + J_L \times m_{\text{payload [kg]}}$$

With gear unit

$$J_A = J_G + \frac{J_0 + J_S \times \text{working stroke [m]} + J_L \times m_{\text{payload [kg]}}}{i^2}$$

 J_G = Mass moment of inertia, gear unit

Materials

Sectional view

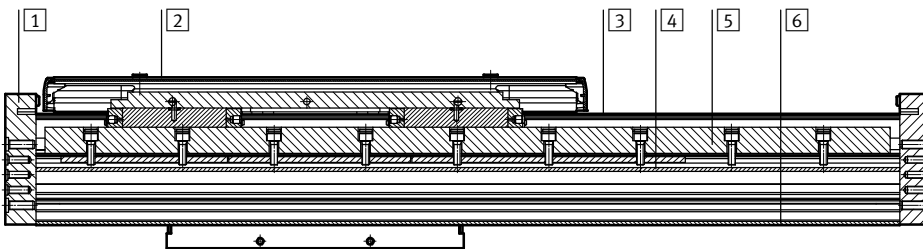

Axis Size		60	70	90	110
1	End cap	Anodised wrought aluminium alloy			
2	Drive head	Anodised wrought aluminium alloy			
3	Cover strip	Stainless steel strip, non-corroding			
4	Toothed belt	ELCC-...-CR: Polychloroprene with glass cord and nylon coating ELCC-...-PU1: Polyurethane with steel cord (for food zone) ELCC-...-PU2: Polyurethane with steel cord and textile coating			
5	Guide rail	Rolled steel, corrotect coated			
6	Profile	Anodised wrought aluminium alloy			
-	Slide	Anodised cast aluminium			
Note on materials		RoHS-compliant			
		Contains paint-wetting impairment substances			

corrotect® is a registered trademark of its respective trademark holder in certain countries.

Cantilever axes ELCC

Technical data

Technical data – Displacement encoder system					
Size		60	70	90	110
Resolution	[µm]	2.5			
Max. travel speed with displacement encoder system	[m/s]	4			
Encoder signal		5 V TTL; A/A, B/B; reference signal (N/N) cyclically every 5 mm (zero pulse)			
Signal output		Line driver, alternating, resistant to sustained short circuit			
Electrical connection		8-pin plug, round design, M12			
Cable length	[mm]	160	160	45	25

Operating and environmental conditions – Displacement encoder system	
Ambient temperature	[°C] -10 ... +70
Degree of protection	IP64
CE marking (see declaration of conformity)	To EU EMC Directive ¹⁾

- 1) For information about the applicability of the component see the manufacturer's EC declaration of conformity at: www.festo.com/sp → Certificates.
If the component is subject to restrictions on usage in residential, office or commercial environments or small businesses, further measures to reduce the emitted interference may be necessary.

Technical data – Clamping unit				
Size		70	90	110
Pneumatic connection		M5		
Clamping type		Clamping via spring force, released via compressed air		
Static holding force	[N]	450	550	850
Max. number of emergency braking operations ¹⁾ at reference energy	[J]	1000 30	1000 30	1000 30
Number of clamping operations under nominal load	[million switching cycles]	0.05	0.05	0.05

- 1) Emergency braking refers to braking the payload if the drive axis loses power.

Operating and environmental conditions – Clamping unit	
Operating medium	Compressed air to ISO 8573-1:2010 [7:4:4]
Operating pressure	[bar] 4 ... 6.5
Ambient temperature	[°C] -10 ... +60

Cantilever axes ELCC

Technical data

Characteristic load values of the axis in slide operation



In slide operation, the profile is fixed and mounted in such a way that it does not sag. The indicated forces and torques refer to the centre of the guide. The point of application of force is the point where the centre of the guide and the longitudinal centre of the slide intersect. These values must not be exceeded during dynamic operation. Special attention must be paid to the cushioning phase.

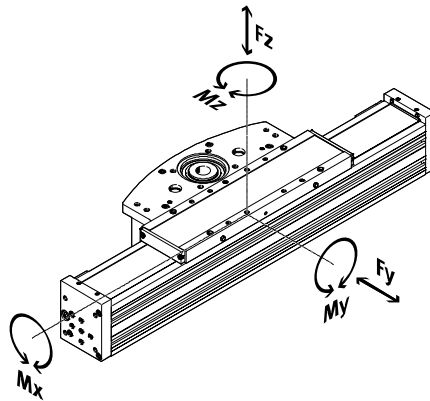

Distance from the slide surface to the centre of the guide

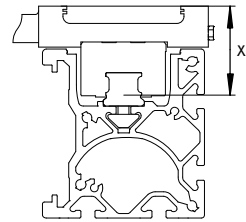

Distance from the slide surface to the centre of the guide				
Size	60	70	90	110
Dimension x [mm]	29.9	39.1	43.8	54.0

Max. permissible forces and torques for a service life of 5000 km in slide operation				
Size	60	70	90	110
F _{y,max.} [N]	4200	9600	13900	20600
F _{z,max.} [N]	4100	9400	13500	20000
M _{x,max.} [Nm]	35	105	165	315
M _{y,max.} [Nm]	290	825	1300	2365
M _{z,max.} [Nm]	285	795	1230	2285

Note

For a guide system to have a service life of 5000 km, the load comparison factor must have a value of $f_v < 1$, based on the maximum permissible forces and torques for a service life of 5000 km.

If the axis is subjected to two or more of the indicated forces and torques simultaneously, the following equation must be satisfied in addition to the indicated maximum loads:

Calculating the load comparison factor:

$$f_{vG} = \frac{|F_{y,dyn}|}{F_{y,max}} + \frac{|F_{z,dyn}|}{F_{z,max}} + \frac{|M_{x,dyn}|}{M_{x,max}} + \frac{|M_{y,dyn}|}{M_{y,max}} + \frac{|M_{z,dyn}|}{M_{z,max}}$$

Cantilever axes ELCC

Technical data

Characteristic load values of the axis in cantilever operation



The axis is subjected to a higher load in cantilever operation because of the deflection. The torques are thus reduced in comparison to slide operation.

The indicated forces and torques refer to the centre of the guide. The point of application of force is the point where the centre of the guide and the longitudinal centre of the slide intersect. These values must not be exceeded during dynamic operation. Special attention must be paid to the cushioning phase.

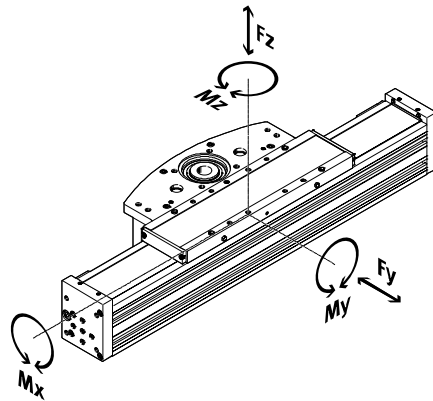

Distance from the slide surface to the centre of the guide

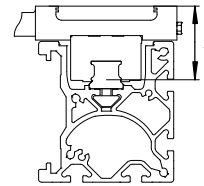

Axis positions

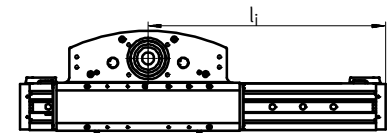

Distance from the slide surface to the centre of the guide				
Size	60	70	90	110
Dimension x [mm]	29.9	39.1	43.8	54.0

Max. permissible forces and torques for a service life of 5000 km in cantilever operation				
Size	60	70	90	110
Fyperm. [N]	4200	9600	13900	20600
Fzperm. [N]	4100	9400	13500	20000
Mxperm. [Nm]	20	50	75	180
Myperm. [Nm]	110	240	350	885
Mzperm. [Nm]	90	190	295	615

Step 1:

Calculating the load comparison factor f_{vi} for the different axis positions l_i

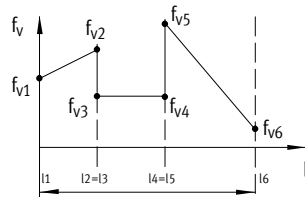

$$f_{vi} = \frac{|F_{y,dyn}|}{F_{y,perm.}} + \frac{|F_{z,dyn}|}{F_{z,perm.}} + \frac{|M_{x,dyn}|}{M_{x,perm.}} + \frac{|M_{y,dyn}|}{M_{y,perm.}} + \frac{|M_{z,dyn}|}{M_{z,perm.}}$$

f_{vi} : $f_{v1}, f_{v2}, f_{v3}, f_{v4}, f_{v5}, f_{v6}, \dots$

If all $f_{vi} \leq 1$, then for simplicity the following can be assumed: total load comparison factor f_{vG} corresponds to the largest f_{vi} ; steps 2-3 can be omitted.

If one $f_{vi} > 1$, the exact total load comparison factor f_{vG} should be calculated using steps 2 and 3.

Step 2:

Calculating the substitute load comparison factors for the different partial strokes f_{vEi}

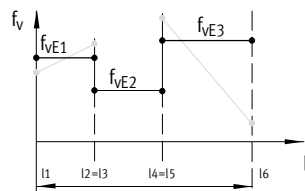

$$f_{vEi} = \sqrt[3]{\frac{(f_{vi} + f_{vi+1}) \times (f_{vi}^2 + f_{vi+1}^2)}{4}}$$

f_{vEi} : $f_{vE1}, f_{vE2}, f_{vE3}, \dots$

f_{vE1} : Substitute load comparison factor for partial stroke 1

l_1 to l_2 : Partial stroke 1

Step 3:

Calculating the load comparison factor f_{vG} for the total stroke

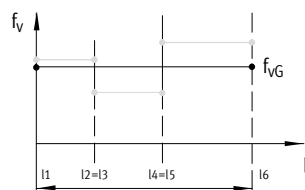

$$f_{vG} = \sqrt[3]{\sum \frac{f_{vEi}^3 \times (l_{i+1} - l_i)}{l_{ges}}}$$

f_{vG} : Load comparison factor for total stroke

Step 4:

Calculating the service life

$$L = \frac{5000km}{f_{vG}^3}$$

Cantilever axes ELCC

Technical data

Calculating the service life

The service life of the guide depends on the load. To be able to make a statement about the service life of the guide, the graph below plots the total load comparison factor f_{VG} against the service life.

These values are only theoretical. You must consult your local Festo contact for a total load comparison factor f_{VG} greater than 1.5.

Total load comparison factor f_{VG} as a function of service life

Example:

A user wants to move an X kg load. Using the formula (→ page 11/12) gives a value of 1.5 for the total load comparison factor f_{VG} . According to the graph, the guide has a service life of approx. 1500 km.

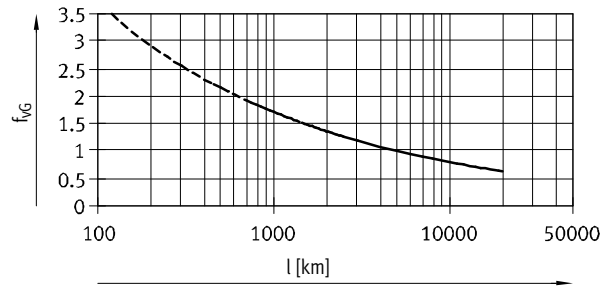

Note

PositioningDrives
engineering software
www.festo.com

The software can be used to calculate a guide workload for a service life of 5000 km.

Comparison of the characteristic load values for 5000 km with dynamic forces and torques of recirculating ball bearing guides

The characteristic load values of bearing guides are standardised to ISO and JIS using dynamic and static forces and torques. These forces and torques are based on an expected guide system service life of 100 km to ISO or 50 km to JIS. As the characteristic load values are dependent on the service life, the maximum permissible forces and torques for a 5000 km service life cannot be compared with the dynamic forces and torques of bearing guides to ISO/JIS.

To make it easier to compare the guide capacity of cantilever axes ELCC with bearing guides, the table below lists the theoretically permissible forces and torques for a calculated service life of 100 km. This corresponds to the dynamic forces and torques to ISO.

These 100 km values have been calculated mathematically and are only to be used for comparing with dynamic forces and torques to ISO. The drives must not be loaded with these characteristic values as this could damage the axes.

Max. permissible forces and torques for a theoretical service life of 100 km (from a guide perspective only)					
Size		60	70	90	110
$F_{y_{max}}$	[N]	17101	39712	57255	84489
$F_{z_{max}}$	[N]	16410	37901	54354	80725
$M_{x_{max}}$	[Nm]	138	401	643	1221
$M_{y_{max}}$	[Nm]	1126	3138	4838	8982
$M_{z_{max}}$	[Nm]	1086	2954	4548	8488

Cantilever axes ELCC

Technical data

Speed v as a function of rotational speed n

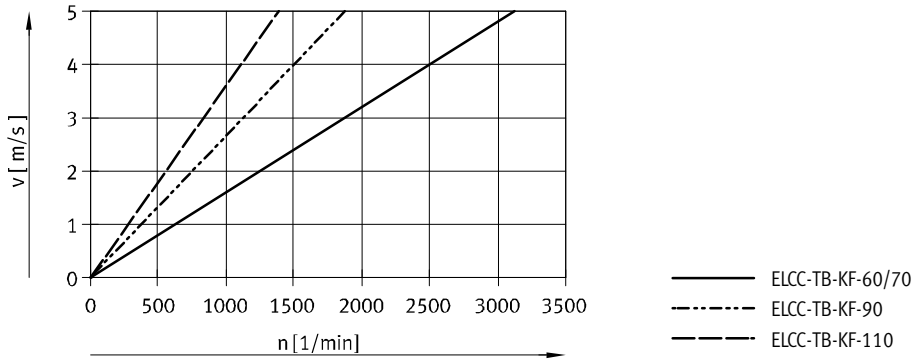

Theoretical feed force F as a function of input torque M

Size 60/70

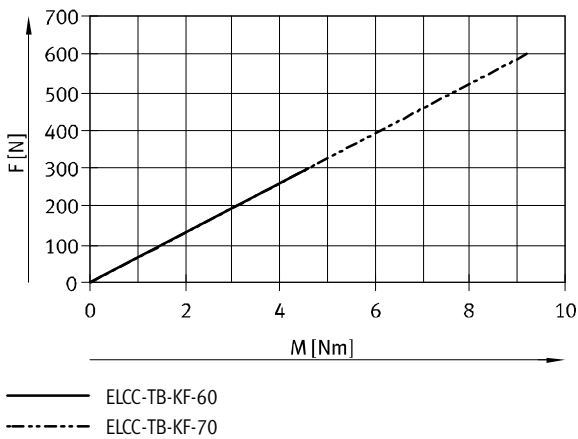

Size 90/110

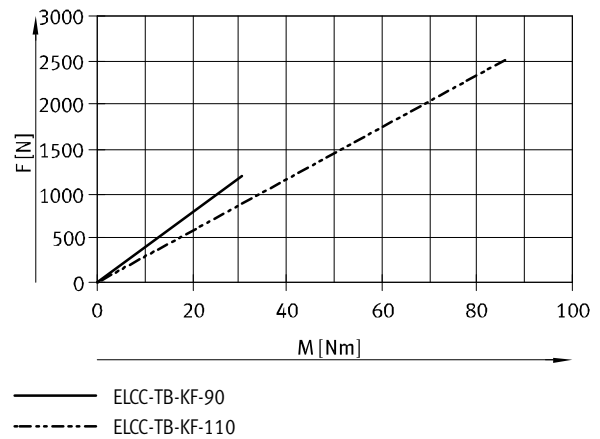

Second moment of area

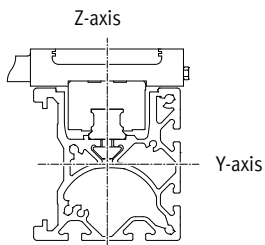

Size		60	70	90	110
ly	[mm ⁴]	240.60x10 ³	959.74x10 ³	2.67x10 ⁶	6.83x10 ⁶
lz	[mm ⁴]	304.21x10 ³	928.74x10 ³	2.05x10 ⁶	4.93x10 ⁶

Cantilever axes ELCC

Technical data

Stroke reserve

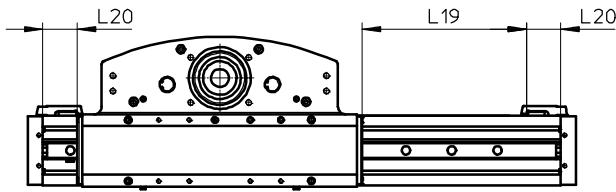

L19 = Nominal stroke
L20 = Stroke reserve

- The stroke reserve is a safety distance which is not used in normal operation
- The sum of the nominal stroke and 2x stroke reserve must not exceed the maximum working stroke
- The stroke reserve length can be freely selected
- The stroke reserve is defined via the "stroke reserve" characteristic in the modular product system.

Example:

Type ELCC-TB-KF-70-500-20H-...
 Nominal stroke = 500 mm
 2x 20 mm stroke reserve = 40 mm
 Working stroke = 540 mm
 (540 mm = 500 mm + 2x 20 mm)

Working stroke reduction

For axis ELCC with additional slide ZL/ZR

For a cantilever axis with additional slide, the working stroke is reduced by the length of the additional slide and the distance between the two slides

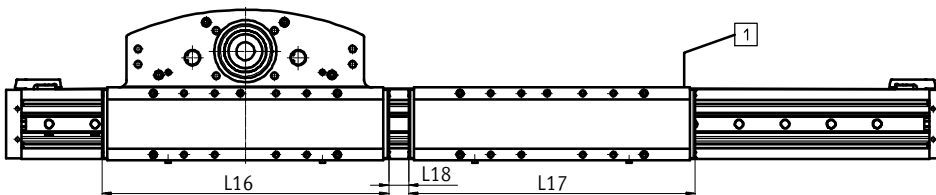

- L16 = Slide length
- L17 = Additional slide length
- L18 = Distance between the two slides
- 1 Additional slide

Example:

Type ELCC-TB-KF-70-1500-...-ZR
 Working stroke without additional slide = 1500 mm
 L18 = 50 mm
 L17 = 356 mm
 Working stroke with additional slide = 1094 mm
 (1500 mm – 50 mm – 356 mm)

Dimensions – Additional slide

Size	60	70	90	110
Length L17 [mm]	280	356	374	458
Min. distance between the slides L18				
ELCC-...-P0 [mm]	≥ 5	≥ 5	≥ 5	≥ 5
ELCC-...-P9 [mm]	≥ 50	≥ 50	≥ 50	≥ 50

Cantilever axes ELCC

Technical data

Deflection f as a function of the cantilever extension A and the payload m

Interface for horizontal drive head 1

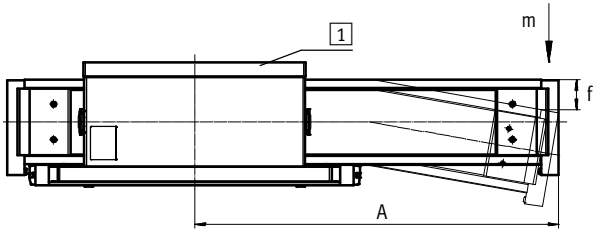

Interface for vertical drive head 1

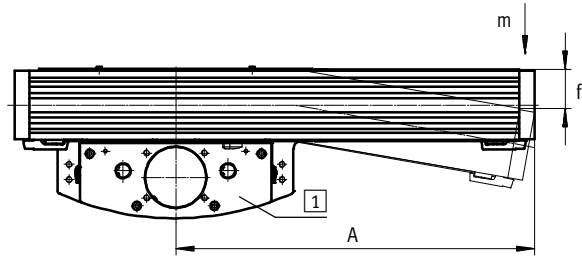

Size 60

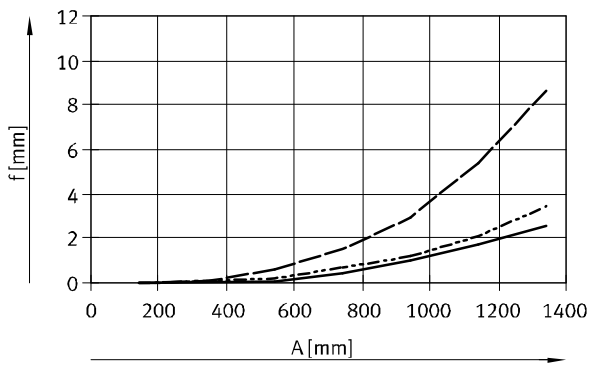

— $m = 0$ kg
 - - - $m = 5$ kg
 - · - $m = 10$ kg

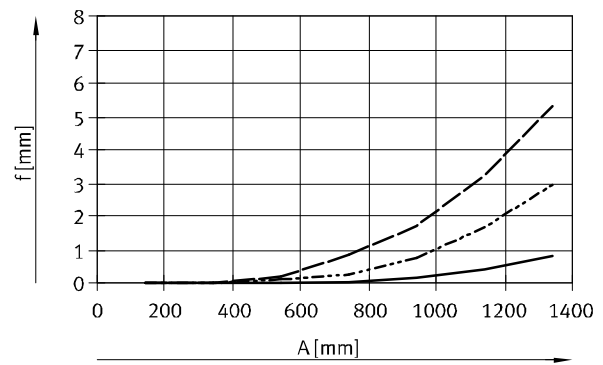

— $m = 0$ kg
 - - - $m = 5$ kg
 - · - $m = 10$ kg

Size 70

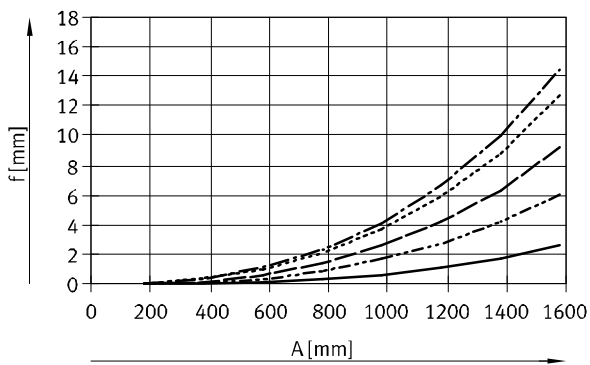

— $m = 0$ kg
 - - - $m = 10$ kg
 - · - $m = 20$ kg
 ····· $m = 30$ kg
 - - - - $m = 35$ kg

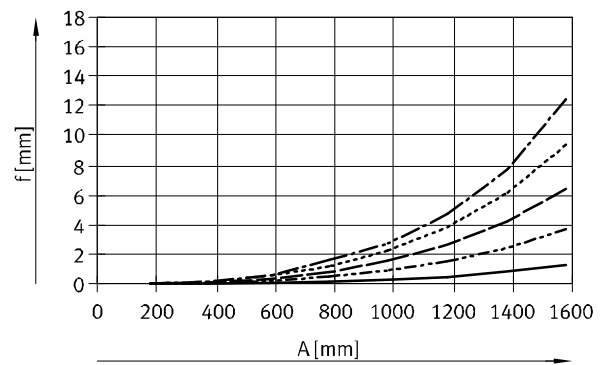

— $m = 0$ kg
 - - - $m = 10$ kg
 - · - $m = 20$ kg
 ····· $m = 30$ kg
 - - - - $m = 35$ kg

Cantilever axes ELCC

Technical data

Deflection f as a function of the cantilever extension A and the payload m

Interface for horizontal drive head 1

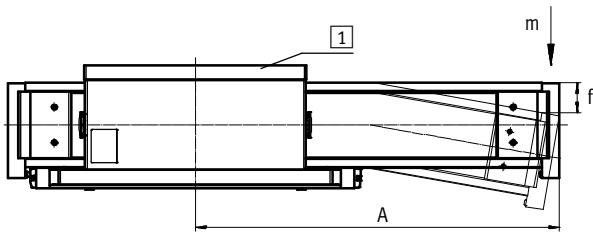

Interface for vertical drive head 1

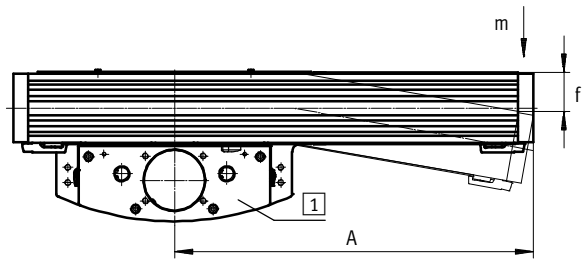

Size 90

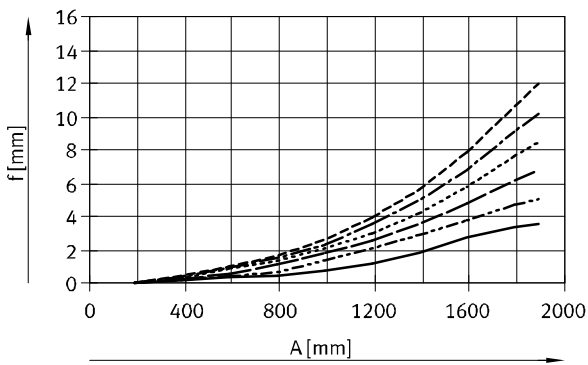

- $m = 0$ kg
- - - $m = 10$ kg
- · - $m = 20$ kg
- · · $m = 30$ kg
- · - $m = 40$ kg
- - - $m = 50$ kg

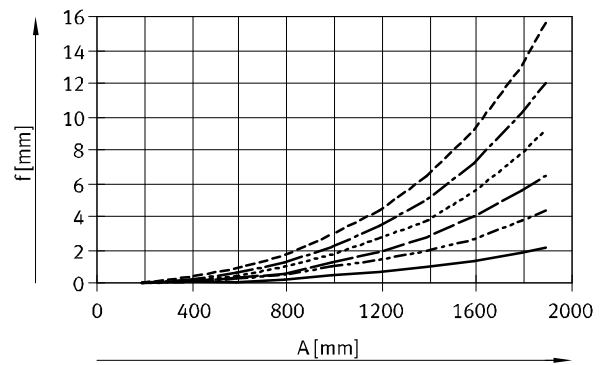

- $m = 0$ kg
- - - $m = 10$ kg
- · - $m = 20$ kg
- · · $m = 30$ kg
- · - $m = 40$ kg
- - - $m = 50$ kg

Size 110

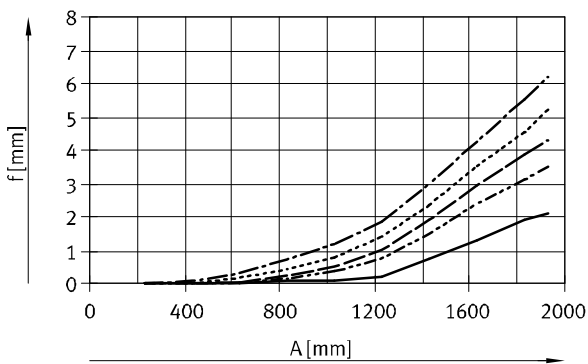

- $m = 0$ kg
- - - $m = 20$ kg
- · - $m = 30$ kg
- · · $m = 40$ kg
- · - $m = 50$ kg

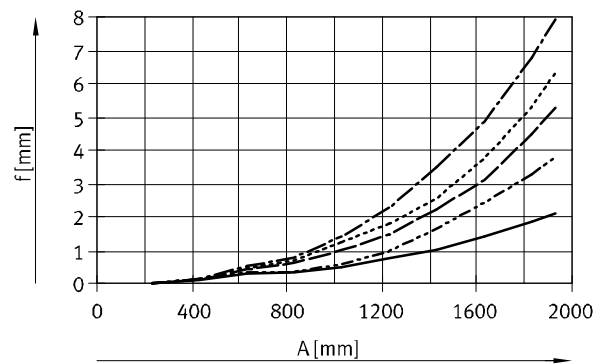

- $m = 0$ kg
- - - $m = 20$ kg
- · - $m = 30$ kg
- · · $m = 40$ kg
- · - $m = 50$ kg

Cantilever axes ELCC

Technical data

Dimensions

Download CAD data → www.festo.com

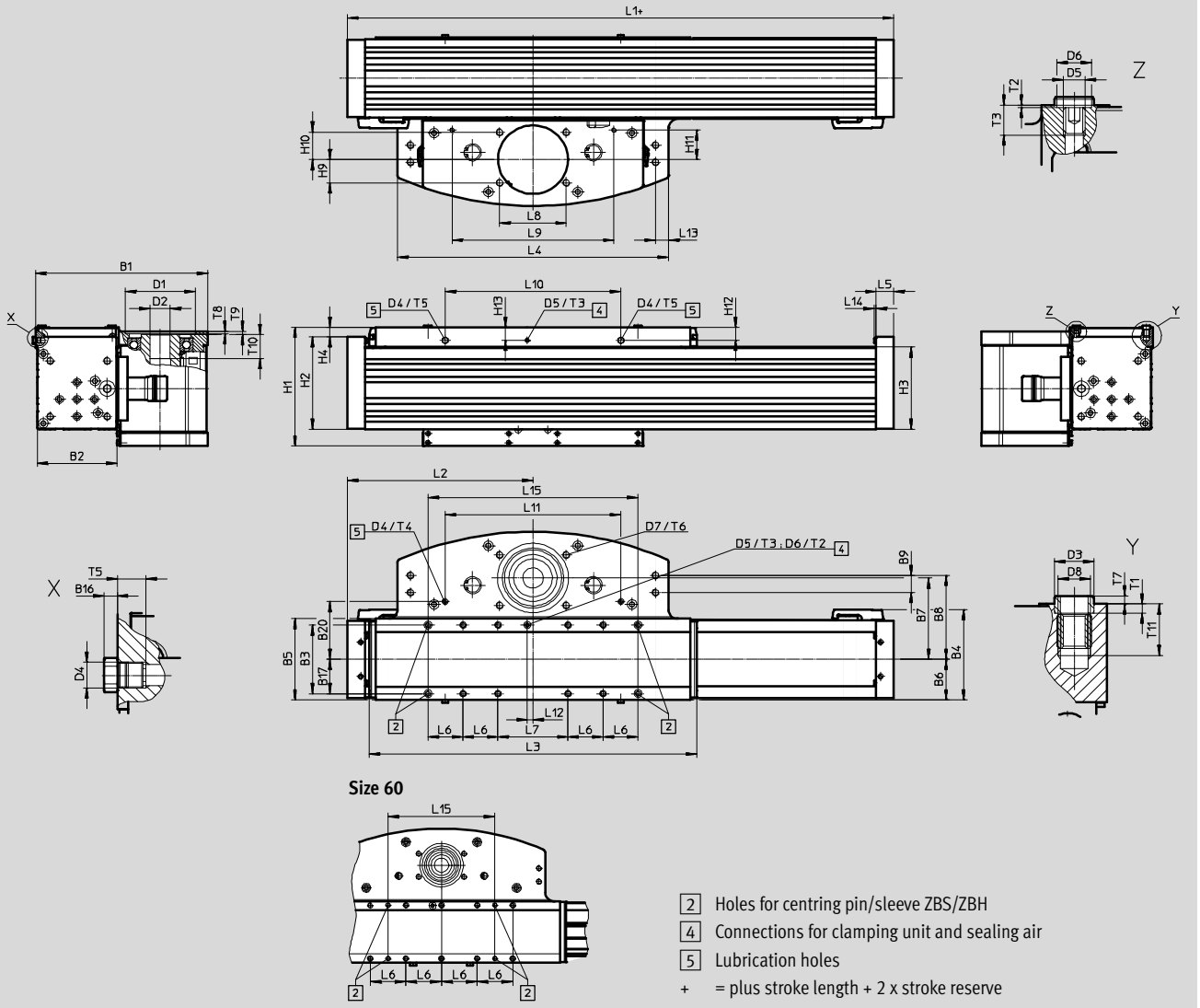

Size	B1	B2	B3	B4	B5	B6	B7	B8	B9	B16	B17
60	150.5	59.5	60	77.1	69	34.5	75	71.5	15	3	29.5
70	167.5	73	78	94.1	90	45	81.5	81.5	16	3	39
90	196.5	91	80	105.6	95	47.5	95	98	20	3	40
110	247.5	113	100	130.3	117	58.5	120	112	20	3	50

Size	B20	D1	D2	D3	D4	D5	D6	D7	D8	H1	H2
		∅	∅	∅			∅				
		H7	H7	H7			H7				
60	–	48	16	5	M6	M5	8	M6	M5	78.6	58
70	53	48	16	9	M6	M5	8	M6	M5	112	86
90	67.5	80	23	9	M6	M5	8	M8	M6	138.6	108
110	66	95	32	12	M6	M5	8	M8	M8	170.6	136.5

Cantilever axes ELCC

Technical data

Size	H3	H4	H9	H10	H11	H12	H13	L1	L2 min.	L3	L4
60	47	9	13	13	29	14.3	13	330	165	280	233
70	73	11	13	13	29	16	16	406	203	356	253
90	95	11	27	32	34.5	15	15	424	212	374	310
110	120	14.5	40	40	48.5	22	22	508	254	458	358

Size	L5	L6	L7	L8	L9	L10	L11	L12	L13	L14	L15
60	20	40	–	51	120	64	–	10	7	2	120
70	20	40	70	51	120	187	187	5.5	12	2	230
90	20	40	80	76	185	201	201	6.5	15	2	240
110	20	40	120	80	210	248	248	14.2	15	2	280

Size	T1	T2	T3	T4	T5	T6	T7	T8	T9	T10	T11
60	2.5	0.6	7	–	6.5	12	2.5	2.1	4	26	10
70	2.1	0.6	7	6.1	6.5	12	1.9	2.1	4	26	10
90	2.1	0.6	7	6.5	6.5	16	1.9	3.1	4	28	12
110	2.6	0.6	7	6.5	6.5	17	2.4	2.8	4	33	16.2

Cantilever axes ELCC

Technical data

Dimensions

Download CAD data → www.festo.com

Profile

Size 60

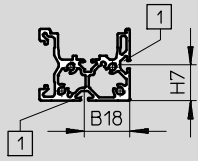

Size 70

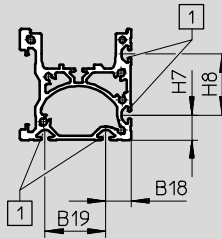

Size 90

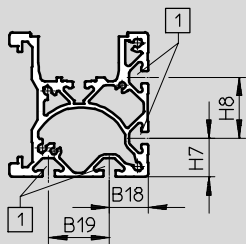

Size 110

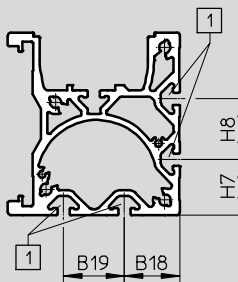

1 Mounting slot for slot nut

Size	H7	H8	B18	B19
60	23.5	-	29.75	-
70	16.5	40	16.5	40
90	25.5	40	25.5	40
110	36.5	40	36.5	40

Cantilever axes ELCC

Technical data

Dimensions

Download CAD data → www.festo.com

Interface on front end for mounting the payload

Size 60

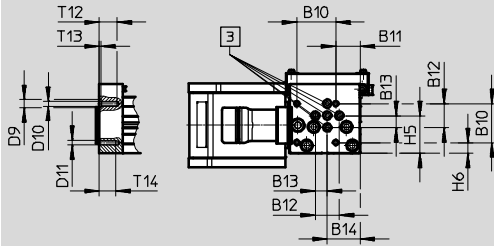

Size 70

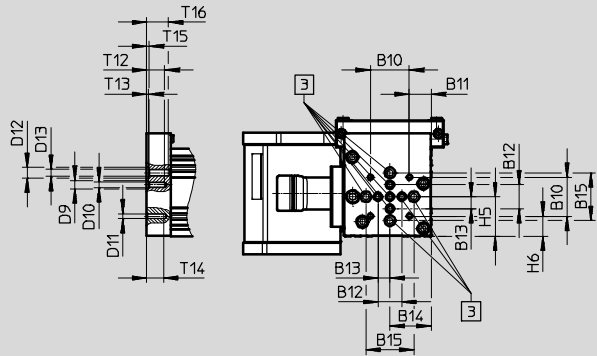

Size 90

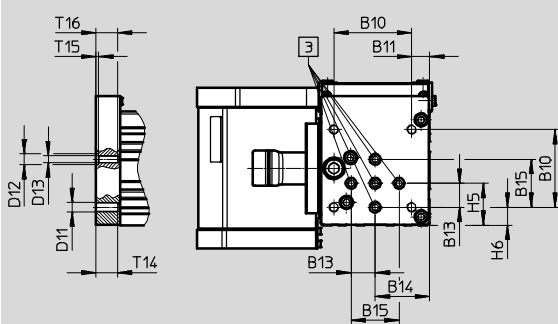

Size 110

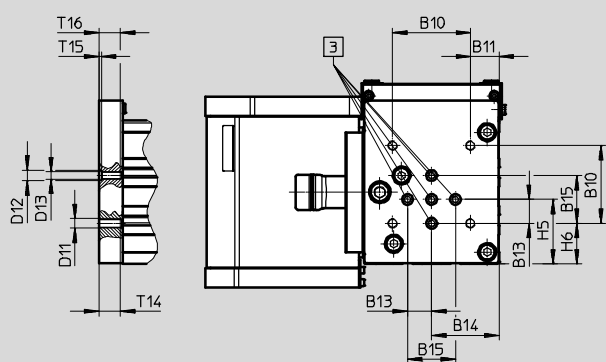

 Holes for adapter kit or centring sleeve ZBH

Size	B10	B11	B12	B13	B14	B15	D9 ∅ H7	D10	D11
60	32.5	20.5	20	10	27.5	–	7	M4	M4
70	32.5	18.3	20	10	34.5	40	7	M5	M4
90	65	15	–	20	45.5	40	–	–	M8
110	65	24	–	20	56.5	40	–	–	M8

Size	D12 ∅ H7	D13	H5	H6	T12	T13	T14	T15	T16
60	–	–	31.5	9	15	1.6	14	–	–
70	9	M6	33	16.75	15	1.6	14	2.1	18
90	9	M6	35	15	–	–	18	2.1	18
110	9	M6	54	34	–	–	18	2.1	18

Cantilever axes ELCC

Technical data

Dimensions

Download CAD data → www.festo.com

ELCC-TB-KF-60/70-...-M1 – With incremental displacement encoder system

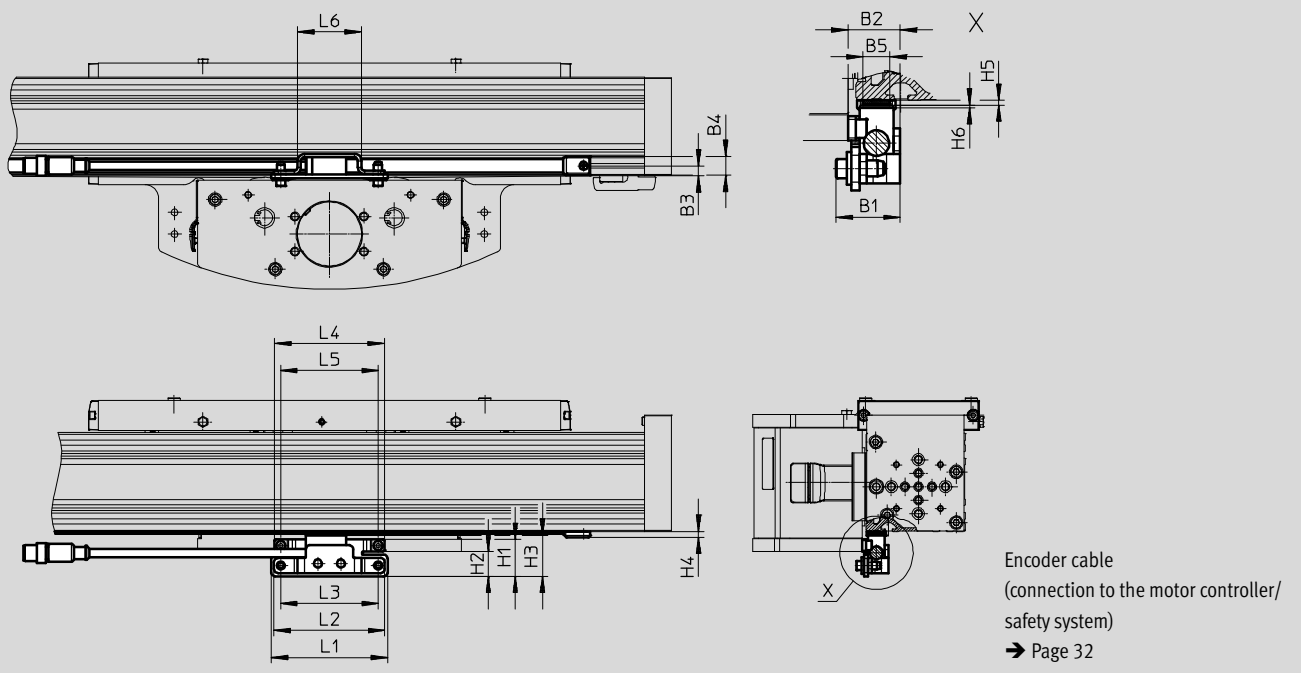

Size	B1	B2	B3	B4	B5	H1	H2	H3
60	32.6	26.8	15	14.1	10	30.5	19.1	30.5
70	23.6	19.3	7.5	14.1	10	27.3	18.3	30.5

Size	H4	H5	H6	L1	L2	L3	L4	L5	L6
60	4.5	1.8	1	86	82	72	81	72	47
70	4.5	1.8	1	86	82	72	81	72	47

ELCC-TB-KF-90/110-...-M1 – With incremental displacement encoder system



Size	L1
90	79
110	79

Cantilever axes ELCC

Technical data

Ordering data – Standard design

Key features:

- Stroke reserve: 0 mm
- Without strip cover
- Toothed belt material: Chloroprene rubber

Size	Stroke [mm]	Part no.	Type
60	200	8082386	ELCC-TB-KF-60-200-0H-P0-CR
	300	8082387	ELCC-TB-KF-60-300-0H-P0-CR
	500	8082388	ELCC-TB-KF-60-500-0H-P0-CR
	600	8082389	ELCC-TB-KF-60-600-0H-P0-CR
	800	8082390	ELCC-TB-KF-60-800-0H-P0-CR
	1000	8082391	ELCC-TB-KF-60-1000-0H-P0-CR
70	200	8082392	ELCC-TB-KF-70-200-0H-P0-CR
	300	8082393	ELCC-TB-KF-70-300-0H-P0-CR
	500	8082394	ELCC-TB-KF-70-500-0H-P0-CR
	600	8082395	ELCC-TB-KF-70-600-0H-P0-CR
	800	8082396	ELCC-TB-KF-70-800-0H-P0-CR
	1000	8082397	ELCC-TB-KF-70-1000-0H-P0-CR
	1200	8082398	ELCC-TB-KF-70-1200-0H-P0-CR
90	200	8082399	ELCC-TB-KF-90-200-0H-P0-CR
	300	8082400	ELCC-TB-KF-90-300-0H-P0-CR
	500	8082401	ELCC-TB-KF-90-500-0H-P0-CR
	600	8082402	ELCC-TB-KF-90-600-0H-P0-CR
	800	8082403	ELCC-TB-KF-90-800-0H-P0-CR
	1000	8082404	ELCC-TB-KF-90-1000-0H-P0-CR
	1200	8082405	ELCC-TB-KF-90-1200-0H-P0-CR
	1500	8082406	ELCC-TB-KF-90-1500-0H-P0-CR
	1700	8082407	ELCC-TB-KF-90-1700-0H-P0-CR
	2000	8082408	ELCC-TB-KF-90-2000-0H-P0-CR
110	200	8082409	ELCC-TB-KF-110-200-0H-P0-CR
	300	8082410	ELCC-TB-KF-110-300-0H-P0-CR
	500	8082411	ELCC-TB-KF-110-500-0H-P0-CR
	600	8082412	ELCC-TB-KF-110-600-0H-P0-CR
	800	8082413	ELCC-TB-KF-110-800-0H-P0-CR
	1000	8082414	ELCC-TB-KF-110-1000-0H-P0-CR
	1200	8082415	ELCC-TB-KF-110-1200-0H-P0-CR
	1500	8082416	ELCC-TB-KF-110-1500-0H-P0-CR
	1700	8082417	ELCC-TB-KF-110-1700-0H-P0-CR
	2000	8082418	ELCC-TB-KF-110-2000-0H-P0-CR

Cantilever axes ELCC

Ordering data – Modular product system

Orientation guide

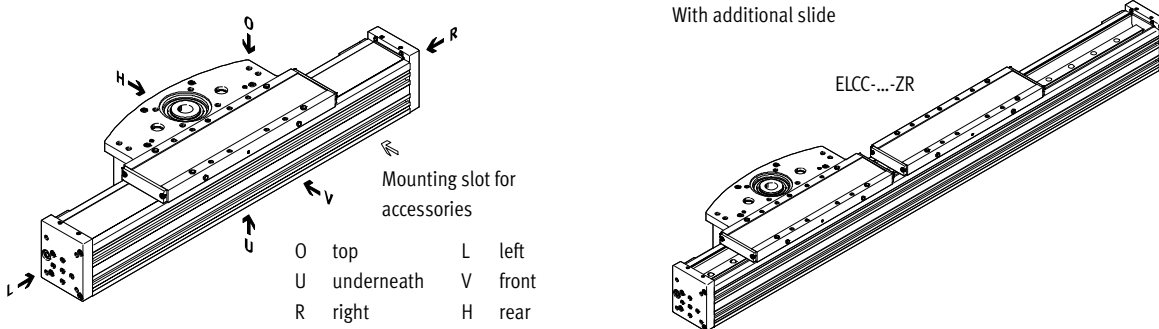

Ordering table			60	70	90	110	Conditions	Code	Entry code
M	Module no.		8060571	8060572	8060573	8060574			
	Function		Cantilever axis					ELCC	ELCC
	Drive system		Toothed belt					-TB	-TB
	Guide		Recirculating ball bearing guide					-KF	-KF
	Size		60	70	90	110		-...	
	Stroke	Standard [mm]	200, 300, 500, 600, 800, 1000	200, 300, 500, 600, 800, 1000, 1200	200, 300, 500, 600, 800, 1000, 1200, 1500, 1700, 2000	200, 300, 500, 600, 800, 1000, 1200, 1500, 1700, 2000		-...	
		Variable [mm]	50 ... 1300	50 ... 1500	50 ... 2000	50 ... 2000		-...	
	Stroke reserve	[mm]	0 ... 999 (0 = no stroke reserve)				1	-...H	
O	Additional slide		None						
			Slide on left				2	-ZL	
			Slide on right				2	-ZR	
			– Slide on left, with clamping unit				2	-ZLC	
			– Slide on right, with clamping unit				2	-ZRC	
M	Protection against particles		Without strip cover					-P0	
			With strip cover					-P9	
O	Additional features		None						
			Food-safe as per supplementary material information				3	-F1	
M	Toothed belt material		Chloroprene rubber					-CR	
			Uncoated PU for the food zone					-PU1	
			Coated PU					-PU2	
O	Displacement encoder system, incremental		None						
			Resolution 2.5 µm					-M1	
	Clamping unit		None						
			– Attached					-C	
	Operating instructions		With operating instructions						
			Without operating instructions					-DN	

- 1** ...H The sum of the nominal stroke and 2x stroke reserve must not exceed the maximum stroke length
- 2** ZL, ZR, ZLC, ZRC Working stroke reduction in combination with additional slide → Page 15
- 3** F1 In conjunction with characteristic F1, select the appropriate toothed belt material

- M** Mandatory data
- O** Options

Transfer order code

Cantilever axes ELCC

Accessories

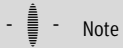
 For the optimum selection of axis/
motor combinations

 → PositioningDrives
engineering software
www.festo.com

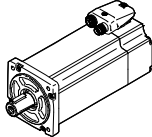
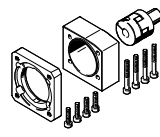
Permissible axis/motor combinations with axial kit		Technical data → Internet: eamm-a	
Motor/gear unit ¹⁾	Axial kit		
			
Type code	Part no.	Type code	
ELCC-TB-KF-60			
With servo motor			
EMME-AS-80-...	8063592	EAMM-A-N48-80P	
With servo motor and gear unit			
EMMT-AS-60-...	1456618	EAMM-A-N48-60H	
EMGA-60-P-G3-EAS-60			
EMME-AS-60-...	1456618	EAMM-A-N48-60H	
EMGA-60-P-G3-EAS-60			
EMME-AS-80-...	1258793	EAMM-A-N48-80G	
EMGA-80-P-G3-EAS-80			
With servo motor and angled gear unit			
EMMT-AS-60-...	1456618	EAMM-A-N48-60H	
EMGA-60-A-G3-60P			
EMME-AS-60-...	1456618	EAMM-A-N48-60H	
EMGA-60-A-G3-60P			
EMME-AS-80-...	1258793	EAMM-A-N48-80G	
EMGA-80-A-G3-80P			
ELCC-TB-KF-70			
With servo motor			
EMME-AS-100-...	1201894	EAMM-A-N48-100A	
With servo motor and gear unit			
EMME-AS-80-...	1258793	EAMM-A-N48-80G	
EMGA-80-P-G3-EAS-80			
EMME-AS-100-...	1258793	EAMM-A-N48-80G	
EMGA-80-P-G3-SAS-100			
With servo motor and angled gear unit			
EMME-AS-80-...	1258793	EAMM-A-N48-80G	
EMGA-80-A-G3-80P			
EMME-AS-100-...	1258793	EAMM-A-N48-80G	
EMGA-80-A-G3-100A			

1) The input torque must not exceed the maximum permissible transferable torque of the axial kit.

Cantilever axes ELCC



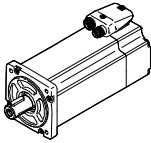
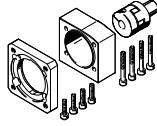

Accessories

Permissible axis/motor combinations with axial kit		Technical data → Internet: eamm-a	
Motor/gear unit ¹⁾	Axial kit		
			
Type code	Part no.	Type code	
ELCC-TB-KF-90			
With servo motor			
EMMS-AS-140-...	1201691	EAMM-A-N80-140A	
With servo motor and gear unit			
EMME-AS-100-... EMGA-80-P-G3-SAS-100	2372096	EAMM-A-N80-80G	
EMME-AS-100-... EMGA-80-P-G5-SAS-100	2372096	EAMM-A-N80-80G	
With servo motor and angled gear unit			
EMME-AS-100-... EMGA-80-A-...-100A	2372096	EAMM-A-N80-80G	
ELCC-TB-KF-110			
With servo motor and gear unit			
EMME-AS-100-... EMGA-80-P-G5-SAS-100	3660191	EAMM-A-L95-80G-G2	
EMMS-AS-140-... EMGA-120-P-G3-SAS-140	3659941	EAMM-A-L95-120G-G2	
With servo motor and angled gear unit			
EMME-AS-100-... EMGA-80-A-G3-100A	3660191	EAMM-A-L95-80G-G2	

1) The input torque must not exceed the maximum permissible transferable torque of the axial kit.

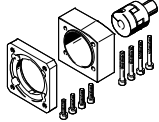
Cantilever axes ELCC

Accessories

Component parts of the axial kit				
Axial kit	Comprises:			
	Motor flange	Coupling	Coupling housing	Screw set
				
Part no. Type code	Part no. Type code	Part no. Type code	Part no. Type code	Part no. Type code
ELCC-TB-KF-60				
8063592 EAMM-A-N48-80P	–	558002 EAMD-42-40-19-16X25	5204317 EAMK-A-N48-80P	–
1456618 EAMM-A-N48-60H	1460111 EAMF-A-48C-60G/H	1377840 EAMD-32-32-14-16X20	1345949 EAMK-A-N48-48C	4984529 EAHM-L5-M6-45
ELCC-TB-KF-70				
1201894 EAMM-A-N48-100A	1201924 EAMF-A-48C-100A	558002 EAMD-42-40-19-16X25	1345949 EAMK-A-N48-48C	1201874 EAHM-L5-M6-50
1258793 EAMM-A-N48-80G	1190375 EAMF-A-48C-80G	1781043 EAMD-42-40-20-16X25-U	1345949 EAMK-A-N48-48C	1201874 EAHM-L5-M6-50
ELCC-TB-KF-90				
1201691 EAMM-A-N80-140A	1190796 EAMF-A-80A-140A	558005 EAMD-56-46-24-23X27	1345953 EAMK-A-N80-80A	1201751 EAHM-L5-M8-75
2372096 EAMM-A-N80-80G	2372201 EAMF-A-80A-80G	558004 EAMD-56-46-20-23X27	1345953 EAMK-A-N80-80A	1201712 EAHM-L5-M8-60
ELCC-TB-KF-110				
3660191 EAMM-A-L95-80G-G2	3305700 EAMF-A-95B-80G	3717812 EAMD-67-51-20-32X32-U	3712650 EAMK-A-L95-95A/B-G2	–
3659941 EAMM-A-L95-120G-G2	3659724 EAMF-A-95A-120G-G2	558006 EAMD-67-51-25-32X32-U	3712650 EAMK-A-L95-95A/B-G2	567496 EAHM-L2-M8-70

Cantilever axes ELCC

Accessories

Switch lug DAYP-E21-SL
For position sensing using a proximity sensor SIEN-8MB

Materials:
Galvanised steel
RoHS-compliant

Sensor bracket DAYP-E21-SR
For proximity sensor SIEN-8MB

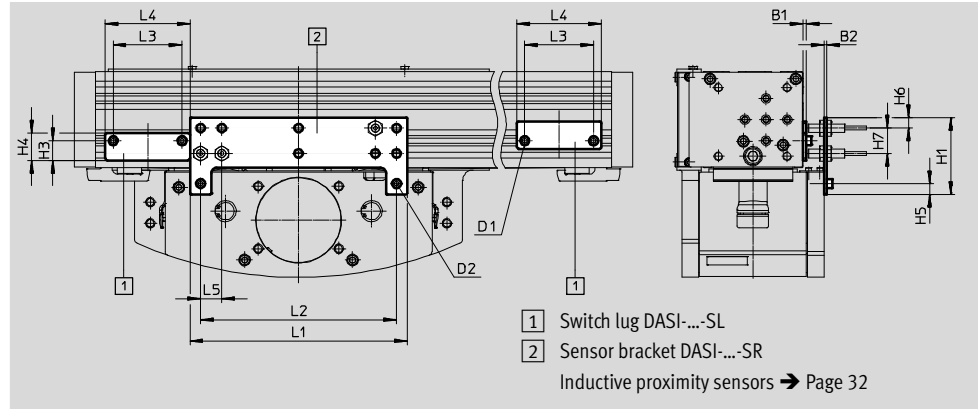

Dimensions and ordering data								
For size	B1	B2	D1	D2	H1	H3	H4	H5
60	3	3	M4	M5	77.8	19	24	10
70	3	3	M4	M5	101.5	16	21	10
90	3	3	M5	M5	72.5	18.5	26	10
110	3	3	M5	M5	83.5	18.5	26	10

For size	H6	H7	L1	L2	L3	L4	L5
60	10	28	140	120	50	60	20
70	10	22	140	120	50	60	20
90	10	24	205	185	65	80	20
110	10	24	230	210	65	80	20

Switch lug				
For size	Weight [g]	Part no.	Type code	PU ¹⁾
60	40	8081324	DASI-E21-60-S8-SL	1
70	36	8081063	DASI-E21-70-S8-SL	
90	77	8081061	DASI-E21-90/110-S8-SL	
110	77	8081061	DASI-E21-90/110-S8-SL	

Sensor bracket				
For size	Weight [g]	Part no.	Type code	PU ¹⁾
60	132	8081066	DASI-E21-60-S8-SR	1
70	225	8081064	DASI-E21-70-S8-SR	
90	247	8081060	DASI-E21-90-S8-SR	
110	326	8081062	DASI-E21-110-S8-SR	

1) Packaging unit quantity

Cantilever axes ELCC

Accessories

Shock absorber retainer DAYP-E21

Materials:
Retainer, stop: Anodised wrought aluminium alloy
RoHS-compliant

 **Note**
The additional length of the profile required for the installation space must be taken into account when ordering the axis (stroke specification).

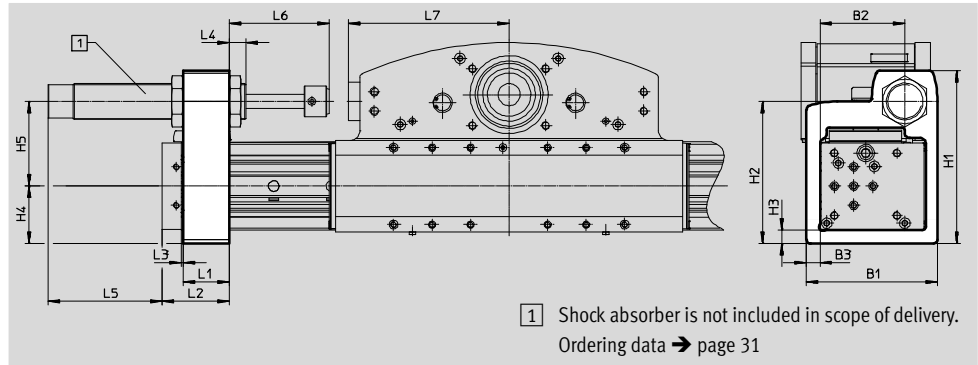

Dimensions and ordering data										
For size	B1	B2	B3	H1	H2	H3	H4	H5	L1	L2 min.
60	78	46	10	120.5	101.5	10	37.5	64	28	50
70	106	70	10	143.5	118	10	44.5	73.5	32	54
90	136	88	14	179.5	147.5	14	59.5	88	48	70
110	178	113	20	218.5	178.5	20	76.5	102	48	70

For size	L3 min.	L4 min.	L5	L6 min.	L7	Weight [g]	Part no.	Type code	PU ¹⁾
60	2	13	41	58.5	126.5	356	8067058	DAYP-E21-60	1
70	2	23	75	84.5	138.5	586	8067060	DAYP-E21-70	
90	2	17	118	104	167	1552	8067062	DAYP-E21-90	
110	2	17	118	104	191	2323	8067064	DAYP-E21-110	

1) Packaging unit quantity

Cantilever axes ELCC

Accessories



Adapter kit DHAA-R

For interface to ISO 9409-1:2004

Materials:

Adapter plate: Wrought aluminium alloy

Screws: Galvanised steel

RoHS-compliant

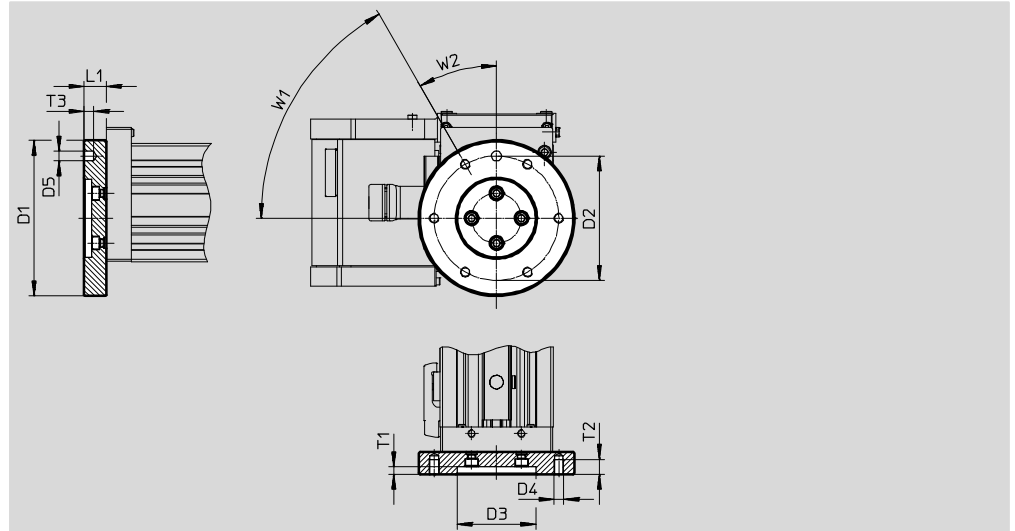
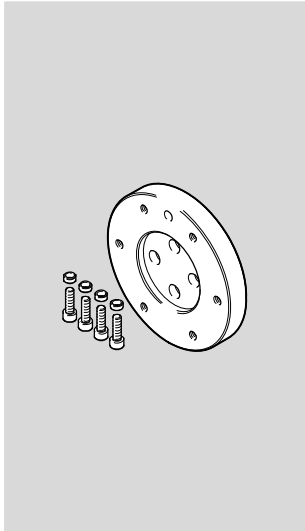







Dimensions and ordering data							
For size	D1	D2	D3	D4	D5	L1	T1
	∅	∅	∅		∅		
	h8		H7		H7		
70	125	100	63	M8	8	18	6
90							
110							

For size	T2	T3	W1	W2	Weight [g]	Part no.	Type code	PU ¹⁾
70	12	8	60°	30°	559	8082459	DHAA-R-E21-70...110RF1-100	1
90								
110								

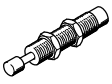
1) Packaging unit quantity

Cantilever axes ELCC



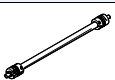

Accessories



Ordering data					
	For size	Manual	Part no.	Type code	PU ¹⁾
Shock absorber YSR					
	60	For use in combination with shock absorber retainer DAYP-E21	34574	YSR-20-25-C	1
	70		160273	YSR-25-40-C	
	90, 110		160274	YSR-32-60-C	
Slot nut NST					
	60, 70	For profile slot	150914	NST-5-M5	1
			8047843	NST-5-M5-10	10
			8047878	NST-5-M5-50	50
	90, 110	For profile slot	150915	NST-8-M6	1
			8047868	NST-8-M6-10	10
			8047869	NST-8-M6-50	50
Centring pin ZBS/centring sleeve ZBH					
	60	For mounting the drive head	150928	ZBS-5	10
	70, 90		150927	ZBH-9	
	110		189653	ZBH-12	
	60, 70	For centring on the front end	186717	ZBH-7	
	70, 90, 110		150927	ZBH-9	
Slot cover ABP					
	60, 70	<ul style="list-style-type: none"> • For mounting slot • Every 0.5 m 	151681	ABP-5	2
	90, 110		151682	ABP-8	
Drive shaft EAMB					
	60, 70	<ul style="list-style-type: none"> • Can, if required, be used as an alternative interface • No drive shaft is required for the axis/motor combinations → page 25 	558036	EAMB-24-6-15X21-16X20	1
	90		558037	EAMB-34-6-25X26-23X27	
	110		558038	EAMB-44-7-35X30-32X32	
Clamping element EADT					
	60	Tool for retensioning the cover strip	8058451	EADT-S-L5-70	1
	70, 90		8097157	EADT-S-L5-90	
	110		8058450	EADT-S-L5-120	
Connecting shaft KSK					
	60, 70	<ul style="list-style-type: none"> • For torsion-resistant transmission of torques • For slip-free transmission of feed rates • To operate two cantilever axes in parallel using one motor 	562521	KSK-80-	1
	90		562522	KSK-120-	
	110		562523	KSK-185-	

1) Packaging unit quantity

Cantilever axes ELCC

Accessories

Ordering data – Proximity sensor M8 (round design), inductive					Technical data → Internet: sien	
	Electrical connection	LED	Switching output	Cable length [m]	Part no.	Type code
N/O contact						
	Cable, 3-wire	■	PNP	2.5	150386	SIEN-M8B-PS-K-L
			NPN	2.5	150384	SIEN-M8B-NS-K-L
	Plug M8x1, 3-pin	■	PNP	–	150387	SIEN-M8B-PS-S-L
			NPN	–	150385	SIEN-M8B-NS-S-L
N/C contact						
	Cable, 3-wire	■	PNP	2.5	150390	SIEN-M8B-PO-K-L
			NPN	2.5	150388	SIEN-M8B-NO-K-L
	Plug M8x1, 3-pin	■	PNP	–	150391	SIEN-M8B-PO-S-L
			NPN	–	150389	SIEN-M8B-NO-S-L

Ordering data – Connecting cables				Technical data → Internet: nebu	
	Electrical connection, left	Electrical connection, right	Cable length [m]	Part no.	Type code
	Straight socket, M8x1, 3-pin	Cable, open end, 3-wire	2.5	159420	SIM-M8-3GD-2,5-PU
			2.5	541333	NEBU-M8G3-K-2.5-LE3
			5	541334	NEBU-M8G3-K-5-LE3
	Angled socket, M8x1, 3-pin	Cable, open end, 3-wire	2.5	541338	NEBU-M8W3-K-2.5-LE3
			5	541341	NEBU-M8W3-K-5-LE3

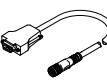
Ordering data – Encoder cables for displacement encoder system ELCC-...-M1				Technical data → Internet: nebm	
	Electrical connection, left	Electrical connection, right	Cable length [m]	Part no.	Type code
	Displacement encoder system ELCC-...-M1	Motor controller CMMP-AS	5	1599105	NEBM-M12G8-E-5-S1G9-V3
			10	1599106	NEBM-M12G8-E-10-S1G9-V3
			15	1599107	NEBM-M12G8-E-15-S1G9-V3
			χ ¹⁾	1599108	NEBM-M12G8-E-...-S1G9-V3

1) Max. cable length 25 m.