

## Pinch valves VZQA

**FESTO**



Festo core product range  
Covers 80% of your automation tasks

Worldwide:

Always in stock

Superb:

Festo quality at an attractive price

Easy:

Reduces procurement and storing complexity



Generally ready for shipping ex works in 24 hours  
Held in stock in 13 service centres worldwide  
More than 2200 product



Generally ready for shipping ex works in 5 days  
Assembled for you in 4 service centres worldwide  
Up to 6 x 10<sup>12</sup> variants per product series

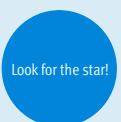

# Pinch valves VZQA

Key features

Application	Design	Areas of application	Examples of operating media:
<ul style="list-style-type: none"> <li>The pinch valve is a 2/2-way valve used to control liquid and powdery media, solids as well as a mixture of substances.</li> </ul>	<ul style="list-style-type: none"> <li>Easy-to-clean housing (clean design)</li> <li>Open or closed in normal position</li> <li>Shut-off element made of elastomer</li> </ul>	<ul style="list-style-type: none"> <li>Filling systems</li> <li>Dosing and weighing systems</li> <li>Powder coating systems</li> <li>Suction and compressed air control units</li> <li>Pneumatic delivery systems</li> <li>Sandblast systems</li> </ul>	<ul style="list-style-type: none"> <li>Granules</li> <li>Powder</li> <li>Dust</li> <li>Liquids containing solids</li> <li>Fibrous products</li> <li>Highly viscous media</li> <li>Abrasive media</li> <li>Corrosive media</li> <li>Paste-like media</li> </ul>

## Function

The pinch valve is a 2/2-way valve with a tubular pinch sleeve made of elastomer. The free passage when the valve is opened ensures minimum flow resistance and prevents the valve becoming blocked or clogged.

### VZQA-C-M22C (normally closed)

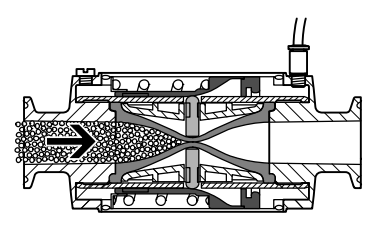

In the normal position, the pinch valve is closed. The pinch valve sleeve opens when the valve is pressurised, releasing the material flow. When pressure is no longer applied, a spring closes the valve. The valve can be used to shut off liquid and gaseous media.

### VZQA-C-M22U (normally open)

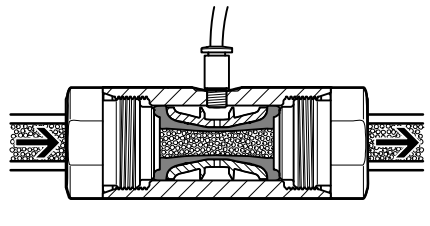

In the normal position, the pinch valve is open. The pinch valve sleeve closes when the valve is pressurised, shutting off the material flow. When pressure is no longer applied, the valve opens due to the inherent stress of the pinch valve sleeve or the pressure of the medium. The valve can be used to shut off liquid and powdery media, solids (granules) as well as a mixture of substances.

**Note**

The hermetic separation between the media circuit and control circuit is no longer guaranteed if wear causes the pinch valve sleeve to leak. The flow medium can then get into the control circuit, from where it can escape. Any potential hazard (e.g. due to aggressive or hot media) must be ruled out. The compressed air supply to the control valve must be protected against the ingress of the flow medium using a suitable check valve, or suitable protection against return flow must be integrated in the pilot line in the immediate vicinity of the media valve. Pilot medium can get into the media circuit if the pinch valve sleeve fails. The media circuit must therefore be sized for the set operating pressure. Any potential hazard must be ruled out.

# Pinch valves VZQA

Product range overview

FESTO

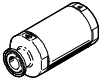
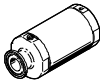
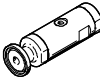
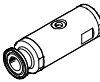
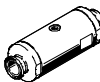
Version		Type	Nominal width DN	Process valve connection	Flow rate [m <sup>3</sup> /h]	Pilot air connection 12, max. permissible screw-in depth	→ Page/ Internet
Normally closed	<b>M22C</b>						
		VZQA-C-M22C-...	6	G1/4	0.7	M3, 3 mm	6
				1/4 NPT			
				Clamp ferrule to DIN 32676, series A			
				Clamp ferrule to ASME-BPE, type A			
		VZQA-C-M22C-...	15	G1/2	5	M5, 5 mm	6
1/2 NPT							
Clamp ferrule to DIN 32676, series A							
Clamp ferrule to ASME-BPE, type A							
Normally open	<b>M22U</b>						
		VZQA-C-M22U-...	6	G1/4	0.7	M5, 4.5 mm	9
				1/4 NPT			
				Clamp ferrule to DIN 32676, series A			
				Clamp ferrule to ASME-BPE, type A			
		VZQA-C-M22U-...	15	G1/2	5	G1/8, 5 mm	9
				1/2 NPT			
				Clamp ferrule to DIN 32676, series A			
				Clamp ferrule to ASME-BPE, type A			
	VZQA-C-M22U-...	25	G1	18	G1/8, 6 mm	9	
			1 NPT				
			Clamp ferrule to DIN 32676, series A				
			Clamp ferrule to ASME-BPE, type B				

# Pinch valves VZQA

Peripherals overview

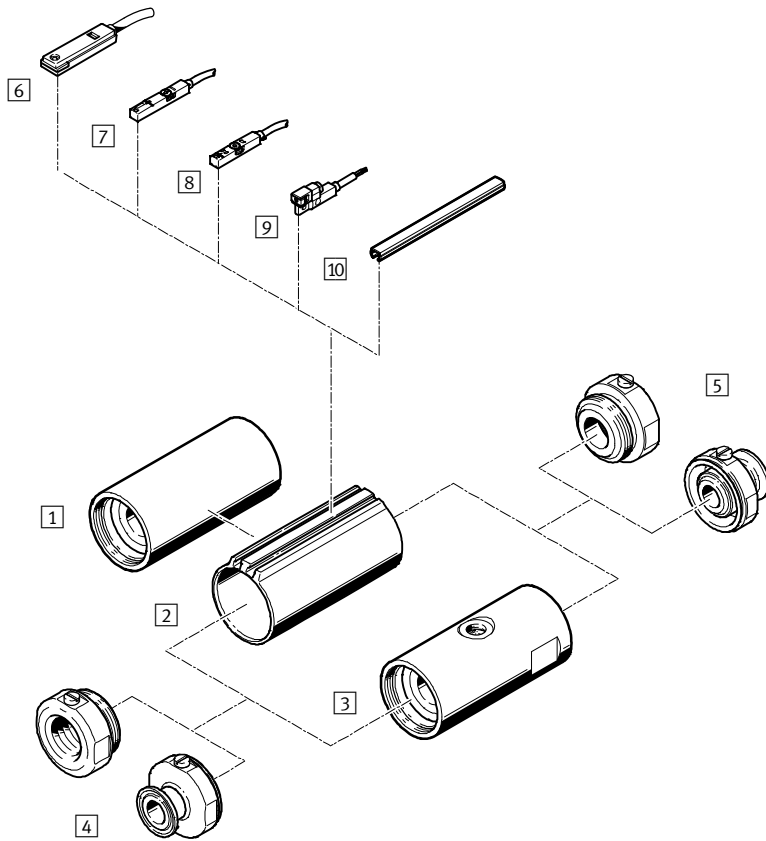

Accessories	Description	→ Page/Internet
Basic body		6
[1] VZQA-C-M22C	<ul style="list-style-type: none"> <li>• Normally closed</li> <li>• "Stainless steel housing material" variant</li> </ul>	
[2] VZQA-C-M22C	<ul style="list-style-type: none"> <li>• Normally closed</li> <li>• "Aluminium housing material" variant (always with T-slots)</li> <li>• Integrated ring magnet only available when "End-position sensing type" is selected</li> </ul>	
[3] Basic body VZQA-C-M22U	Normally open	9
[4] Connection 1	Various connections are available: <ul style="list-style-type: none"> <li>• G female thread</li> <li>• NPT female thread</li> <li>• Clamp ferrule DIN 32676, series A</li> <li>• Clamp ferrule ASME-BPE, type A</li> <li>• Clamp ferrule ASME-BPE, type B</li> </ul>	-
[5] Connection 2	Various connections are available: <ul style="list-style-type: none"> <li>• G female thread</li> <li>• NPT female thread</li> <li>• Clamp ferrule DIN 32676, series A</li> <li>• Clamp ferrule ASME-BPE, type A</li> <li>• Clamp ferrule ASME-BPE, type B</li> </ul>	-
Proximity sensors for T-slot		14
[6] SME-8	Magnetic reed, insertable in the slot lengthwise	
[7] SME-8M	Magnetic reed, insertable in the slot from above	
[8] SMT-8M	Magnetoresistive, insertable in the slot from above, to EU Explosion Protection Directive	
[9] SMT-8G	Magnetoresistive, insertable in the slot lengthwise	
[10] Slot cover ABP-5-S	To protect the sensor cables and slots from contamination	15

# Pinch valves VZQA

Type codes

VZQA - C - M22U - 6 - G G - V4 V4 N - 4 - E

### Type

VZQA	Pinch valve, pneumatically actuated
------	-------------------------------------

### Product version

C	Easy-to-clean design
---	----------------------

### Valve function

M22C	2/2-way valve, normally closed
M22U	2/2-way valve, normally open

### Nominal diameter DN

6	6 mm
15	15 mm
25	25 mm

### Process valve connection type 1

G	G female thread
T	NPT female thread
S1	Clamp ferrule to ASME-BPE, type A
S5	Clamp ferrule to DIN 32676, series A
S12	Clamp ferrule to ASME-BPE, type B

### Process valve connection type 2

G	G female thread
T	NPT female thread
S1	Clamp ferrule to ASME-BPE, type A
S5	Clamp ferrule to DIN 32676, series A
S12	Clamp ferrule to ASME-BPE, type B

### Housing material

AL	Aluminium
V2	Stainless steel (chrome-nickel, austenitic)
V4	Stainless steel (chrome-nickel-molybdenum, austenitic)

### Housing cover material

Al	Aluminium
V4	Stainless steel (chrome-nickel-molybdenum, austenitic)
POM	Polyoxymethylene

### Shut-off element material

E	EPDM
N	NBR
S1	Silicone

### Pressure range of media

4	0 ... 4 bar
6	0 ... 6 bar

### Sensing type

-	None
E	End positions

# Pinch valves VZQA

Technical data M22C

FESTO

Function



General technical data		
Nominal width DN	6	15
Process valve nominal pressure PN	10	
Design	Pinch valve, pneumatically actuated	
Actuation type	Pneumatic	
Sealing principle	Soft	
Mounting position	Any	
Valve function	2/2-way, closed, monostable	
Flow direction	Reversible	
Reset method	Mechanical spring	
Type of control	Externally controlled	
Type of mounting	In-line installation	
Auxiliary pilot air connection 12	M3	M5
Switching time on [ms]	125	150
Switching time off [ms]	125	250
Flow rate Kv [m <sup>3</sup> /h]	0.7	5
Max. viscosity [mm <sup>2</sup> /s]	4000	

Operating and environmental conditions		
Nominal width DN	6	15
Operating pressure [bar]	3.5 ... 6	
Burst pressure [bar]	16	
Pressure of medium [bar]	0 ... 4	0 ... 6
Ambient temperature [°C]	-5 ... +60	
Temperature of medium [°C]	-15 ... +50	-5 ... +100
Storage temperature [°C]	6 ... 8	
Food-safe <sup>1)</sup>	See supplementary material information	
Pilot medium	Compressed air to ISO 8573-1:2010 [7:4:1]	
Medium	Compressed air to ISO 8573-1:2010 [-:~:1]	
	Water	

1) Additional information [www.festo.com/sp](http://www.festo.com/sp) → Certificates.

Materials	Material number	
Housing		
V2V4	High-alloy stainless steel	1.4301
ALV4	Wrought aluminium alloy	-
Housing cover	High-alloy stainless steel	1.4435
Bowl	PA6	
Seals	FPM	
Shut-off element	EPDM	
Note on materials	RoHS-compliant	
	Contains PWIS (paint-wetting impairment substances)	

# Pinch valves VZQA

Technical data M22C

## Dimensions

Download CAD data → [www.festo.com](http://www.festo.com)

Illustration – connection 1: clamp ferrule to DIN 32676, series A; connection 2: G1/2

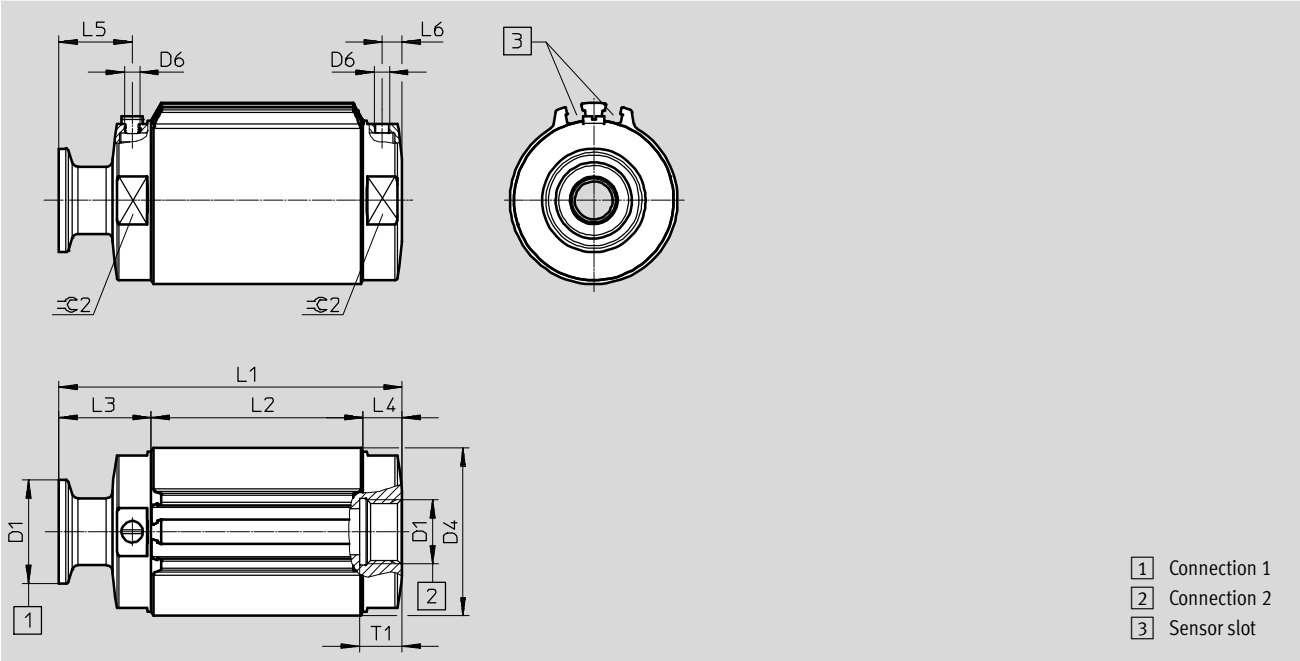

- 1 Connection 1
- 2 Connection 2
- 3 Sensor slot

Process valve connection	D1	Material Housing	D4 Ø	D6	L2	L3	L4	L5	L6	T1	≈C 2
<b>Nominal width DN6</b>											
G	G1/4	V2	33.6	M3	47.2	10.9	10.9	4.8	4.8	12	32
T	1/4 NPT					10.9	10.9	4.8	4.8	10	
S5	DIN 32676, series A					24	24	17.9	17.9	–	
S1	ASME-BPE, type A					24	24	17.9	17.9	–	
<b>Nominal width DN15</b>											
G	G1/2	V2	52.4	M5	69.5	12.8	12.8	6.6	6.6	14	50
		AL	55			12.8	12.8	6.6	6.6		
T	1/2 NPT	V2	52.4			12.8	12.8	6.6	6.6		
		AL	55			12.8	12.8	6.6	6.6		
S5	DIN 32676, series A	V2	55	30.3	30.3	24	24				
S1	ASME-BPE, type A	V2	55	30.3	30.3	24	24				





Process valve combinations	L1
<b>Nominal width DN6</b>	
GG	69
GT, TT, TG	69
S1S1, S1S5, S5S5, S5S1	95.1
S1G, S1T, GS1, TS1, S5G, S5T, GS5, TS5	82.1
<b>Nominal width DN15</b>	
GG	95
GT, TT, TG	95
S1S1, S1S5, S5S5, S5S1	130
S1G, S1T, GS1, TS1, S5G, S5T, GS5, TS5	112.5

# Pinch valves VZQA

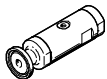
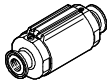
Technical data M22C

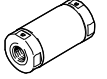
★ **Core product range**

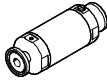
Ordering data						
Pinch valves	Nominal width DN	Process valve connection	Material shut-off element	Weight [g]	Part no.	Type
	15	G1/2	EPDM	536	★ 3412426	VZQA-C-M22C-15-GG-V2V4E-6
		Clamp ferrule to DIN 32676, series A		666	★ 3412424	VZQA-C-M22C-15-S5S5-V2V4E-6
With integrated ring magnet for sensing the end positions						
	15	Clamp ferrule to DIN 32676, series A	EPDM	607	★ 3412425	VZQA-C-M22C-15-S5S5-ALV4E-6-E

Ordering data						
Pinch valves	Nominal width DN	Process valve connection	Material shut-off element	Weight [g]	Part no.	Type
	6	G1/4	EPDM	253	8091739	VZQA-C-M22C-6-GG-V2V4E-4 
		1/4 NPT		253	4748311	VZQA-C-M22C-6-TT-V2V4E-4 
	6	Clamp ferrule to DIN 32676, series A	EPDM	302	8079858	VZQA-C-M22C-6-S1S1-V2V4E-4 
		Clamp ferrule to ASME-BPE, type A		311	8079857	VZQA-C-M22C-6-S5S5-V2V4E-4 

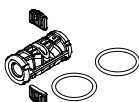
Ordering data						
Seal cartridge	Nominal width DN	Storage temperature [°C]	Shut-off element material	Note on materials	Part no.	Type
	15	6 ... 8	EPDM	RoHS-compliant	3418619	VAVC-Q2-M22C-15-E

Festo core product range

- ★ Generally ready for shipping ex works in 24 hours
- ☆ Generally ready for shipping ex works in 5 days



# Pinch valves VZQA

Technical data M22U

FESTO

Function



General technical data				
Nominal width DN		6	15	25
Process valve nominal pressure PN	10			
Design	Pinch valve, pneumatically actuated			
Actuation type	Pneumatic			
Sealing principle	Soft			
Mounting position	Any			
Valve function	2/2-way, open, monostable			
Flow direction	Reversible			
Reset method	Rebound resilience			
Type of control	Externally controlled			
Type of mounting	In-line installation			
Auxiliary pilot air connection 12	M5	G1/8	G1/8	
Switching time on	[ms]	125	250	250
Switching time off	[ms]	125	250	250
Flow rate Kv	[m <sup>3</sup> /h]	0.7	5	18
Max. viscosity	[mm <sup>2</sup> /s]	4000		

Materials				
VZQA-C-M22U-...	V4V4	ALAL	ALV4	ALPOM
Housing	High-alloy stainless steel	Wrought aluminium alloy		
Housing cover	High-alloy stainless steel	Wrought aluminium alloy	High-alloy stainless steel	POM
Bowl	PA6			
Seals	FPM			
Note on materials				
For shut-off element NBR, EPDM or VMQ	RoHS-compliant			
For shut-off element VMQ	Contains PWIS (paint-wetting impairment substances)			

# Pinch valves VZQA

Technical data M22U

FESTO

Operating and environmental conditions			
Nominal width DN		6	15
			25
Operating pressure	[bar]	1 ... 6.5	
Overload pressure	[bar]	7.8	
Pressure of medium	[bar]	0 ... 4	
Differential pressure			
For shut-off element NBR or EPDM	[bar]	2.5	2.5
For shut-off element VMQ	[bar]	2.5	3
Burst pressure	[bar]	16	
Ambient temperature	[°C]	-5 ... +60	
Temperature of medium			
For shut-off element NBR	[°C]	-5 ... +60	
For shut-off element EPDM	[°C]	-5 ... +100	
For shut-off element VMQ	[°C]	-5 ... +150	
Storage temperature			
For shut-off element NBR or EPDM	[°C]	6 ... 8	
For shut-off element VMQ	[°C]	0 ... 25	
Food-safe			
For shut-off element EPDM		See supplementary material information <sup>1)</sup>	
For shut-off element NBR or VMQ		See declaration of conformity	
Pilot medium			
For shut-off element EPDM		Compressed air to ISO 8573-1:2010 [7:4:1]	
For shut-off element NBR or VMQ		Compressed air to ISO 8573-1:2010 [7:4:4]	
Medium			
For shut-off element EPDM		Compressed air to ISO 8573-1:2010 [:-:1]	
		Water	
For shut-off element NBR or VMQ		Compressed air to ISO 8573-1:2010 [:-:]	

1) Additional information [www.festo.com/sp](http://www.festo.com/sp) → Certificates.

# Pinch valves VZQA

Technical data M22U

FESTO

## Dimensions

Download CAD data → [www.festo.com](http://www.festo.com)

Illustration – connection 1: clamp ferrule to DIN 32676, series A; connection 2: G1/2

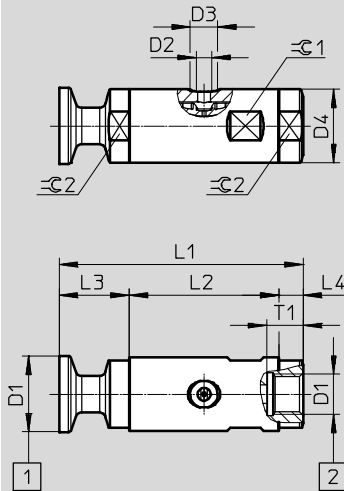

1 Connection 1  
2 Connection 2

Process valve connection	D1	Material housing cover	D2	D3 Ø	D4 Ø	L2	L3	L4	T1	≙ 1	≙ 2
<b>Nominal width DN6</b>											
G	G1/4	V4, AL	M5	9	24	49	8	8	12	22	22
T	1/4 NPT	V4, AL					8	8			
S5	DIN 32676, series A	V4					23	23			
S1	ASME-BPE, type A	V4					23	23			
<b>Nominal width DN15</b>											
G	G1/2	V4, AL	G1/8	15	38	81	7	7	14	36	36
		POM					12	12			
T	1/2 NPT	V4, AL					7	7			
		POM					12	12			
S5	DIN 32676, series A	V4	24.5	24.5							
S1	ASME-BPE, type A	V4	24.5	24.5							
<b>Nominal width DN25</b>											
G	G1	V4, AL	G1/8	15	58	109	10.5	10.5	18	55	55
		POM					15.5	15.5			
T	1 NPT	V4, AL					10.5	10.5			
		POM					15.5	15.5			
S5	DIN 32676, series A	V4	28	28							
S1	ASME-BPE, type A	V4	28	28							
S12	ASME-BPE, type B	V4	28	28							

Process valve combinations	L1		
	Nominal width DN6	Nominal width DN15	Nominal width DN25
GG, GT, TT, TG made of V4 or AL	65	95	130
GG, GT, TT, TG made of POM	–	105	140
GG, GT, TT, TG made of V4 or AL with POM	–	100	135
S1S1, S1S5, S5S5, S5S1, S1S12, S12S1, S5S12, S12S5, S12S12	80	130	165
S1G, S1T, GS1, TS1, S5G, S5T, GS5, TS5, S12G, S12T, GS12, TS12	95	112.5	147.5

# Pinch valves VZQA

Technical data M22U

FESTO

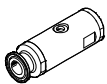
Ordering data							
Pinch valves	Nominal width DN	Process valve connection	Material shut-off element	Weight [g]	Part no.	Type	
							6
			EPDM	157	2931678	VZQA-C-M22U-6-GG-V4V4E-4	
			Silicone	157	2931683	VZQA-C-M22U-6-GG-V4V4S1-4	
		1/4 NPT	Silicone	157	2931685	VZQA-C-M22U-6-TT-V4V4S1-4	
		Clamp ferrule to DIN 32676, series A	EPDM	215	2931681	VZQA-C-M22U-6-S5S5-V4V4E-4	
			Silicone	215	2931682	VZQA-C-M22U-6-S5S5-V4V4S1-4	
		Clamp ferrule to ASME-BPE, type A	Silicone	195	2931684	VZQA-C-M22U-6-S1S1-V4V4S1-4	
	15	G1/2	NBR	431	3022830	VZQA-C-M22U-15-GG-V4V4N-4	
			NBR	265	3022831	VZQA-C-M22U-15-GG-ALV4N-4	
			NBR	158	3022832	VZQA-C-M22U-15-GG-ALPOMN-4	
			EPDM	431	3022829	VZQA-C-M22U-15-GG-V4V4E-4	
			Silicone	431	3022835	VZQA-C-M22U-15-GG-V4V4S1-4	
		1/2 NPT	Silicone	431	3022838	VZQA-C-M22U-15-TT-V4V4S1-4	
		Clamp ferrule to DIN 32676, series A	EPDM	559	3022833	VZQA-C-M22U-15-S5S5-V4V4E-4	
			Silicone	559	3022834	VZQA-C-M22U-15-S5S5-V4V4S1-4	
		Clamp ferrule to ASME-BPE, type A	Silicone	495	3022837	VZQA-C-M22U-15-S1S1-V4V4S1-4	
	25	G1	EPDM	1178	3968922	VZQA-C-M22U-25-GG-V4V4E-4	
			EPDM	480	3968923	VZQA-C-M22U-25-GG-ALALE-4	
			Silicone	1178	3968926	VZQA-C-M22U-25-GG-V4V4S1-4	
		1 NPT	Silicone	1178	3968928	VZQA-C-M22U-25-TT-V4V4S1-4	
		Clamp ferrule to DIN 32676, series A	EPDM	1474	3968924	VZQA-C-M22U-25-S5S5-V4V4E-4	
			Silicone	1474	3968925	VZQA-C-M22U-25-S5S5-V4V4S1-4	
		Clamp ferrule to ASME-BPE, type B	Silicone	1516	3968927	VZQA-C-M22U-25-S12S12-V4V4S1-4	

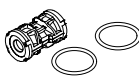
Ordering data							
Seal cartridge	Nominal width DN	Material shut-off element	Storage temperature [°C]	Note on materials	Food-safe	Part no.	Type
							
		EPDM				1)	2392882 VAVC-Q2-M22U-6-E
		VMQ (silicone)	0 ... 25	Contains PWIS (paint-wetting impairment substances)		2)	2392883 VAVC-Q2-M22U-6-S1
	15	NBR	6 ... 8	–		–	3019151 VAVC-Q2-M22U-15-N
		EPDM				1)	3019148 VAVC-Q2-M22U-15-E
		VMQ (silicone)	0 ... 25	Contains PWIS (paint-wetting impairment substances)		2)	3019144 VAVC-Q2-M22U-15-S1
	25	NBR	6 ... 8	–		–	★ 3970092 VAVC-Q2-M22U-25-N
		EPDM				–	3970093 VAVC-Q2-M22U-25-E
		VMQ (silicone)	0 ... 25	Contains PWIS (paint-wetting impairment substances)		2)	3970094 VAVC-Q2-M22U-25-S1

- 1) See supplementary material information  
Additional information [www.festo.com/sp](http://www.festo.com/sp) → Certificates.
- 2) See declaration of conformity

Festo core product range ★ Generally ready for shipping ex works in 24 hours  
☆ Generally ready for shipping ex works in 5 days

# Pinch valves VZQA

Ordering data – Modular product system

Ordering table					
VZQA-C-...	M22C	M22U	Conditions	Code	Enter code
<b>M</b> Module no.	<b>3174282</b>	<b>2037881</b>			
Product type	Pinch valve			<b>VZQA</b>	VZQA
Version	Easy-to-clean design			<b>-C</b>	-C
Valve function	2/2-way valve, normally closed	–		<b>-M22C</b>	
	–	2/2-way valve, normally open		<b>-M22U</b>	
Nominal diameter DN	6			<b>-6</b>	
	15			<b>-15</b>	
	–	25		<b>-25</b>	
Process valve connection type 1	G female thread			<b>-G</b>	
	Clamp ferrule to ASME-BPE, type A		<b>1</b> <b>4</b>	<b>-S1</b>	
	Clamp ferrule to DIN 32676, series A		<b>1</b>	<b>-S5</b>	
	NPT female thread			<b>-T</b>	
	Clamp ferrule to ASME-BPE, type B		<b>1</b> <b>3</b> <b>4</b> <b>6</b>	<b>-S12</b>	
Process valve connection type 2	G female thread			<b>G</b>	
	Clamp ferrule to ASME-BPE, type A		<b>1</b> <b>4</b>	<b>S1</b>	
	Clamp ferrule to DIN 32676, series A		<b>1</b>	<b>S5</b>	
	NPT female thread			<b>T</b>	
	Clamp ferrule to ASME-BPE, type B		<b>1</b> <b>3</b> <b>4</b> <b>6</b>	<b>S12</b>	
Housing material	Aluminium			<b>-AL</b>	
	Stainless steel (chrome-nickel, austenitic)	–		<b>-V2</b>	
	–	Stainless steel (chrome-nickel-molybdenum, austenitic)		<b>-V4</b>	
Housing cover material	Aluminium			<b>AL</b>	
	–	Polyoxymethylene	<b>3</b>	<b>POM</b>	
	Stainless steel (chrome-nickel-molybdenum, austenitic)			<b>V4</b>	
Shut-off element material	EPDM			<b>E</b>	
	–	NBR		<b>N</b>	
	–	Silicone		<b>S1</b>	
Pressure range of media [bar]	0 ... 4		<b>7</b>	<b>-4</b>	
	0 ... 6	–	<b>3</b>	<b>-6</b>	
<b>O</b> Sensing type	None				
	End positions		<b>2</b> <b>5</b>	<b>-E</b>	

- 1** **S1, S5, S12** Only in combination with housing cover material V4 (stainless steel)
- 2** **E** Only in combination with valve function M22C
- 3** **POM, S12, 6** Not in combination with nominal diameter DN6
- 4** **S1, S12** Not in combination with nominal diameter DN25 with valve function M22C
- 5** **E** Not in combination with housing material V2 (stainless steel)
- 6** **S12** Not in combination with nominal diameter DN15
- 7** **4** Not in combination with nominal diameter DN15 with valve function M22C

**M** Mandatory data  
**O** Options

**Transfer order code**

**VZQA** - **C** -  -  -   -    -  -

# Pinch valves VZQA

Accessories

FESTO

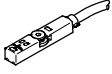
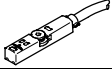
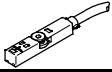
Ordering data – Proximity sensors for T-slot, magnetoresistive					Technical data → Internet: smt-8	
Switching output	Electrical connection			Cable length [m]	Part no.	Type
	Cable	Cable with plug, rotatable thread				
		M8x1	M12x1			
<b>N/O contact</b>						
	PNP	–	3-pin	–	0.3	★ 574334 SMT-8M-A-PS-24V-E-0,3-M8D
		3-wire	–	–	2.5	★ 574335 SMT-8M-A-PS-24V-E-2,5-OE
		3-wire	–	–	5	★ 574336 SMT-8M-A-PS-24V-E-5,0-OE
		–	–	3-pin	0.3	★ 574337 SMT-8M-A-PS-24V-E-0,3-M12
	NPN	3-wire	–	–	2.5	★ 574338 SMT-8M-A-NS-24V-E-2,5-OE
		–	3-pin	–	0.3	★ 574339 SMT-8M-A-NS-24V-E-0,3-M8D
	To EU Explosion Protection Directive (ATEX)					
Non-contacting	2-wire	–	–	5	★ 574341 SMT-8M-A-ZS-24V-E-5,0-OE-EX2	
PNP	–	3-pin	–	0.3	574342 SMT-8M-A-PS-24V-E-0,3-M8D-EX2	
<b>N/C contact</b>						
	PNP	3-wire	–	–	7.5	★ 574340 SMT-8M-A-PO-24V-E-7,5-OE
<b>Switchable</b>						
	PNP/NPN	–	3-pin	–	0.3	574343 SMT-8M-A-PNS-24V-E-0,3-M8D
	PNP PS/PO	–	3-pin	–	0.3	574344 SMT-8M-A-PSO-24V-E-0,3-M8D

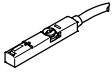
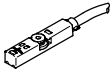
Ordering data – Proximity sensors for T-slot, magnetic reed					Technical data → Internet: sme-8	
Switching output	Electrical connection			Cable length [m]	Part no.	Type
	Cable	Cable with plug, rotatable thread				
		M8x1				
<b>N/O contact</b>						
	Contacting, bipolar	–	3-pin	–	0.3	★ 543861 SME-8M-DS-24V-K-0,3-M8D
		3-wire	–	–	2.5	★ 543862 SME-8M-DS-24V-K-2,5-OE
		3-wire	–	–	5	★ 543863 SME-8M-DS-24V-K-5,0-OE
		2-wire	–	–	2.5	★ 543872 SME-8M-ZS-24V-K-2,5-OE
		3-wire	–	–	7.5	543876 SME-8M-DS-24V-K-7,5-OE
<b>N/C contact</b>						
	Contacting, bipolar	3-wire	–	–	7.5	★ 546799 SME-8M-DO-24V-K-7,5-OE

Festo core product range



★ Generally ready for shipping ex works in 24 hours



☆ Generally ready for shipping ex works in 5 days

# Pinch valves VZQA

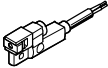
Accessories

FESTO

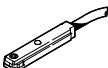
Ordering data – Proximity sensors for T-slot, magnetoresistive					Technical data → Internet: smt-8	
	Switching output	Electrical connection		Cable length [m]	Part no.	Type
		Cable	Plug M8x1			
N/O contact						
	PNP	3-wire	–	2.5	547859	SMT-8G-PS-24V-E-2,5Q-OE
		–	3-pin	0.3	547860	SMT-8G-PS-24V-E-0,3Q-M8D
	PNP	–	3-pin	–	562019	SMT-8-SL-PS-LED-24-B

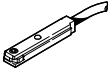
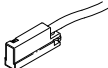
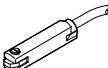
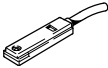
Ordering data – Proximity sensors for T-slot, magnetic reed					Technical data → Internet: sme-8	
	Switching output	Electrical connection		Cable length [m]	Part no.	Type
		Cable	Plug M8x1			
N/O contact						
	Contacting, bipolar	3-wire	–	2.5	150855	SME-8-K-LED-24
		3-wire	–	5.0	175404	SME-8-K5-LED-24
		3-wire	–	7.5	530491	SME-8-K-7,5-LED-24
		–	3-pin	0.3	150857	SME-8-S-LED-24
		2-wire	–	2.5	171169	SME-8-ZS-KL-LED-24
	Contacting, bipolar	–	3-pin	–	526622	SME-8-SL-LED-24
	Contacting, bipolar, heat-resistant	2-wire	–	2.5	161756	SME-8-K-24-S6
	Contacting, bipolar, operating voltage range up to 230 V AC/DC	2-wire	–	2.5	152820	SME-8-K-LED-230
	Contacting, bipolar	3-wire	–	1	562515	SME-8-FM-DS-24V-K-1,0-OE
		2-wire	–	1	562516	SME-8-FM-ZS-24V-K-1,0-OE
N/C contact						
	Contacting, bipolar	3-wire	–	7.5	160251	SME-8-O-K-LED-24

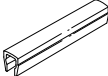
Ordering data – Slot cover for T-slot			
	Mounting	Length [m]	Part no. Type
	Insertable	2x 0.5	151680 ABP-5-S