

Proportional directional control valves MPYE

FESTO



Key features



General

The directly actuated proportional directional control valve has a position-controlled spool. This converts an analogue input signal into a corresponding opening cross-section at the valve outputs.

In combination with an external position controller and displacement encoder, this can be used to create a precise pneumatic positioning system.

- Flow control function for varying the cylinder speed
- 5/3-way function for varying the direction of movement

Wide choice of variants

- Setpoint input
 - Analogue voltage signal
 - Analogue current signal
- Flow rates from 100 ... 2000 l/min

Key features

Short machine cycle times – fast switching of programmed flow rates

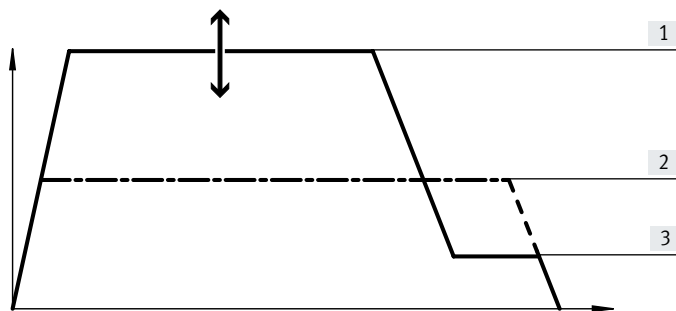

Y-axis: Cylinder speed
X-axis: Cylinder stroke
— A – Proportional valve
- - - - B – Switching valve

Optimising the cylinder speeds reduces machine cycle times

- Assembly technology
- Handling technology
- Furniture industry

A: Proportional valves allow different speed levels ([1] Fast, [3] Creep) and speed ramps to be set.

B: Speed regulation using switching valves requires exhaust air flow control and is very inflexible (only [2] Medium speed).

Flexible cylinder speeds – achieving variable flow rates

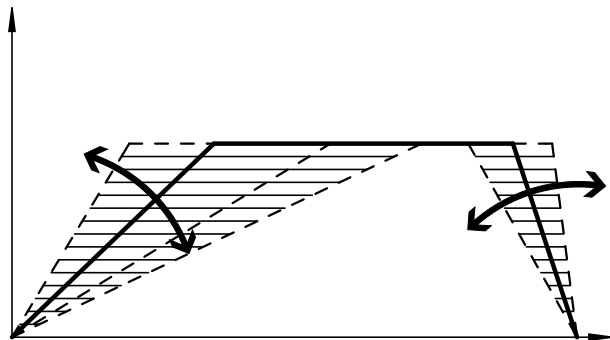

Y-axis: Cylinder speed
X-axis: Cylinder stroke

Adapt cylinder speeds flexibly to the process.

Make use of custom acceleration ramps (gentle start for sensitive items)

- Automotive suppliers
- Production engineering
- Conveyor technology
- Inspection

Proportional directional control valve as final control element – dynamic and fast changing of flow rates

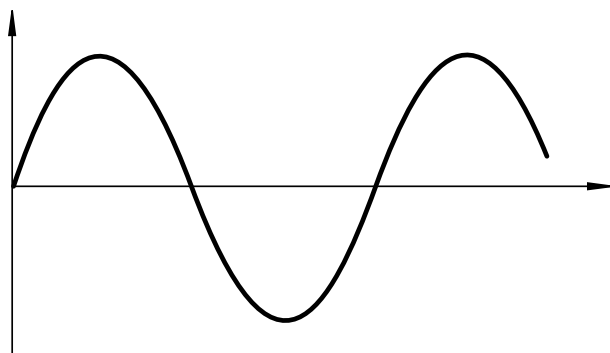

Y-axis: Cylinder speed
X-axis: Time

- Fatigue testing
- SoftStop with end-position controller SPC11

Type codes

001	Series
MPYE	Proportional directional control valve

002	Valve function
5	5/3-way valve

003	Pneumatic connection
M5	M5
1/8	G1/8
1/4	G1/4
3/8	G3/8

004	Flow rate
	Standard
HF	High flow rate
LF	Low flow rate

005	Setpoint input for individual valves
010	0 ... 10 V
420	4 ... 20 mA

006	Generation
B	Series B

Peripherals overview

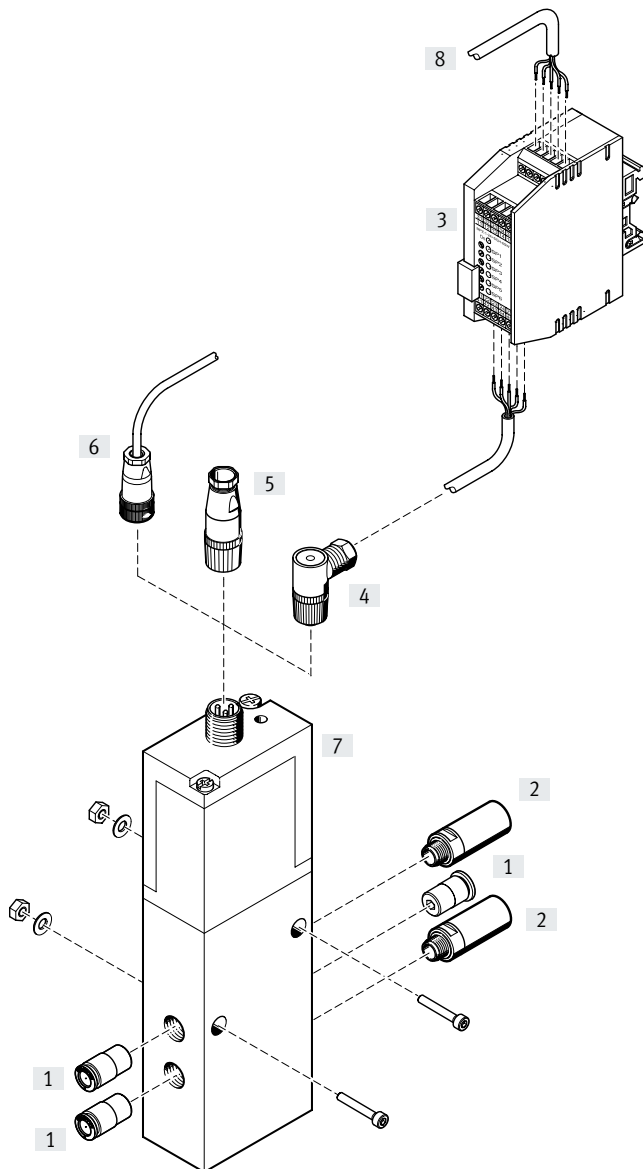

Accessories		Description	→ Page/Internet
[1]	Push-in fitting	For connecting compressed air tubing with standard O.D.	npqh
[2]	Silencer U	For mounting in exhaust ports	u
[3]	Setpoint module MPZ	For generating 6+1 analogue voltage signals	10
[4]	Sensor socket SIE-WD-TR	Angled, 4-pin, M12x1	10
[5]	Sensor socket SIE-GD	Straight, 4-pin, M12x1	10
[6]	Connecting cable KMPYE	–	10
[7]	Proportional directional control valve MPYE	–	6
[8]	Digital input/output	For actuating the setpoint module	–

Data sheet

Function

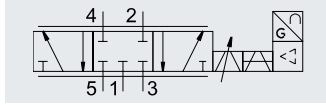

Variants

- Setpoint input as analogue voltage signal 0 ... 10 V
- Setpoint input as analogue current signal 4 ... 20 mA

- Voltage
17 ... 30 V DC
- Flow rate
100 ... 2000 l/min
- Pressure
0 ... 1 MPa
0 ... 10 bar



General technical data		Pneumatic connection		G1/8		G1/4		G3/8	
		M5		Low flow rate	High flow rate				
Valve function		5/3-way, normally closed							
Design		Piston spool, directly actuated, controlled piston spool position							
Sealing principle		Hard							
Actuation type		Electrical							
Reset method		Magnetic							
Type of control		Direct							
Direction of flow		Not reversible							
Type of mounting		Via through-hole							
Mounting position ¹⁾		Any							
Nominal width	[mm]	2	4	6	8	10			
Standard nominal flow rate	[l/min]	100	350	700	1400	2000			
Product weight	[g]	255	285	285	510	685			

1) If the proportional directional control valve moves during operation, it must be mounted at right angles to the direction of movement.

Flow rate q at 6 → 5 bar as a function of setpoint voltage or current

Voltage type MPYE-5-...-010-B

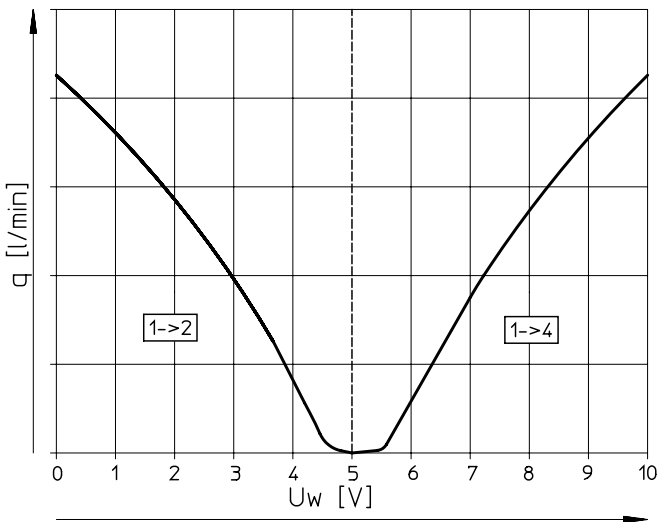

Current type MPYE-5-...-420-B

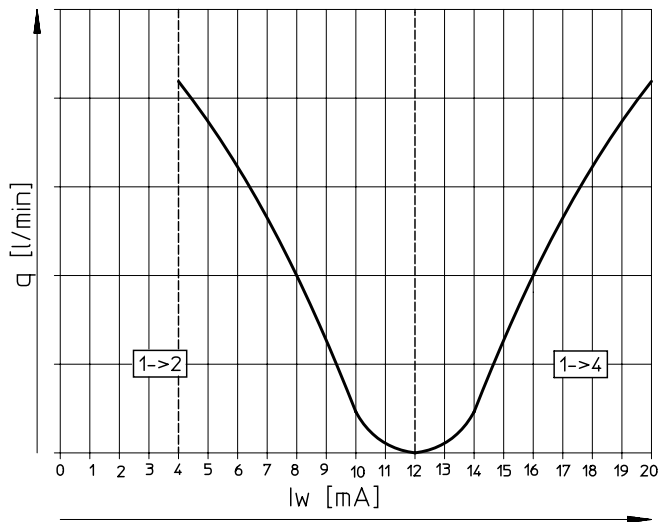

Data sheet

Electrical data						
Pneumatic connection		M5	G1/8		G1/4	G3/8
			Low flow rate	High flow rate		
Power supply	[V DC]	17 ... 30				
Switching times	[ms]	4.1	4.8		5.0	5.5
Reference value	Voltage type	[V DC]	0 ... 10			
	Current type	[mA]	4 ... 20			
Max. hysteresis ¹⁾	[%]	0.4				
Valve mid-position	Voltage type	[V DC]	5 (±0.1)			
	Current type	[mA]	12 (±0.16)			
Duty cycle ²⁾	[%]	100				
Residual ripple	[%]	5				
Critical frequency ³⁾	[Hz]	115	95	95	80	70
Reverse-polarity protection	Voltage type	For all electrical connections				
	Current type	For setpoint value				
Degree of protection		IP65				
Electrical connection		4-pin plug, round design, M12x1				

1) Based on the maximum stroke of the piston spool.

2) The proportional directional control valve switches off automatically if it overheats (goes to mid-position) and switches back on once cool.

3) Corresponds to the 3dB corner frequency at the maximum movement stroke of the piston spool.

Operating and environmental conditions

Operating pressure	[MPa]	0 ... 1				
	[bar]	0 ... 10				
Operating medium		Compressed air to ISO 8573-1:2010 [6:4:4]				
Note on the operating/pilot medium		Lubricated operation not possible				
Ambient temperature	[°C]	0 ... 50				
Temperature of medium	[°C]	5 ... 40, condensation not permitted				
Certification		RCM				
Shock and vibration resistance ¹⁾		To DIN/IEC 68 Parts 2 – 27, severity level 2 to FN 942017 Parts 4 and 5				
CE marking (see declaration of conformity) ²⁾		To EU EMC Directive ³⁾				
		To EU RoHS Directive				
UKCA marking (see declaration of conformity) ²⁾		To UK instructions for EMC ³⁾				
		To UK RoHS instructions				
KC mark		KC EMC				
Corrosion resistance CRC ⁴⁾		2				
Note on materials		RoHS-compliant				
PWIS conformity		VDMA24364-B2-L				

1) If the proportional directional control valve moves during operation, it must be mounted at right angles to the direction of movement.

2) Additional information www.festo.com/catalogue/... → Support/Downloads.

3) For information about the area of use, see the EC declaration of conformity at: www.festo.com/catalogue/... → Support/Downloads.

If the devices are subject to usage restrictions in residential, commercial or light-industrial environments, further measures for the reduction of the emitted interference may be necessary.

4) Corrosion resistance class CRC 2 to Festo standard FN 940070

Moderate corrosion stress. Indoor applications in which condensation can occur. External visible parts with primarily decorative surface requirements which are in direct contact with a normal industrial environment.

Data sheet

Materials

Sectional view

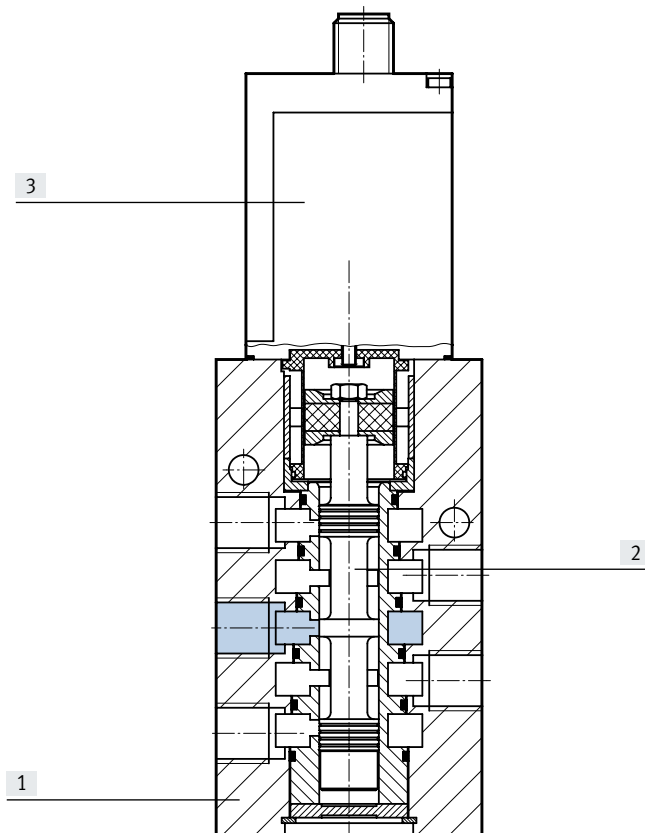

 **Note**
If the power supply cable breaks, the valve assumes the closed mid-position.

Proportional directional control valve

[1]	Housing	Anodised aluminium
[2]	Valve spool	Tempered aluminium
[3]	Housing for electronics	Coated ABS
-	Seals	NBR

Data sheet

Dimensions

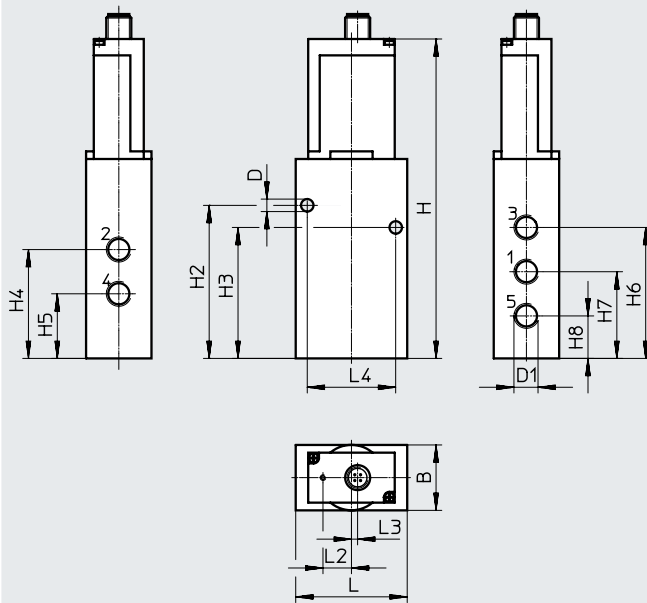
 Download CAD data → www.festo.com

Type	Pneum. connection D1	B	D ∅	H	H2	H3	H4
MPYE-5-M5-...-B	M5	26	5.5	130	57	39	32.3
MPYE-5-1/8-...-B	G1/8	26	5.5	149.3	71.3	55.3	45.8
MPYE-5-1/4-...-B	G1/4	35	6.5	162.5	77.5	66	54.5
MPYE-5-3/8-...-B	G3/8	40	6.5	174.5	96.3	77.3	63.3

Type	Pneum. connection D1	H5	H6	H7	H8	L	L2	L3	L4
MPYE-5-M5-...-B	M5	20.3	38.3	26.3	14.3	45	14.8	3.2	32
MPYE-5-1/8-...-B	G1/8	26.8	55.3	36.3	17.3	45	14.8	3.2	35
MPYE-5-1/4-...-B	G1/4	31.5	66	43	20	58	14.8	3.2	46
MPYE-5-3/8-...-B	G3/8	35.3	80.3	49.3	18.3	67	14.8	3.2	54

Terminal allocation

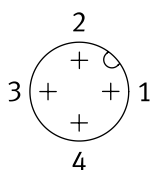

- 1 24 V DC, supply voltage
- 2 GND
- 3 U_w/I_w , setpoint input
- 4 GND

Ordering data

Description	Part no.	Type	
Proportional directional control valves MPYE			
Data sheets → Internet:mpye			
Voltage type 0 ... 10 V Current type 4 ... 20 mA	Pneumatic connection M5	Standard flow rate 154200 MPYE-5-M5-010-B	
	Pneumatic connection G1/8	Low flow rate 151692 MPYE-5-1/8-LF-010-B	
		High flow rate 151693 MPYE-5-1/8-HF-010-B	
	Pneumatic connection G1/4	Standard flow rate 151694 MPYE-5-1/4-010-B	
	Pneumatic connection G3/8	Standard flow rate 151695 MPYE-5-3/8-010-B	
	Pneumatic connection M5	Standard flow rate 162959 MPYE-5-M5-420-B	
		Pneumatic connection G1/8	Low flow rate 161978 MPYE-5-1/8-LF-420-B
			High flow rate 161979 MPYE-5-1/8-HF-420-B
		Pneumatic connection G1/4	Standard flow rate 161980 MPYE-5-1/4-420-B
		Pneumatic connection G3/8	Standard flow rate 161981 MPYE-5-3/8-420-B

Accessories

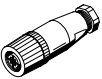
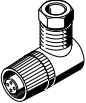
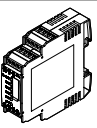
Ordering data	Description	Part no.	Type
Connecting cable Data sheets → Internet: connecting cable			
	Straight socket, M12x1, 4-pin, open cable end	Cable length 5 m	151909 KMPYE-5
Sensor socket Data sheets → Internet: sie			
	Straight, 4-pin, M12x1	18494	SIE-GD
	Angled, 4-pin, M12x1	12956	SIE-WD-TR
Setpoint module Data sheets → Internet: mpz			
	Setpoint module for generating 6 + 1 analogue voltage signals	546224	MPZ-1-24DC-SGH-6-SW