

Position transmitters SMAT-8M, for T-slot

FESTO

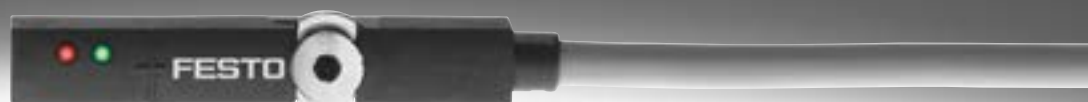

Key features

Design

General

The SMAT-8M is a position transmitter for the contactless sensing of the piston position of drives that can be detected magnetically.

It supplies a displacement-proportional analogue output signal in the position measuring range. It is connected directly to analogue PLC inputs without any accessories.

With its extremely compact design, the SMAT-8M is the ideal solution for grippers, short-stroke cylinders and all applications in which installation space is restricted.

Note
It can be used with Festo drives with T-slot (profile slot 8) as well as round cylinders and tie-rod cylinders with mounting kits. See Support Portal "The right sensor for the actuator".

Position measuring range

The SMAT-8M supplies a displacement-proportional analogue output signal of 0 ... 10 V in a position measuring range of up to 52 mm (depending on the drive used).

As a visual aid, the green LED lights up within the position measuring range (B) and the red LED lights up outside of the measuring range (A)/(C) in normal operation.

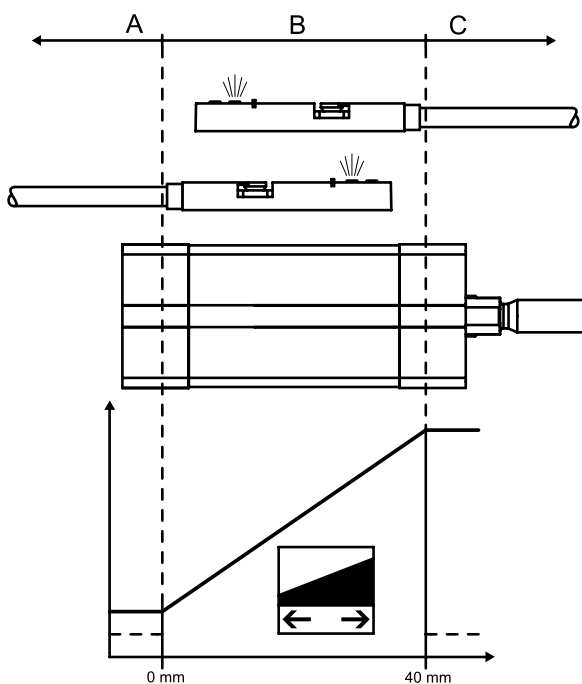

Peripherals overview

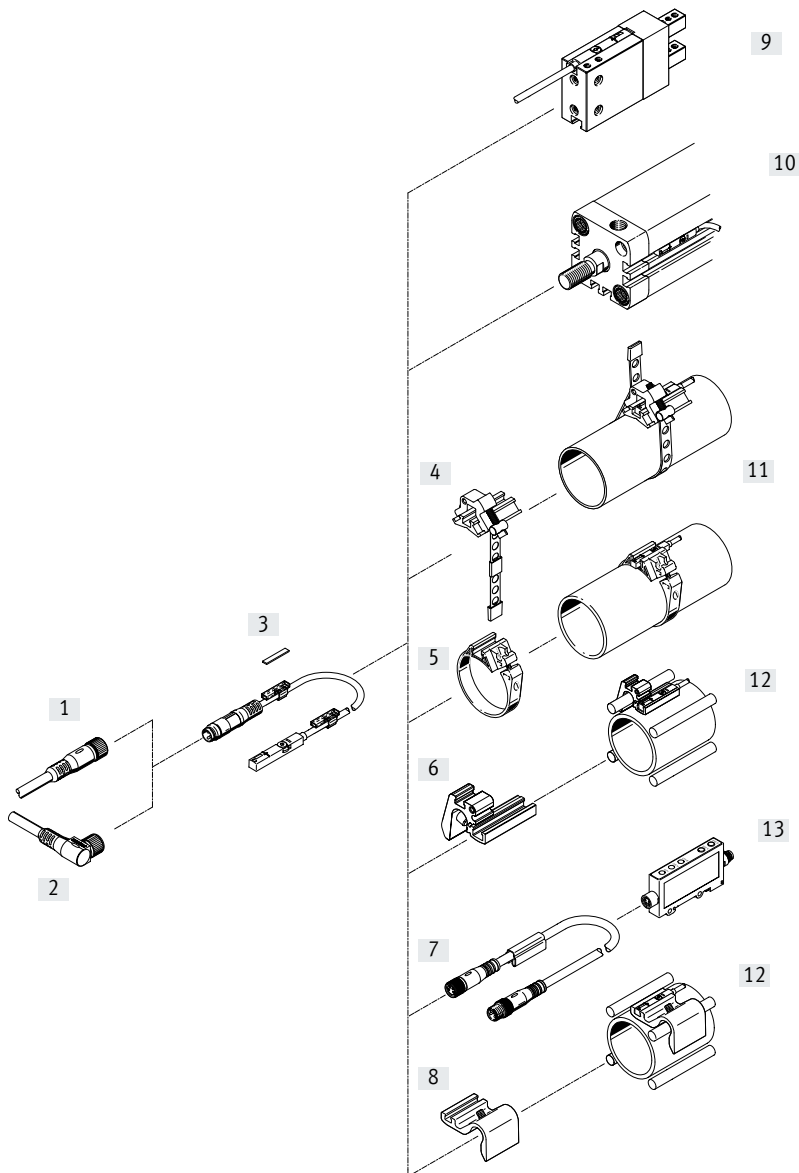

Accessories	→ Page/ Internet	Accessories	→ Page/ Internet
[1] Connecting cable NEBU-M8G4	10	[10] Standards-based cylinder DSBC	dsbc
[2] Connecting cable NEBU-M8W4	10	Standards-based cylinder DNC	dnc
[3] Inscription label ASLR	10	Compact cylinder ADN	adn
[4] Mounting kit SMBR-8-8/100-S6, heat resistant	10	Short-stroke cylinder ADVC/AEVC	advc
[5] Mounting kit SMBR	10	Compact cylinder ADVU/AEUV	advu
[6] Mounting SMBZ-8	10	Flat cylinder DZF	dzf
[7] Connecting cable NEBU-M8G4	10	Linear drive DGC	dgc
[8] Sensor bracket DASP-M4-...	10	Linear/swivel clamp CLR	clr
[9] Three-point gripper DHDS	dhds	Guided drive DFM	dfm
Three-point gripper HGDD	hgdd	[11] Standards-based/round cylinder DSNU	dsnu
Parallel gripper DHPS	dhps	Linear drive unit SLE	sle
Parallel gripper HGPD	hgpd	[12] Standards-based cylinder DSBG	dsbg
Parallel gripper HGPT	hgpt	[13] Signal converter SVE4	sve4
Angle gripper DHWS	dhws		
Radial gripper DHRS	dhrs		
Radial gripper HGRT	hgrt		

Type codes

001	Series
SMAT	Position transmitter, magnetic

002	Design type
8	For T-slot

003	Sensor version
M	Inserted in the slot from above

004	Analogue output
U	0 ... 10 V

005	Cable characteristic
E	Suitable for energy chains/robot applications

006	Cable length [m]
0,3	0.3 m

007	Electrical connection
M8D	Plug M8, 4-pin, rotatable thread

Data sheet

Function

Normal operation

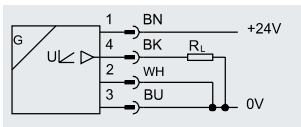

General technical data	
Design	For T-slot
Mounting position	Any
Certification	c UL us listed (OL) RCM
CE marking (see declaration of conformity)	To EU EMC Directive ¹⁾ To EU RoHS Directive
UKCA marking (see declaration of conformity)	To UK instructions for EMC To UK RoHS instructions
KC mark	KC EMC
Certificate issuing authority	UL E232949
Application information	Support / Overview of actuator sensors „The right sensor for the actuator“
Note on materials	RoHS-compliant Halogen-free
PWIS conformity	VDMA24364-B2-L

- 1) For information about the area of use, see the EC declaration of conformity at: www.festo.com/catalogue/SMAT-8M → Support/Downloads.
If the devices are subject to usage restrictions in residential, commercial or light-industrial environments, further measures for the reduction of the emitted interference may be necessary.

Input signal/measuring element	
Measured variable	Position
Measuring principle	Magnetic
Position measuring range [mm]	≤ 52 ²⁾

- 2) Dependent on drive/gripper used, see application information.

Signal processing	
Max. speed of travel [m/s]	3

Output, general	
Path resolution [mm]	≤ 0.02
Repetition accuracy [mm]	0.2

Analogue output	
Typical linearity error [mm]	±1

Electrical outputs	
Analogue output [V]	0 ... 10
Short circuit current rating	Yes
Overload protection	Available
Output signal	Analogue

Data sheet

Electronics		
Operating voltage range	[V DC]	15 ... 30
No-load supply current	[mA]	< 12
Typical sampling interval	[ms]	2
Residual ripple	[%]	10
Reverse polarity protection		For all electrical connections
Electromechanics		
Electrical connection		SMAT-8M-U-E-0,3-M8D
Connection direction		In-line
Connection type		Cable with plug
Connection technology		M8x1, A-coded to EN 61076-2-104
Number of pins/wires		4
Type of mounting		Screw-type lock
Cable length	[m]	0.3
Cable characteristic		Suitable for energy chains + robot applications
Cable test conditions		Energy chain: 5 million cycles, bending radius 28 mm
		Torsional resistance: > 300,000 cycles, $\pm 270^\circ/0.1$ m
		Resistance to bending: to Festo standard; test conditions on request
Housing material		High-alloy stainless steel, PA reinforced
Union nut material		Nickel-plated brass
Cable sheath material		TPE-U (PUR)
Material of pin contacts		Gold-plated copper alloy
Cable sheath colour		Grey
Mechanics		
Type of mounting		Screw-clamped, inserted in the slot from above
Product weight	[g]	9.5
Display/operation		
Status indication		Red, green LED
Immission/emission		
Ambient temperature	[°C]	-40 ... +80
Ambient temperature with flexible cable installation	[°C]	-20 ... +70
Degree of protection		IP65, IP68
Corrosion resistance class CRC ¹⁾		2

1) Corrosion resistance class CRC 2 to Festo standard FN 940070

Moderate corrosion stress. Indoor applications in which condensation can occur. External visible parts with primarily decorative surface requirements which are in direct contact with a normal industrial environment.

Data sheet

Terminal allocation

Normal operation

Plug

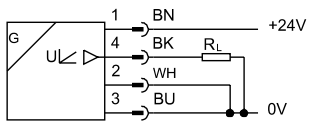

- 1 Operating voltage
- 2 Analogue output 0 V
- 3 0 V
- 4 Analogue output 0 ... 10 V

Wire colours

BN = Brown
BK = Black

BU = Blue
WH = White

Dimensions

Download CAD data → www.festo.com

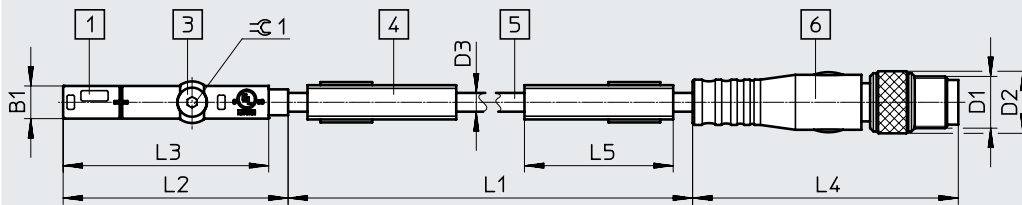
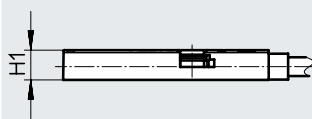







- [1] Light emitting diode
- [3] Clamping element
- [4] Inscription label holder
- [5] Connecting cable
- [6] Plug M8, 4-pin, rotatable thread

B1	D1	D2 ∅	D3 ∅	H1	L1	L2	L3	L4	L5	⊕
5	M8x1	9.6	2.9	4.6	300	34.8	31.8	41.1	23	1.5

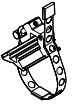
Ordering data

Size	Analogue output [V]	Electrical connection	Cable length [m]	Part no.	Type
	0 ... 10	Plug M8, 4-pin, rotatable thread	0.3	553744	SMAT-8M-U-E-0.3-M8D

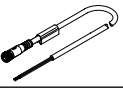
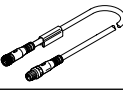
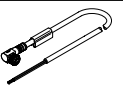
Accessories

Ordering data – Mounting components						
	For piston \varnothing	Part no.	Type			
Mounting kit SMBR-8-8/100-S6, heat-resistant						
	8 ... 100	538937	SMBR-8-8/100-S6			
Mounting kit SMBR						
	8	175091	SMBR-8-8			
	10	175092	SMBR-8-10			
	12	175093	SMBR-8-12			
	16	175094	SMBR-8-16			
	20	175095	SMBR-8-20			
	25	175096	SMBR-8-25			
	32	175097	SMBR-8-32			
	40	175098	SMBR-8-40			
	50	175099	SMBR-8-50			
63	175100	SMBR-8-63				
Mounting SMBZ						
	32 ... 100	537806	SMBZ-8-32/100			
	125 ... 320	537808	SMBZ-8-125/320			
Sensor bracket DASP-M4-...						
	For DSBG-125	1451483	DASP-M4-125-A			
	For DSBG-250	1456781	DASP-M4-250-A			
	For DSBG-320	3015256	DASP-M4-320-A			
Ordering data – Connecting cable NEBU-M8						
	Electrical connection, left	Electrical connection, right	Cable length [m]	Part no.	Type	Data sheets → Internet: nebu
	Straight socket, M8x1, 4-pin	Cable, open end, 4-wire	2.5	541342	NEBU-M8G4-K-2.5-LE4	
			5	541343	NEBU-M8G4-K-5-LE4	
	Straight socket, M8x1, 4-pin	Straight socket, M8x1, 4-pin	2.5	554035	NEBU-M8G4-K-2.5-M8G4	
	Angled socket, M8x1, 4-pin	Cable, open end, 4-wire	2.5	541344	NEBU-M8W4-K-2.5-LE4	
			5	541345	NEBU-M8W4-K-5-LE4	
Ordering data – Inscription label ASLR						
	Size	Part no.	Type	PU ¹⁾		
	23x4 mm	541598	ASLR-L-423	34		

1) Packaging unit per frame