

Diese Zeichnung ist Eigentum der Festo Didactic SE
This drawing is the property of Festo Didactic SE



Schaltungsunterlagen Circuit diagrams

Bezeichnung: SkillsConveyor
 designation:

Kunde:
 Customer:

Anlagenkennzeichen G1 SkillsConveyor
 Plant identifier

Variante
 variant Skills Bandsteuerung

Bemerkung: Schaltschrank Control cabinet
 remark:

letzte Änderung: 2023-04-12
 last Modification:

Druckdatum: 2023-04-12
 Print date:

Pfad: \\festo.net\dfs01\INT\Data\EPLAN\DATA_xx\DE\Projects\Didactic\Products\31 Skills\SkillsConveyorV2.elk
 Path:

&EAB/2>>

Date	2023-03-21	Festo Didactic SE		Titel- / Deckblatt Title page/cover sheet	Part number				
Ed. by.	Schuhmacher	Rechbergstraße 3			PSP / DPJ	VN	= G1	SkillsConveyor	Page 1
Drw.No.		N:			F:FDMD11DE	Version:2.9.4	+		of 14

Diese Zeichnung ist Eigentum der Festo Didactic SE. This drawing is the property of Festo Didactic SE.

&EAB

Inhaltsverzeichnis Table of contents

<&EAA/1

3>>

Date	2023-03-21	Festo Didactic SE Rechbergstraße 3 D-73770 Denkendorf	FESTO	Übersicht overview	Part number			
Ed. by.	Schuhmacher				PSP / DPJ	VN	= G1	SkillsConveyor
Drw.No.						+		of 14

Diese Zeichnung ist Eigentum der Festo Didactic SE. This drawing is the property of Festo Didactic SE.

+GL1

SkillsConveyor

<&EAB+/3

5>>

Date	2023-03-21	Festo Didactic SE Rechbergstraße 3 D-73770 Denkendorf	FESTO	Übersicht overview	Part number				
Ed. by.	Schuhmacher				PSP / DPJ	VN	= G1	SkillsConveyor	Page 4
Creat.	Schuhmacher						+ GL1	SkillsConveyor	of 14
Drw.No.		N:	F:	Version: 2.9.4	\\festo.net\dfs01\INT\DATA\EPLAN\DATA_xx\DE\Projects\Didactic\Products\31 Skills\SkillsConveyorV2.elk				

Diese Zeichnung ist Eigentum der Festo Didactic SE. This drawing is the property of Festo Didactic SE.

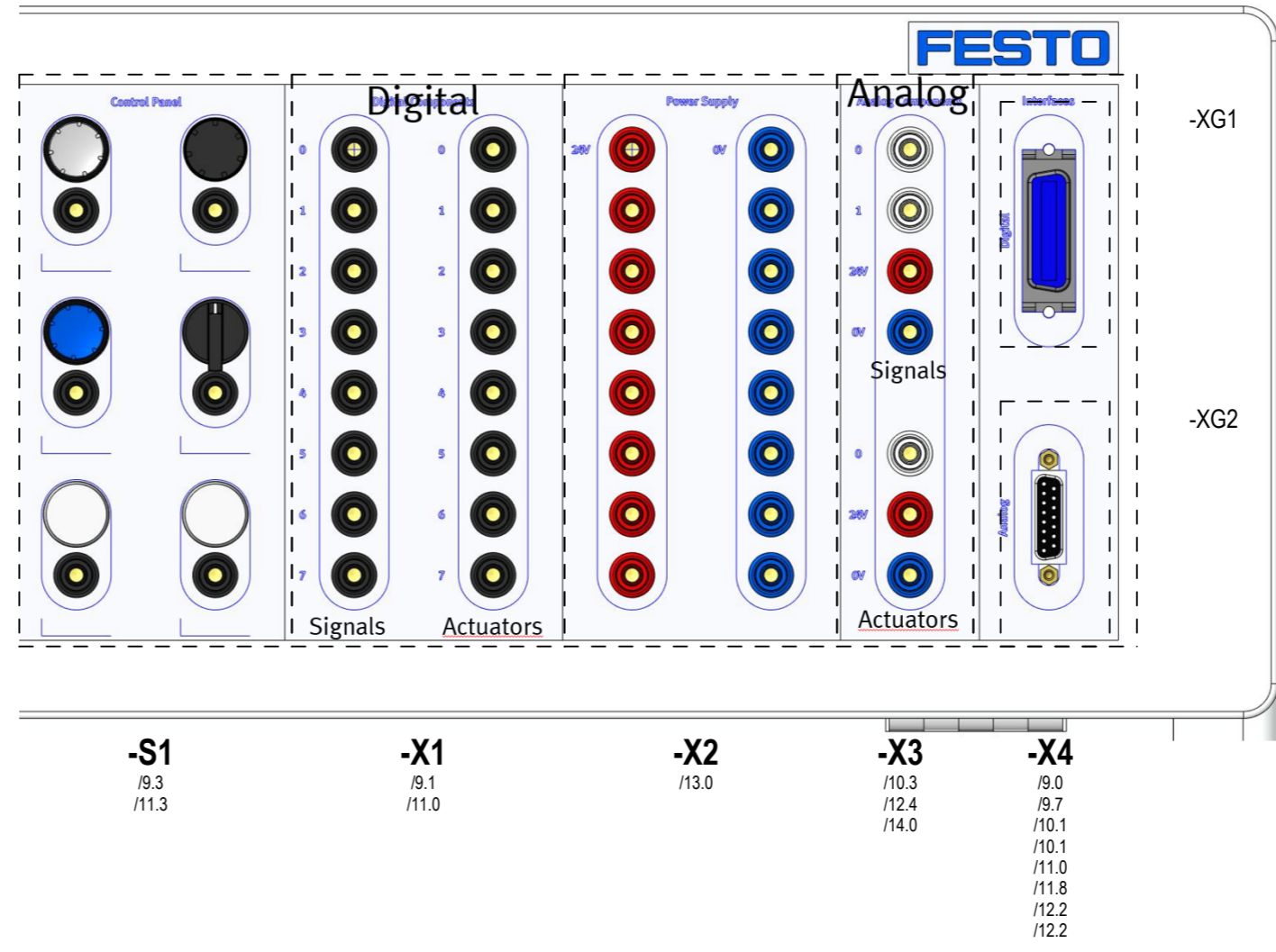

Date	2023-04-05	Festo Didactic SE Rechbergstraße 3 D-73770 Denkendorf
Ed. by.	Schuhmacher	
Creat.	Schuhmacher	
Drw.No.		N: F: Version: 2.9.4 \\festo.net\dfs01\INTData\IPLAN\DATA_xx\DE\Projects\Didactic\Products\31 Skills\SkillsConveyorV2.elk

FESTO Bedienpult Control desk

Part number			
PSP / DPJ	VN	= G1	SkillsConveyor
		+ GL1	SkillsConveyor
			Page 5 of 14

This drawing is the property of Festo Didactic SE

XG1 Digital

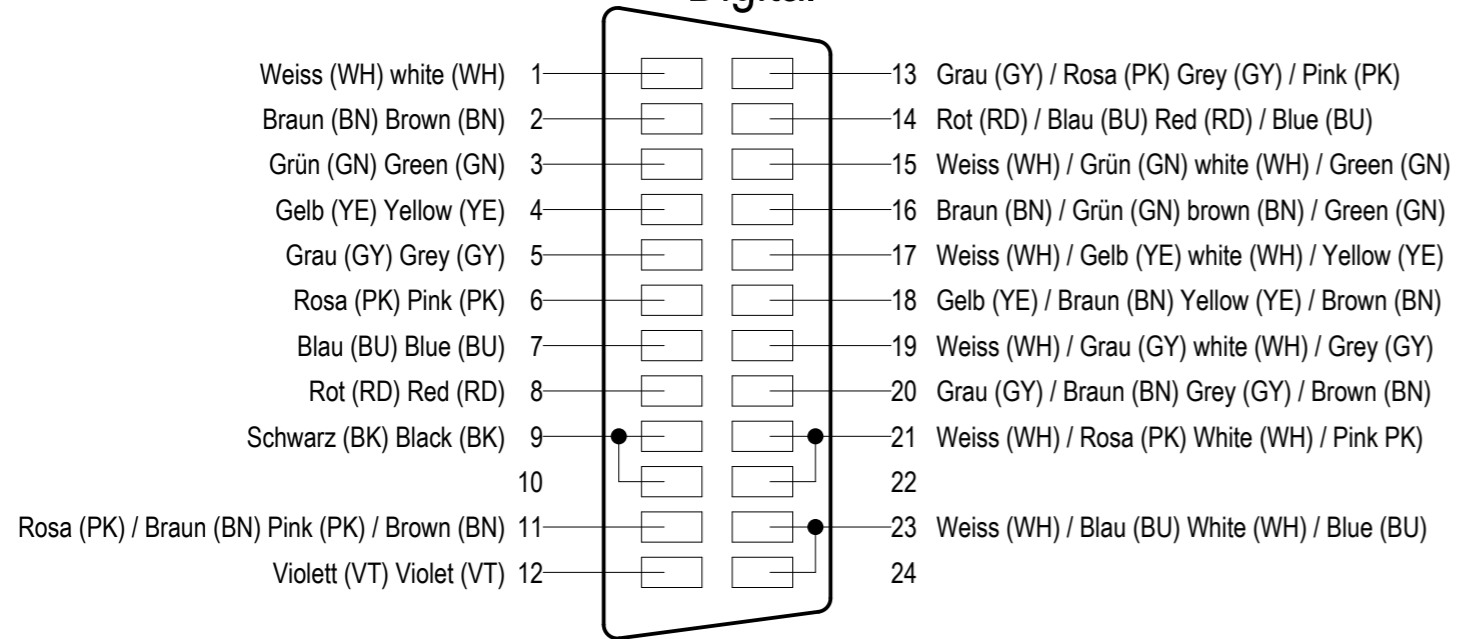

XG2 Analog

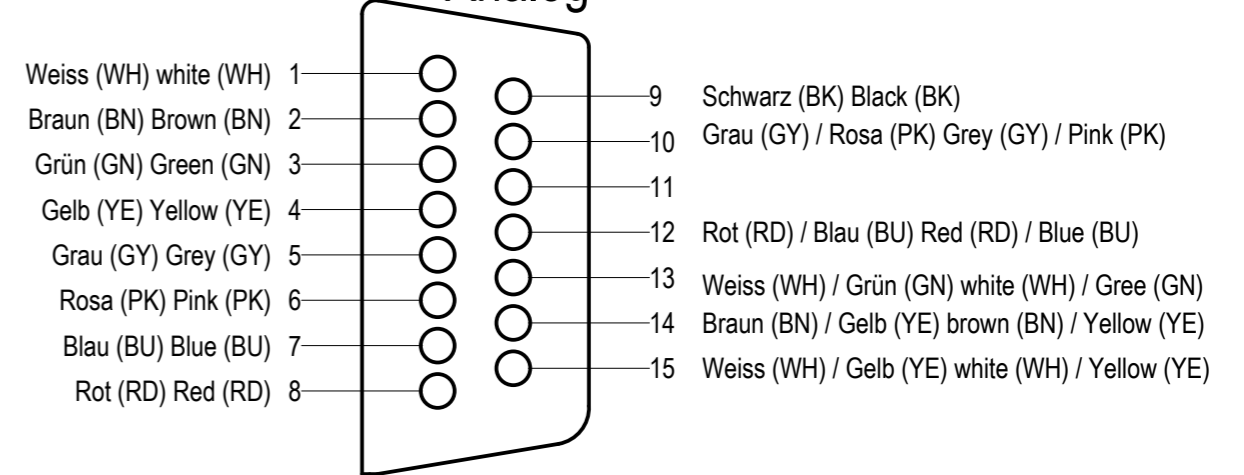

Diese Zeichnung ist Eigentum der Festo Didactic SE. This drawing is the property of Festo Didactic SE.

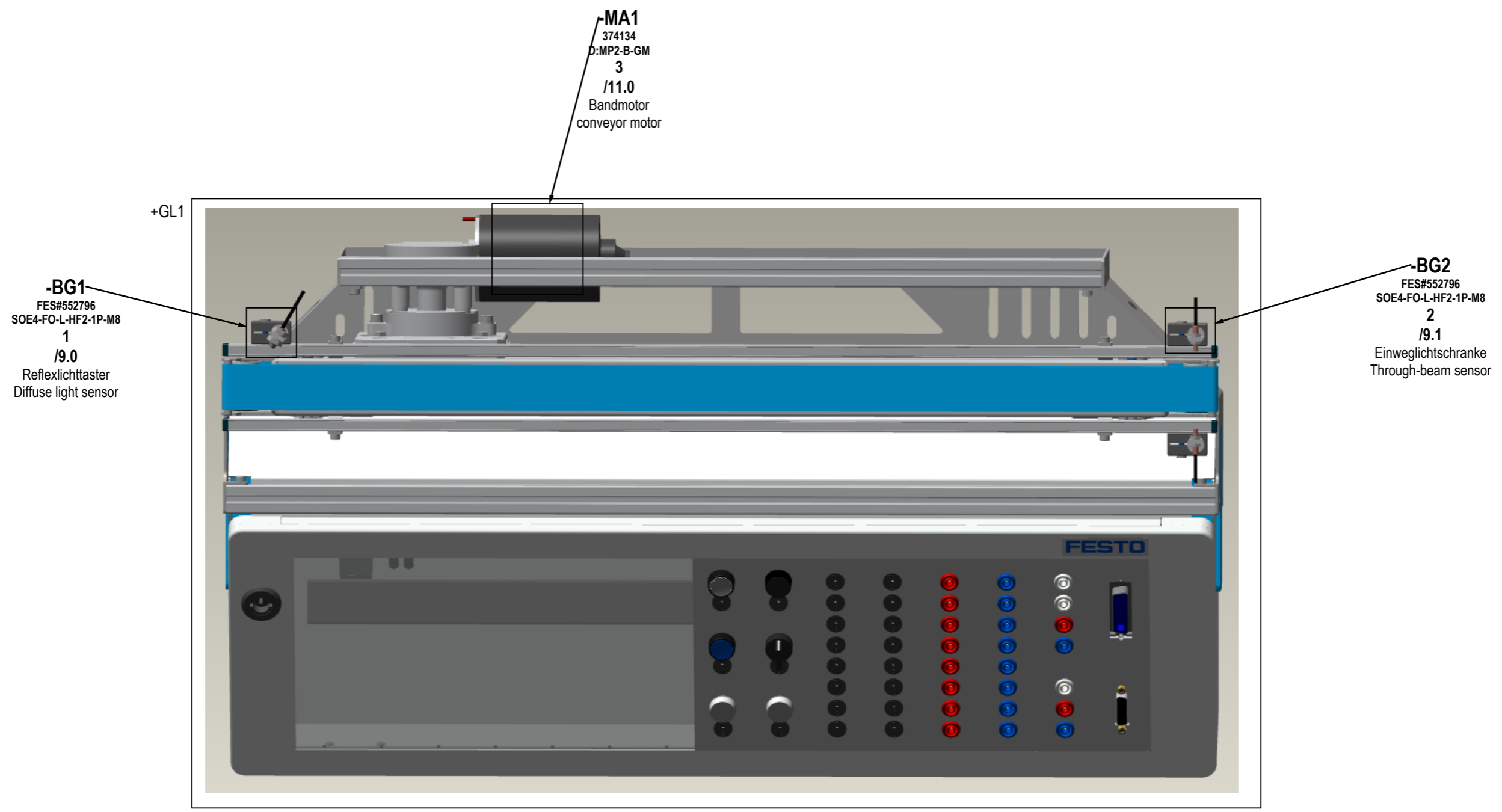

Date	2023-04-04	Festo Didactic SE Rechbergstraße 3 D-73770 Denkendorf
Ed. by.	Schuhmacher	
Creat.	Schuhmacher	
Drw.No.	N:	F:

Übersicht Overview

Part number			
PSP / DPJ	VN	= G1	SkillsConveyor
		+ GL1	SkillsConveyor
			Page 7 of 14

Diese Zeichnung ist Eigentum der Festo Didactic SE. This drawing is the property of Festo Didactic SE.

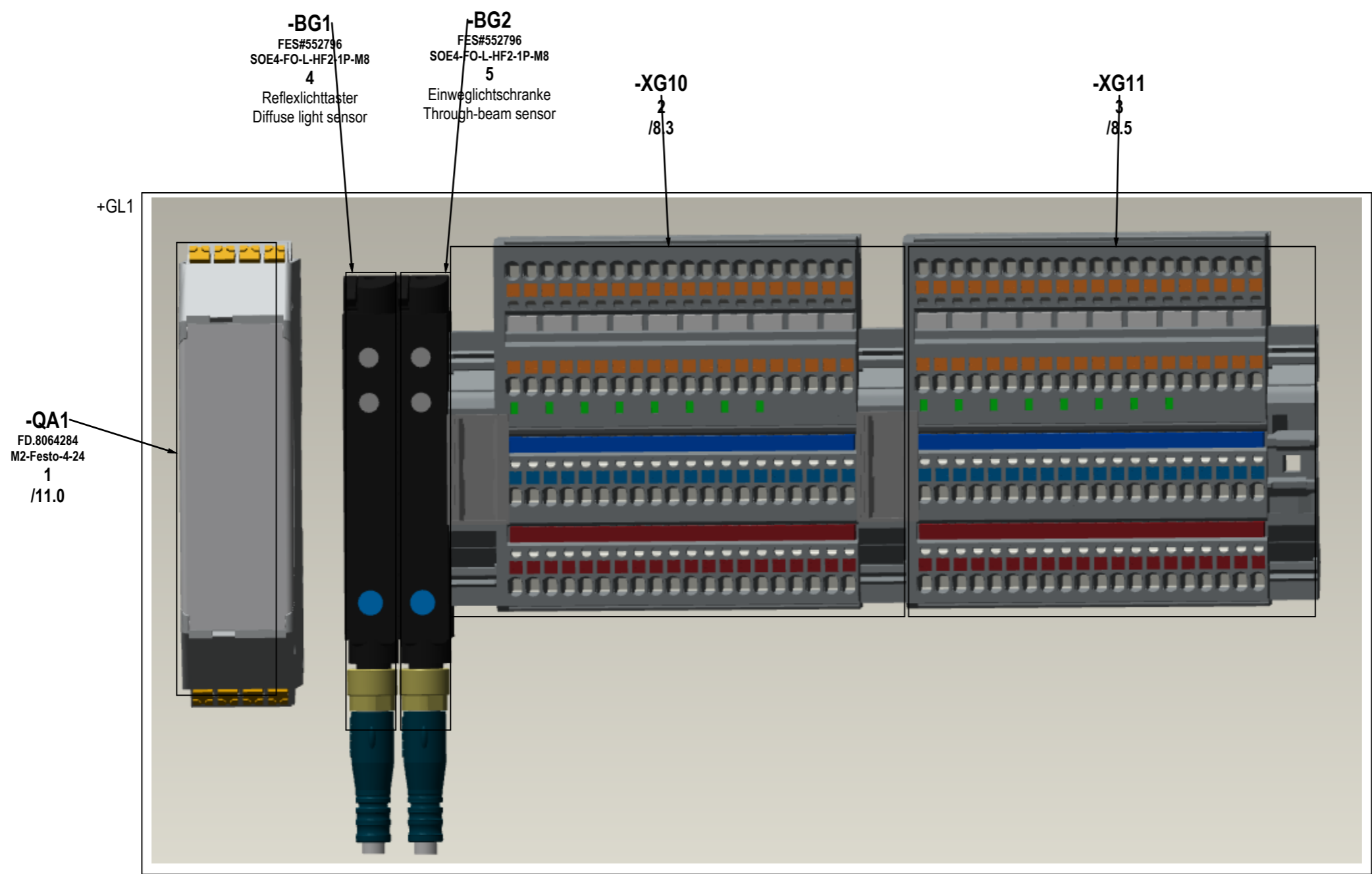

Date	2023-04-05	Festo Didactic SE
Ed. by.	Schuhmacher	Rechbergstraße 3
Creat.	Schuhmacher	D-73770 Denkendorf
Drw.No.	N:	F:

FESTO Schaltschrank Control cabinet

Part number			
PSP / DPJ	VN	= G1	SkillsConveyor
		+ GL1	SkillsConveyor
			Page 8 of 14

Diese Zeichnung ist Eigentum der Festo Didactic SE
This drawing is the property of Festo Didactic SE

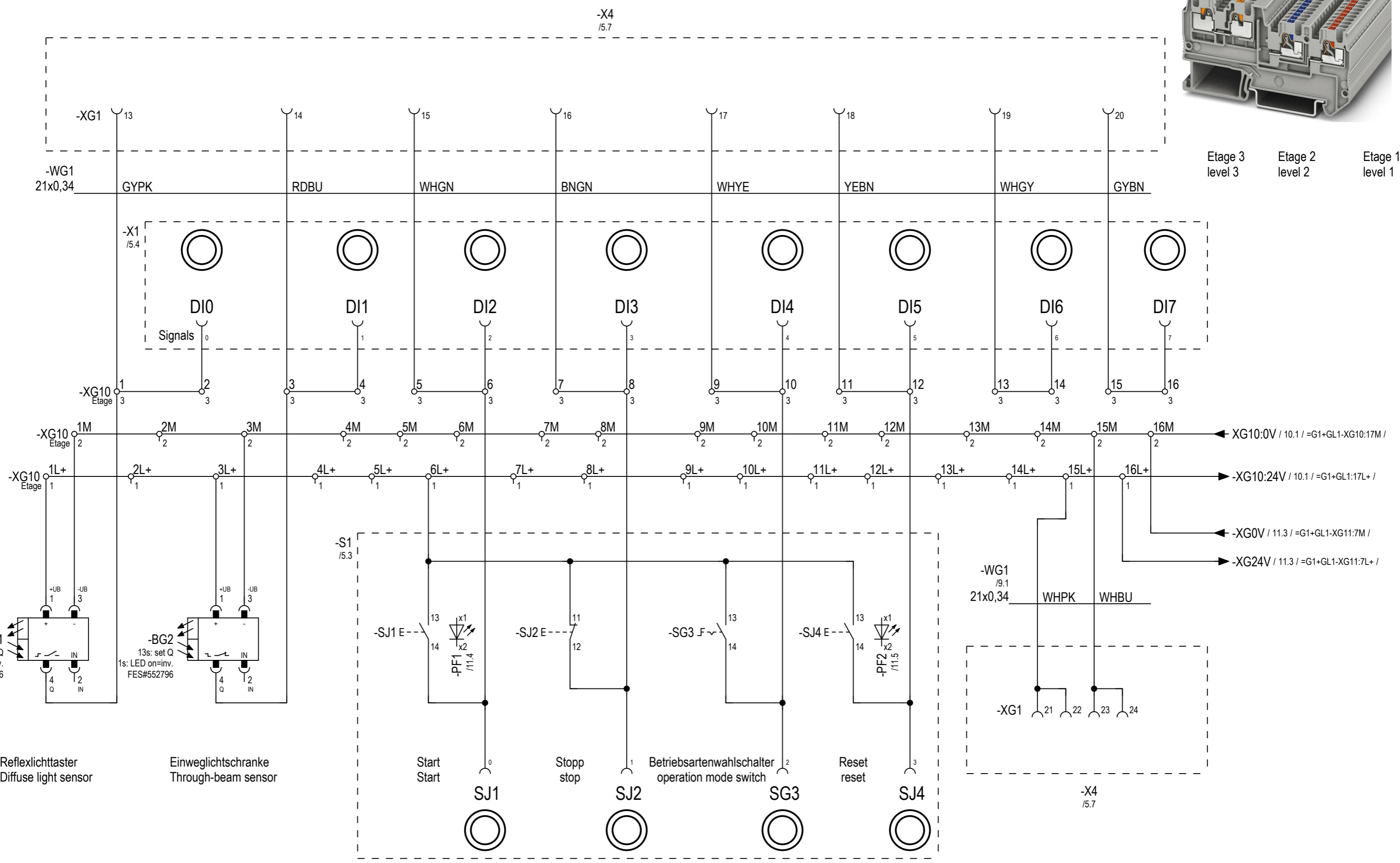
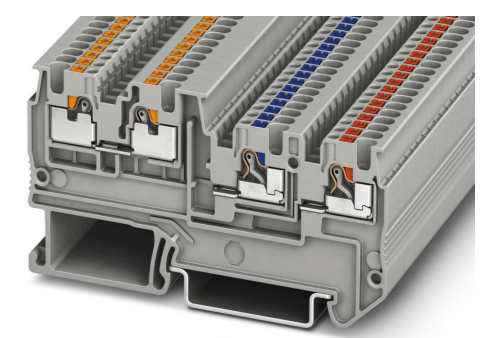

Etage 3 level 3
Etage 2 level 2
Etage 1 level 1

Date	2023-04-12	Festo Didactic SE
Ed. by.	Schuhmacher	Rechbergstraße 3
Creat.	Schuhmacher	D-73770 Denkendorf
Drw.No.	N:	F:

FESTO Digitale Eingänge digital input

Part number		
PSP / DPJ	VN	= G1 SkillsConveyor
		+ GL1 SkillsConveyor
		Page 9 of 14

Diese Zeichnung ist Eigentum der Festo Didactic SE

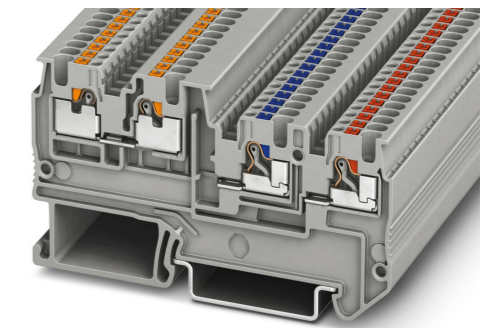
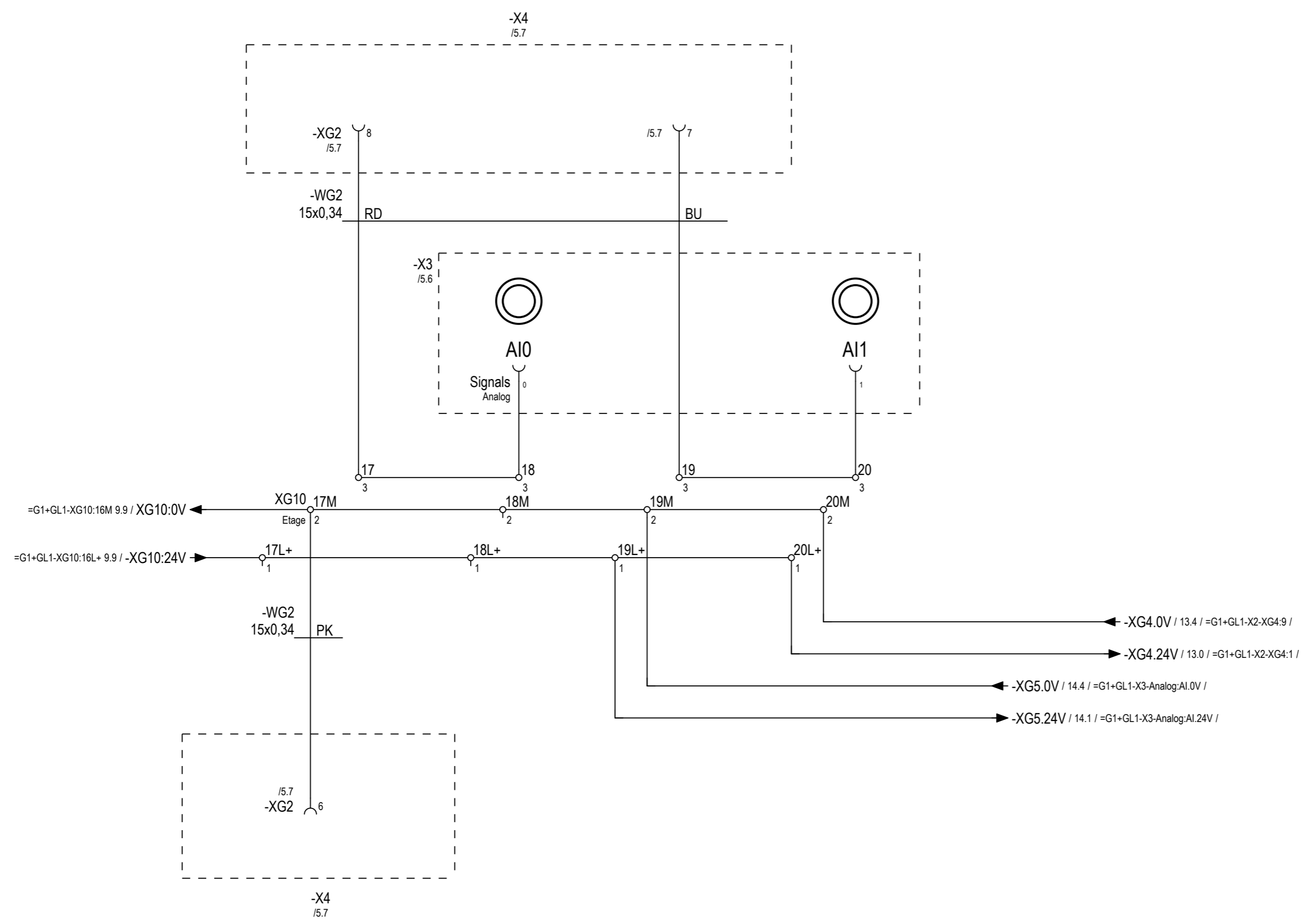

Etage 3 level 3 Etage 2 level 2 Etage 1 level 1

Date	2023-04-12	Festo Didactic SE Rechbergstraße 3 D-73770 Denkendorf
Ed. by.	Schuhmacher	
Creat.	Schuhmacher	
Drw.No.	N:	F:

FESTO Analog Eingänge analog inputs

Part number			
PSP / DPJ	VN	= G1	SkillsConveyor
		+ GL1	SkillsConveyor
			Page 10 of 14

Version: 2.9.4 \\festo.net\dfs01\INT\DATA\IEPLAN\DATA_XX\DE\Projects\Didactic\Products\31 Skills\SkillsConveyorV2.elk

Diese Zeichnung ist Eigentum der Festo Didactic SE

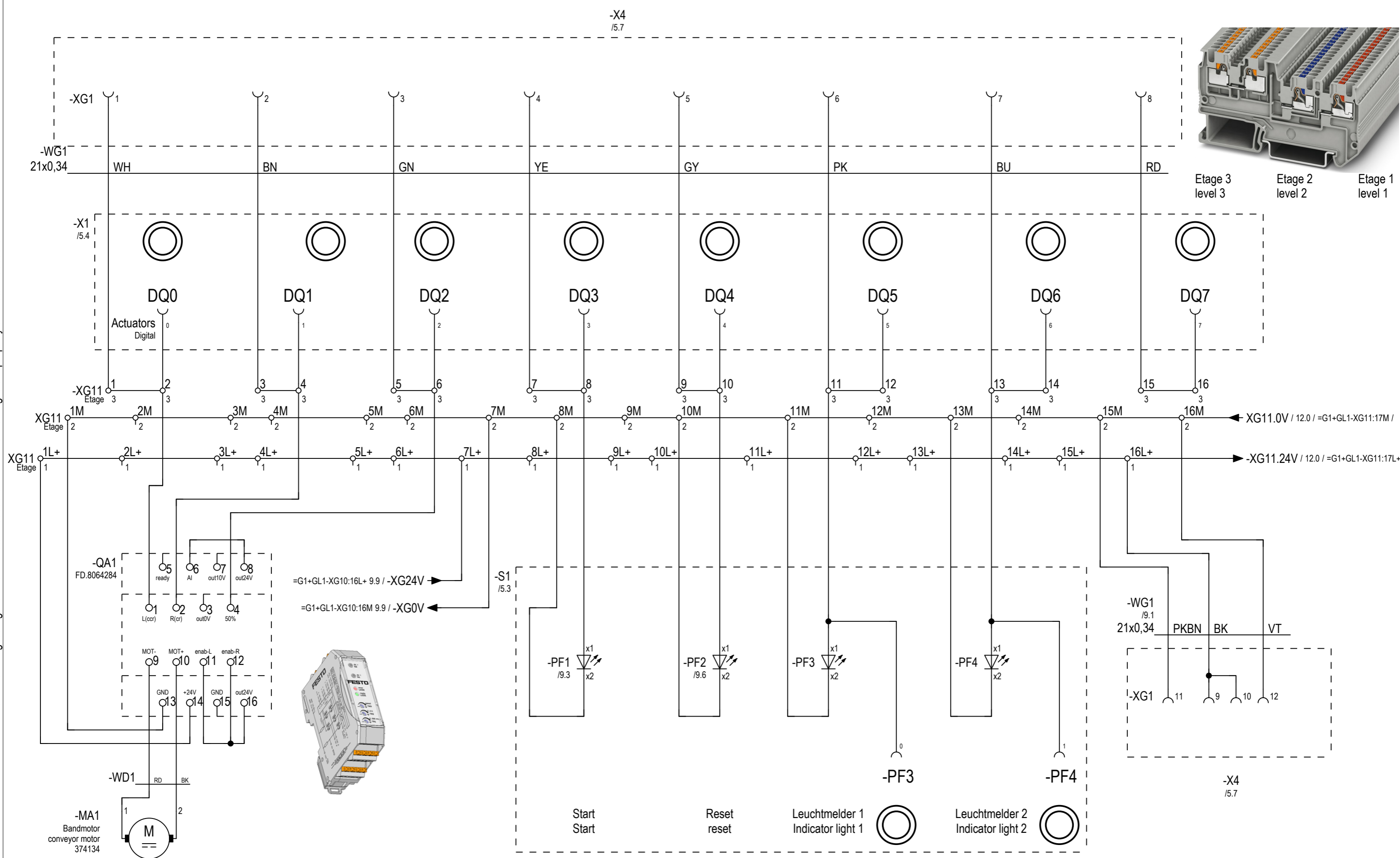

<<10

12>>

Date	2023-04-12	Festo Didactic SE Rechbergstraße 3 D-73770 Denkendorf	 Digitale Ausgänge digital output	Part number			
Ed. by.	Schuhmacher			PSP / DPJ	VN	= G1	SkillsConveyor
Drw.No.					+ GL1	SkillsConveyor	of 14

Diese Zeichnung ist Eigentum der Festo Didactic SE
This drawing is the property of Festo Didactic SE

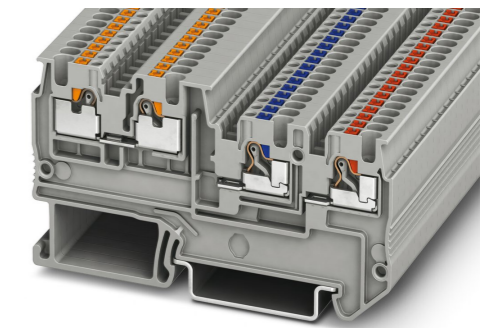
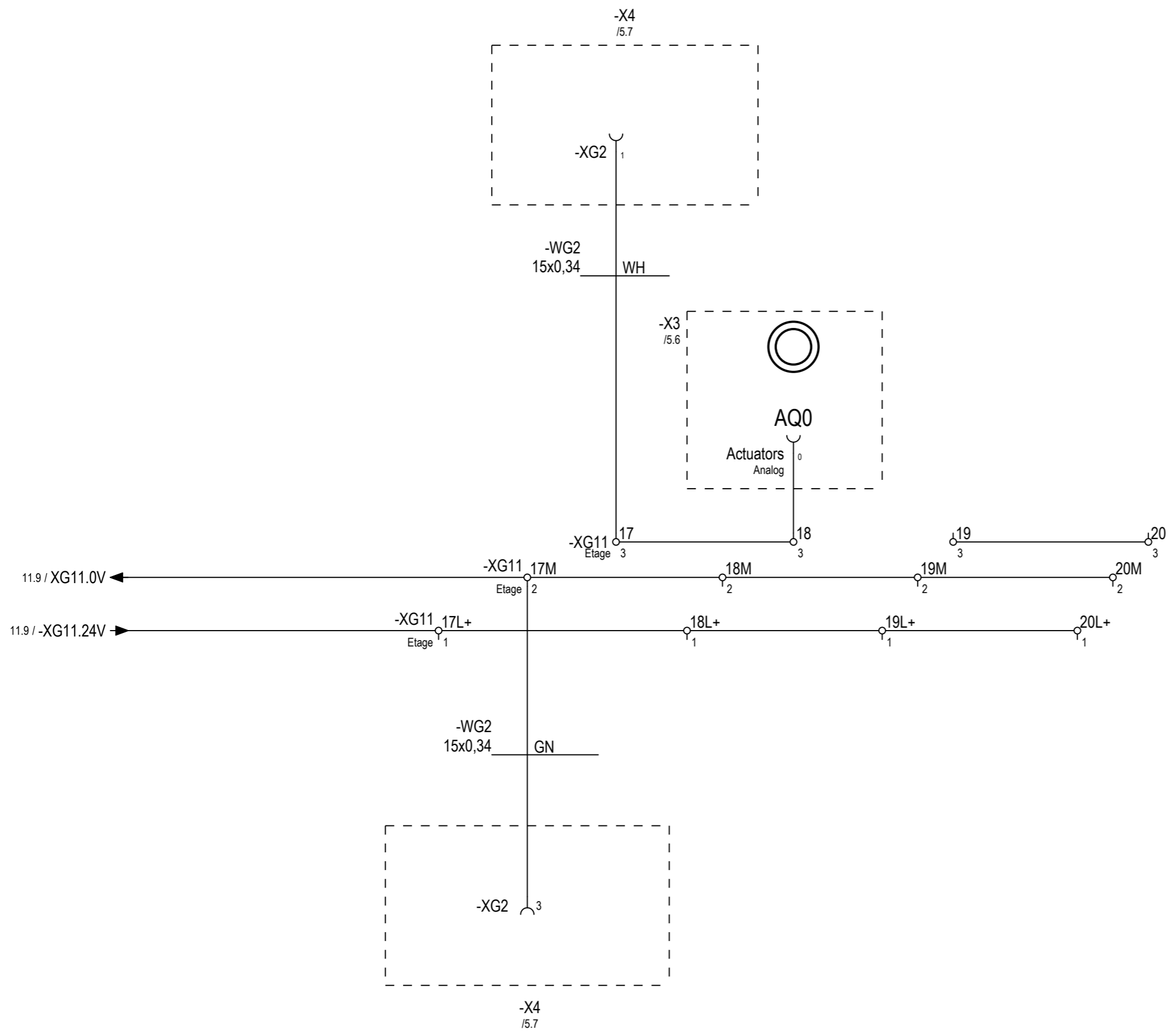

Etage 3 level 3 Etage 2 level 2 Etage 1 level 1

<<1

13>>

Date	2023-04-12	FESTO Analog Ausgänge analog output	Part number	
Ed. by.	Schuhmacher		PSP / DPJ	VN
Creat.	Schuhmacher		= G1	SkillsConveyor
Drw.No.			+ GL1	SkillsConveyor of 14

Festo Didactic SE
Rechbergstraße 3
D-73770 Denkendorf

Version: 2.9.4
\\festo.net\dfs01\INTData\PLAN\DATA_xx\IDE\Projects\Didactic\Products\31 Skills\SkillsConveyorV2.elk

Diese Zeichnung ist Eigentum der Festo Didactic SE. This drawing is the property of Festo Didactic SE.

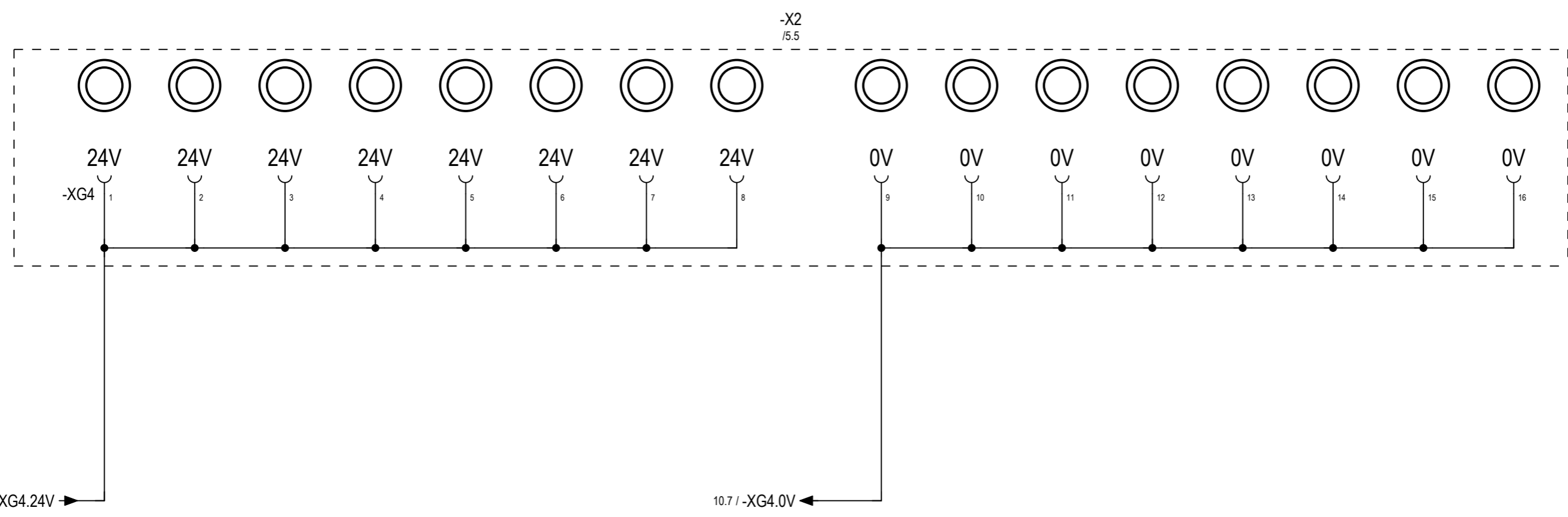

<<12

14 >>

Date	2023-04-05	Festo Didactic SE Rechbergstraße 3 D-73770 Denkendorf
Ed. by.	Schuhmacher	
Creat.	Schuhmacher	
Drw.No.		

FESTO	Spannungsversorgung Power supply

PSP / DPJ	VN	= G1	SkillsConveyor	Page 13
		+ GL1	SkillsConveyor	of 14

Diese Zeichnung ist Eigentum der Festo Didactic SE This drawing is the property of Festo Didactic SE

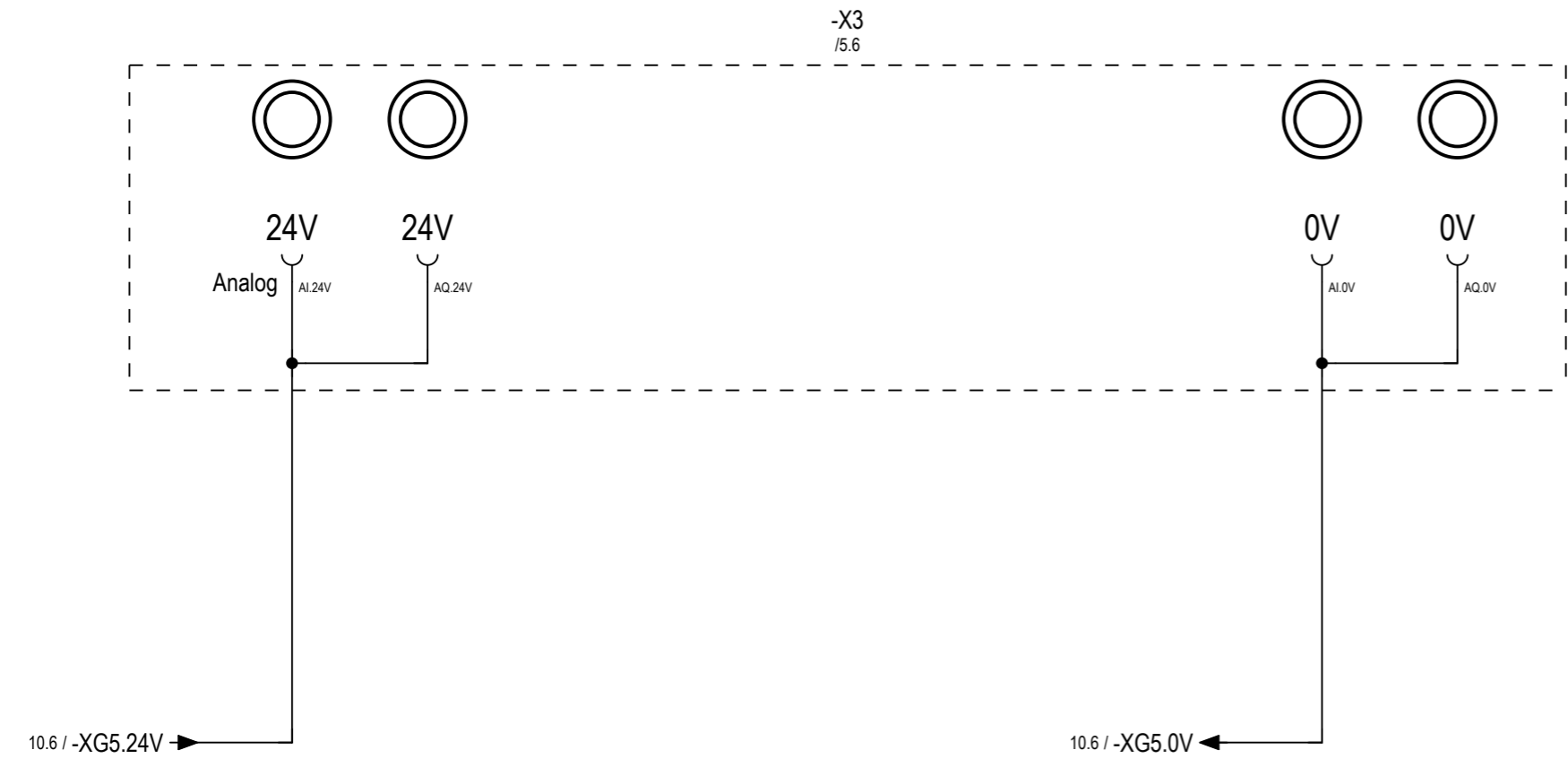

<<13

>>

Date	2023-04-05	Festo Didactic SE	
Ed. by.	Schuhmacher	Rechbergstraße 3	
Creat.	Schuhmacher	D-73770 Denkendorf	
Drw.No.		N:	F:
		Version: 2.9.4	\\festo.net\dfs01\INT\DATA\EPLAN\DATA_xx\DE\Projects\Didactic\Products\31 Skills\SkillsConveyorV2.elk



Spannungsversorgung Power supply

Part number	
PSP / DPJ	VN

= G1	SkillsConveyor	Page 14
+ GL1	SkillsConveyor	of 14