

Modular electrical terminal CPX

FESTO

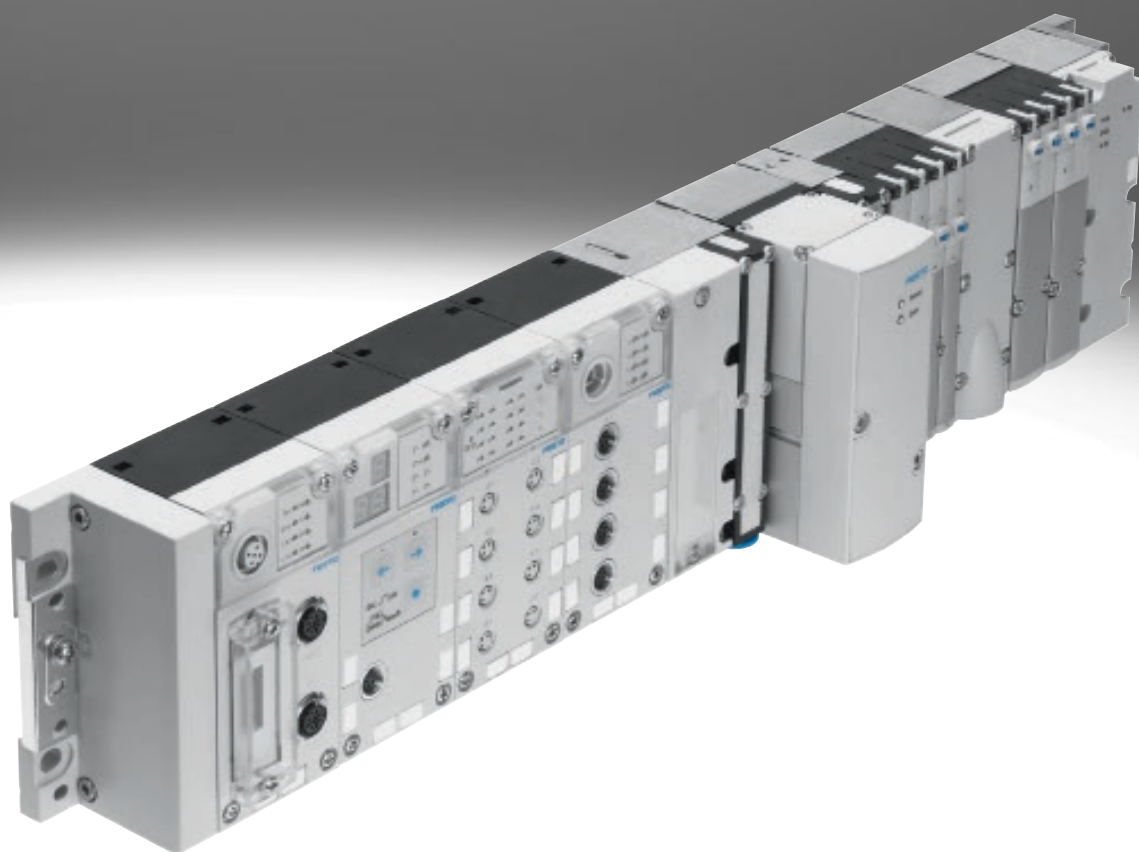

Key features

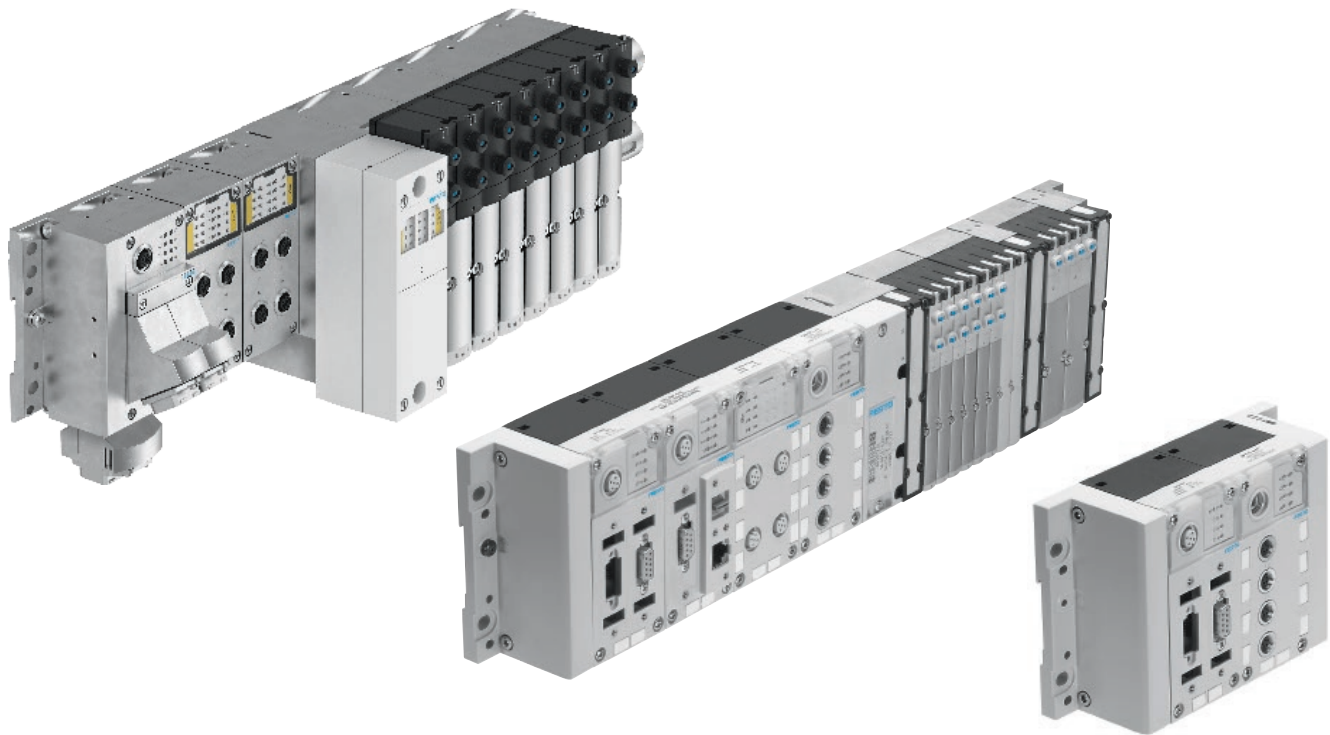

Key features

Installation concept

- Choice of several valve terminal types for different applications:
 - MPA-S
 - MPA-L
 - VTSA/VTSA-F/VTSA-F-CB
- Economical from the smallest configuration up to the maximum number of modules
- Up to 9 electrical input/output modules plus bus node and pneumatic interface/electronics modules for valves
- Extensive range of functions and connection options for the electrical modules
- Choice of connection technology for technically and economically optimised connections
- Can be used as a dedicated remote I/O module

Electric

- High operating voltage tolerance ($\pm 25\%$)
- Choice of M12x1, M18, 7/8" or AIDA push-pull connection for power supply
- Open to all fieldbus protocols and Ethernet
- Optional function and technology modules for pre-processing
- IT services and TCP/IP such as remote maintenance, remote diagnostics, web server, SMS and email alert
- Digital inputs and outputs, 4-way/8-way/16-way, optionally available with individual channel diagnostics
- Analogue inputs and outputs, 2-way/4-way
- Pressure inputs
- Temperature inputs
- Controller for pneumatic and electric axes
- IP65 and IP67 or IP20

Assembly

- Wall or DIN rail mounting, also on mobile units
- Conversions/extensions are possible at any time, individual linking with CPX metal design
- Modular system offering a range of configuration options
- Fully assembled and tested unit
- Reduced costs for selection, ordering, mounting and commissioning thanks to the central CPX terminal
- Choice of pneumatic components for optimised control chain
- Decentralised, subordinate CPI installation system improves cycle times by up to 30%
- Safe and convenient earthing thanks to earthing plate

Operation

- Fast troubleshooting thanks to an extensive selection of LEDs (some of which are multi-coloured) on the bus node and on all I/O modules
- Supports module and channel-related diagnostics
- Fieldbus/Ethernet remote diagnostics
- Innovative diagnostic support with integrated web server/web monitor or maintenance tool with USB adapter for PC
- Optimised commissioning thanks to parameterisable functions
- Reliable servicing with connection blocks and modules that are quick to replace without changing the wiring

Key features

Pneumatic variants of the CPX terminal

The electrical terminal CPX is a modular peripheral system for valve terminals.

The system is specifically designed so that the valve terminal can be adapted to suit a wide range of different applications.

The modular system design lets you configure the number of valves, inputs and additional outputs to suit the application.

With valve terminal – decentralised

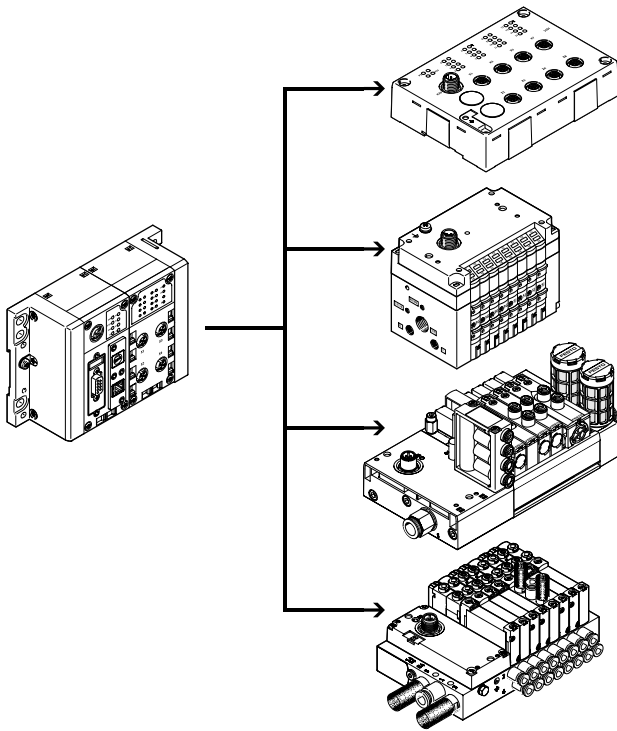

With valve terminal MPA-S – centralised

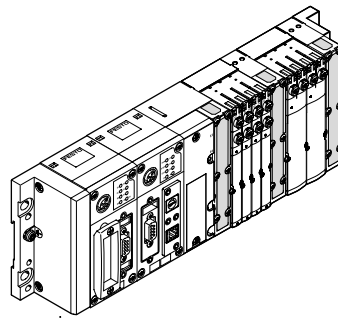

With valve terminal VTSA – centralised

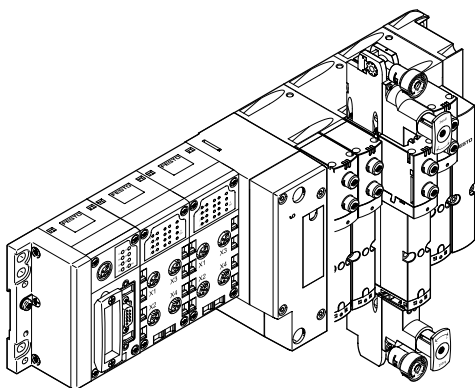

In metal design with valve terminal VTSA – centralised

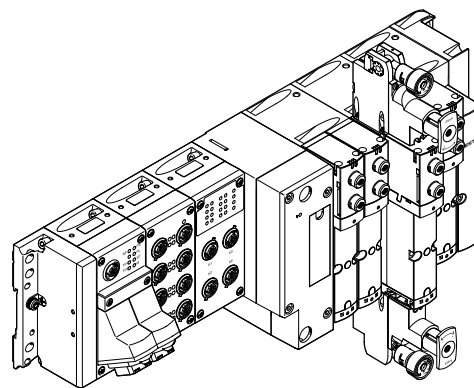

Key features

Variants of the CPX terminal controller (with bus node, without preprocessing)

Bus node

Different bus nodes are used for integration in the control systems of various manufacturers.

The CPX terminal can therefore be operated on over 90% of the most commonly used fieldbus systems:

- PROFIBUS DP
- PROFINET
- DeviceNet®
- CANopen
- CC-LINK®

Integration in universal networks based on Ethernet opens up new possibilities. Faster data transmission, real-time capability and above all additional IT services such as file transfer, web server, web monitor as integrated website in the CPX terminal, text message/email alerts, etc. open up a wide range of synergies.

Mail alarms, etc. open up a wide range of synergies.

These include standardised and universal communication technology across all areas, including operating level, management level and field level in the production environment, with protection to IP65, IP67.

The following protocols are supported:

- EtherNet/IP
- Modbus/TCP
- PROFINET
- POWERLINK
- EtherCAT®
- Sercos III

Bus node

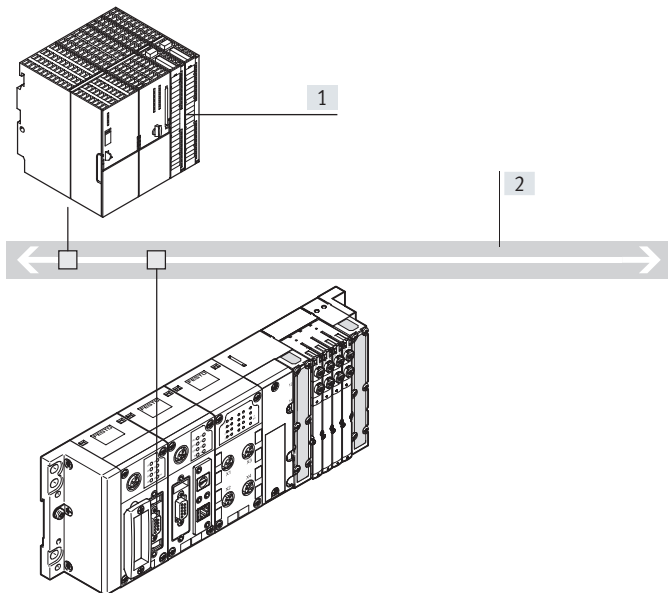

- [1] Higher-order controller (PLC)
- [2] Fieldbus

- Communication with the higher-order controller via fieldbus
- No preprocessing
- Fieldbus protocol dependent on CPX bus node used
- More than 90 I/Os, depending on bus node used

Industrial Ethernet bus node

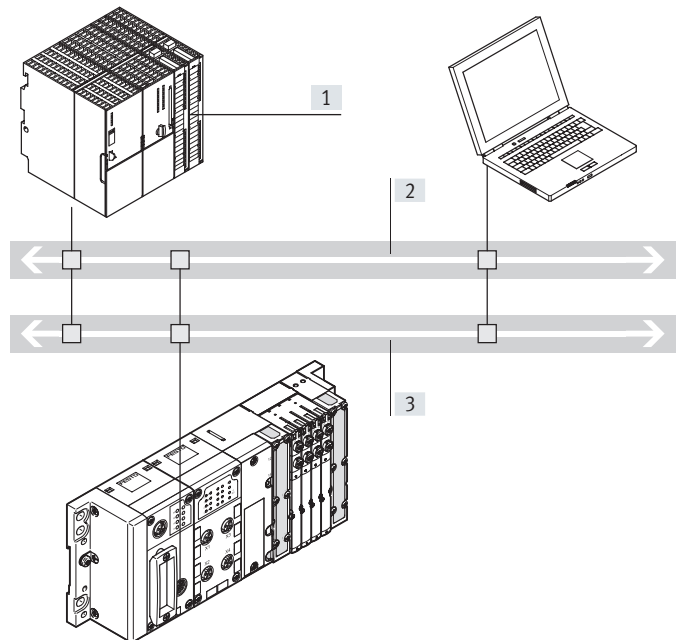

- [1] Higher-order controller (PLC)
- [2] Fieldbus
- [3] IT services:
 - Web
 - Email
 - Data transmission

- Connection to a higher-order controller directly via EtherNet/IP, Modbus/TCP, POWERLINK, EtherCAT® or PROFINET
- No preprocessing
- Monitoring via Ethernet and web applications
- More than 300 I/Os

Note

Every electrical interface can be combined with an appropriate number of I/O modules and/or pneumatic components, depending on its address capacity.

Likewise, every pneumatic variant of the CPX terminal can be operated with every electrical interface variant.

Key features

Variants of the CPX terminal controller (with preprocessing in the control block)

Control block

The optional front end controllers CPX-CEC enable simultaneous access via Ethernet, in parallel with a bus node, as well as stand-alone preprocessing.

Access via Modbus/TCP and EasyIP is also possible.

Commissioning, programming, and diagnostics using the Festo software tool FST with hardware configurator.

With control block in stand-alone mode

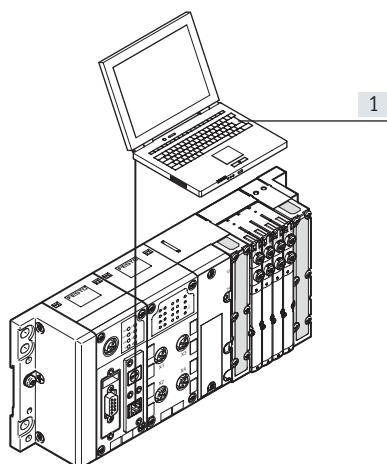

[1] CODESYS/FST

- Decentralised controller with direct machine mounting
- Downloading programs via Ethernet (or via the programming interface)
- Supports full expansion of all CPX peripherals
- More than 300 I/Os

Can be successfully used in the follow applications:

- Stand-alone individual workstations
- Interlinked, stand-alone sub-systems
- Automation using IT technology

With control block in Festo EasyIP mode

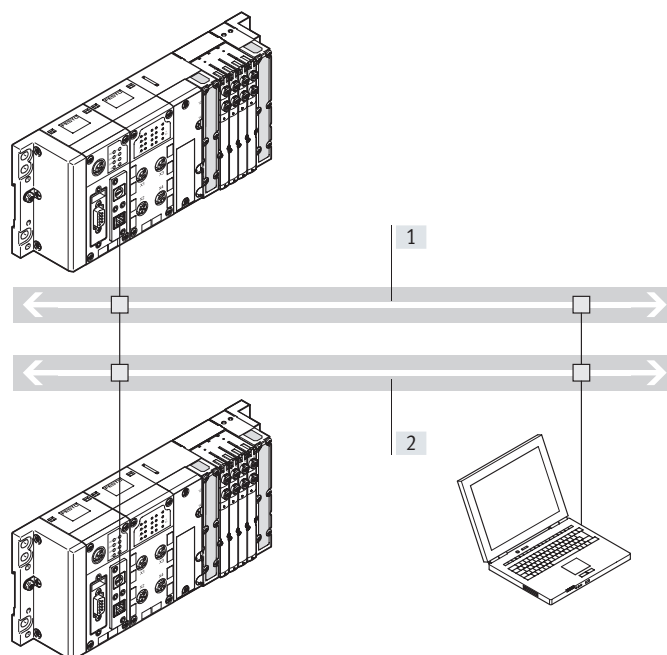

[1] Industrial Ethernet

- [2] IT services:
- Web
 - Email
 - Data transmission

- Fast preprocessing of the CPX peripherals in the control block
- Exchange of any data between the control blocks via EasyIP
- Remote diagnostics
- No higher-order controller is required
- More than 300 I/Os per CPX control block

Key features

Variants of the CPX terminal controller (with preprocessing in the control block)

With control block as remote controller on Ethernet

Remote controller via Ethernet as the preprocessing unit for decentralised, stand-alone sub-systems using IT technology.

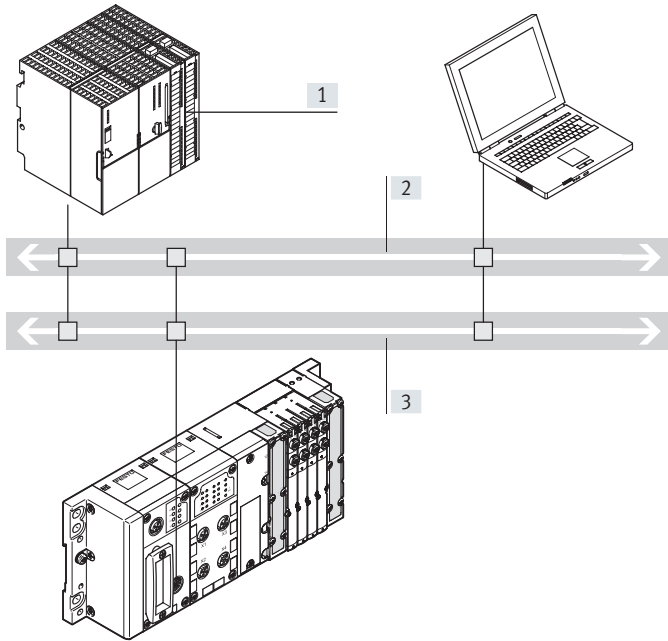

- [1] Higher-order controller (PLC)
- [2] Industrial Ethernet
- [3] IT services:
 - Web
 - Email
 - Data transmission

- Connection to a higher-order controller via Ethernet, no further bus node is required
- Monitoring via Ethernet and web applications
- Preprocessing of the CPX peripherals by CPX control block
- More than 300 I/Os

With control block as remote controller on the fieldbus

Fieldbus remote controller (combination with bus nodes for PROFIBUS DP, PROFINET, CANopen, DeviceNet®, CC-Link®, POWERLINK, Sercos III or EtherCAT) as the preprocessing unit for decentralised, stand-alone subsystems.

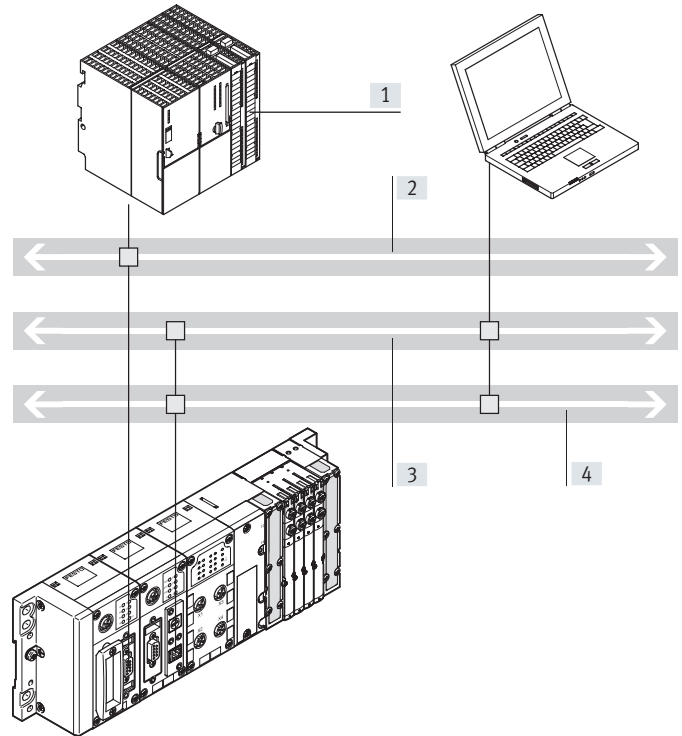

- [1] Higher-order controller (PLC)
- [2] Fieldbus
- [3] Industrial Ethernet
- [4] IT services:
 - Web
 - Email
 - Data transmission

- Fast preprocessing of the CPX peripherals in the control block
- Communication with the higher-order controller via fieldbus
- Optional additional monitoring via Ethernet and web applications
- Downloading programs via programming interface
- More than 300 I/Os, bus node is only used for communication with the higher-order PLC
- Option of two bus nodes for redundant communication configuration

Key features

Variants of the CPX terminal controller (with preprocessing in the control block)

With control block as CANopen fieldbus master

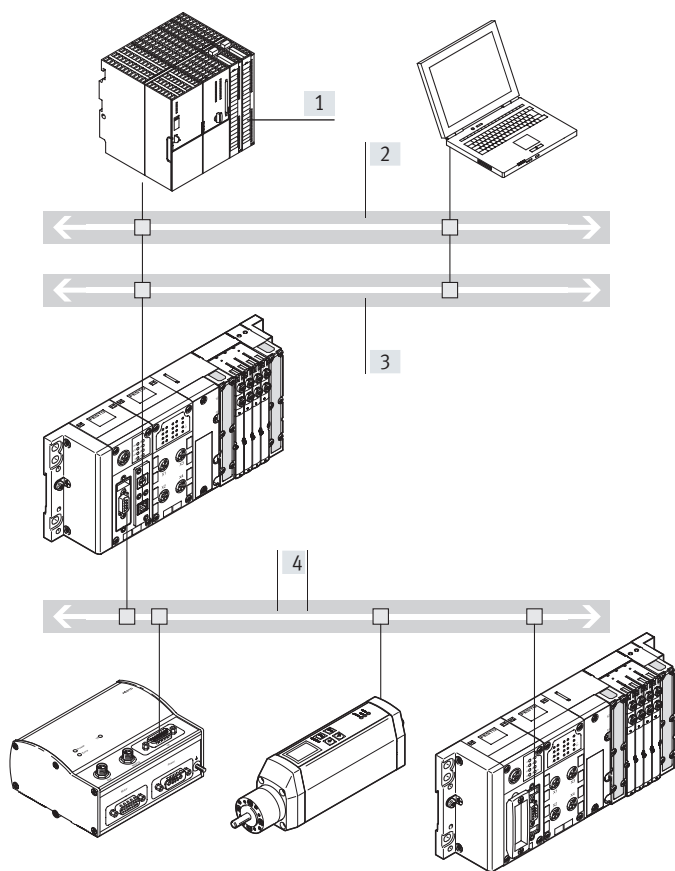

- [1] Higher-order controller (PLC)
- [2] Industrial Ethernet
- [3] IT services:
 - Web
 - Email
 - Data transmission
- [4] Fieldbus (CANopen)

Characteristics:

- Connection to a higher-order controller via Ethernet, no further bus node is required
- Monitoring via Ethernet
- Preprocessing of the CPX peripherals by CPX control block
- More than 300 I/Os
- Up to 128 stations with repeater technology on CANopen

Operating modes:

- Remote controller on Ethernet
- Control block in Festo EasyIP mode

Key features

Connection of inputs and outputs to the CPX terminal

Digital and analogue CPX I/O modules

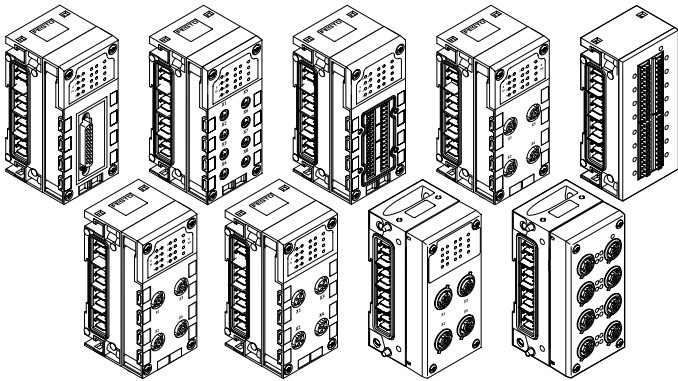

Electrical connection

The connection technology for sensors and additional actuators offers a wide range of digital and analogue input and output modules and is freely selectable, as appropriate to your standard or application. Polymer or metal connection blocks can be combined as required:

- Metal version
 - M12-5POL
- Polymer version:
 - M12-5POL
 - M12-5-PIN with quick lock and metal thread
 - M12-8POL
 - M8-3POL
 - M8-4POL
 - Sub-D
 - CageClamp® (with cover also to IP65, IP67)
 - Screw/spring-loaded terminal

With CPX-CP interface

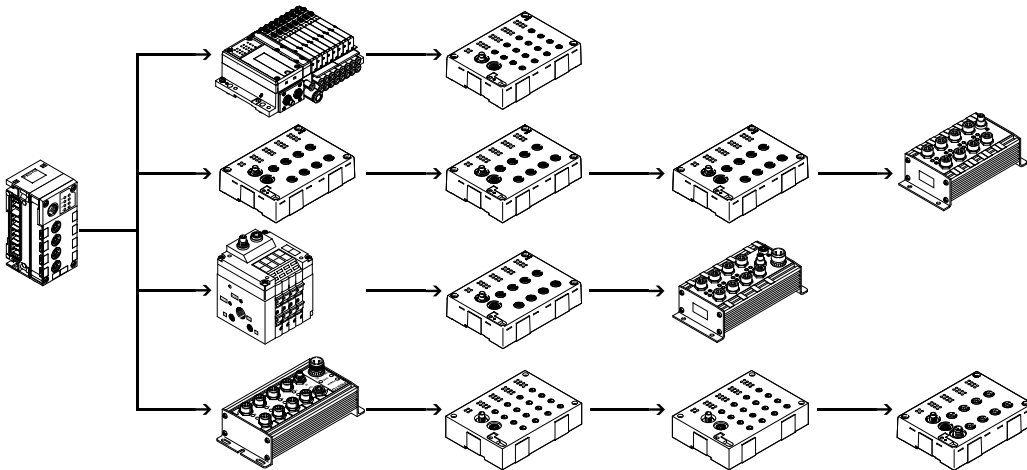

- Up to 4 strings per CP interface possible.
- Up to 4 subordinate CP modules can be combined in one string.
- Up to 32 I/Os can be connected per string.
- Modules with M8 and M12
- Several CP interface modules can be combined on one CPX terminal (depending on the controller used).
- Combination of centralised CPX I/O modules and decentrally mounted I/O modules of the installation system CPI.

Combined centralised and decentralised electrical connection (valve terminal with CP interface/output module)

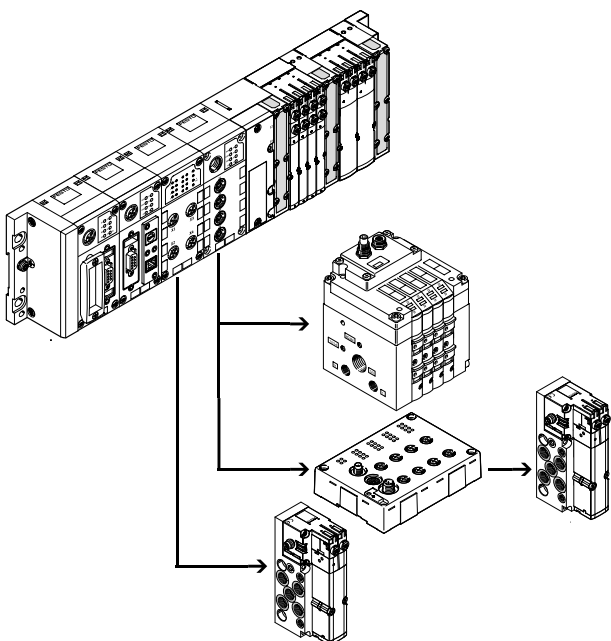

- Scalable to different requirements within a system
- One control interface in the system, reduces installation complexity with closely and widely spaced actuators
- Enables an optimum electrical and pneumatic control chain

Key features

Connection of inputs and outputs to the CPX terminal

With CPX-CTEL interface

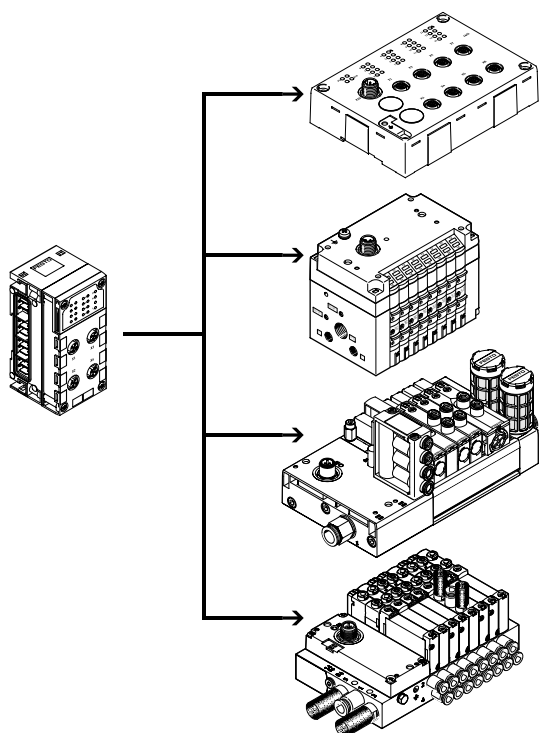

- Up to 4 devices with individual electronic protection per CPX CTEL master
- Max. 64 inputs/64 outputs per I-Port interface
- The maximum length of a string is 20 m.
- Input modules with 16 digital inputs (connection technology M8 3-pin and M12 5-pin)
- Valve terminals with I-Port interface (up to 48 solenoid coils, different valve functions)

Several CPX CTEL masters can be combined on one CPX terminal (depending on the controller used).
Combination of central CPX I/O modules and decentrally mounted I/O modules with I-Port interface.

With CPX-CTEL-2 interface

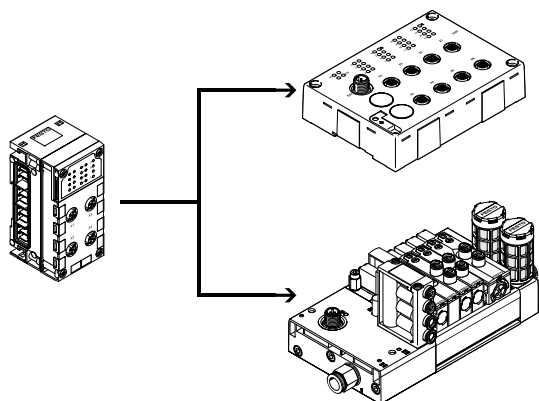

- Up to 2 IO-Link® devices with individual electronic protection per CPX-CTEL-2 interface
- Max. 16-byte inputs/16-byte outputs per IO-Link® device
- The maximum length of a string is 20 m.

Several CPX-CTEL-2 interfaces can be combined on one CPX terminal (depending on the controller used).
Combination of central CPX I/O modules and decentrally mounted I/O modules with IO-Link® interface.

Key features

Connection of inputs and outputs to the CPX terminal

Electric drives with axis interface CPX-CM-HPP

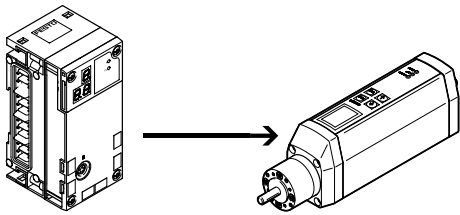

- Max. 4 individual electric axes possible per CPX-CM-HPP
- No programming required
- Standardised communication with the drives via the Festo Handling and Positioning Profile (FHPP)
- The control component is independent of the bus node used

Pneumatic drives with CPX-CMAX/CMPX

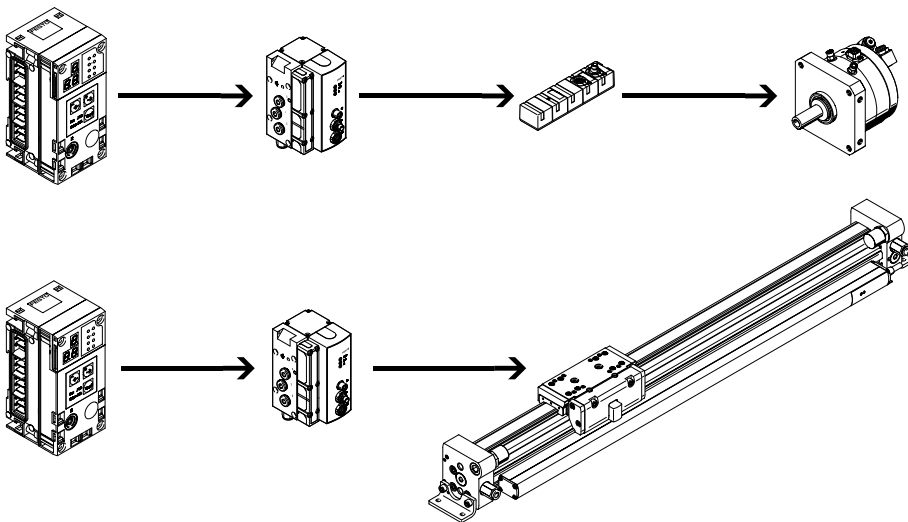

CPX-CMAX

- Position and force control, directly actuated or selected from one of 64 configurable positioning sets
- The configurable record sequencing function enables simple functional sequences to be realised
- Auto identification detects every station with its device data on the controller
- Control of a brake or clamping unit via the proportional directional control valve VPWP
- Up to 7 modules (max. 7 axes) can be operated in parallel and independently of each other
- Commissioning via the Festo configuration software FCT or via fieldbus

CPX-CMPX

- Fast travel between the mechanical end stops of the cylinder, stopping gently and without impact in the end position
- Fast commissioning via control panel, fieldbus or handheld terminal
- Improved downtime control
- Control of a brake or clamping unit via the proportional directional control valve VPWP
- Max. 9 end-position controllers can be actuated depending on the fieldbus
- All system data can be read and written via the fieldbus, including the mid-positions, for example:

Key features

Ordering

The CPX terminal with valve terminal is fully assembled according to your order specifications and individually tested. The finished valve terminal consists of the electrical peripherals including the required actuation and the selected components of the VTSA (ISO), VTSA-F, VTSA-F-CB, MPA-S or MPA-L modules. The CPX terminal with valve terminal is ordered using two separate order codes.

One order code defines the electrical peripherals type CPX, while the other specifies the pneumatic components of the valve terminal.

The electrical peripherals type CPX can also be configured without a valve terminal and can be used on a fieldbus. To order this, only the order code for the electrical peripherals is required.

The order lists for the pneumatic components can be found at

- Internet: vtsa
(Valve terminal VTSA)
- Internet: vtsa-f
(Valve terminal VTSA-F)
- Internet: vtsa-f-cb
(Valve terminal VTSA-F-CB)
- Internet: mpa-s
(Valve terminal MPA-S)
- Internet: mpa-l
(Valve terminal MPA-L)

The order lists for the CP/CPI components can be found at

- Internet: cpi
(Installation system CPI)

The order lists for the CTEU/CTEL components can be found at

- Internet: cteu
(I-Port interface/IO-Link®)

Peripherals overview

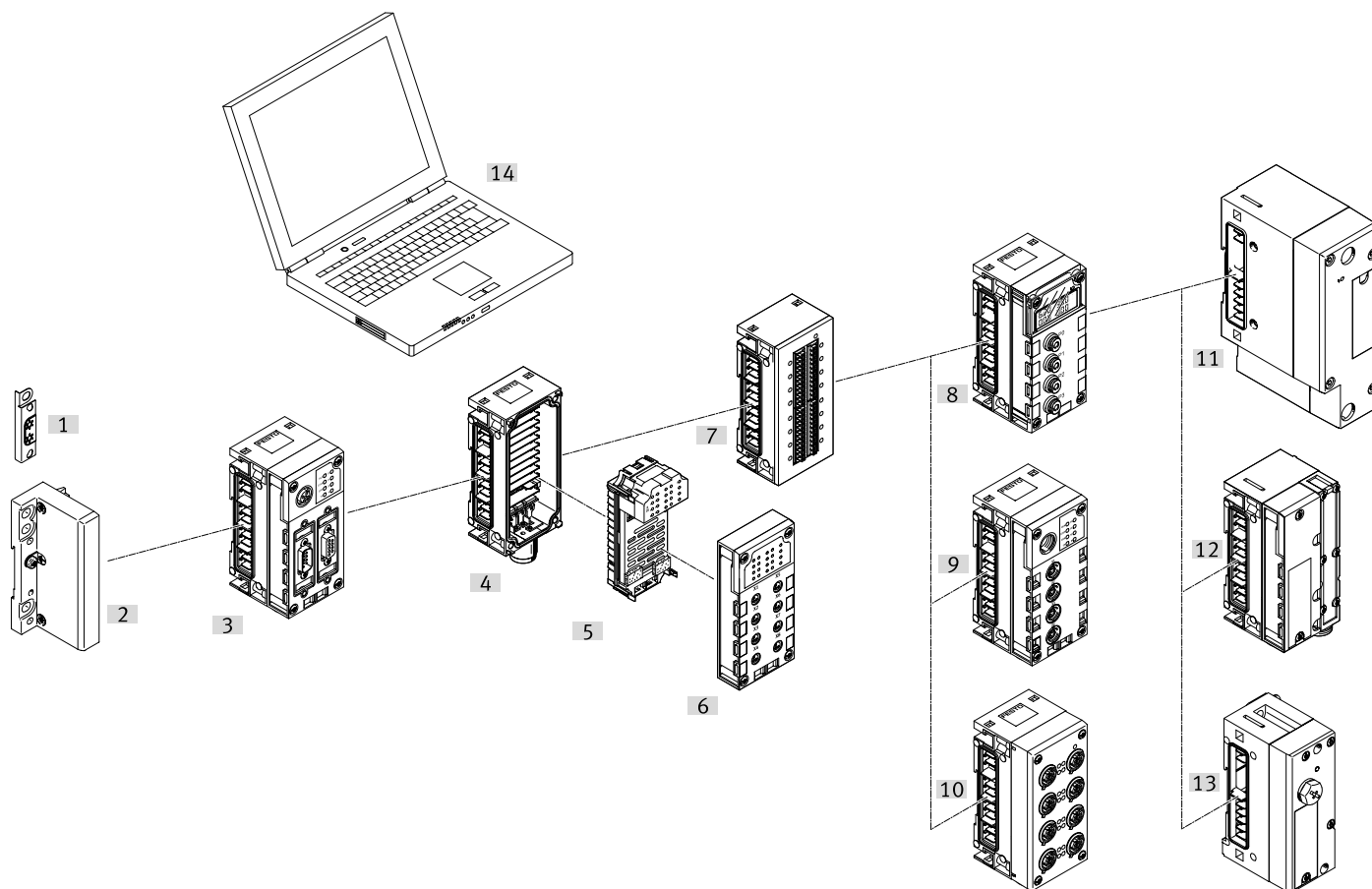

Designation	Type	Description	→ Page/Internet
[1] Earthing component	CPX-EPFE-EV	For right/left end plate	51
[2] End plate	CPX-EP	<ul style="list-style-type: none"> • Mounting holes for wall mounting • Functional earth connection • Special earthing plate for safe and easy connection to the machine bed or DIN rail • External power supply for the entire system 	51
[3] Bus node	CPX-FB CPX-M-FB	<ul style="list-style-type: none"> • Fieldbus/Industrial Ethernet connection using various types of connection technology • Setting fieldbus parameters via DIL switch • Display of fieldbus and peripheral equipment status via LED • PROFINET to AIDA standard in metal housing, fast start-up 	71
Control block	CPX-CEC	<ul style="list-style-type: none"> • Preprocessing, stand-alone controller or remote unit CPX-CEC • Connection via Ethernet TCP/IP or Sub-D programming interface • Setting operating modes via DIL switch and program selection via rotary switch • CPX-CMX products for controlling axes 	64
Gateway	CPX-IOT	<ul style="list-style-type: none"> • Separate CPX combination • Data gathering for connected components • Secure data transfer to a central storage location (MQTT broker) 	57
[4] Polymer interlinking block	CPX-GE	<ul style="list-style-type: none"> • Internal linking of the power supply and serial communication • External power supply for the entire system or for outputs or valves • Connection accessories for M18, 7/8" • Linking with tie rods 	50
Interlinking block, metal	CPX-M-GE	<ul style="list-style-type: none"> • Internal linking of the power supply and serial communication • External power supply for the entire system or for outputs • Transmission of the power supply • Connection accessories for M12x1, 7/8" or AIDA push-pull • Individual linking with M6 screws, individually expandable 	50

Peripherals overview

Designation	Type	Description	→ Page/Internet
[5] Electronics module	CPX-4DE	Input module with 4 digital inputs, positive logic (PNP)	140
	CPX-8DE	Input module with 8 digital inputs, positive logic (PNP)	
	CPX-8DE-D	Input module with 8 digital inputs, positive logic (PNP), enhanced diagnostic function	
	CPX-8NDE	Input module with 8 digital inputs, negative logic (NPN)	145
	CPX-F8DE-P	PROFIsafe input module with 8 digital inputs	
	CPX-16DE	Input module with 16 digital inputs, internal electronic fuse per module	151
	CPX-M-16DE-D	Input module with 16 digital inputs, internal electronic fuse per channel pair, for CPX in metal	
	CPX-4DA	Output module with 4 digital outputs, 1 A per channel	157
	CPX-8DA	Output module with 8 digital outputs, 0.5 A per channel	
	CPX-8DA-H	Output module with 8 digital outputs, 2.1 A per channel pair	
	CPX-8DE-8DA	Input/output module with 8 digital inputs and 8 digital outputs	163
	CPX-2ZE2DA	Counter module with 2 digital inputs and 2 digital outputs	168
	CPX-2AE-U-I	Input module with 2 analogue current or voltage inputs	172
	CPX-4AE-U-I	Input module with 4 analogue current or voltage inputs	
	CPX-4AE-I	Input module with 4 analogue current inputs	
	CPX-4AE-T	Input module for temperature inputs	179
	CPX-4AE-TC	Input module for temperature inputs with cold junction compensation	183
CPX-2AA-U-I	Output module with 2 analogue current or voltage outputs	187	
CPX-FVDA-P2	PROFIsafe shut-off module for shutting off the supply voltage for valves, with two digital outputs	191	
[6] Polymer connection block	CPX-AB	<ul style="list-style-type: none"> Choice of 8 connection technology variants Degree of protection IP65, IP67 or IP20 Can be combined with the electronics modules Connection accessories for M8/M12/Sub-D Connecting cables M8/M12/Sub-D, etc. Modular system for M8/M12 connecting cables 	–
[7] Connection block including electronics module and interlinking block	CPX-L	<ul style="list-style-type: none"> Spring-loaded terminal Degree of protection IP20 Digital input module with 16 inputs Digital I/O module with 8 inputs and 8 outputs Polymer connection block 	–
[8] Analogue electronics module for pressure inputs	CPX-4AE-P	<ul style="list-style-type: none"> Pneumatic connection QS-4 Degree of protection IP 65, IP67 4 analogue pressure inputs (0 ... 10 bar, –1 ... +1 bar) 	177
[9] CP interface CTEL interface	CPX-CP	<ul style="list-style-type: none"> Interfaces for decentralised installation systems, thus optimising the pneumatic control chains (short tubes/short cycle times) 	112
	CPX-CTEL	<ul style="list-style-type: none"> Actuation for I/O modules and valve terminals Power supply and bus interface via the same cable Connection technology M9, M12 Degree of protection IP 65, IP67 	117
[10] Metal connection block	CPX-M-AB	<ul style="list-style-type: none"> Can be combined with the electronics modules Connection technology M12x1, 5-pin Degree of protection IP 65, IP67 Connection accessories for M12 Connecting cables M12 Modular system for choice of connecting cables M12 	–
[11] Pneumatic interface VTSA	VABA-S6	<ul style="list-style-type: none"> Control of valve terminal VTSA/VTSA-F/VTSA-F-CB Control of pressure sensors 	222
[12] Pneumatic interface MPA-S	VMPA-FB	<ul style="list-style-type: none"> Control of valve terminal MPA-S Control of pressure sensors Control of proportional pressure regulators 	217
[13] Pneumatic interface MPA-L	VMPAL-EPL-CPX	Control of valve terminal MPA-L	220
[14] Web monitor	–	<ul style="list-style-type: none"> Website integrated in the CPX terminal Dynamic status indication Online diagnostics and SMS/email alert 	–

Peripherals overview

Individual overview of modules

Bus node

→ page 71

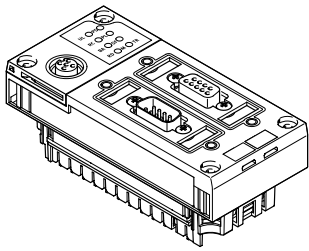

Bus node for

- PROFIBUS DP
 - DeviceNet®
 - CANopen
 - CC-LINK®
 - EtherNet/IP
- PROFINET
 - POWERLINK
 - EtherCAT®
 - Sercos III

Control block

→ page 64

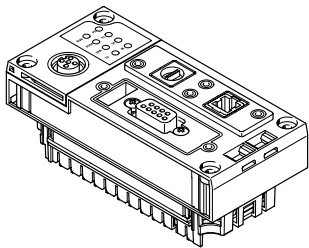

CPX-CEC

- Programming with CODESYS
- Ethernet interface
- Modbus/TCP
- EasyIP
- CANopen master

Gateway

→ page 57

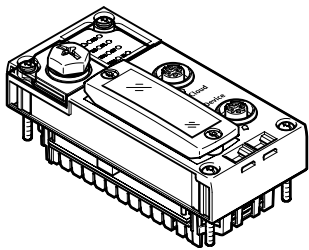

CPX-IOT

- Continuous transfer of operating data from connected Festo components to a central storage location (customer's MQTT broker)
- Ethernet interface

CP interface

→ page 112

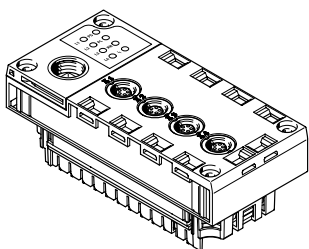

Interface CPX-CP

- 4 CP strings
- Max. 4 modules per string
- 32 inputs/32 outputs per string
- CPI functionality

CTEL interface

→ page 117

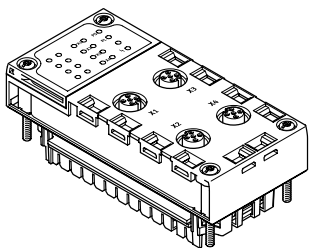

Interface CPX-CTEL

- CTEL master
- Max. 4 devices with individual electronic protection
- Max. 64 inputs/64 outputs per I-Port interface
- The maximum length of a string is 20 m

Electrical interface CPX-CTEL-2

→ page 123

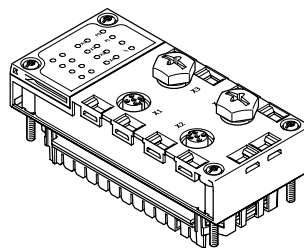

Interface CPX-CTEL-2

- Master for IO-Link®
- Max. 2 devices with individual electronic protection
- The process data length of the inputs and outputs is limited to 16 bytes for inputs and 16 bytes for outputs per port
- The maximum length of a string is 20 m

Peripherals overview

Individual overview of modules

Modules for actuating electric drive units

→ page 128

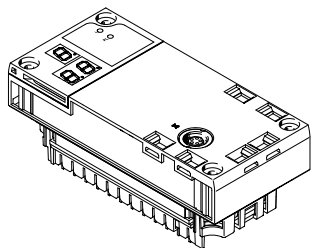

CPX-CM-HPP

- Axis interface
- CAN bus for up to 4 individual electric axes

Modules for actuating pneumatic drive units

→ page 131

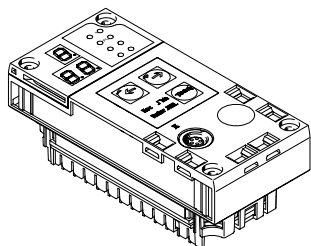

CPX-CMAX

- Axis controller
- Position and force control
- 64 configurable positioning records
- Auto-identification
- Control of a brake or clamping unit via the proportional directional control valve VPWP

CPX-CMPX

- End-position controller
- Fast travel between the mechanical end stops of the cylinder
- Smooth travel into the end position
- Improved downtime control
- Control of a brake via the proportional directional control valve VPWP

CPX-CMIX

- Measuring module
- CAN input (Festo specification) for measuring signal
- Detecting the absolute position values or speed values of the connected drive

Polymer connection block

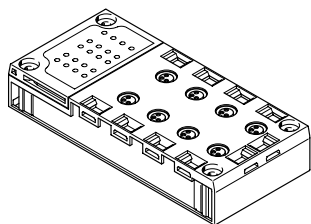

Direct machine mounting

(degree of protection IP65, IP67)

- M8-3POL
- M8-4POL
- M12-5POL
- M12-5POL quick lock, shielded with metal thread
- M12-8POL
- Sub-D
- Spring-loaded terminal with cover

Protected fitting space

(degree of protection IP20)

- Spring-loaded terminal

Shielding concept

- Optional screening plate for connection blocks with M12 connection technology

Metal connection block

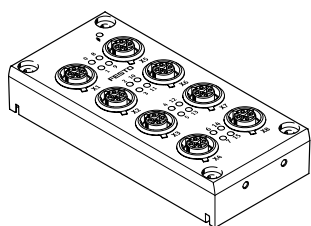

Direct machine mounting

(degree of protection IP65, IP67)

- M12-5POL

Connection block including electronics module and interlinking block

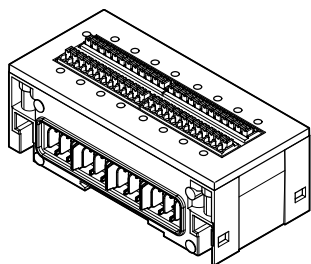

Mounting in the control cabinet

(degree of protection IP20)

- Polymer connection block
- Spring-loaded terminal
- Digital input module with 16 inputs
- Digital I/O module with 8 inputs and 8 outputs

Peripherals overview

Individual overview of modules

Digital electronics module for inputs/outputs

→ page 140

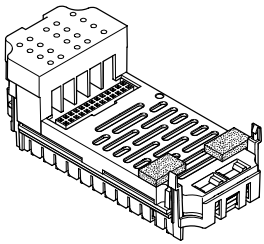

Digital inputs

- 4 digital inputs
- 8 digital inputs NPN
- 8 digital inputs PNP
- 8 digital inputs PNP with individual channel diagnostics
- 16 digital inputs
- 16 digital inputs with individual channel diagnostics

Digital outputs

- 4 digital outputs (1 A per channel, individual channel diagnostics)
- 8 digital outputs (0.5 A per channel, individual channel diagnostics)
- 8 digital outputs (2.1 A/50 W lamp load per channel pair, individual channel diagnostics)

Multi I/O modules

- 8 digital inputs and 8 digital outputs
- 2 digital inputs (counter channels, connection to various encoders) and 2 digital outputs (directly controlled by the input values)

Analogue electronics module for inputs/outputs

→ page 172

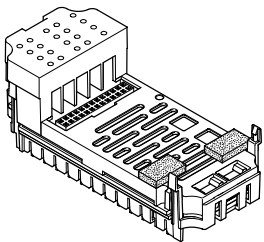

Analogue inputs

- 2 analogue inputs (0 ... 10 V DC, 0 ... 20 mA, 4 ... 20 mA)
- 4 analogue inputs (1 ... 5 V, 0 ... 10 V, -5 ... +5 V, -10 ... +10 V, 0 ... 20 mA, 4 ... 20 mA, -20 ... +20 mA)

Analogue temperature inputs

- 4 analogue inputs for temperature measurement (Pt100, Pt200, Pt500, Pt1000, Ni100, Ni120, Ni500, Ni1000)
- 4 analogue inputs for temperature measurement (thermocouple and PT1000 sensor for cold junction compensation)

Analogue outputs

- 2 analogue outputs (0 ... 10 V DC, 0 ... 20 mA, 4 ... 20 mA)

PROFIsafe input module

→ page 145

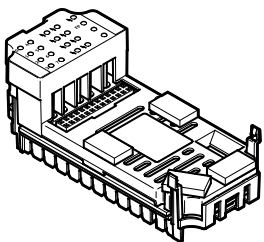

Digital inputs

- 8 digital inputs
- 11 function modes
- 5 independent pulse outputs

PROFIsafe shut-off module

→ page 191

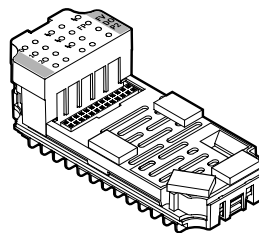

Digital outputs

- 2 digital outputs
- Supply voltage for valves can be shut off

Peripherals overview

Individual overview of modules

Analogue electronics module for pressure inputs

→ page 177

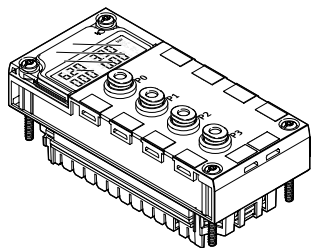

Analogue inputs

- 4 analogue pressure inputs (0 ... 10 bar, -1 ... +1 bar)

Polymer interlinking block – Interlinking using tie rods

→ page 200

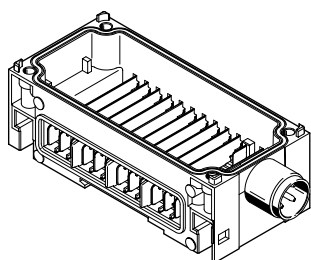

System linking

- Different voltages for supplying the modules
- Serial communication between the modules

System supply

- M18, 4 pin
- 7/8" 4-pin or 5-pin

In addition to system linking, power supply for the

- Electronics plus sensors (16 A)
- Valves plus actuators (16 A)

Additional supply

In addition to system linking, power supply for the

- Actuators (16 A per supply)

Power supply for the

- Valves (16 A per supply)

Extendibility

- Can be extended by an interlinking block with tie rod extension CPX-ZA-1-E

Metal interlinking block – Individual linking

→ page 201

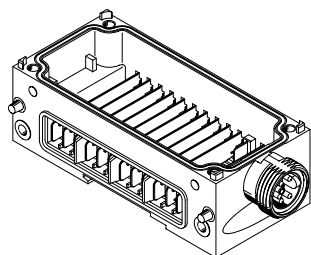

System linking

- Different voltages for supplying the modules
- Serial communication between the modules

System supply

- 7/8" 4-pin or 5-pin
- M12x1, L-coded, 5-pin
- AIDA push-pull

In addition to system linking, power supply for the

- Electronics plus sensors (16 A)
- Valves plus actuators (16 A)

Additional supply

In addition to system linking, power supply for the

- Actuators (16 A per supply)

Power supply for the

- Valves (16 A per supply)

System forwarding

In addition to system linking, transmission of power supply from the

- Electronics plus sensors (16 A)
- Valves plus actuators (16 A) to a further CPX terminal or another consuming device.

Extendibility

- Can be expanded as required by up to 10 interlinking blocks

Note

Polymer interlinking blocks (tie rods) and metal interlinking blocks (individual linked) cannot be combined due to their different interlinking systems.

Note

The 7/8" supply is subject to the following restrictions due to the available accessories:

- 5-pin 8 A
- 4-pin 10 A

Note

Appropriate interlinking blocks (CPX...-VL) must be used in ATEX environments as per the certification (→ page 48). The maximum supply is limited to 8 A for these modules.

Peripherals overview

Individual overview of modules

Pneumatic interface MPA-S

→ page 217

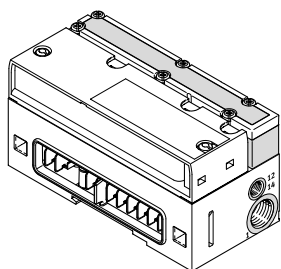

- Valve terminal
- MPA1 (360 l/min)
 - MPA14 (550 l/min)
 - MPA2 (700 l/min)
 - Up to 128 solenoid coils
 - Up to 16 modules can be configured
 - For CPX polymer design
 - For CPX metal design
 - Control of pressure sensors
 - Proportional pressure regulators
 - Pressure sensors
 - Proportional pressure regulators

Pneumatic interface MPA-L

→ page 220

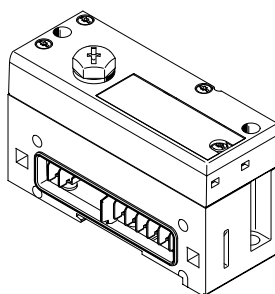

- Valve terminal
- MPA1 (360 l/min)
 - MPA14 (670 l/min)
 - MPA2 (870 l/min)
 - Up to 32 solenoid coils
 - For CPX polymer design

Pneumatic interface VTSA/VTSA-F

→ page 222

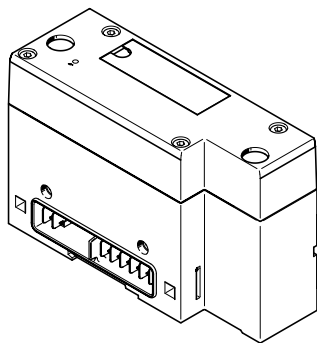

- Valve terminal (valve flow rate according to width)
- 18 mm (700 l/min)
 - 26 mm (1350 l/min)
 - 42 mm (1300 l/min)
 - 52 mm (2900 l/min)
 - 65 mm (4000 l/min)
 - Max. 32 valve positions/max. 32 solenoid coils
 - For CPX polymer design
 - For CPX metal design

Pneumatic interface VTSA-F-CB

→ page 224

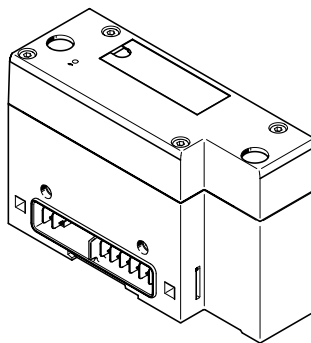

- Valve terminal (valve flow rate according to width)
- 18 mm (700 l/min)
 - 26 mm (1350 l/min)
 - 42 mm (1300 l/min)
 - 52 mm (2900 l/min)
 - Max. 24 valve positions/max. 24 solenoid coils
 - For CPX polymer design
 - For CPX metal design

Pneumatic interface VTSA-F-CB

→ page 224

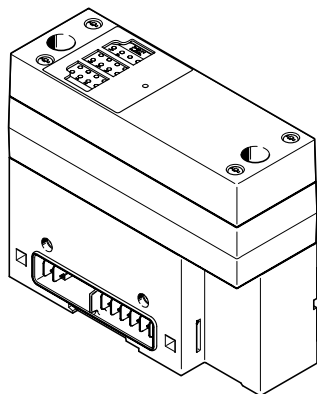

- Valve terminal (valve flow rate according to width)
- 18 mm (700 l/min)
 - 26 mm (1350 l/min)
 - 42 mm (1300 l/min)
 - 52 mm (2900 l/min)
 - Max. 24 valve positions/max. 24 solenoid coils
 - For CPX metal design
 - With 3 voltage zones within the valve terminal that can be securely shut down via fieldbus
 - With 2 voltage zones within the valve terminal that can be securely shut down via fieldbus and one power supply for external consuming devices that can be securely shut down via fieldbus

Pneumatic interface VTSA-F-CB

→ page 224

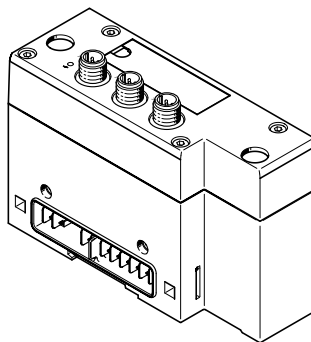

- Valve terminal (valve flow rate according to width)
- 18 mm (700 l/min)
 - 26 mm (1350 l/min)
 - 42 mm (1300 l/min)
 - 52 mm (2900 l/min)
 - Max. 24 valve positions/max. 24 solenoid coils
 - For CPX polymer design
 - For CPX metal design
 - 3 external voltage supplies for voltage zones within the valve terminal that can be shut down individually

Peripherals overview

Individual overview of modules

End plate for polymer/metal design

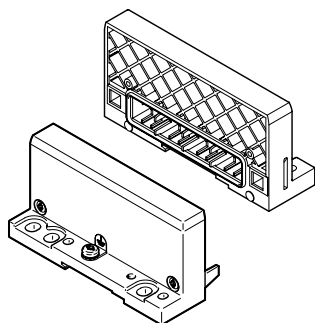

End plate

- Left
- Right (for using the CPX terminal without valves)

End plate with system supply

→ page 196

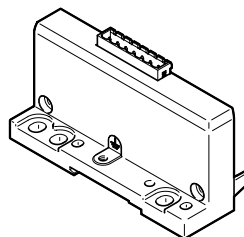

End plate

- Left
- For polymer design
- Different voltages for supplying the CPX terminal

End plate with extension

→ page 198

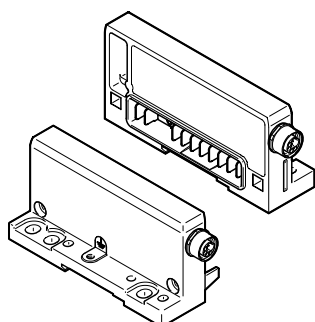

End plate

- Left
- Right
- Enables the CPX terminal to be separated into two interconnected units (series)
- Simplifies control cabinet installation
- For polymer or metal design

Earthing plate (for end plate for polymer design)

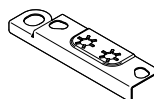

Earthing plate

- For safe and easy connection to the machine bed or DIN rail, suitable for right-hand and left-hand end plate
- Mounting and earthing in a single processing step, which means:
 - Time saving of 50%
 - No additional material required

General basic data and guidelines

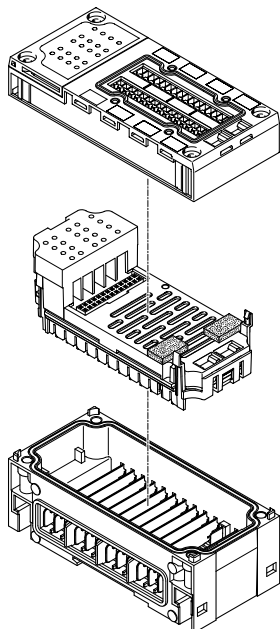

Max. 11 modules in total:

- One bus node and/or one control block, freely positionable
- Up to 9 additional input/output modules, freely positionable
- An additional pneumatic interface always positioned as the last module on the right-hand side
 - For VTSA, VTSA-F: Fixed operating range, set using DIL switch
 - For VTSA-F-CB: Fixed operating range
 - For MPA-S: 16 MPA modules can be configured
 - For MPA-L: Fixed operating range, set using rotary switch
- Address capacity max. 512 inputs and 512 outputs, depending on bus node or control block
- One interlinking block with system supply
- Several interlinking blocks with additional supplies
 - Always positioned to the right of the interlinking block with system supply
- With just a few exceptions, the connection blocks can be freely combined with the electronics modules for inputs/outputs, either in metal or polymer version (→ table below)
- The electronics modules for inputs/outputs can be combined with various interlinking blocks

- Polymer interlinking blocks (tie rods) and metal interlinking blocks (individual linked) cannot be combined due to their different interlinking systems.

Peripherals overview

Combinations of connection blocks and digital input modules					
	Digital electronics modules				
	CPX-4DE	CPX-8DE	CPX-8DE-D	CPX-8NDE	CPX-F8DE-P
Connection blocks, polymer design					
CPX-AB-8-M8-3POL	■	■	■	■	–
CPX-AB-8-M8X2-4POL	–	–	–	–	–
CPX-AB-4-M12x2-5POL	■	■	■	■	–
CPX-AB-4-M12x2-5POL-R	■	■	■	■	–
CPX-AB-8-M12X2-5POL	–	–	–	–	–
CPX-AB-4-M12-8POL	–	–	–	–	–
CPX-AB-8-KL-4POL	■	■	■	■	■
CPX-AB-1-SUB-BU-25POL	■	■	■	■	–
CPX-AB-ID-P	–	–	–	–	■
Connection blocks, metal design					
CPX-M-AB-4-M12X2-5POL	■	■	■	■	■
CPX-M-AB-4-M12X2-5POL-T	–	–	–	–	■
CPX-M-AB-8-M12X2-5POL	–	–	–	–	–

Combinations of connection blocks and digital input modules			
	Digital electronics modules		
	CPX-16DE	CPX-L-16DE	CPX-M-16DE-D
Connection blocks, polymer design			
CPX-AB-8-M8-3POL	–	–	–
CPX-AB-8-M8X2-4POL	■	–	–
CPX-AB-4-M12x2-5POL	–	–	–
CPX-AB-4-M12x2-5POL-R	–	–	–
CPX-AB-8-M12X2-5POL	–	–	■
CPX-AB-4-M12-8POL	–	–	–
CPX-AB-8-KL-4POL	■	–	–
CPX-AB-1-SUB-BU-25POL	■	–	–
CPX-AB-ID-P	–	–	–
Connection blocks, metal design			
CPX-M-AB-4-M12X2-5POL	–	–	–
CPX-M-AB-4-M12X2-5POL-T	–	–	–
CPX-M-AB-8-M12X2-5POL	–	–	■

Peripherals overview

Combination of connection blocks with digital output modules and multi I/O modules							
	Digital electronics modules						
	CPX-4DA	CPX-8DA	CPX-8DA-H	CPX-8DE-8DA	CPX-L-8DE-8DA	CPX-2ZE2DA	CPX-FVDA-P2
Connection blocks, polymer design							
CPX-AB-8-M8-3POL	■	■	–	–	–	–	–
CPX-AB-8-M8X2-4POL	■	■	■	–	–	–	–
CPX-AB-4-M12x2-5POL	■	■	–	–	–	–	–
CPX-AB-4-M12x2-5POL-R	■	■	■	–	–	–	–
CPX-AB-8-M12X2-5POL	–	–	–	–	–	–	–
CPX-AB-4-M12-8POL	–	–	–	■	–	–	–
CPX-AB-8-KL-4POL	■	■	■	■	–	–	■
CPX-AB-1-SUB-BU-25POL	■	■	■	■	–	–	–
CPX-AB-ID-P	–	–	–	–	–	–	–
Connection blocks, metal design							
CPX-M-AB-4-M12X2-5POL	■	■	■	–	–	–	■
CPX-M-AB-4-M12X2-5POL-T	–	–	–	–	–	–	–
CPX-M-AB-8-M12X2-5POL	–	–	–	–	–	–	–
Combinations of connection blocks and analogue electronics modules for inputs/outputs							
	CPX-2AE-U-I	CPX-4AE-U-I	CPX-4AE-I	CPX-2AA-U-I	CPX-4AE-P	CPX-4AE-T	CPX-4AE-TC
Connection blocks, polymer design							
CPX-AB-8-M8-3POL	–	–	–	–	–	–	–
CPX-AB-8-M8X2-4POL	–	–	–	–	–	–	–
CPX-AB-4-M12x2-5POL	■	■	■	■	–	■	■
CPX-AB-4-M12x2-5POL-R	■	■	■	■	–	■	■
CPX-AB-8-M12X2-5POL	–	–	–	–	–	–	–
CPX-AB-4-M12-8POL	–	–	–	–	–	–	–
CPX-AB-8-KL-4POL	■	■	■	■	–	■	■
CPX-AB-1-SUB-BU-25POL	■	■	■	■	–	–	–
CPX-AB-ID-P	–	–	–	–	–	–	–
Connection blocks, metal design							
CPX-M-AB-4-M12X2-5POL	■	■	■	■	–	■	■
CPX-M-AB-4-M12X2-5POL-T	–	–	–	–	–	–	–
CPX-M-AB-8-M12X2-5POL	–	–	–	–	–	–	–

Key features – Electrical components

Electrical connection – Connection block

CPX-AB-8-M8-3POL with connection socket M8, 3-pin

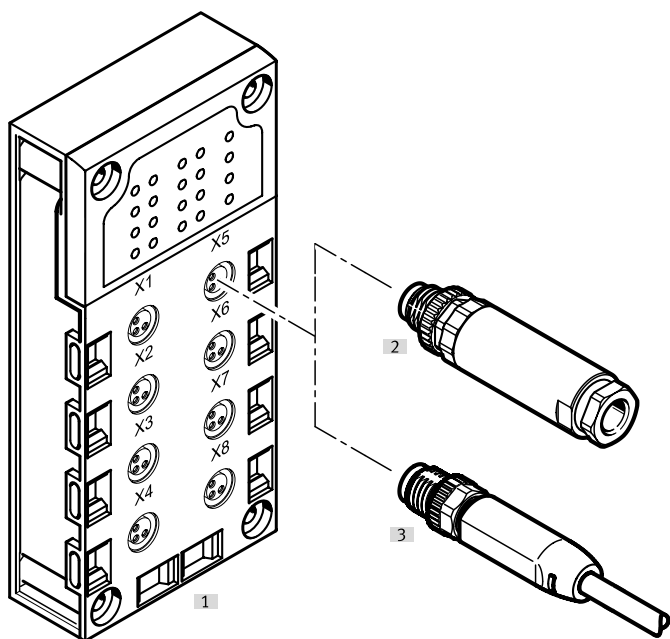

- Compact for pre-assembled individual connection
- 8 sockets
- 3-pin design for connecting one channel per socket

Note
Festo delivers pre-assembled connecting cables M8/M12 (modular system NEBA) on request:

- Tailored to the application
- Perfect fit
- Easy to install

Combination of connection block and electrical connection technology

Connection block	Connection technology	Plug connector/connecting cable	Connection technology
[1] CPX-AB-8-M8-3POL	Socket, M8, 3-pin	[2] NECB-S-M8G3-C2	Screw terminals
		[3] NEBA-...-M8G3 (Modular system for choice of connecting cables)	Socket, M8, 3-pin
			Socket, M8, 4-pin
			Socket M12, 5-pin
			Open cable end

Key features – Electrical components

Electrical connection – Connection block

CPX-AB-8-M8X2-4POL with connection socket M8, 4-pin

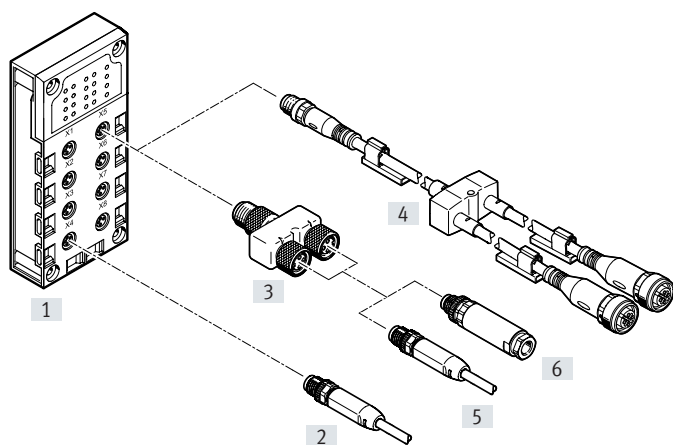

- Compact for pre-assembled individual connection
- 8 sockets
- 4-pin design for connecting 2 channels per socket

Combination of connection block and electrical connection technology

Connection block	Connection technology	Plug connector/connecting cable	Connection technology	Plug connector/connecting cable	Connection technology
[1] CPX-AB-8-M8X2-4POL	Socket, M8, 4-pin	[2] NEBA-...-M8G4 (Modular system for choice of connecting cables)	Socket, M8, 3-pin	–	–
			Socket, M8, 4-pin	–	–
			Socket M12, 5-pin	–	–
			Open cable end	–	–
		[3] NEDY-L2R1-V1-M8G3-N-M8G4 (T-adaptor)	1x plug M8, 4-pin to 2x socket, M8, 3-pin	[6] NECB-S-M8G3-C2	Screw terminals
		[4]NEDY-... (modular system for all types of sensor/ actuator distributor)	2x socket, M8, 3-pin 2x socket, M8, 4-pin 2x socket, M12, 5-pin 2x socket, type A 2x socket, type B 2x socket, type C 2x socket, plug pattern H 2x socket, plug pattern ZB 2x socket, plug pattern ZC 2x open cable end	[5] NEBA-...-M8G3 (Modular system for choice of connecting cables)	Socket, M8, 3-pin Socket, M8, 4-pin Socket M12, 5-pin Open cable end
				–	–
				–	–
				–	–
				–	–
				–	–
				–	–
				–	–
–	–				

Key features – Electrical components

Electrical connection – Connection block

CPX-AB-4-M12x2-5POL and CPX-AB-4-M12x2-5PPOL-R with connection socket M12, 5-pin

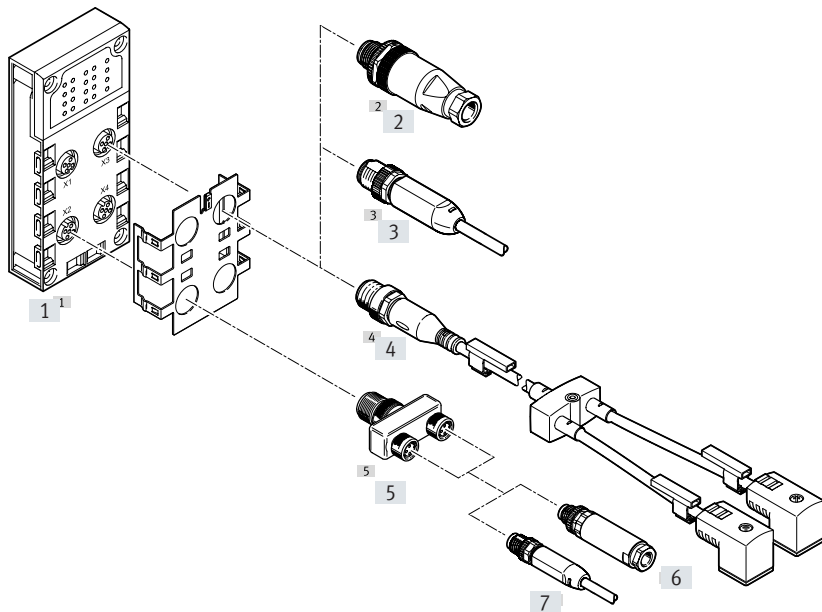

- Suitable for self-assembly and sturdy with 2 channels per connection
- 4 sockets
- 5-pin design per connection
- Version ...-R with quick lock technology and metal thread for shielding
- With two channels per connection, the corresponding input signals can be easily connected via a T-adapter and conventional cables with M8 connection.

Key features – Electrical components

Combination of connection block and electrical connection technology					
Connection block	Connection technology	Plug connector/connecting cable	Connection technology	Plug connector/connecting cable	Connection technology
[1] CPX-AB-4-M12x2-5POL CPX-AB-4-M12x2-5POL-R	Socket M12, 5-pin	[2] NECB-S-M12G4-C2	Screw terminals	–	–
		[2] NECB-S-M12G5-C2	Screw terminals	–	–
		[2] NECB-S-M12G4-C2-D	Screw terminals, for two cables	–	–
		[2] NECB-S-M12G5-C2-D	Screw terminals, for two cables	–	–
		[3] NEBA-...-M12G5 (Modular system for choice of connecting cables)	Socket, M8, 4-pin	–	–
			Socket M12, 5-pin	–	–
			Open cable end	–	–
		[4] NEDY-... (modular system for all types of sensor/ actuator distributor)	2x socket, M8, 3-pin	–	–
			2x socket, M8, 4-pin	–	–
			2x socket, M12, 5-pin	–	–
			2x socket, type A	–	–
			2x socket, type B	–	–
			2x socket, type C	–	–
			2x socket, plug pattern H	–	–
			2x socket, plug pattern ZB	–	–
			2x socket, plug pattern ZC	–	–
		[5] NEDY-L2R1-V1-M8G3-N-M12G4 (T-adapter)	Plug M12, 4-pin to 2x socket, M8, 3-pin	[6] NECB-S-M8G3-C2	Screw terminals
			[5] NEDY-L2R1-V1-M12G5-N-M12G4 (T-adapter)	Plug M12, 4-pin to 2x socket, M12, 5-pin	[7] NEBA-...-M8G3 (Modular system for choice of connecting cables)
		[6] NECB-S-M12G4-C2			Screw terminals
		[6] NECB-S-M12G5-C2			Screw terminals
		[6] NECB-S-M12G4-C2-D			Screw terminals, for two cables
		[6] NECB-S-M12G5-C2-D			Screw terminals, for two cables
		[7] NEBA-...-M12G5 (Modular system for choice of connecting cables)			Socket, M8, 4-pin
Socket M12, 5-pin	–				–
Open cable end	–	–			

Key features – Electrical components

Electrical connection – Connection block (metal design)

CPX-M-AB-4-M12X2-5POL and CPX-M-AB-4-M12X2-5POL-T with connection socket M12, 5-pin

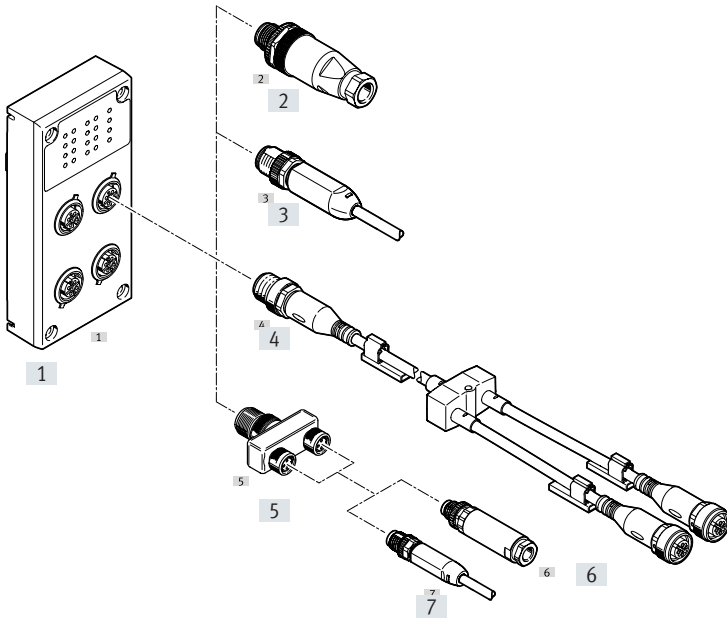

- Suitable for self-assembly and sturdy with 2 channels per connection
- 4 sockets
- 5-pin design per connection
- With two channels per connection, the corresponding input signals can be easily connected via a T-adapter and conventional cables with M8 connection.

CPX-M-AB-8-M12X2-5POL and CPX-AB-8-M12X2-5POL with connection socket M12, 5-pin

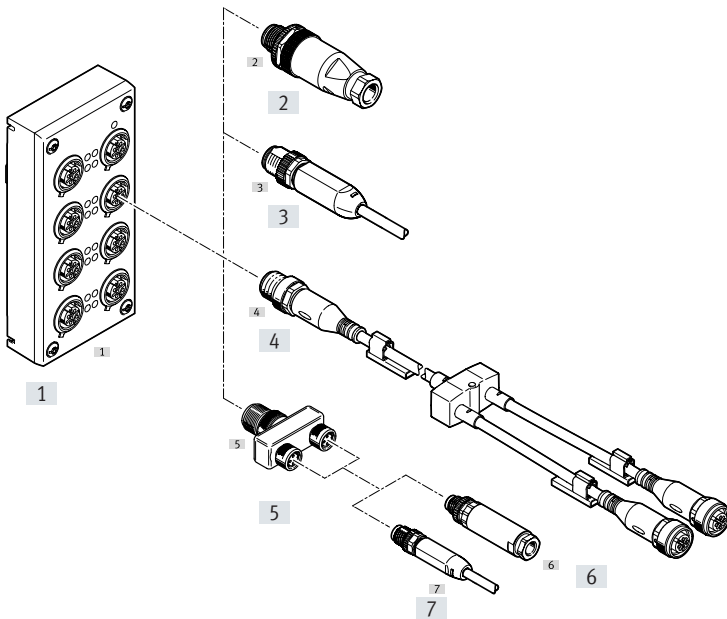

- Suitable for self-assembly and sturdy with 2 channels per connection
- 8 sockets
- 5-pin design per socket
- With two channels per connection, the corresponding input signals can be easily connected via a T-adapter and conventional connecting cables with M8 connection.

Note

Max. 4 T-adapters (NEDY) can be mounted on a connection block.

Key features – Electrical components

Combination of connection block and electrical connection technology					
Connection block	Connection technology	Plug connector/connecting cable	Connection technology	Plug connector/connecting cable	Connection technology
[1] CPX-M-AB-4-M12X2-5POL CPX-M-AB-4-M12X2-5POL-T CPX-M-AB-8-M12X2-5POL CPX-AB-8-M12X2-5POL	Socket M12, 5-pin	[2] NECB-S-M12G4-C2	Screw terminals	–	–
		[2] NECB-S-M12G5-C2	Screw terminals	–	–
		[2] NECB-S-M12G4-C2-D	Screw terminals, for two cables	–	–
		[2] NECB-S-M12G5-C2-D	Screw terminals, for two cables	–	–
		[3] NEBA-...-M12G5 (Modular system for choice of connecting cables)	Socket, M8, 4-pin Socket M12, 5-pin Open cable end	– – –	– – –
		[4] NEDY-... (modular system for all types of sensor/ actuator distributor)	2x socket, M8, 3-pin 2x socket, M8, 4-pin 2x socket, M12, 5-pin 2x socket, type A 2x socket, type B 2x socket, type C 2x socket, plug pattern H 2x socket, plug pattern ZB 2x socket, plug pattern ZC 2x open cable end	– – – – – – – – – –	– – – – – – – – – –
		[5] NEDY-L2R1-V1-M8G3-N-M12G4 (T-adapter)	Plug M12, 4-pin to 2x socket, M8, 3-pin	[6] NECB-S-M8G3-C2 [7] NEBA-...-M8G3 (Modular system for choice of connecting cables)	Screw terminals Socket, M8, 3-pin Socket, M8, 4-pin Socket M12, 5-pin Open cable end
		[5] NEDY-L2R1-V1-M12G5-N-M12G4 (T-adapter)	Plug M12, 4-pin to 2x socket, M12, 5-pin	[6] NECB-S-M12G4-C2 [6] NECB-S-M12G5-C2 [6] NECB-S-M12G4-C2-D [6] NECB-S-M12G5-C2-D [7] NEBA-...-M12G5 (Modular system for choice of connecting cables)	Screw terminals Screw terminals Screw terminals, for two cables Screw terminals, for two cables Socket, M8, 4-pin Socket M12, 5-pin Open cable end

Key features – Electrical components

Electrical connection – Connection block

CPX-AB-4-M12-8POL with connection socket M12, 8-pin

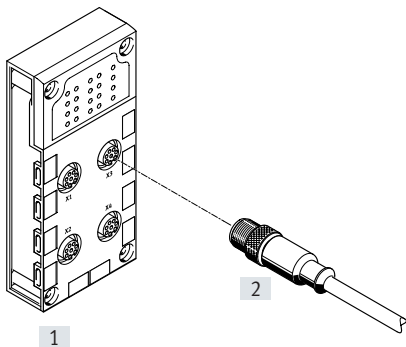

- Connection to cylinder/valve combinations with max. 3 inputs and 2 outputs
- 4 sockets
- 8-pin design per socket

Combination of connection block and electrical connection technology

Connection block	Connection technology	Plug connector/connecting cable	Connection technology
[1] CPX-AB-4-M12-8POL	Socket, M12, 8-pin	[2] KM12-8GD8GS-2-PU (pre-assembled connecting cable)	Socket M12, 8-pin

CPX-AB-8-KL-4POL, CPX-2ZE2DA with spring-loaded terminal connection

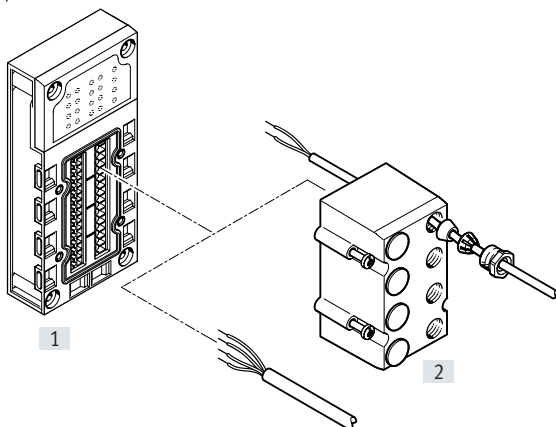

- Quick connection technology for use in control cabinets
- 32 spring-loaded terminals
- 4 spring-loaded terminals per channel
- Core cross-sections 0.05 ... 1.5 mm²
- Optional cover with fittings for IP65, IP67 connection
 - 8 through-holes M9
 - 1 through-hole M16
 - Blanking plug
 - For I/O distributors, control desks or individual sensors/actuators

Combination of connection block and electrical connection technology

Connection block	Connection technology	Plug connector/connecting cable	Connection technology
[1] CPX-AB-8-KL-4POL CPX-2ZE2DA	Spring-loaded terminals, 32-pin	[2] AK-8KL (cover)	–

Key features – Electrical components

Electrical connection – Connection block

CPX-AB-1-SUB-BU-25POL with Sub-D connection, 25-pin

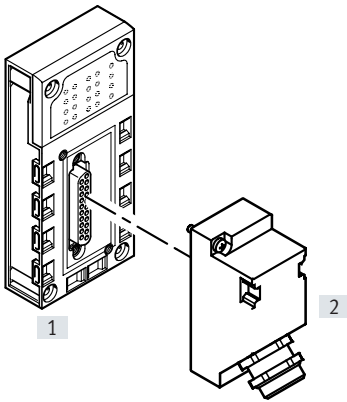

- Multi-pin connection for I/O distributor or control panel
- One socket
- 25-pin design

Combination of connection block and electrical connection technology

Connection block	Connection technology	Plug connector/connecting cable	Connection technology
[1] CPX-AB-1-SUB-BU-25POL	Socket, sub-D, 25-pin	[2] SD-SUB-D-ST25	Crimp contacts

Key features – Mounting

Hood

Description

→ page 234

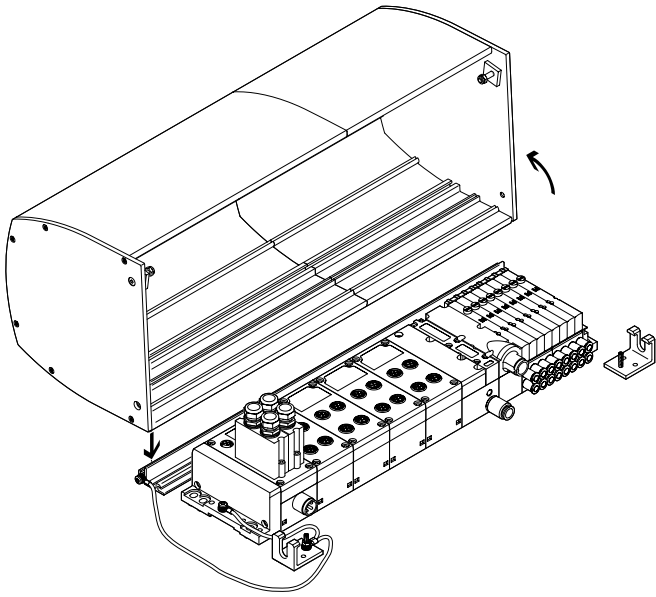

The CPX hood CAFC is a space- and cost-saving alternative to a control cabinet.

It is designed as an extruded aluminium profile and is installed on a mounting plate.

The valve terminal (CPX with MPA-S or MPA-L) is well protected and is quick to install without the need for complex cabinet through-feed for connecting cables and tubing.

The rail and the two mounting brackets are mounted on a base plate. The hood is attached to the retaining rail and secured with two screws. There is also a stand-by position (detent of the hood in the open position).

The hood is locked using two side screws (which meet the requirements for a special fastener in compliance with ATEX).

The CPX hood can be ordered online using the valve terminal configurator.

Advantages of the CPX hood

- Impact protection (min. 7 J) for the modules underneath in combination with a suitable mounting plate provided by the user
- Protection against electrostatic discharge by using electrically conductive materials and the option of connecting an earth wire
- Protection against disconnection of live plug connectors (by securing the hood with at least one special fastener to EN 60079-0, 9.2 and 20)
- UV protection for the CPX and MPA modules underneath

Points to note when using the CPX hood

- Only in combination with valve terminal MPA-S and MPA-L
- No bus nodes with push-pull connection (CPX-M-FB45)
- CPX power supply via angled plugs, no T plugs, no push-pull
- Electrical supply plate/additional supply only possible with angled plug
- No MPA vertical stacking
- Larger push-in fittings (for tubing O.D. larger than 12 mm) can only be used with the angled version
- Ducted exhaust air only with elbow connector
- The permissible ambient temperature range of the valve terminal is reduced by 5 °C.

-  - **Note**

The CPX hood has no influence on the ATEX classification of the valve terminal or of the CPX terminal.

The CPX hood has no influence on the IP degree of protection of the valve terminal or of the CPX terminal.

The CPX hood does not protect against the effects of the weather in installations that are not in enclosed spaces.

Key features – Mounting

Hood

Assembly

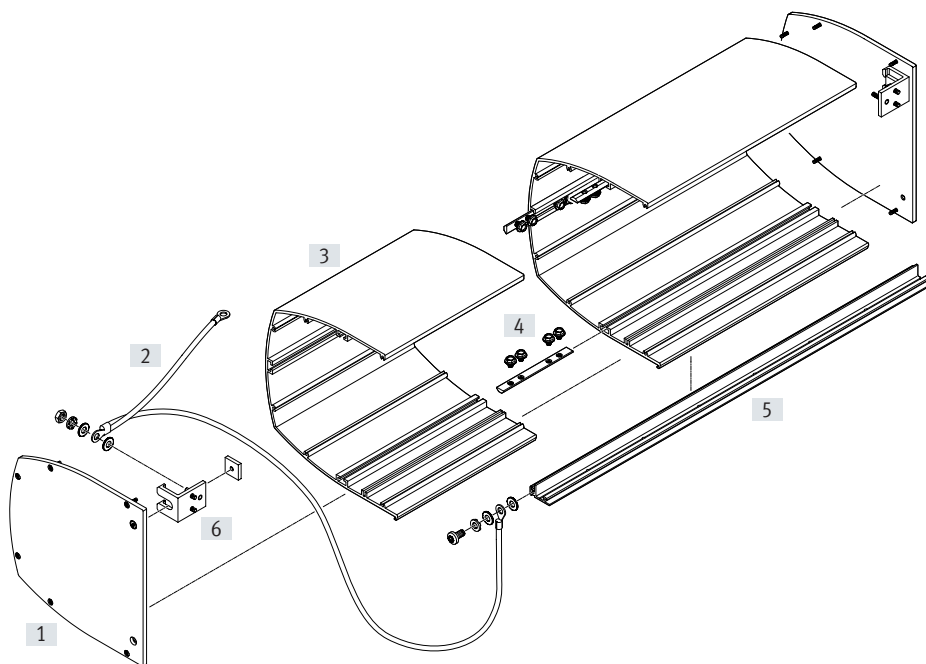

Procedure:

- Assemble the rail and mounting bracket included in the mounting kit
- Attach the earthing cable
- Assemble the hood (if applicable, screw together several hood sections and attach the side covers)
- Attach and secure the hood

- [1] Side cover
- [2] Earthing cable
- [3] Hood section
- [4] Slot nut with screws, for joining the hood sections
- [5] Rail
- [6] Mounting bracket

Technical data

Weight:

- Hood: approx. 500 g per 100 mm of length
- Mounting rail: approx. 550 g per 1000 mm of length
- Side pieces: approx. 500 g per side

- Ambient temperature $-5 \dots +50 \text{ }^{\circ}\text{C}$
- RoHS-compliant

Key features – Mounting

Extension

Operating principle

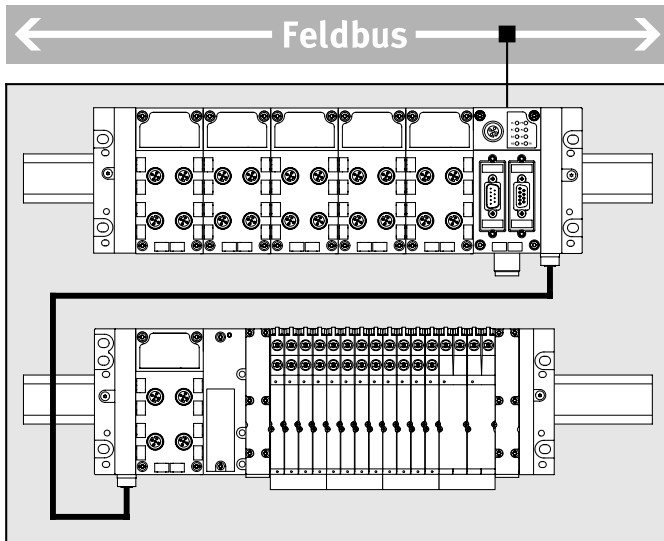

The extension enables the CPX terminal to be separated into or configured as two interconnected units (series). The two parts are controlled by a common bus node or control block. A comprehensive CPX terminal can fit into limited installation spaces more easily than two more compact units.

Applications:

- Installation in a control cabinet on two levels, one beneath the other
- Installation in two separate control cabinets
- Installation of part of the CPX terminal inside and part outside the control cabinet
- Spatial separation of electrics and pneumatics

Performance limits

- A maximum of 10 CPX modules can be installed in the first row
 - A maximum of 8 CPX modules and a pneumatic interface can be installed in the second row
- The number of CPX modules and solenoid coils is also limited by:
- the address space made available by the control block/bus node
 - their address requirement
 - their current consumption

Optimisation

- The maximum possible performance or maximum number of modules can only be achieved if the following conditions are observed:
- The control block/bus node is installed in the first row, on the far right, on an interlinking block with system supply
 - The connecting cable between the first and second row is max. 2 m long
 - An interlinking block with additional supply for valves is situated in the second row

Configuration rules

- The extension limits the power supply for the sensors and electronics for the CPX terminal as a whole as follows:
- First row max. 6 A
 - Second row max. 2 A
 - First and second row together, max. 6 A
- When using the 3 m connecting cable, the following restrictions apply:
- There can only be one CPX module in the second row
 - An additional supply for valves is required in order to connect a valve terminal
- When positioning output modules in the second row, a corresponding power supply in the second row is required:
- Install an interlinking block with additional supply for outputs in the second row to the left of the first output module

Key features – Mounting

Extension – Permissible CPX modules			
	Type	First row	Second row
Control blocks	CPX-CEC	Permissible, at least one control block or bus node required	Not permissible
Bus node	CPX-FB CPX-M-FB	Permissible, at least one control block or bus node required	Not permissible
Gateway	CPX-IOT	Not permissible	Not permissible
Technology modules	CPX-CP CPX-CTEL CPX-CTEL-2 CPX-CM-HPP CPX-CMAX CPX-CMPX CPX-CMIX	Permissible	Not permissible
Input/output modules	CPX	Permissible	Permissible
PROFIsafe shut-off module	CPX-FVDA-P2	Not permissible	Not permissible
Interlinking block/end plate with system supply	CPX-EPL-EV-S CPX-GE-EV-S CPX-M-GE-EV-S	Permissible, at least one interlinking block/end plate with system supply required	Not permissible
Interlinking block with additional supply	CPX-GE-EV-Z CPX-M-GE-EV-Z CPX-GE-EV-V	Permissible	Permissible
Interlinking block without power supply	CPX-GE-EV CPX-M-GE-EV	Permissible	Permissible
Interlinking block with system forwarding	CPX-M-GE-EV-W	Not permissible	Not permissible
Pneumatic interface	VMPA-FB	Not permissible	Permissible
	VMPAL-EPL-CPX	Not permissible	Permissible
	VABA-S6-1	Not permissible	Permissible
	VABA-S6-1...CB	Not permissible	Not permissible

Key features – Mounting

Extension – Maximum number of CPX modules/solenoid coils	First row	Second row
Special features of the design		
CPX terminal with valve terminal		
Connecting cable 3 m	10 CPX modules	Valve terminal MPA-S with: <ul style="list-style-type: none"> • Pneumatic interface for CPX metal interlinking module • Electrical supply plate VMPA-FB-SP directly after the pneumatic interface • Electronics modules with galvanic isolation • 128 solenoid coils (64 valve positions) Valve terminal VTSA/VTSA-F with: <ul style="list-style-type: none"> • 1 CPX module with interlinking block with additional supply for valves • 32 solenoid coils (32 valve positions)
CPX terminal without valve terminal		
• Control block/bus node not in position on the far right of the first row	10 CPX modules	• 2 ... 5 CPX modules, depending on the control block/bus node used
• Control block/bus node in position on the far right of the first row	10 CPX modules	• 4 ... 8 CPX modules, depending on the control block/bus node used
CPX terminal with valve terminal MPA-S		
–	10 CPX modules	• 2 ... 5 CPX modules and connection blocks MPA-S, depending on the control block/bus node used
• Electrical supply plates VMPA-FB-SP • Electronics modules with galvanic isolation	10 CPX modules	• 2 ... 5 CPX modules, depending on the control block/bus node used • Up to 128 solenoid coils (64 valve positions)
• Control block/bus node in position on the far right of the first row • CPX-FB11 or CPX-CEC not possible	10 CPX modules	• 4 ... 5 CPX modules and connection blocks MPA-S, depending on the control block/bus node used
• CPX-FB13 or CPX-FB36 • Control block/bus node in position on the far right of the first row • Interlinking block with system supply in position on the far right of the first row	10 CPX modules	• 8 CPX modules and connection blocks MPA-S
• CPX-FB13 or CPX-FB36 • Control block/bus node in position on the far right of the first row • Interlinking block with additional supply for valves in position on the far right of the first row	10 CPX modules	• 8 CPX modules and connection blocks MPA-S
• CPX-FB13 or CPX-FB36 • Control block/bus node in position on the far right of the first row • Interlinking block with additional supply for valves in second row	10 CPX modules	• 8 CPX modules and connection blocks MPA-S

Key features – Mounting

Extension – Maximum number of CPX modules/solenoid coils		
Special features of the design	First row	Second row
CPX terminal with valve terminal MPA-L		
–	10 CPX modules	<ul style="list-style-type: none"> • 2 CPX modules (at least one CPX module required) • 16 solenoid coils (valve widths 10 mm and 14 mm) or 8 solenoid coils (valve width 20 mm)
<ul style="list-style-type: none"> • Interlinking block with additional supply for valves in second row 	10 CPX modules	<ul style="list-style-type: none"> • 2 CPX modules (at least one CPX module required) • 32 solenoid coils (32 valve positions)
CPX terminal with valve terminal VTSA/VTSA-F		
–	10 CPX modules	<ul style="list-style-type: none"> • 2 CPX modules • 12 solenoid coils (valve widths 18 mm, 26 mm and 42 mm) or 6 solenoid coils (valve widths 52 mm and 65 mm)
<ul style="list-style-type: none"> • Interlinking block with additional supply for valves in second row 	10 CPX modules	<ul style="list-style-type: none"> • 2 CPX modules • 32 solenoid coils (32 valve positions)

Key features – Mounting

Mounting options

The valve terminals with CPX terminal support different mounting types for direct machine mounting with a high degree of protection and control cabinet installation.

DIN rail mounting

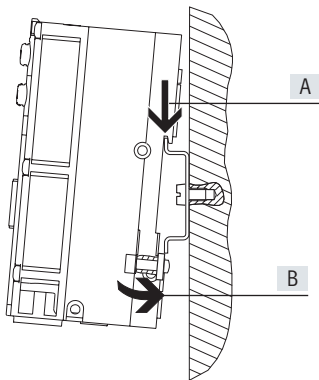

The DIN rail mounting is part of the rear profile of the CPX interlinking blocks. The CPX terminal can be attached to the DIN rail using the DIN rail mounting kit. The CPX terminal is first hooked onto the DIN rail (see arrow [A]),

then swivelled onto the DIN rail and secured in place with the clamping element (see arrow [B]). The optional earthing plate enables a connection to be established to the machine potential/earth in one easy step.

The following mounting kit is needed for DIN rail mounting:

- CPX-CPA-BG-NRH
- This enables the CPX terminal to be mounted on DIN rails in accordance with EN 60715. An additional mounting kit may be required for combination with valve terminals.

Wall mounting

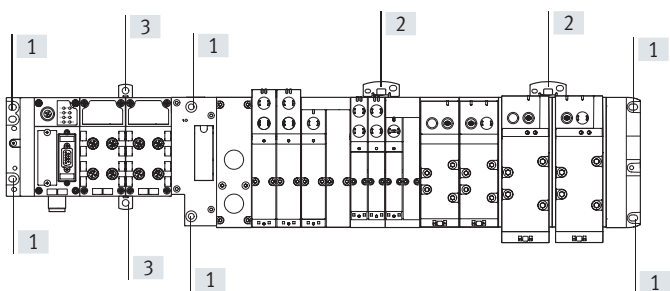

The end plates of the CPX terminal, the valve terminal and the pneumatic interface include mounting holes [1] for wall mounting. Additional mounting components [2] for the CPX terminal are available for longer valve terminals. These mountings differ depending on the design of the CPX terminal (polymer or metal).

In the case of 4 and more interlinking blocks, additional wall mountings must be used every 100 ...150 mm:

- Type CPX-M-BG-RW (metal design). These wall mountings are screwed in at the top on the CPX module.
- Type CPX-BG-RW (polymer design). These wall mountings are hooked in at the top and bottom between the CPX modules.

Key features – Mounting

CPX terminal in polymer design

Additional mountings

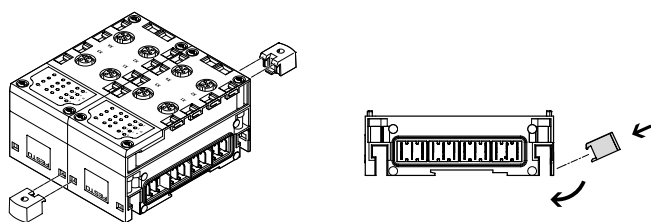

There are additional mounting components for the CPX terminal that can be fitted between two modules for longer valve terminals.

Note

For CPX terminals with 4 or more interlinking blocks: you need additional mounting components of type CPX-BG-RW every 100 or 150 mm. These are supplied pre-assembled.

Interlinking with tie rods

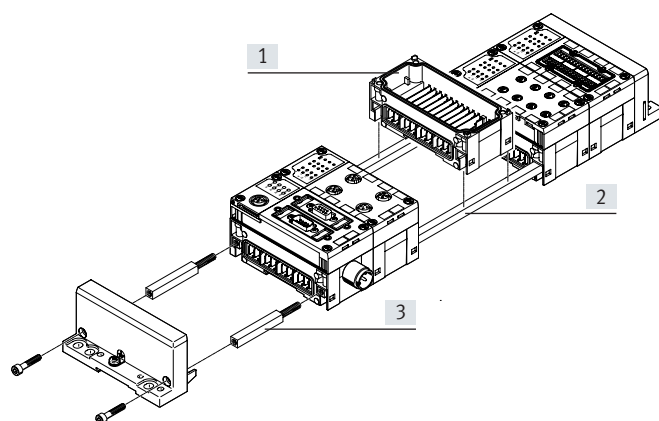

The mechanical connection between the CPX modules is created using special tie rods [2]. The entire unit can be assembled using two screws in the end plates.

The tie rod ensures that the unit has a high mechanical load-bearing capacity and is therefore the mechanical “backbone” of the CPX terminal.

The open design allows interlinking blocks [1] to be replaced when already mounted.

With the tie rod extension kit [3] an extra module can be added to the CPX terminal.

CPX terminal in metal design

Additional mountings

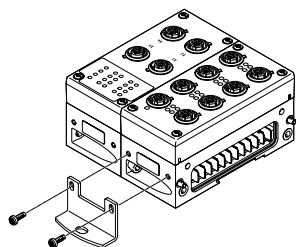

Additional mounting brackets for the CPX terminal that can be screwed onto the interlinking blocks are available for longer valve terminals.

The mounting bracket CPX-M-BG-VT-2X enables a CPX terminal with valve terminal VTSA/VTSA-F/VTSA-F-CB to be mounted on a support system.

Note

In the case of CPX terminals with 4 or more interlinking blocks, additional mounting brackets of the type CPX-M-BG-RW must be used every 100 or 150 mm. These are supplied pre-assembled.

Linking with screws

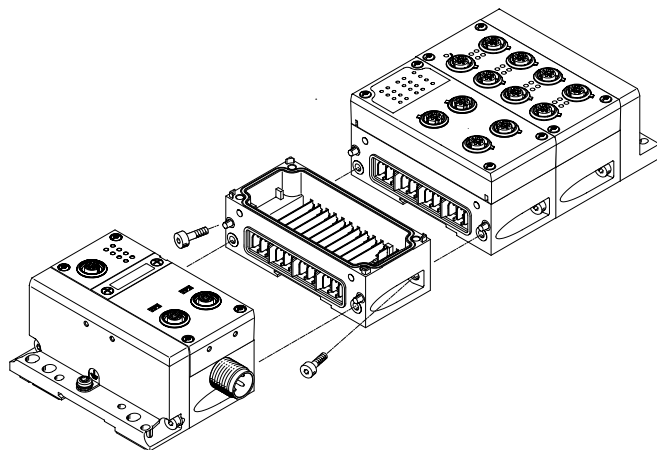

The CPX modules are mechanically connected using an angled fitting. The CPX terminal can thus be expanded at any time.

Key features – Power supply

Power supply concept

General

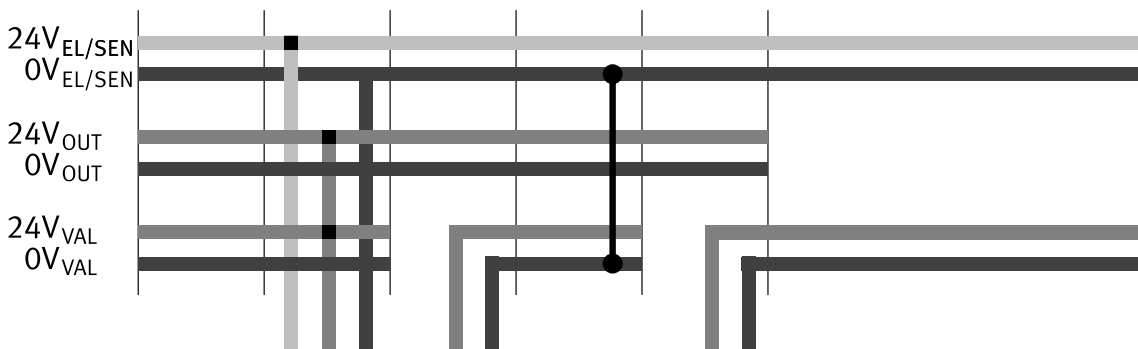
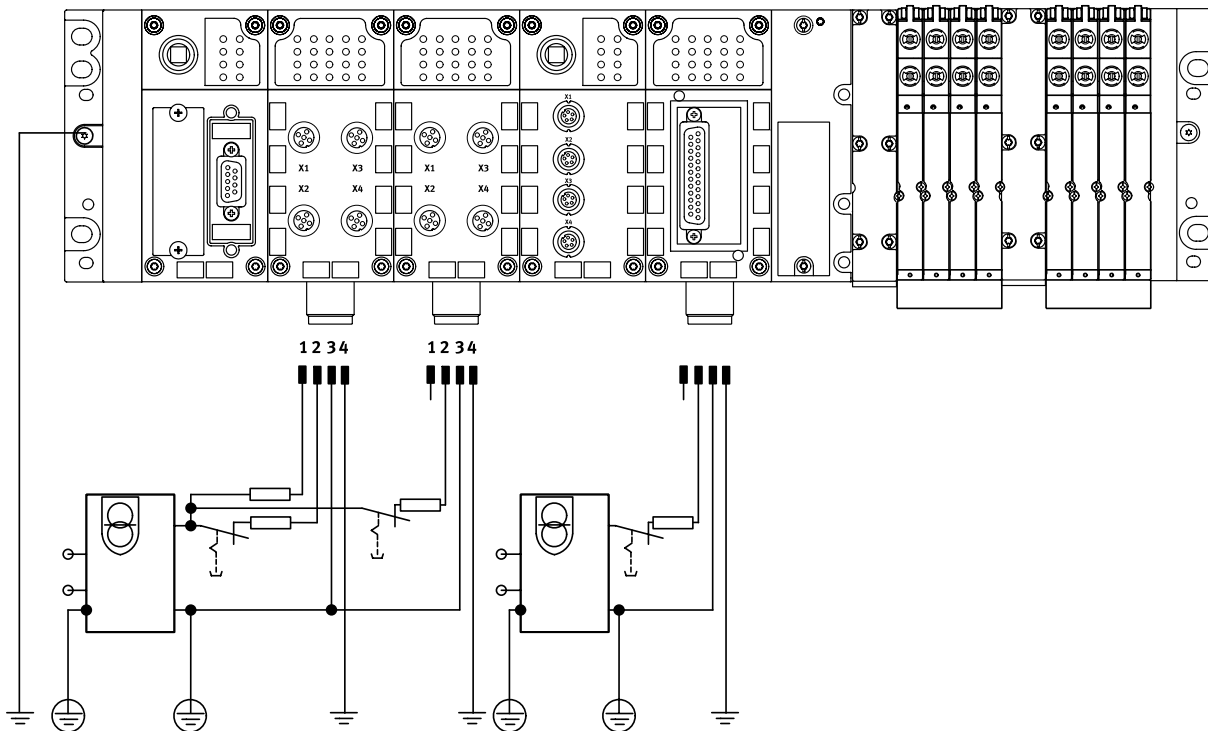

The use of decentralised devices on the fieldbus – particularly with a high degree of protection for direct mounting on the machine – requires a flexible power supply concept.

A valve terminal with CPX is, in principle, supplied with all voltages via a single connection.

A distinction is made between the supply for

- Electronics plus sensors
- Valves plus actuators

in this case.

Choice of connection technology:

- M18
- 7/8"
- M12x1
- AIDA push-pull

Interlinking blocks

Interlinking blocks represent the backbone of the CPX terminal with all supply lines. They provide the power supply for the modules used on them as well as their bus connections.

Many applications require the CPX terminal to be separated into voltage zones. This applies in particular to the separate disconnection of solenoid coils and outputs.

The interlinking blocks provide either an easy-to-install central power supply for the entire CPX terminal or galvanically isolated, all-pin disconnectable potential groups/voltage segments.

Key features – Power supply

Interlinking blocks

With system supply

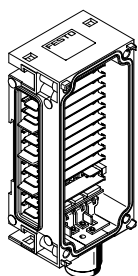

Polymer design

- CPX-GE-EV-S
- CPX-GE-EV-S-7/8-4POL
- CPX-GE-EV-S-7/8-5POL

Metal design

- CPX-M-GE-EV-S-7/8-CIP-4P
- CPX-M-GE-EV-S-7/8-5POL
- CPX-M-GE-EV-S-M12-5POL
- CPX-M-GE-EV-S-PP-5POL

Connection technology

- M18, 4 pin
- 7/8" 4-pin
- 7/8" 5-pin

Connection technology

- 7/8" 4-pin
- 7/8" 5-pin
- M12x1, L-coded, 5-pin
- AIDA push-pull, 5-pin

Power supply

- For CPX terminal modules and connected sensors
- For valves that are connected to the CPX terminal via a pneumatic interface
- For actuators that are connected to the output modules of the CPX terminal

Without power supply

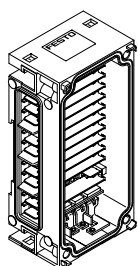

Polymer design

- CPX-GE-EV

Metal design

- CPX-M-GE-EV
- CPX-M-GE-EV-FVO

–

–

–

With additional supply for outputs

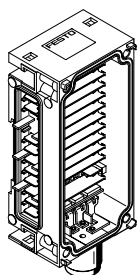

Polymer design

- CPX-GE-EV-Z
- CPX-GE-EV-Z-7/8-4POL
- CPX-GE-EV-Z-7/8-5POL

Metal design

- CPX-M-GE-EV-Z-7/8-5POL
- CPX-M-GE-EV-Z-PP-5POL

Connection technology

- M18, 4 pin
- 7/8" 4-pin
- 7/8" 5-pin

Connection technology

- 7/8" 5-pin
- AIDA push-pull, 5-pin

Power supply

- For actuators that are connected to output modules of the CPX terminal

With additional supply for valves

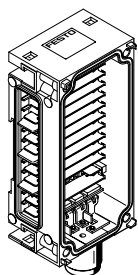

Polymer design

- CPX-GE-EV-V

Connection technology

- M18, 4 pin

Power supply

- For valves that are connected to the CPX terminal via a pneumatic interface

 **Note**

For 7/8":

- Commercially available accessories are often limited to max. 8 A

 **Note**

The valve terminal MPA-S has either a 7/8" 5-pin, 7/8" 4-pin, 3-pin M18 or 5-pin AIDA push-pull power supply for one or more valve voltage zones. Galvanically isolated, all-pin disconnectable with voltage monitoring in the following MPA module.

 **Note**

Suitable versions of the interlinking blocks with M18 and 7/8", 5-pin connection are available (CPX-GE-EV-...-VL and CPX-M-GE-EV-...-VL) for use in ATEX environments as per certification (→ page 48). The maximum current supply for these interlinking blocks is 8 A.

Key features – Power supply

Interlinking blocks

With system forwarding

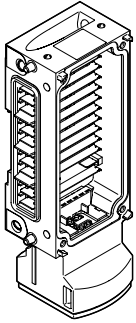

Metal design

- CPX-M-GE-EV-W-M12-5POL

Connection technology

- M12x1, L-coded, 5-pin

Voltage transmission

- For a further CPX terminal

Key features – Diagnostics

Diagnostics

System performance

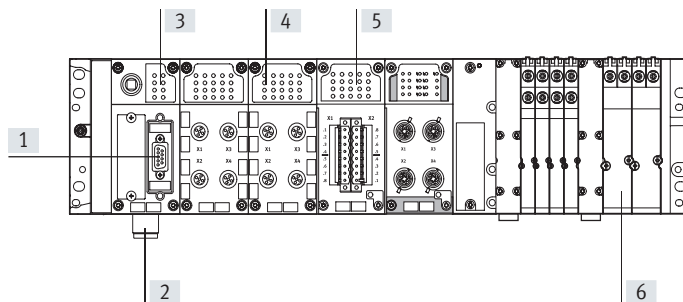

- [1] Diagnostics via bus interface
- [2] Undervoltage monitoring
- [3] Diagnostic overview LED
 - Fieldbus status
 - CPX status
- [4] Status and diagnostic LED for module and I/O channels
- [5] Module and channel-specific diagnostics
- [6] Valve-specific diagnostic module and solenoid coils
- [7] MPA pressure sensor – integrated solution on the fieldbus
 - Pre-assembled for channels 1, 3, 5 and external pressures

Detailed diagnostic functions are needed in order to quickly locate the causes of errors in the electrical installation and therefore reduce downtimes in production plants. A basic distinction is made between on-the-spot diagnostics using LEDs or a diagnostic interface and diagnostics using a bus interface.

The CPX terminal supports on-the-spot diagnostics via a row of LEDs. This is separate from the connection area and therefore provides good visual access to status and diagnostic information.

Module and channel-specific diagnostics are supported, for example:

- Undervoltage detection for outputs and valves
- Short-circuit detection for sensors, outputs and valves
- Open-load detection for a missing solenoid coil
- Storage of the last 40 causes of errors with error start and error end

The diagnostic messages can be read out via the bus interface in the higher-order controller and visualised for the central recording and evaluation of error causes. This is done using the individual fieldbus-specific channels. CPX-CECs also offer the option of access via the integrated Ethernet interface (remote maintenance via PC/web applications).

Overview of LEDs on the bus node

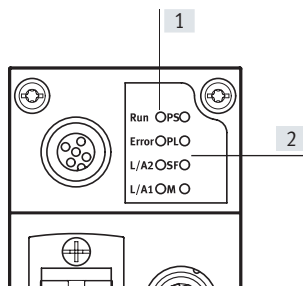

[1] Fieldbus-specific LEDs

On each bus node, a maximum of 4 fieldbus-specific LEDs indicate the fieldbus communication status of the CPX terminal with the higher-order controller.

[2] CPX-specific LEDs

A further 4 CPX-specific LEDs provide non-fieldbus-specific information about the status of the CPX terminal, for example:

- Power system
- Power load
- System error
- Modify parameters

Input/output module status and diagnostic LEDs

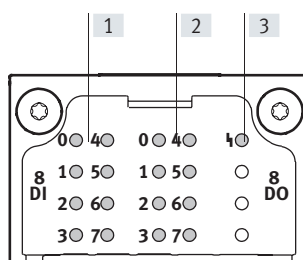

[1] Status LEDs for the inputs and outputs
Each input and output channel is assigned a status LED.

[2] Channel-related diagnostic LEDs
Depending on the module design, another diagnostic LED is available for each I/O channel

[3] Group diagnostic LEDs
An LED indicates the group diagnostics for each module

Key features – Diagnostics

Diagnostics

Display on a PC

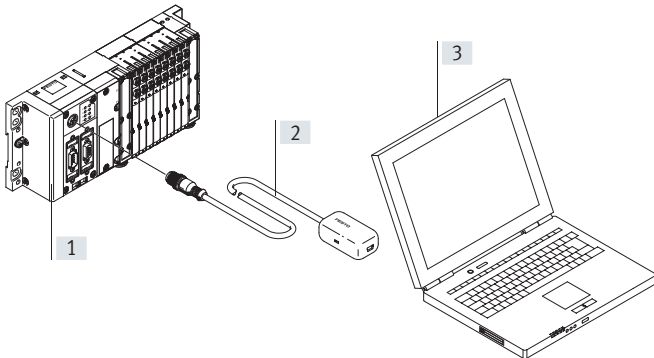

- [1] CPX terminal with valve terminal
- [2] Adapter diagnostic interface to USB
- [3] Laptop/portable device with USB interface and installed FMT software
 - Error location and type
 - Without programming
 - Storing the configuration
 - Preparing screenshots

Data gathering via gateway

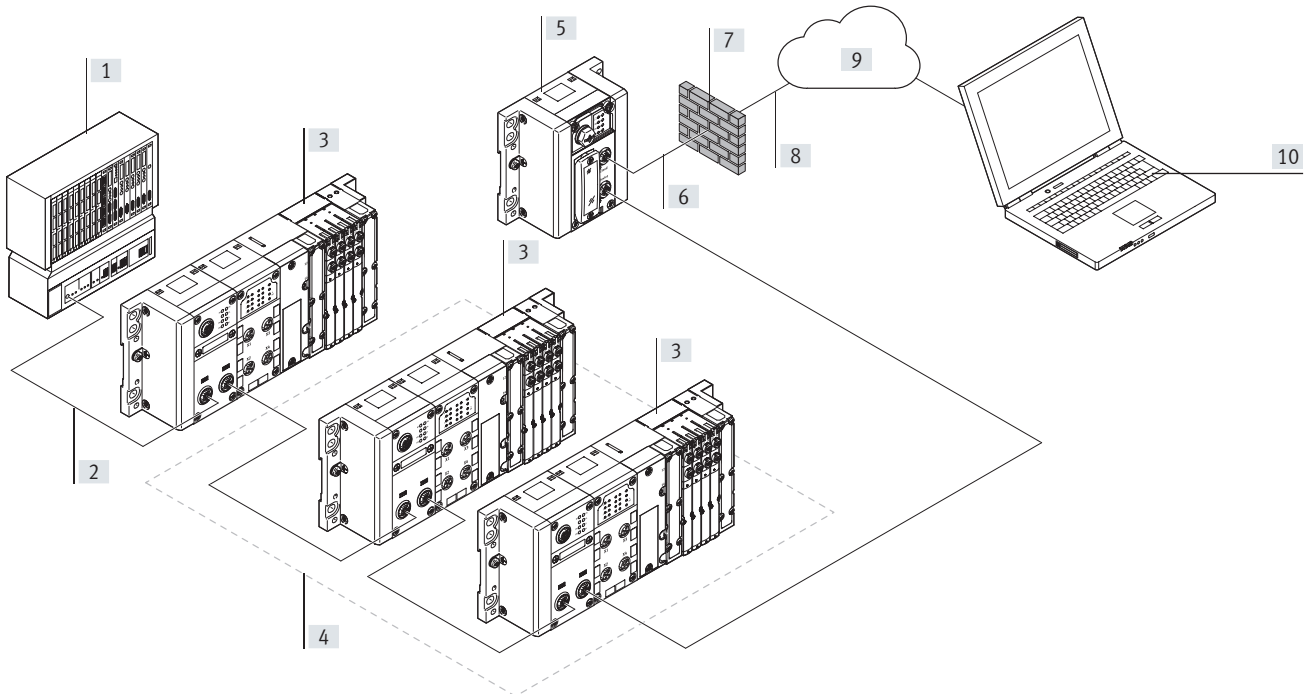

- [1] PLC to machine/system controller (no direct internet connection)
- [2] Bus system from the controller to the system parts (e.g. PROFINET)
- [3] Festo components with bus connection with serial links
- [4] Components from which the CPX-IOT is collecting and transferring data
- [5] Gateway CPX-IOT
- [6] Internet connection
- [7] Customer firewall or other security precautions
- [8] Transferring data to a central storage location (MQTT broker) using secure protocols
- [9] Central storage (customer's MQTT broker)
- [10] Simple decentralised evaluation of data using adapted programs (apps) for the components that are being monitored

Key features – Parameterisation

Parameterisation

Changes to the application are often required during commissioning. The parameterisable characteristics of the CPX modules mean that functions can be very easily changed using configuration software. This reduces the number of modules needed and, consequently, the amount of storage space required.

It is therefore possible, for example, to reduce the input debounce time for an input module – normally 3 ms – to 0.1 ms on a "fast" input module for faster processes, or to set the response of a valve following a fieldbus interruption.

Depending on the modules used, parameterisation can be carried out via the following interfaces:

- Ethernet
- Fieldbus
- Control block direct interface (programming interface)

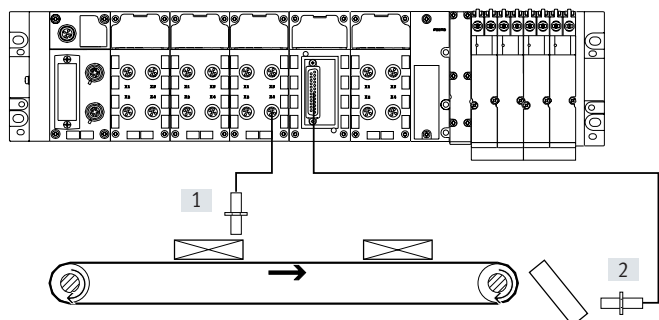

- [1] Input debounce time 3 ms
[2] Input debounce time 0.1 ms

Key features – Addressing

Addressing

The various CPX modules occupy a different number of I/O addresses within the CPX system. The maximum address space for bus nodes depends on the performance of the fieldbus systems.

Maximum system configuration:

- 1 bus node or control block
- 9 I/O modules
- 1 pneumatic interface (e.g. pneumatic interface MPA-S with up to 16 MPA connection blocks)

The maximum system configuration can be limited in individual cases by exceeding the address space.



Note

Please refer to the detailed description of the configuration/addressing rules in the technical data for CPX bus nodes.

Overview – Address space for CPX bus node and control block

	Protocol	Max. total		Max. digital		Max. analogue	
		Inputs	Outputs	Inputs	Outputs	Inputs	Outputs
CPX-CEC	<ul style="list-style-type: none"> • CODESYS Level 2 • TCP/IP • Easy IP • Modbus TCP 	512 bit	512 bit	512 DI	512 DO	32 AI	18 AO
CPX-FB11	DeviceNet®	512 bit	512 bit	512 DI	512 DO	32 AI	18 AO
CPX-FB13	PROFIBUS	512 bit	512 bit	512 DI	512 DO	32 AI	18 AO
CPX-FB23-24	CC-LINK®	512 bit	512 bit	512 DI	512 DO	32 AI	18 AO
CPX-FB36	EtherNet/IP	512 bit	512 bit	512 DI	512 DO	32 AI	18 AO
CPX-FB37	EtherCAT®	512 bit	512 bit	512 DI	512 DO	32 AI	18 AO
CPX-FB39	Sercos III	512 bit	512 bit	512 DI	512 DO	32 AI	18 AO
CPX-FB40	POWERLINK	512 bit	512 bit	512 DI	512 DO	32 AI	18 AO
CPX-FB43	PROFINET RT	512 bit	512 bit	512 DI	512 DO	32 AI	18 AO
CPX-M-FB44	PROFINET RT	512 bit	512 bit	512 DI	512 DO	32 AI	18 AO
CPX-M-FB45	PROFINET RT	512 bit	512 bit	512 DI	512 DO	32 AI	18 AO



Note

The bandwidth of the bus nodes can be restricted by the choice of module and the maximum number of modules.

Example of CPX-FB43 (PROFINET RT)

	Digital inputs	Digital outputs	Remarks
1x CPX-CM-HPP	256	256	<ul style="list-style-type: none"> • The address space is occupied by 7 CPX I/O modules plus pneumatic interface • No additional modules can be configured
2x CPX-2ZE2DA	192	192	
4x CPX-16DE	64	–	
8x VMFA1	–	64	
Assigned address space	512	512	

DI = Digital inputs (1 bit)

DO = Digital outputs (1 bit)

AO = Analogue outputs (16 bits)

AI = Analogue inputs (16 bits)

Key features – Addressing

Overview – Allocated addresses for CPX modules		
	Inputs [bit]	Outputs [bit]
CPX-CP-4-FB	16, 32, 48, 64, 80, 96, 128 ¹⁾	16, 32, 48, 64, 80, 96, 128 ¹⁾
CPX-CTEL-4-M12-5POL	0, 64, 128, 192, 256 ¹⁾	0, 64, 128, 192, 256 ¹⁾
CPX-CTEL-2-M12-5POL-LK	64, 128, 192, 256 ¹⁾	64, 128, 192, 256 ¹⁾
CPX-CM-HPP	256	256
CPX-CMAX-C1-1	64	64
CPX-CMPX-C-1-H1	48	48
CPX-CMIX-M1-1	48	48
CPX-4DE	4	–
CPX-8DE	8	–
CPX-8DE-D	8	–
CPX-8NDE	8	–
CPX-F8DE-P	48	56
CPX-16DE	16	–
CPX-M-16DE-D	16	–
CPX-L-16DE-16-KL-3POL	16	–
CPX-4DA	–	4
CPX-8DA	–	8
CPX-8DA-H	–	8
CPX-8DE-8DA	8	8
CPX-L-8DE-8DA-16-KL-3POL	8	8
CPX-2ZE2DA	96	96
CPX-2AE-U-I	2 x 16	–
CPX-4AE-U-I	4 x 16	–
CPX-4AE-I	4 x 16	–
CPX-4AE-P-B2	4 x 16	–
CPX-4AE-P-D10	4 x 16	–
CPX-4AE-T	4 x 16	–
CPX-4AE-TC	4 x 16	–
CPX-2AA-U-I	–	2 x 16
CPX-FVDA-P2	48	48
VMPA1-FB-EMS-8	–	8
VMPA1-FB-EMG-8	–	8
VMPA2-FB-EMS-4	–	4
VMPA2-FB-EMG-4	–	4
VMPA1-FB-EMS-D2-8	–	8
VMPA1-FB-EMG-D2-8	–	8
VMPA2-FB-EMS-D2-4	–	4
VMPA2-FB-EMG-D2-4	–	4
VMPA-FB-PS-1	16	–
VMPA-FB-PS-3/5	16	–
VMPA-FB-PS-P1	16	–
VMPA-FB-EMG-P1	16	16
VMPAL-EPL-CPX	–	4, 8, 16, 24, 32 ¹⁾
VABA-S6-1-X1	–	8, 16, 24, 32 ¹⁾
VABA-S6-1-X2	–	8, 16, 24, 32 ¹⁾
VABA-S6-1-X2-D	8, 16, 24, 32 ¹⁾	8, 16, 24, 32 ¹⁾
VABA-S6-1-X1-CB	–	8, 16, 24 ¹⁾
VABA-S6-1-X2-CB	–	8, 16, 24 ¹⁾
VABA-S6-1-X2-F1-CB	–	8, 16, 24 ¹⁾
VABA-S6-1-X2-F2-CB	–	8, 16, 24 ¹⁾
VABA-S6-1-X1-3V-CB	–	8, 16, 24 ¹⁾
VABA-S6-1-X2-3V-CB	–	8, 16, 24 ¹⁾

1) Dependent on the DIL switch setting on the module

Datasheet

 Module width
50 mm

 Repair service



 **Note**

The data given here apply to the CPX system. If components that conform to lower values are used in the system, the specification for the entire system is reduced to the values for those components.

Example

Degree of protection IP65/IP67 applies only to the fully assembled system with fitted plugs or covers (which must also conform to IP65/IP67).

If components with a lower degree of protection are used, the protection level of the entire system is reduced to the degree of protection of the component with the lowest degree of protection, for example CageClamp connection block with degree of protection IP20 or MPA pneumatics with degree of protection IP65.

General technical data		
Module no.		197330
Max. number of modules ¹⁾	Control block	1
	Bus node	1
	I/O modules/CP interface/CTEL interface/electrical interface CPX-CTEL-2/multi-axis interface	9
	Pneumatic interface	1
Max. address capacity	Inputs [byte]	64
	Outputs [byte]	64
Internal cycle time	[ms]	< 1
Configuration support		Fieldbus-specific
LED indicators	Bus node/control block/gateway	Up to 4 LEDs, bus-specific 4 LEDs, CPX-specific • PS = Power system • PL = Power load • SF = System error • M = Modify parameter/forcing active
	I/O modules	Min. one group diagnostic LED Channel-oriented status and diagnostic LED, depending on the module
	Pneumatic interface	One group diagnostic LED Valve status LED on valve
Diagnostics		<ul style="list-style-type: none"> • Channel- and module-orientated diagnostics for inputs/outputs and valves • Detecting the module undervoltage for the different potential values • Storage of the last 40 errors with timestamp (acyclic access)

¹⁾ A maximum of 11 modules in total can be combined.
(e.g. 1 control block + 9 I/O modules + 1 pneumatic interface, or 1 control block + 1 bus node + 8 I/O modules + 1 pneumatic interface)

Datasheet

General technical data			
Module no.		197330	
Parameterisation		Diagnostic behaviour	
		Fail-safe response	
		Forcing of channels	
		Signal setup	
Commissioning support		Forcing of inputs and outputs	
Degree of protection to EN 60529		IP65, IP67	
Nominal operating voltage	[V DC]	24	
Operating voltage range	[V DC]	18 ... 30	
Power supply	Interlinking block with system supply Electronics plus sensors Actuators plus valves	[A] [A]	16 (8/10 with 7/8" supply, 5-pin/4-pin) 16 (8/10 with 7/8" supply, 5-pin/4-pin)
	Additional supply Actuators	[A] [A]	16 (8/10 with 7/8" supply, 5-pin/4-pin)
	Additional power supply for valves	[A]	16 (10 with 7/8" supply, 4-pin)
Current consumption		Depending on the system configuration	
Power failure buffering (bus electronics only)	[ms]	10	
Power supply connection		M18, 4 pin	
		7/8" 5-pin	
		7/8" 4-pin	
		AIDA push-pull, 5-pin	
Fuse concept		Per module with electronic fuses	
Tests	Vibration test to DIN IEC 68		<ul style="list-style-type: none"> • With wall mounting: severity level 2 • With DIN rail mounting: severity level 1
	Shock test to DIN IEC 68		<ul style="list-style-type: none"> • With wall mounting: severity level 2 • With DIN rail mounting: severity level 1
LABS (PWIS) conformity		VDMA24364-B2-L	
Immunity to interference		EN 61000-6-2 (industry)	
Interference emission		EN 61000-6-4 (industry)	
Isolation test for galvanically isolated circuits to IEC 1131 Part 2	[V DC]	500	
Galvanic isolation of electrical voltages	[V DC]	80	
Protection against direct and indirect contact		PELV	
Materials		End plates: Die-cast aluminium	
Grid dimension	[mm]	50	
Operating and environmental conditions			
Module no.		197330	
Ambient temperature	[°C]	-5 ... +50	
Storage temperature	[°C]	-20 ... +70	

Datasheet

Certifications and approvals – Maximum values	
Module no.	197330
ATEX category for gas	II 3G
Type of (ignition) protection for gas	Ex ec IIC T4 Gc X
Explosion-proof ambient temperature [°C]	-5 ≤ Ta ≤ +50
CE marking (see declaration of conformity) ²⁾	To EU Explosion Protection Directive (ATEX)
	To EU EMC Directive ¹⁾
	To EU RoHS Directive
UKCA marking (see declaration of conformity) ²⁾	To UK explosion regulations
	To UK EMC regulations
	To UK RoHS regulations
KC marking	KC EMC
Degree of protection to EN 60529	IP65, IP67
Certification	c UL us - Recognized (OL)
	RCM
Explosion protection certification outside the EU	EPL Gc (Ru)
	EPL Gc (GB)

- 1) For information about the area of use, see the EC declaration of conformity at: www.festo.com/catalogue/... d Support/Downloads.
If the devices are subject to usage restrictions in residential, commercial or light-industrial environments, further measures for the reduction of the emitted interference may be necessary.
- 2) More information www.festo.com/catalogue/... → Support/Downloads.

 **Note**

The values indicated represent the maximum performance limits that can be achieved with the fully assembled product. Depending on the individual components used, the ac-

tual value achieved for the overall product may be lower. You can select e.g. the individual components required to achieve the ATEX category by choosing the corres-

ponding features in the online product configurator:
→ Internet:cpx

Datasheet





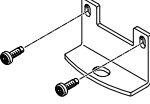
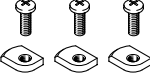
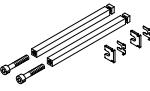
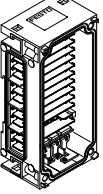
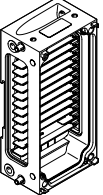

Weight [g]		
Control block	CEC	155
	CEC...V3	135
Bus node	FB11	120
	FB13	115
	FB23-24	115
	FB36	125
	FB37	125
	FB39	125
	FB40	125
	FB43	185
	FB44	280
FB45	280	
Gateway	IOT	130
I/O module	4 digital outputs	42
	4 digital inputs	39
	8 digital inputs	39
	8 digital inputs, positive logic (PNP), enhanced diagnostic function	45
	8 digital inputs, negative logic (NPN)	40
	16 digital inputs, internal electronic fuse per module	41
	16 digital inputs, internal electronic fuse per channel pair, for CPX in metal	46
	16 digital inputs, for CPX in polymer, including interlinking block and connection block with spring-loaded terminals	167
	8 digital inputs, 8 digital outputs	48
	8 digital inputs, 8 digital outputs, for CPX in polymer, including interlinking block and connection block with spring-loaded terminals	171
	8 digital outputs, power supply 0.5 A per channel	49
	8 digital outputs, power supply 2.1 A per channel pair	48
	2 analogue current or voltage inputs	48
	4 analogue current inputs	47
	2 analogue current or voltage outputs	49
	2 or 4 analogue temperature inputs	47
	4 analogue temperature inputs, with 2-conductor connection for a PT1000 sensor for cold junction compensation	46
4 analogue pressure inputs	115	
PROFIsafe	Shut-off module	50
	Input module	46
Counter module	2ZE2DA	130
CP interface	CP	139
CTEL interface	CTEL	110
Electrical interface	CTEL-2	110

Weight [g]		
Axis interface	CM-HPP	140
Axis controller	CMAx	140
End-position controller	CMPX	140
Measuring module	CMIX	140
Polymer connection block	8-way, M8 3-pin	62
	8-way, M8 4-pin	65
	4-way, M12 5-pin	60
	4-way, M12 5-pin, quick lock, shielded with metal thread	87
	8-way, M12 5-pin	76
	4-way, M12 8-pin	65
	Spring-loaded terminal, 32-pin	75
	Sub-D 25-pin	72
	8-way, DIL switch	57
Metal connection block	4-way, M12 5-pin	112
	4-way, M12 5-pin, pulsed sensor supply	110
	8-way, M12 5-pin	152
Polymer interlinking block	Without power supply	108
	System supply	125
Interlinking block, metal	Without power supply	169
	System supply, 7/8" 4-pin	228
	System supply, 7/8" 5-pin	187
	System supply, M12x1	279
	System supply, push-pull	279
	System forwarding, M12x1	279
Tie rods	1 valve	41
	2 valves	71
	3 valves	97
	4 valves	127
	5 valves	156
	6 valves	173
	7 valves	199
	8 valves	247
	9 valves	274
	10 valves	301
End plate for polymer design	Left	110
	Left, with system supply	145
	Right	110
End plate for metal design	Left	113
End plate with extension	Left	190
	Right	175
Pneumatic interface	MPA-S	238.4
	VTSA/VTSA-F	590
	VTSA-F-CB without voltage zones	560
	VTSA-F-CB with safe voltage zones	734
	VTSA-F-CB with safe voltage zones and power supply for external consuming devices	754
	VTSA-F-CB with external power supply	580

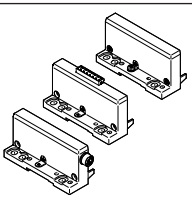
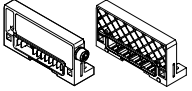
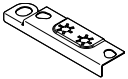
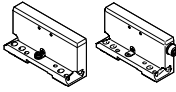
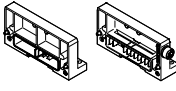

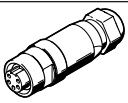
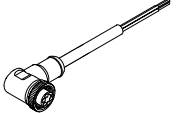

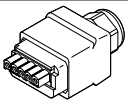
Datasheet

Ordering data – Accessories				
Designation		Part no.	Type	
Mounting				
	Attachment for wall mounting (for long valve terminals, pack of 10), design for polymer manifold sub-bases	529040	CPX-BG-RW-10x	
	Attachment for wall mounting, version for metal manifold sub-bases	2 mounting brackets, 4 screws	550217	CPX-M-BG-RW-2X
		1 mounting bracket, 2 screws	2721419	CPX-M-BG-VT-2X
	Mounting for DIN rail	CPX without pneumatic components	526032	CPX-CPA-BG-NRH
		CPX-VTSA		
		CPX-VTSA-F		
		CPX-MPA		
Tie rods				
	Tie rod CPX	Extension, 1 module	525418	CPX-ZA-1-E
		1 valve	195718	CPX-ZA-1
		2 valves	195720	CPX-ZA-2
		3 valves	195722	CPX-ZA-3
		4 valves	195724	CPX-ZA-4
		5 valves	195726	CPX-ZA-5
		6 valves	195728	CPX-ZA-6
		7 valves	195730	CPX-ZA-7
		8 valves	195732	CPX-ZA-8
		9 valves	195734	CPX-ZA-9
10 valves	195736	CPX-ZA-10		
Polymer interlinking block				
	Without power supply	–	195742	CPX-GE-EV
	With system supply	M18	195746	CPX-GE-EV-S
		M18, for ATEX environment	8022170	CPX-GE-EV-S-VL
		7/8" – 4-pin	541248	CPX-GE-EV-S-7/8-4POL
		7/8" – 5-pin	541244	CPX-GE-EV-S-7/8-5POL
		7/8" – 5-pin, for ATEX environment	8022172	CPX-GE-EV-S-7/8-5POL-VL
	With additional supply for outputs	M18	195744	CPX-GE-EV-Z
		7/8" – 4-pin	541250	CPX-GE-EV-Z-7/8-4POL
		7/8" – 5-pin	541246	CPX-GE-EV-Z-7/8-5POL
With additional supply for valves	M18	533577	CPX-GE-EV-V	
Interlinking block, metal				
	Without power supply	–	550206	CPX-M-GE-EV
		For CPX-FVDA-P2 only	567806	CPX-M-GE-EV-FVO
	With system supply	7/8" – 4-pin	568956	CPX-M-GE-EV-S-7/8-CIP-4P
		7/8" – 5-pin	550208	CPX-M-GE-EV-S-7/8-5POL
		7/8" – 5-pin, for ATEX environment	8022165	CPX-M-GE-EV-S-7/8-5POL-VL
		M12x1, L-coded, 5-pin	8098392	CPX-M-GE-EV-S-M12-5POL
		Push-pull – 5-pin	563057	CPX-M-GE-EV-S-PP-5POL
	With additional supply for outputs	7/8" – 5-pin	550210	CPX-M-GE-EV-Z-7/8-5POL
		Push-pull – 5-pin	563058	CPX-M-GE-EV-Z-PP-5POL
	With system forwarding	M12x1, L-coded, 5-pin	8098391	CPX-M-GE-EV-W-M12-5POL

Datasheet

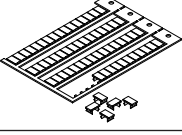
Ordering data – Accessories				
Designation			Part no.	Type
Mounting accessories				
	Screws for mounting the bus node/connection block on the polymer interlinking block	Bus node/metal connection block	550218	CPX-DPT-30X32-S-4X
	Screws for mounting the bus node/connection block on the metal interlinking block	Bus node/polymer connection block	550219	CPX-M-M3x22-4x
		Bus node/metal connection block	550216	CPX-M-M3x22-S-4x
End plates for polymer design				
	End plate, left	–	195716	CPX-EPL-EV
		With system supply	576315	CPX-EPL-EV-S
		With extension	576314	CPX-EPL-EV-X
	End plate, right	–	195714	CPX-EPR-EV
		With extension	576313	CPX-EPR-EV-X
	Earthing component for right/left end plate	Pack of 5	538892	CPX-EPFE-EV
End plates for metal design				
	End plate, left	–	550212	CPX-M-EPL-EV
		With extension	576317	CPX-M-EPL-EV-X
	End plate, right	–	550214	CPX-M-EPR-EV
		With extension	576316	CPX-M-EPR-EV-X
Power supply				
	Plug socket for mains connection M18x1, straight, 4-pin	For 1.5 mm ²	18493	NTSD-GD-9
		For 2.5 mm ²	18526	NTSD-GD-13,5
	Plug socket for mains connection M18x1, angled, 4-pin	For 1.5 mm ²	18527	NTSD-WD-9
		For 2.5 mm ²	533119	NTSD-WD-11
	Plug socket for mains connection 7/8", straight, 5-pin	0.25 ... 2.0 mm ²	543107	NECU-G78G5-C2
		0.25 ... 2.0 mm ²	543108	NECU-G78G4-C2
	Plug socket for mains connection 7/8", angled, 5-pin – open cable end, 5-core	2 m	573855	NEBU-G78W5-K-2-N-LE5
	Power supply socket M12x1, L-coded, straight	5-pin	8166793	NECL-L12G5-C2-Q10
	Power supply plug M12x1, L-coded, straight	5-pin	8166791	NECL-S-L12G5-C2-Q10
	Power supply socket M12x1, L-coded, angled	5-pin	8166794	NECL-L12W5-C2-Q10
	Power supply plug M12x1, L-coded, angled	5-pin	8166792	NECL-S-L12W5-C2-Q10
	Push-pull power supply socket, plug pattern PP, fulfils requirements to AIDA	5-pin	5195383	NECU-M-PPG5PP-C1-PN
	Straight plug, spring-loaded terminal, for left-hand end plate with system supply	7-pin	576319	NECU-L3G7-C1

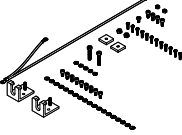
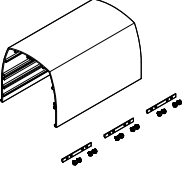
Datasheet

Ordering data – Accessories		Part no.	Type
Designation			
Inscription labels			
	Inscription labels 6x10 mm, 64 pieces, in a frame	18576	IBS-6x10
Hood			
	Mounting rail for attaching the hood	1000 mm	572256 CAFC-X1-S
	Mounting kit for CPX hood		572257 CAFC-X1-BE
	Hood section for CPX terminal including mounting attachments for connecting several hood sections in series.	200 mm	572258 CAFC-X1-GAL-200
		300 mm	572259 CAFC-X1-GAL-300
User documentation			
	CPX system manual	German	526445 CPX-SYS-DE
		English	526446 CPX-SYS-EN

Datasheet

User documentation – General information

Comprehensive user documentation is vital for the fast and reliable use of fieldbus components.

The manuals provided by Festo contain step-by-step instructions for using the CPX terminal:

1. Installation
2. Commissioning and parameterisation
3. Diagnostics

Application-oriented explanations are provided for integrating the CPX terminal in the programming and configuration software of the various controller manufacturers.

Use the order code to select the language you want.

The manuals for the configuration you have ordered are supplied automatically.

The documents can be downloaded quickly and easily from the Festo website.

→ www.festo.com



Overview – User documentation		
Type	Title	Description
Pneumatics		
P.BE-VTSA-44-...	Valve terminals with VTSA and VTSA-F pneumatics	Instructions on mounting, installation, commissioning and diagnostics of the VTSA and VTSA-F pneumatic components.
P.BE-MPA-...	Valve terminals with MPA-S pneumatics	Instructions on mounting, installation, commissioning and diagnostics of the MPA-S pneumatic components.
MPAL-VI-...	Valve terminal	Instructions on mounting, installation, commissioning and diagnostics of the MPA-L pneumatic components.

Datasheet

Overview – User documentation		
Type	Title	Description
Electronics		
CPX-SYS-...	System description, installation and commissioning	Overview of the design, components and mode of operation of the CPX terminal; installation and commissioning instructions as well as basic principles of parameterisation.
CPX-FVDA-P2-...	PROFIsafe shut-off module	Connection technology and mounting, installation and commissioning instructions for the PROFIsafe shut-off module of the type CPX-FVDA-P2.
CPX-AA/-_AE-...	CPX I/O modules, digital	Connection technology and mounting, installation and commissioning instructions for digital input and output modules of type CPX-... as well as the VTSA/VTSA-F and MPA-S/L pneumatic interface.
CPX-F8DE-P-...	Input module CPX-F8DE-N	Connection technology and mounting, installation and commissioning instructions for the PROFIsafe input module of type CPX-F8DE-P.
CPX-2ZE2DA-...	I/O module CPX-2ZE2DA	Connection technology and mounting, installation and commissioning instructions for counter modules of type CPX-2ZE2DA.
CPX-AA/-_AE-...	CPX-EA modules, analogue	Connection technology and mounting, installation and commissioning instructions for analogue input and output modules of type CPX-... as well as pressure sensors and proportional pressure regulators.
CPX-CP-4-FB-...	CPX CP interface	Instructions on mounting, installation, commissioning and diagnostics of the CP interface.
CPX-CTEL-4-M12-5POL-...	CPX CTEL interface	Instructions on mounting, installation, commissioning and diagnostics of the CPX CTEL master.
CPX-CTEL-2-M12-5POLLK-...	Electrical interface CPX-CTEL-2	Instructions on mounting, installation, commissioning and diagnostics for the CPX electrical interface for IO-Link®.
CPX-CM-HPP-...	CPX axis interface	Instructions on mounting, installation, commissioning and diagnostics of the CPX axis interface (CM-HPP).
CPX-CMAX-C1-1-...	CPX axis controller	Instructions on mounting, installation, commissioning and diagnostics of the CPX axis controller (CMAX).
CPX-CMAX-C1-1-...	CPX axis controller	Information on control, diagnostics and parameterisation of the axis controller via the fieldbus.
CPX-CMPX-C-1-H1-...	CPX end-position controller	Instructions on mounting, installation, commissioning and diagnostics of the CPX end-position controller (CMPX).
CPX-CMIX-M1-1-...	CPX measuring module	Instructions on mounting, installation, commissioning and diagnostics of the CPX measuring module (CMIX).
CPX-FB-...	CPX bus node	Instructions on mounting, installation, commissioning and diagnostics of the relevant bus node.
CPX-(M)-FB33_35/43_45-...	CPX bus node for PROFINET	Instructions on mounting, installation, commissioning and diagnostics of the relevant bus node.
P.BE-CPX-CEC-...	CPX-CODESYS controller (control block)	Instructions on mounting, installation, commissioning and diagnostics of the relevant control block.

User documentation – GSD, EDS, ...

Device description files and icons are used to explain the integration of the CPX terminal in the configuration software of the various controller manufacturers.

These can be downloaded quickly and easily from www.festo.com.

Datasheet – CPX maintenance tool

Function

The CPX Maintenance Tool (CPX-FMT) combines service software with a connecting adapter. The service software is a tool for the design, parameterisation and online diagnostics of the CPX terminal.

The USB-to-M12 adapter features built-in galvanic isolation (between CPX and PC) and enables a PC to be connected to the diagnostic interface of the CPX terminal.

- Adapter
- Software on CD-ROM



Application

Only from Festo

The CPX-FMT software enables access to CPX valve terminals via Ethernet with the bus nodes EtherNet/IP (FB 36), Sercos III (FB 39) and PROFINET (FB 33, FB 34, FB 35, FB 41, FB 45). The bus nodes or control blocks can be connected directly to a PC via a USB adapter from Festo. Diagnostic data such as the error trace or module diagnostics can be read out and parameters can be modified in plain text.

The data can be used directly on a PC. There is an option, for example, to send screenshots of a configuration or the current error trace directly via email. In addition, CPX configurations can also be saved and archived directly as a CPX-FMT project. Undocumented changes can subsequently be identified using the online/offline comparison function.

On-site tests such as the actuation of valves or the emulation of sensor feedback (in both cases called "forcing"), for example, can be carried out without an existing controller infrastructure.

It must be noted that with the CPX-FMT, only local parameters on the CPX valve terminal can be changed and saved. The configuration of the networks or controller software cannot be influenced.

General technical data		
Type		NEFC-M12G5-0.3-U1G5
System requirements	PC	IBM-compatible
	Drive	CD-ROM
	Interfaces	USB port (specification USB 1.1 or higher)
	Operating system	MS Windows 2000 or XP
Function range		<ul style="list-style-type: none"> • Configuration and parameterisation • Reading out of system, module, channel diagnostics and error trace • Saving the configuration as a project • Integration of plug-ins/links to self-executing programs
Scope of delivery		<ul style="list-style-type: none"> • Adapter, M12, 5-pin to mini USB socket • CD-ROM with installation program
Type of mounting		Screw-in
Electrical connection		Plug M12x1, 5-pin
Adapter cable composition		4 x 0.34 mm ²
Cable length	[m]	0.3
Degree of protection to EN 60529		IP20
CE marking (see declaration of conformity) ¹⁾		To EU RoHS Directive
UKCA marking (see declaration of conformity) ¹⁾		To UK RoHS regulations
Ambient temperature	[°C]	-5 ... +50
Material	Housing	ABS
	Cable sheath	PUR
	Pin contact	Gold-plated brass
Note on materials		RoHS-compliant
LABS (PWIS) conformity		VDMA24364-B2-L

1) More information www.festo.com/catalogue/... → Support/Downloads.

Datasheet – CPX maintenance tool

Dimensions

Download CAD data → www.festo.com

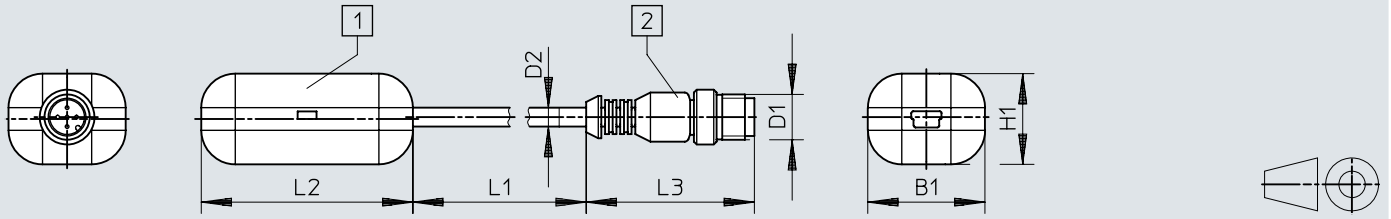

[1] USB connection Mini B 5P

[2] Plug M12x1, 5-pin

Type	B1	D1	D2	H1	L1	L2	L3
NEFC	31	M12x1	5	24	300	56	44.5

Ordering data

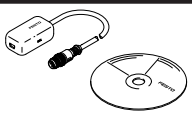
Designation	Part no.	Type
 CPX Maintenance Tool (CPX-FMT), software and USB-to-M12 adapter	547432	NEFC-M12G5-0.3-U1G5

Datasheet –Gateway CPX-IOT

- Industrial Ethernet
- TCP/IP
- OPC UA
- Web interface

Gateway for continuous transfer of operating data from connected Festo components to a central storage location (MQTT broker).

Comprehensive status information for the gateway is displayed using 7 specific LEDs.

The gateway can only be used as a combination with end plates and an interlinking block; no additional CPX modules are possible.

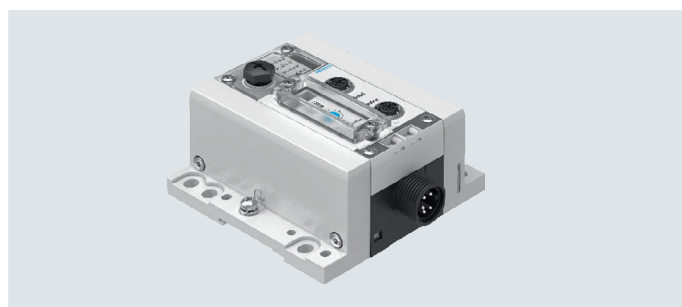

Application

Data collection

The CPX-IOT gateway gathers information and transfers it to a central storage location (customer's MQTT broker). The transfer takes place using secure protocols. The customer can only connect to the internet via a firewall. The extent of the data gathered and transferred is determined by the evaluation software (app).

Advantages:

- The central controller of the machine or system does not require an internet connection
- Operating data are available outside the system

Requirements:

- Connected components must have corresponding evaluation software (app)
- Internet connection
- Components to be monitored have an Industrial Ethernet interface
- MQTT broker

Information that can be evaluated (depending on the software):

- (Energy) consumption monitoring
- Preventive maintenance
- Visualisation of overall equipment effectiveness
- Identification data
- Diagnostic data
- Parameter data
- Operating status data

Interfaces

Onward communication between the gateway and the central storage location (MQTT broker) is via an Industrial Ethernet interface with M12x1 plug, D-coded to IEC947-5-2.

The operating mode of the gateway is set using a rotary switch. This enables simple interruption of this network connection on site.

Communication with the components being monitored is also via an Industrial Ethernet interface with M12x1 plug, D-coded to IEC 947-5-2.

Both connections have auto-negotiation and crossover detection as factory settings.

Datasheet – Gateway CPX-IOT

Configuration

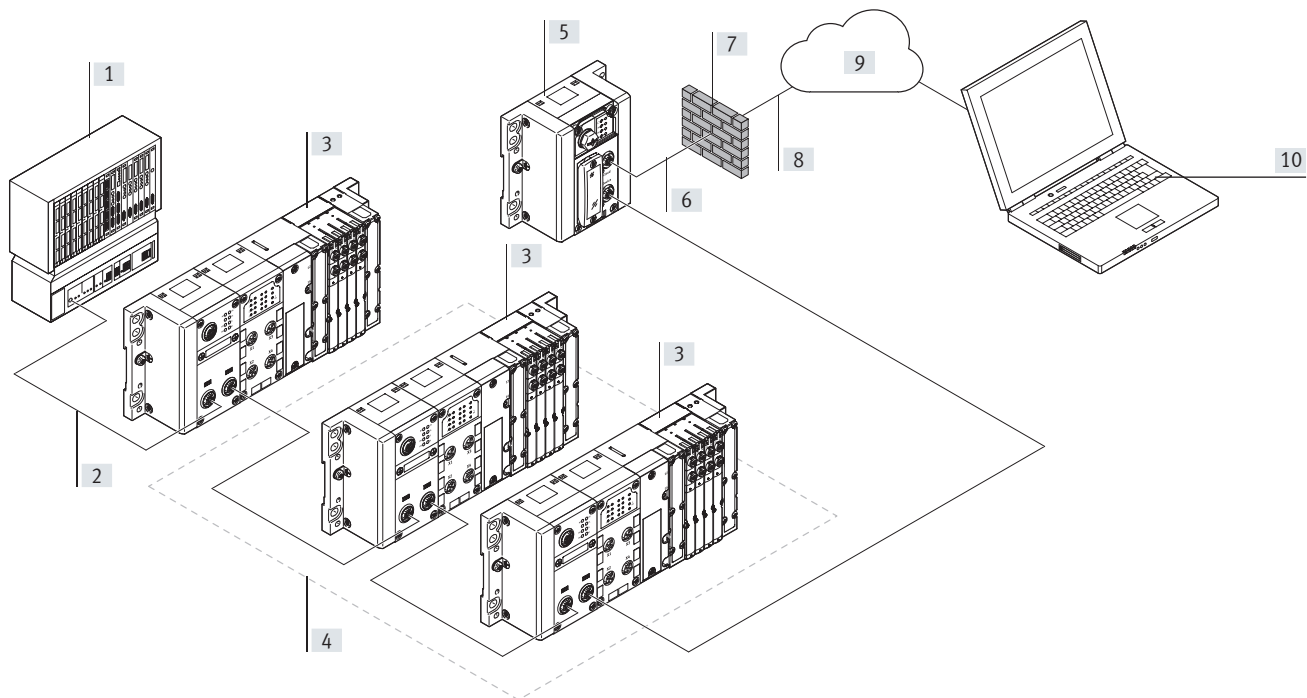

[1] PLC to machine/system controller (no direct internet connection)
 [2] Bus system from the controller to the system parts (e.g. PROFINET)

[3] Festo components with bus connection with serial links
 [4] Components from which the CPX-IOT is collecting and transferring data
 [5] Gateway CPX-IOT

[6] Internet connection
 [7] Customer firewall or other security precautions
 [8] Transferring data to a central storage location (MQTT broker) using secure protocols

[9] Central storage (customer's MQTT broker)
 [10] Simple decentralised evaluation of data using adapted programs (apps) for the components that are being monitored

Datasheet – Gateway CPX-IOT

General technical data			
Type		CPX-IOT	
Fieldbus interface	Protocol	Ethernet OPC UA	
	Function	Bus connection to Ethernet-based Festo devices	
	Connection type	Socket	
	Connection technology	M12x1, D-coded to EN 61076-2-101	
	Number of pins/cores	4	
	Galvanic isolation	Yes	
	Transmission rate [Mbps]	100	
Ethernet interface	Protocol	TCP/IP	
	Function	Connection to MQTT broker	
	Connection type	Socket	
	Connection technology	M12x1, D-coded to EN 61076-2-101	
	Number of pins/cores	4	
	Transmission rate [Mbps]	10 100	
CPU data		Dual core 533 MHz 256 MB RAM	
Configuration support		Integrated web server	
Diagnostics via LED		Modify Module location Network status Network status port 1 Network status port 2 Power supply, electronics/sensors Power supply load System errors Connection to the cloud	
	Control elements	Rotary switch for setting the operating mode DIL switch for resetting to delivery status	
	IP address setting		DHCP Static via web server

Technical data – Electrics

Nominal operating voltage DC for electronics/sensors	[V DC]	24
Permissible voltage fluctuations, electronics/sensors	[%]	±25
Power failure buffering	[ms]	10
Intrinsic current consumption at nominal operating voltage, electronics/sensors	[mA]	Typically 80
Protection against direct and indirect contact		PELV

Technical data – Mechanical components

Type of mounting		With DIN rail
Product weight	[g]	130
Grid dimension	[mm]	50
Dimensions W x L x H	[mm]	50 x 107 x 50

Materials

Housing		PA
Note on materials		RoHS-compliant
LABS (PWIS) conformity		VDMA24364-B2-L

Datasheet – Gateway CPX-IOT

Operating and environmental conditions		
Ambient temperature	[°C]	-5... +50
Storage temperature	[°C]	-20... +70
Relative humidity	[%]	95
		Non-condensing
Corrosion resistance class CRC1)		0
CE marking (see declaration of conformity) ³⁾		To EU EMC Directive ²⁾
Degree of protection		IP65
		IP67

- 1) More information www.festo.com/x/topic/crc
- 2) For information about the area of use, see the EC declaration of conformity at: [www.festo.com/catalogue/... d Support/Downloads](http://www.festo.com/catalogue/...d/Support/Downloads).
If the devices are subject to usage restrictions in residential, commercial or light-industrial environments, further measures for the reduction of the emitted interference may be necessary.
- 3) More information www.festo.com/catalogue/... → Support/Downloads.

Safety data	
Shock resistance	Shock test with severity level 1 to FN 942017-5 and EN 60068-2-27
Vibration resistant	Transport application test with severity level 1 to FN 942017-4 and EN 60068-2-6

Connection and display components

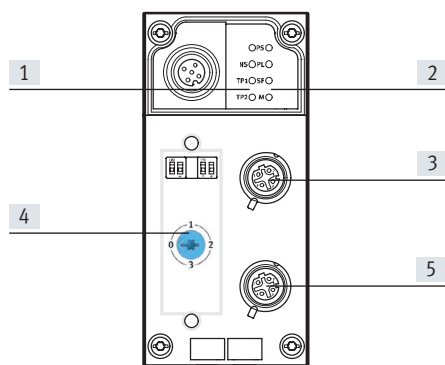

- [1] Network-specific LED displays
- [2] Gateway-specific LED displays
- [3] Connection to MQTT broker (socket M12x1, 4-pin, D-coded)
- [4] Transparent switch cover
- [5] Bus connection to Ethernet-based Festo devices (M12x1 socket, 4-pin, D-coded)





Pin assignment for MQTT broker connection and bus connection to Ethernet-based Festo devices			
Terminal assignment	Pin	Signal	Designation
Socket M12x1, D-coded			
	1	TD+	Transmitted data+
	2	RD+	Received data+
	3	TD-	Transmitted data-
	4	RD-	Received data-
	Housing	Shielding	Connected to functional earth (FE) via RC link

Datasheet – Gateway CPX-IOT

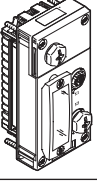
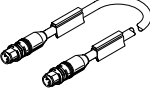

Combinations of interlinking blocks and gateway		
Interlinking blocks	Part no.	Gateway
		CPX-IOT
CPX-GE-EV-S	195746	■
CPX-GE-EV-S-VL	8022170	–
CPX-GE-EV-S-7/8-4POL	541248	–
CPX-GE-EV-S-7/8-5POL	541244	■
CPX-GE-EV-S-7/8-5POL-VL	8022172	–
CPX-M-GE-EV-S-7/8-CIP-4P	568956	–
CPX-M-GE-EV-S-7/8-5POL	550208	–
CPX-M-GE-EV-S-7/8-5POL-VL	8022165	–
CPX-M-GE-EV-S-PP-5POL	563057	–
CPX-GE-EV	195742	■
CPX-M-GE-EV	550206	–
CPX-M-GE-EV-FVO	567806	–
CPX-GE-EV-Z	195744	–
CPX-GE-EV-Z-7/8-4POL	541250	–
CPX-GE-EV-Z-7/8-5POL	541246	–
CPX-M-GE-EV-Z-7/8-5POL	550210	–
CPX-M-GE-EV-S-M12-5POL	8098392	–
CPX-M-GE-EV-Z-PP-5POL	563058	–
CPX-GE-EV-V	533577	–
CPX-M-GE-EV-W-M12-5POL	8098391	–

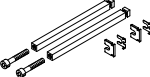
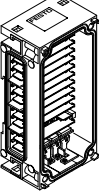
Combinations of end plates and gateway		
End plates	Part no.	Gateway
		CPX-IOT
CPX-EPL-EV	195716	■
CPX-EPL-EV-S	576315	■
CPX-EPL-EV-X	576314	–
CPX-EPR-EV	195714	■
CPX-EPR-EV-X	576313	–

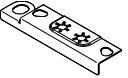
Datasheet – Gateway CPX-IOT

Ordering data				Part no.	Type
Gateway					
				8069773	CPX-IOT
Bus connection					
	Connecting cable, straight plug, M12x1, 4-pin, D-coded	Straight plug, M12x1, 4-pin, D-coded	0.5 m	8040446	NEBC-D12G4-ES-0.5-S-D12G4-ET
			1 m	8040447	NEBC-D12G4-ES-1-S-D12G4-ET
			3 m	8040448	NEBC-D12G4-ES-3-S-D12G4-ET
			5 m	8040449	NEBC-D12G4-ES-5-S-D12G4-ET
			10 m	8040450	NEBC-D12G4-ES-10-S-D12G4-ET
		Straight plug, RJ45, 8-pin	1 m	8040451	NEBC-D12G4-ES-1-S-R3G4-ET
			3 m	8040452	NEBC-D12G4-ES-3-S-R3G4-ET
			5 m	8040453	NEBC-D12G4-ES-5-S-R3G4-ET
Open end, 4-core	10 m	8040454	NEBC-D12G4-ES-10-S-R3G4-ET		
5 m	8040456	NEBC-LE4-ES-5-D12G4-ET			
	Cover cap for sealing unused bus connections (10 pieces)			165592	ISK-M12
Tie rods					
	Tie rod CPX	Tie rod CPX	1 valve	195718	CPX-ZA-1
Interlinking block					
	Without power supply		–	195742	CPX-GE-EV
	With system supply		M18	195746	CPX-GE-EV-S
			7/8" – 5-pin	541244	CPX-GE-EV-S-7/8-5POL
End plates					
	End plate, left	Without supply		195716	CPX-EPL-EV
		With system supply		576315	CPX-EPL-EV-S
	End plate, right		–	195714	CPX-EPR-EV
	Earthing component for right/left end plate		Pack of 5	538892	CPX-EPFE-EV

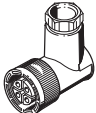
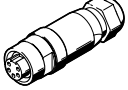
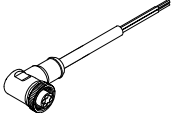
Datasheet – Gateway CPX-IOT

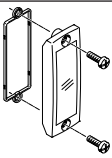
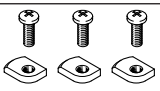
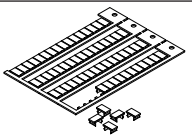
Ordering data				Part no.	Type
Designation					
Power supply					
	Plug socket for mains connection M18x1, 4-pin	Straight	For 1.5 mm ²	18493	NTSD-GD-9
			For 2.5 mm ²	18526	NTSD-GD-13,5
		Angled	For 1.5 mm ²	18527	NTSD-WD-9
			For 2.5 mm ²	533119	NTSD-WD-11
	Plug socket for mains connection 7/8", straight, 5-pin		0.25 ... 2.0 mm ²	543107	NECU-G78G5-C2
	Plug socket for mains connection 7/8", angled, 5-pin – open cable end, 5-core		2 m	573855	NEBU-G78W5-K-2-N-LE5
	Straight plug, spring-loaded terminal, for left-hand end plate with system supply		7-pin	576319	NECU-L3G7-C1
Covering					
	Inspection cover, transparent			533334	AK-SUB-9/15-B
Mounting					
	Mounting for DIN rail			526032	CPX-CPA-BG-NRH
Inscription labels					
	Inscription labels 6x10 mm, 64 pieces, in a frame			18576	IBS-6x10

Datasheet – CODESYS controller

- Industrial Ethernet
- TCP/IP
- EasyIP
- Web interface
- Email
- Data transfer

The CODESYS controller is a modern control system for CPX terminals that enables programming with CODESYS to IEC 61131-3.

The power supply to and communication with other modules takes place via the interlinking block.

In addition to network connections, LEDs are also provided for the bus status, operating status of the PLC and CPX peripherals information, as are switching elements and a diagnostic interface for CPX-FMT.



Application			
Bus connection		Communication protocols	Operating modes
The CPX-CEC is a remote controller that can be connected to a higher-order PLC via the bus nodes of the CPX terminal or via Ethernet.	At the same time, it is possible to operate the CPX-CEC as a compact stand-alone controller directly on the machine.	<ul style="list-style-type: none"> • Fieldbus via CPX bus node • Modbus/TCP • EasyIP 	<ul style="list-style-type: none"> • Stand-alone • Remote controller, fieldbus • Remote controller, Ethernet
Setting options			
The CPX-CEC has the following interfaces for monitoring, programming and commissioning:	<ul style="list-style-type: none"> • For the CPX-FMT • Ethernet interface for IT applications • Remote diagnostics 	The operating mode and fieldbus protocol are set using the DIL switch on the CPX-CEC.	The integrated web server offers a convenient means of querying data saved in the CPX-CEC.
Characteristics			
<ul style="list-style-type: none"> • Easy actuation of valve terminal configurations with MPA, VTSA • Diagnostics with flexible monitoring options for pressure, flow rate, cylinder operating time, air consumption 	<ul style="list-style-type: none"> • Activation of decentralised installation systems on the basis of CPI control of applications in proportional pneumatics • AS-Interface control via gateway 	<ul style="list-style-type: none"> • Connection to all fieldbuses as a remote controller and for pre-processing • Control of electric actuators as individual axes via CANopen (CPX-CEC-C1/-M1) 	<ul style="list-style-type: none"> • Early warnings and visualisation options • Servo-pneumatic applications

Datasheet – CODESYS controller

General technical data		
Protocol		CODESYS Level 2
		EasylP
		Modbus TCP
		TCP/IP
Processing time		Approx. 200 µs/1 k instructions
Programming software		CODESYS provided by Festo
Programming language		To IEC 61131-3
		Sequential function chart (SFC)
		Instruction list (IL)
		Function chart (FCH), additional continuous function chart (CFC)
		Ladder diagram (LD)
Programming	Operating language	German, English
	Support for file handling	Yes
Device-specific diagnostics		Diagnostics memory
		Channel and module-oriented diagnostics
		Undervoltage/short circuit of modules
LED indicators	Bus-specific	TP: Link/traffic
	Product-specific	RUN: PLC status
		STOP: PLC status
		ERR: PLC runtime error
		PS: Electronics supply, sensor supply
		PL: Load supply
		SF: System fault
M: Modify/forcing active		
IP address setting		DHCP
		Via CODESYS
		Via MMI
Function elements		CPX diagnostic status, copy CPX diagnostic trace, read CPX module diagnostics, and more
Dimensions (including interlinking block) W x L x H	[mm]	50 x 107 x 55

Materials	
Housing	Reinforced PA
	PC
Note on materials	RoHS-compliant
LABS (PWIS) conformity	VDMA24364-B2-L

Operating and environmental conditions		
Ambient temperature	[°C]	-5 ... +50
Storage temperature	[°C]	-20 ... +70
Relative humidity	[%]	95, non-condensing
Corrosion resistance class CRC1)		2

1) More information www.festo.com/x/topic/crc

Electrical data			
Nominal operating voltage	[V DC]		24
Load voltage	Nominal operating voltage	[V DC]	24
	With pneumatics type VTSA	[V DC]	21.6 ... 26.4
	With pneumatics type MPA	[V DC]	18 ... 30
	Without pneumatics	[V DC]	18 ... 30
Power failure buffering	[ms]		10
Intrinsic current consumption at nominal operating voltage	[mA]		Typically 85
Degree of protection to EN 60529			IP65, IP67

Datasheet – CODESYS controller

Technical data			CPX-CEC-C1	CPX-CEC-C1-V3	CPX-CEC-M1-V3
Type					
Additional functions			Motion functions for electric drives		SoftMotion functions for electric drives
CPU data	Flash	[MB]	32	32	32
	RAM	[MB]	32	256	256
	Processor	[MHz]	400	800	800
Control interface			CAN bus	CAN bus	CAN bus
Parameterisation			CODESYS V2.3	CODESYS V3	CODESYS V3
Configuration support			CODESYS V2.3	CODESYS V3	CODESYS V3
Program memory, user program			[MB]	4	16
Flags			Variable CODESYS concept		
	Remanent data	[kB]	30	28	28
	Global data memory	[MB]	8	–	–
Control elements			DIL switch for CAN termination		
			Rotary switch for RUN/STOP		
Total number of axes			31	127	31
Ethernet	No. of		1		
	Connection technology		RJ45 socket, 8-pin		
	Data transmission speed	[Mbps]	10/100		
	Supported protocols		TCP/IP, EasyIP, Modbus TCP		
Fieldbus interface	No. of		1		
	Connection technology		Sub-D plug, 9-pin		
	Data transmission speed, can be set via software	[kbps]	125, 250, 500, 800, 1000	125, 250, 500, 800, 1000	125, 250, 500, 800, 1000
	Supported protocols		CAN bus		
	Galvanic isolation		Yes		

Technical data			CPX-CEC	CPX-CEC-S1-V3
Type				
CPU data	Flash	[MB]	32	32
	RAM	[MB]	32	256
	Processor	[MHz]	400	800
Parameterisation			CODESYS V2.3	CODESYS V3
Configuration support			CODESYS V2.3	CODESYS V3
Additional functions			Diagnostic functions	
			RS232 communication function	
Program memory, user program			[MB]	4
Flags			Variable CODESYS concept	
	Remanent data	[kB]	30	28
	Global data memory	[MB]	8	–
Control elements			Rotary switch for RUN/STOP	
Ethernet	No. of		1	
	Connection technology		RJ45 socket, 8-pin	
	Data transmission speed	[Mbps]	10/100	
	Supported protocols		TCP/IP, EasyIP, Modbus TCP	
Data interface	No. of		1	
	Connection technology		Sub-D socket, 9-pin	
	Data transmission speed	[kbps]	9.6 ... 230.4	
	Supported protocols		RS232 interface	
	Max. cable length	[m]	–	30
	Galvanic isolation		Yes	

Datasheet – CODESYS controller

Connection and display elements CPX-CEC-C1/-M1

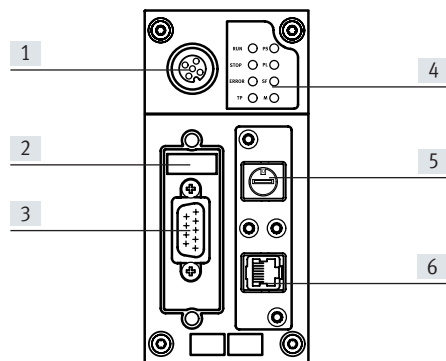

- [1] CPX-FMT connection
- [2] DIL switch
- [3] Fieldbus interface
(Sub-D plug, 9-pin)
- [4] Status LEDs, bus-specific and
product-specific
- [5] RUN/STOP rotary switch
- [6] Ethernet interface (RJ45 socket,
8-pin)

Pin assignment – CPX-CEC-C1/-M1

	Pin	Signal	Meaning
Fieldbus interface, Sub-D plug			
	1	n.c.	Not connected
	2	CAN_L	CAN low
	3	CAN_GND	CAN Ground
	4	n.c.	Not connected
	5	CAN_SHLD	Connection to functional earth FE
	6	CAN_GND	CAN Ground (optional) 1)
	7	CAN_H	CAN High
	8	n.c.	Not connected
	9	n.c.	Not connected
Housing	Shielding	Plug housing must be connected to FE	
Ethernet interface, RJ45 plug			
	1	TD+	Transmitted data+
	2	TD-	Transmitted data-
	3	RD+	Received data+
	4	n.c.	Not connected
	5	n.c.	Not connected
	6	RD-	Received data-
	7	n.c.	Not connected
	8	n.c.	Not connected
Housing	Shielding	Shielding	

1) If a servo drive is connected to an external power supply, CAN Ground (optional), pin 6, cannot be used on the CPX-CEC-C1/-M1.

Datasheet – CODESYS controller

Connection and display elements CPX-CEC/CPX-CEC-S1-V3

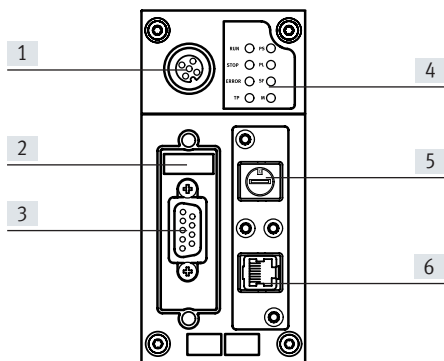







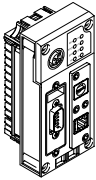

- [1] CPX-FMT connection
- [2] DIL switch
- [3] RS232 interface
(Sub-D socket, 9-pin)
- [4] Status LEDs, bus-specific and
product-specific
- [5] RUN/STOP rotary switch
- [6] Ethernet interface (RJ45 socket,
8-pin)

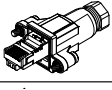

Pin assignment – CPX-CEC/CPX-CEC-S1-V3

	Pin	Signal	Meaning
RS 232 interface, Sub-D socket			
	1	n.c.	Not connected
	2	RxD	Received data
	3	TxD	Transmitted data
	4	n.c.	Not connected
	5	GND	Data reference potential
	6	n.c.	Not connected
	7	n.c.	Not connected
	8	n.c.	Not connected
	9	n.c.	Not connected
	Shielding	Shielding	Connection to functional earth
Ethernet interface, RJ45 plug			
	1	TD+	Transmitted data+
	2	TD-	Transmitted data-
	3	RD+	Received data+
	4	n.c.	Not connected
	5	n.c.	Not connected
	6	RD-	Received data-
	7	n.c.	Not connected
	8	n.c.	Not connected
	Housing	Shielding	Shielding

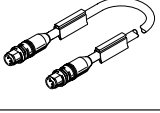
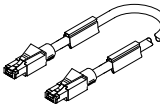
Datasheet – CODESYS controller

Ordering data						
Designation				Part no.	Type	
Control block						
	Motion functions for electric drives		CODESYS V2.3	155 g	567347	CPX-CEC-C1
			CODESYS V3	135 g	3473128	CPX-CEC-C1-V3
	SoftMotion functions for electric drives		CODESYS V3	135 g	3472765	CPX-CEC-M1-V3
	RS232 communication function		CODESYS V2.3	155 g	567346	CPX-CEC
			CODESYS V3	135 g	3472425	CPX-CEC-S1-V3
Fieldbus interface						
	Sub-D plug, 9-pin, for CANopen			532219	FBS-SUB-9-BU-2x5POL-B	
	Micro style bus connection, 2xM12 for DeviceNet/CANopen			525632	FBA-2-M12-5POL	
	Socket for micro style connection, M12			8162291	NECB-M12G5-C2	
	Plug for micro style connection, M12			8162296	NECB-S-M12G5-C2	
	Open style bus connection for 5-pin terminal strip for DeviceNet/CANopen			525634	FBA-1-SL-5POL	
	Terminal strip for open style connection, 5-pin			525635	FBSD-KL-2x5POL	
Ethernet interface						
	RJ45 plug		Degree of protection IP 65, IP67		534494	FBS-RJ45-8-GS
	Cover for RJ45 connection		Degree of protection IP 65, IP67		534496	AK-RJ45
	Straight plug, RJ45, 8-pin	Straight plug, M12x1, 4-pin, D-coded	Degree of protection IP20	1 m	8040451	NEBC-D12G4-ES-1-S-R3G4-ET
				3 m	8040452	NEBC-D12G4-ES-3-S-R3G4-ET
				5 m	8040453	NEBC-D12G4-ES-5-S-R3G4-ET
				10 m	8040454	NEBC-D12G4-ES-10-S-R3G4-ET
	Straight plug, RJ45, 8-pin	Straight plug, RJ45, 8-pin	Degree of protection IP20	1 m	8040455	NEBC-R3G4-ES-1-S-R3G4-ET

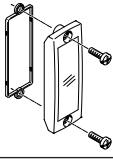
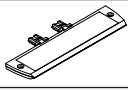
Datasheet – CODESYS controller

Ordering data		Part no.	Type
Designation			
Covers and attachments			
	Inspection cover, transparent, for Sub-D connection	533334	AK-SUB-9/15-B
	Inscription label holder for connection block	536593	CPX-ST-1
User documentation			
	Description control block CPX-CEC	German	569121 CPX-CEC-DE
		English	569122 CPX-CEC-EN

Datasheet – DeviceNet[®] bus node



Bus node for handling communication between the electrical terminal CPX and a DeviceNet[®] network.

The bus node is provided with system supply via the interlinking block and processes communication with the I/O modules.

The status of the CPX terminal is displayed as a common message via 4 CPX-specific LEDs.

The fieldbus communication status is displayed via the three DeviceNet[®]-specific LEDs.

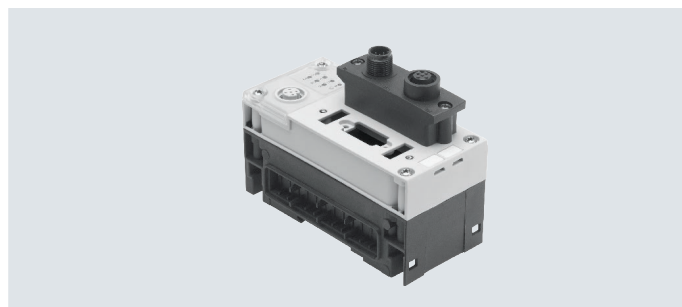

Application

Bus connection

The bus connection can be selected when ordering, either micro style as 2xM12 round plugs or open style as a terminal strip with IP20 protection.

Both connection types have the function of an integrated T-distributor with incoming and outgoing bus line.

DeviceNet[®] implementation

The CPX-FB11 operates with the Pre-defined Master/Slave Connection Set as a Group 2 Only Server.

The polled I/O, change of state or cyclic method is used for the transmission of cyclic I/O data. The type of transmission can be selected in the network configuration.

The device diagnostics for all bus nodes CPX-FB11 is effectively gathered via strobed I/O and displayed in the input table of the controller.

In addition to cyclic data transmission, acyclic communication is supported through explicit messaging, which enables detailed device diagnostics and parameterisation.

A comprehensive EDS file supports the display of acyclic data. It is also possible to display system information and assign parameters while the controller is running via the user program or the configuration software.

An example of this is access to the integrated diagnostic memory function, i.e. storage of the last 40 errors with timestamp, module, channel and error type.

With its address capacity of 64 byte inputs and 64 byte outputs, the CPX-FB11 supports any configuration of I/O modules, including pneumatic interface.

Points to note in connection with CPX-CEC

When a bus node is combined with a control block (CPX-CEC, in the fieldbus remote controller operating mode), the connected I/Os and/or valves, sensors and actuators are controlled via the CPX control block.

In this case, the bus node only provides the communication interface to the PLC.

Communication between the control block and CPX bus node takes place by linking the CPX modules and takes up

the following address capacity in the CPX system:

- 8 byte outputs
- 8 byte inputs

The following address capacity remains in the control block or CPX system for activating the peripherals:

- 56 byte inputs
- 56 byte outputs

Datasheet – DeviceNet® bus node

General technical data			
Type	CPX-FB11		
Fieldbus interface	Choice of <ul style="list-style-type: none"> • Micro style bus connection: 2xM12 with degree of protection IP65, IP67 • Open style bus connection: 5-pin terminal strip IP20 		
Baud rates	[kbps]	125, 250, 500	
Addressing range	0 ... 63 Set using DIL switch		
Product	Type	Communication adapter (12 dec.)	
	Code	4554 dec.	
Types of communication	Polled I/O, change of state/cyclic, strobed I/O and explicit messaging		
Configuration support	EDS file and bitmaps		
Max. address capacity	Inputs	[byte]	64
	Outputs	[byte]	64
LED displays (bus-specific)	MS = Module status NS = Network status IO = I/O status		
Device-specific diagnostics	Module and channel-oriented diagnostics via manufacturer-specific diagnostic object		
Parameterisation	<ul style="list-style-type: none"> • Module and system parameterisation via configuration interface in plain text (EDS) • Online in run or program mode 		
Additional functions	<ul style="list-style-type: none"> • Storage of the last 40 errors with timestamp (access via EDS) • 8-bit system status in image table for inputs • 2-byte inputs and 2-byte outputs, system diagnostics in process image 		
Control elements	DIL switches		
Operating voltage	Nominal width	[V DC]	24
	Permissible range	[V DC]	18 ... 30
	Power failure buffering	[ms]	10
Current consumption	[mA]	Typically 200	
Degree of protection to EN 60529	IP65, IP67		
Temperature range	Operation	[°C]	-5 ... +50
	Storage/transport	[°C]	-20 ... +70
Materials	Reinforced PA, PC		
LABS (PWIS) conformity	VDMA24364-B2-L		
Grid dimension	[mm]	50	
Dimensions (including interlinking block) W x L x H	[mm]	50 x 107 x 50	
Product weight	[g]	120	

 **Note**

Please observe the general limits and guidelines for the system when configuring the electrical modules.

Datasheet – DeviceNet® bus node

Connection and display components

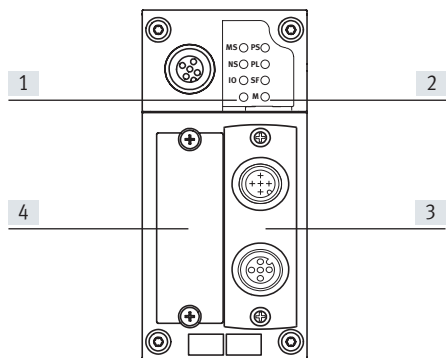



- [1] Bus-specific LEDs
- [2] CPX-specific status LEDs
- [3] Selectable fieldbus interface
 - Micro style
 - Open style
- [4] DIL switch cover

Pin assignment for the DeviceNet® interface

Terminal assignment	Pin	Signal-related wire colour ¹⁾	Signal	Designation
Sub-D plug				
	1	–	n.c.	Not connected
	2	Blue	CAN_L	Received/transmitted data low
	3	Black	0 V bus	0 V CAN interface
	4	–	n.c.	Not connected
	5	Clear	Shielding	Connection to housing
	6	–	n.c.	Not connected
	7	White	CAN_H	Received/transmitted data high
	8	–	n.c.	Not connected
	9	Red	24 V DC bus	24 V DC supply CAN interface
Micro style bus connection (M12), incoming/outgoing				
Incoming				
	1	Clear	Shielding	Connection to housing
	2	Red	24 V DC bus	24 V DC supply CAN interface
	3	Black	0 V bus	0 V CAN interface
	4	White	CAN_H	Received/transmitted data high
	5	Blue	CAN_L	Received/transmitted data low
Outgoing				
	1	Clear	Shielding	Connection to housing
	2	Red	24 V DC bus	24 V DC supply CAN interface
	3	Black	0 V bus	0 V CAN interface
	4	White	CAN_H	Received/transmitted data high
	5	Blue	CAN_L	Received/transmitted data low
Open style bus connection				
	1	Black	0 V bus	0 V CAN interface
	2	Blue	CAN_L	Received/transmitted data low
	3	Clear	Shielding	Connection to housing
	4	White	CAN_H	Received/transmitted data high
	5	Red	24 V DC bus	24 V DC supply CAN interface
7/8" bus connection				
	1	Black	Shielding	Connection to housing
	2	Blue	24 V DC	24 V DC supply CAN interface
	3	Clear	0 V	0 V CAN interface
	4	White	CAN_H	Received/transmitted data high
	5	Red	CAN_L	Received/transmitted data low

1) Typical of DeviceNet® connecting cables

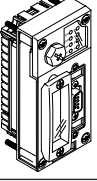
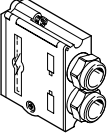
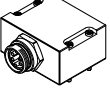
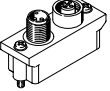
Datasheet – DeviceNet® bus node

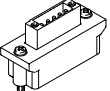
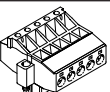
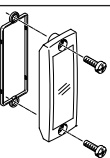
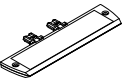
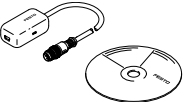
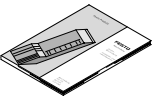
Ordering data		Part no.	Type
Designation			
Bus node			
	DeviceNet® bus node	526172	CPX-FB11
Bus connection			
	Sub-D plug	532219	FBS-SUB-9-BU-2x5POL-B
	Connection block, Sub-D socket 9-pin, plug 7/8" 5-pin	571052	CPX-AB-1-7/8-DN
	Micro style bus connection, 2xM12	525632	FBA-2-M12-5POL
	Socket for micro style connection, M12	8162291	NECB-M12G5-C2
	Plug for micro style connection, M12	8162296	NECB-S-M12G5-C2
	Open style bus connection for 5-pin terminal strip	525634	FBA-1-SL-5POL
	Terminal strip for open style connection, 5-pin	525635	FBSD-KL-2x5POL
	Inspection cover, transparent	533334	AK-SUB-9/15-B
	Inscription label holder for connection block	536593	CPX-ST-1
	Adapter M12, 5-pin to mini USB socket, and controller software	547432	NEFC-M12G5-0.3-U1G5
User documentation			
	User documentation for bus node CPX-FB11	German	526421 CPX-FB11-DE
		English	526422 CPX-FB11-EN
		Spanish	526423 P.BE-CPX-FB11-ES
		French	526424 P.BE-CPX-FB11-FR
		Italian	526425 P.BE-CPX-FB11-IT

Datasheet – PROFIBUS bus node



Bus node for handling communication between the electrical terminal CPX and a higher-order master via PROFIBUS DP.

The bus node is provided with system supply via the interlinking block and processes communication with the I/O modules.

The status of the CPX terminal is displayed as a common message via 4 CPX-specific LEDs.

The fieldbus communication status is displayed via the PROFIBUS-specific error LED.

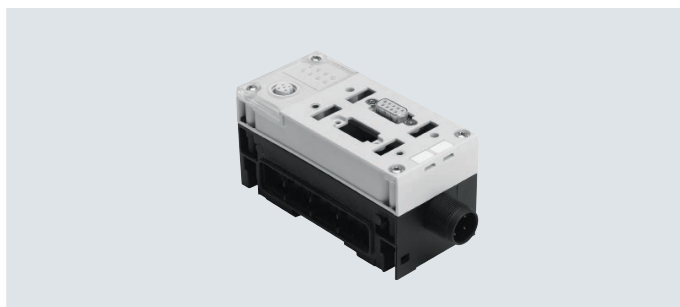

Application

Bus connection

The bus connection is established via a 9-pin Sub-D socket with a typical PROFIBUS allocation (to EN 50170).

The bus connector plug (with degree of protection IP65/IP67 from Festo or degree of protection IP20 from other manufacturers) facilitates the connection of an incoming and an outgoing bus cable.

An active bus terminal can be connected using the DIL switch integrated in the plug.

The Sub-D interface is designed for controlling network components with a fibre-optic cable connection.

PROFIBUS DP implementation

The CPX-FB13 supports the PROFIBUS DP protocol to EN 50170 Volume 2 for cyclic I/O exchange, parameterisation and diagnostic functions (DPV0).

In addition to DPV0, acyclic communication to the advanced specification DPV1 is supported. DPV1 provides acyclic access to advanced system information and allows parameterisation while the controller is running via the user program.

An example of this is access to the integrated diagnostic memory function, i.e. storage of the last 40 errors with timestamp, module, channel and error type.

With its address capacity of 64 byte inputs and 64 byte outputs, the CPX-FB13 supports any configuration of I/O modules, including pneumatic interface.

Points to note in connection with CPX-CEC

When a bus node is combined with a control block (CPX-CEC, in the fieldbus remote controller operating mode), the connected I/Os and/or valves, sensors and actuators are controlled via the CPX control block.

In this case, the bus node only provides the communication interface to the PLC.

Communication between the control block and CPX bus node takes place by linking the CPX modules and takes up the following address capacity in the CPX system:

- 8 byte outputs
- 8 byte inputs

The following address capacity remains in the control block or CPX system for activating the peripherals:

- 56 byte inputs
- 56 byte outputs

Datasheet – PROFIBUS bus node

General technical data			
Type	CPX-FB13		
Fieldbus interface	Sub-D socket, 9-pin (EN 50170) Galvanically isolated 5 V		
Baud rates	[Mbps]	0.0096 ... 12	
Addressing range	1 ... 125 Set using DIL switch		
Product family	4: Valves		
ID number	0x059E		
Types of communication	DPV0: Cyclic communication DPV1: Acyclic communication		
Configuration support	GSD file and bitmaps		
Max. address capacity	Inputs	[byte]	64
	Outputs	[byte]	64
LED displays (bus-specific)	BF: Bus fault		
Device-specific diagnostics	Identifier and channel-oriented diagnostics to EN 50170 (PROFIBUS standard)		
Parameterisation	<ul style="list-style-type: none"> Start-up parameterisation via configuration interface in plain text (GSD) Acyclical parameterisation via DPV1 		
Additional functions	<ul style="list-style-type: none"> Storage of the last 40 errors with timestamp (access via DPV1) 8-bit system status in image table for inputs 2-byte inputs and 2-byte outputs, system diagnostics in process image 		
Control elements	DIL switches		
Operating voltage	Nominal width	[V DC]	24
	Permissible range	[V DC]	18 ... 30
	Power failure buffering	[ms]	10
Current consumption			[mA] Typically 200
Degree of protection to EN 60529	IP65, IP67		
Temperature range	Operation	[°C]	-5 ... +50
	Storage/transport	[°C]	-20 ... +70
Materials	Reinforced PA, PC		
LABS (PWIS) conformity	VDMA24364-B2-L		
Grid dimension			[mm] 50
Dimensions (including interlinking block) W x L x H			[mm] 50 x 107 x 50
Product weight			[g] 115

 **Note**

Please observe the general limits and guidelines for the system when configuring the electrical modules.

Datasheet – PROFIBUS bus node

Connection and display components

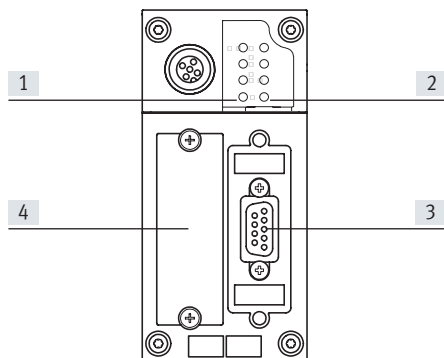



- [1] Bus status LEDs/bus fault
- [2] CPX-specific status LEDs
- [3] Fieldbus interface (Sub-D socket, 9-pin)
- [4] DIL switch cover

Pin assignment for PROFIBUS DP interface

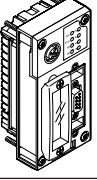
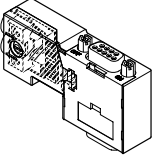
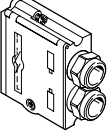
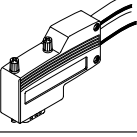
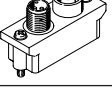
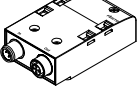
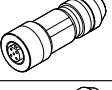
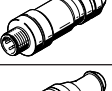

Terminal assignment	Pin	Signal	Designation
Sub-D socket			
	1	n.c.	Not connected
	2	n.c.	Not connected
	3	RxD/TxD-P	Received/transmitted data P
	4	CNTR-P ¹⁾	Repeater control signal
	5	DGND	Data reference potential (M5V)
	6	VP	Supply voltage (P5V)
	7	n.c.	Not connected
	8	RxD/TxD-N	Received/transmitted data N
	9	n.c.	Not connected
Housing	Shielding	Connection to housing	
Bus connection M12 adapter (B-coded)			
Incoming			
	1	n.c.	Not connected
	2	RxD/TxD-N	Received/transmitted data N
	3	n.c.	Not connected
	4	RxD/TxD-P	Received/transmitted data P
	5 and M12	Shielding	Connection to FE (functional earth)
Outgoing			
	1	VP	Supply voltage (P5V)
	2	RxD/TxD-N	Received/transmitted data N
	3	DGND	Data reference potential (M5V)
	4	RxD/TxD-P	Received/transmitted data P
	5 and M12	Shielding	Connection to FE (functional earth)

1) The repeater control signal CNTR-P is realised as a TTL signal.

Datasheet – PROFIBUS bus node

Ordering data		Part no.	Type
Designation			
Bus node			
	PROFIBUS bus node	195740	CPX-FB13
Bus connection			
	Sub-D plug, straight, with terminating resistor and programming interface	574589	NECU-S1W9-C2-APB
	Sub-D plug, straight	532216	FBS-SUB-9-GS-DP-B
	Sub-D plug, angled	533780	FBS-SUB-9-WS-PB-K
	Bus connection M12 adapter (B-coded)	533118	FBA-2-M12-5POL-RK
	Connection block M12 adapter (B-coded)	541519	CPX-AB-2-M12-RK-DP
	5-pin M12x1 straight socket, for self-assembly of a connecting cable compatible with FBA-2-M12-5POL-RK and CPX-AB-2-M12-RK-DP	1067905	NECU-M-B12G5-C2-PB
	Plug M12x1, 5-pin, straight, for self-assembly of a connecting cable compatible with FBA-2-M12-5POL-RK and CPX-AB-2-M12-RK-DP	1066354	NECU-M-S-B12G5-C2-PB
	Terminating resistor, M12, B-coded for PROFIBUS	1072128	CACR-S-B12G5-220-PB

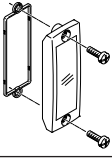
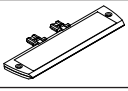
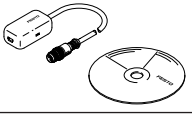
Datasheet – PROFIBUS bus node

Ordering data		Part no.	Type
Designation			
Bus connection			
	Inspection cover, transparent	533334	AK-SUB-9/15-B
	Inscription label holder for connection block M12	536593	CPX-ST-1
	Adapter M12, 5-pin to mini USB socket, and controller software	547432	NEFC-M12G5-0.3-U1G5
User documentation			
	User documentation for bus node CPX-FB13	German	526427 CPX-FB13-DE
		English	526428 CPX-FB13-EN

Datasheet – CC-Link® bus node



Bus node for handling communication between the electrical terminal CPX and a higher-order master for Control & Communication-Link (CC-Link®) from Mitsubishi.

The bus node is provided with system supply via the interlinking block and processes communication with the I/O modules.

The status of the CPX terminal is displayed as a common message via 4 CPX-specific LEDs.

The status of the fieldbus communication is displayed via 4 CC-Link®-specific LEDs.



Application

Bus connection

The bus connection can be selected when ordering and is established via a screw terminal with degree of protection IP20, a Sub-D plug with degree of

protection IP65/IP67 from Festo or degree of protection IP20 from other manufacturers.

Both connection types have the function of an integrated T-distributor and thus support the connection of an incoming and outgoing bus cable.

CC-Link® implementation

The CPX bus node CPX-FB23-24 optionally supports the CC-Link® versions 2.0 (as function module F24) and 1.1 (as function module F23). These designations are also found in the system diagram for the CPX Maintenance Tool (CPX-FMT) from Festo.

Function module F24 corresponds to CC-Link® version 2.0 and supports a maximum of four stations per slave, up to an address capacity of 64 bytes of digital I/O and 64 bytes of analogue I/O in each case. It is possible to optimise the configuration of the addressing in terms of either cycle time or station.

Function module F23 corresponds to CC-Link® version 1.1 and supports a maximum of four stations per slave, up to an address capacity of 32 bytes of digital I/O and 14 bytes of analogue I/O in each case.

The function module and option are set using the DIL switch on the CPX bus node.

Points to note in connection with CPX-CEC

When a bus node is combined with a control block (CPX-CEC, in the fieldbus remote controller operating mode), the connected I/Os and/or valves, sensors and actuators are controlled via the CPX control block.

In this case, the bus node only provides the communication interface to the PLC. Communication between the control block and CPX bus node takes place by linking the CPX modules and takes up

the following address capacity in the CPX system:

- 8 byte outputs
- 8 byte inputs

The following address capacity remains in the control block or CPX system for activating the peripherals:

- 56 byte inputs
- 56 byte outputs

Datasheet – CC-Link[®] bus node

General technical data				
Type	CPX-FB23-24			
Fieldbus interface	Choice of <ul style="list-style-type: none"> • Sub-D socket, 9-pin • Sub-D plug, for self-assembly • Screw terminal strip, IP20 			
Baud rates	[kbps]	156 ... 10000		
Protocol	CC-LINK [®]			
Max. address capacity, inputs	FB23	RWr	[byte]	32
		Rx	[byte]	14
	FB24	RWr	[byte]	64
		Rx	[byte]	64
Max. address capacity, outputs	FB23	RWw	[byte]	32
		Ry	[byte]	14
	FB24	RWw	[byte]	64
		Ry	[byte]	64
LED displays (bus-specific)	RUN = Communication status ERROR = Communication error SD = Send data RD = Receive data			
Device-specific diagnostics	<ul style="list-style-type: none"> • Diagnostics memory • Channel and module-oriented diagnostics • Undervoltage of modules 			
Parameterisation	<ul style="list-style-type: none"> • Diagnostic behaviour • Fail-safe response • Forcing of channels • Signal setup • System parameters 			
Additional functions	<ul style="list-style-type: none"> • System status can be displayed using process data • Additional diagnostic interface for operator units 			
Control elements	DIL switches			
Operating voltage	Nominal width	[V DC]	24	
	Permissible range	[V DC]	18 ... 30	
Current consumption		[mA]	Typically 200	
Degree of protection to EN 60529	IP65, IP67			
Temperature range	Operation	[°C]	–5 ... +50	
	Storage/transport	[°C]	–20 ... +70	
Materials	Reinforced PA, PC			
LABS (PWIS) conformity	VDMA24364-B2-L			
Grid dimension		[mm]	50	
Dimensions (including interlinking block) W x L x H		[mm]	50 x 107 x 50	
Product weight		[g]	115	

 **Note**

Please observe the general limits and guidelines for the system when configuring the electric modules.

Datasheet – CC-Link® bus node

Connection and display components

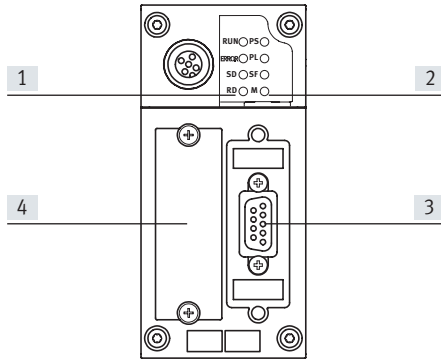





- [1] Bus-specific status LEDs
- [2] CPX-specific status LEDs
- [3] Fieldbus interface (Sub-D socket, 9-pin)
- [4] DIL switch cover

Pin assignment for the CC-Link® interface

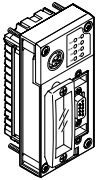
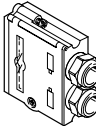
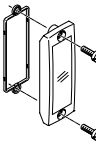
Terminal assignment	Pin	Signal	Designation
Sub-D socket			
	1	n.c.	Not connected
	2	DA	Data A
	3	DG	Data reference potential
	4	n.c.	Not connected
	5	FE ¹⁾	Functional earth
	6	n.c.	Not connected
	7	DB	Data B
	8	n.c.	Not connected
	9	n.c.	Not connected
Bus connection – screw terminal			
	1	FG	Functional earth/housing
	2	SLD	Shielding
	3	DG	Data reference potential
	4	DB	Data B
	5	DA	Data A

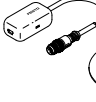
Datasheet – CC-Link® bus node

Ordering data		Part no.	Type
Designation			
Bus node			
	CC-Link® bus node	526176	CPX-FB23-24
Bus connection			
	Sub-D plug	532220	FBS-SUB-9-GS-2x4POL-B
	Inspection cover, transparent	533334	AK-SUB-9/15-B
	Inscription label holder for connection block	536593	CPX-ST-1
	Adapter M12, 5-pin to mini USB socket, and controller software	547432	NEFC-M12G5-0.3-U1G5
User documentation			
	User documentation for bus node CPX-FB23-24	German	526403 CPX-FB23-24-DE
		English	526404 CPX-FB23-24-EN
		Chinese	8026069 P.BE-CPX-FB23-24-ZH

Datasheet – PROFINET bus node, M12, D-coded



Bus node for operating the CPX valve terminal on PROFINET.

The bus node is provided with system supply via the interlinking block and processes communication with the I/O modules.

The status of the CPX terminal is displayed as a common message via 4 CPX-specific LEDs.

The fieldbus communication status is displayed via three bus-specific LEDs.

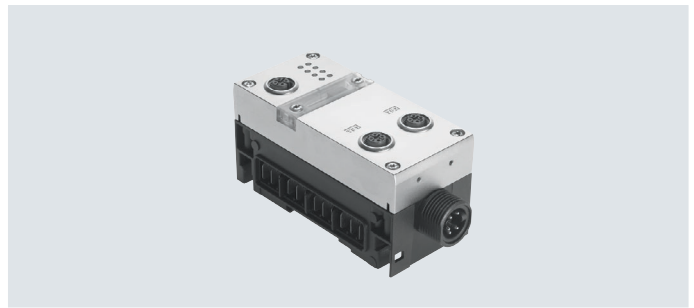
**Application**

Bus connection

The bus connection is established via two sockets M12, D-coded to IEC 61076-2-101 with degree of protection IP65, IP67.

Both connections are equivalent 100BaseTX Ethernet ports with integrated auto MDI functionality (cross-over and patch cables can be used) that are brought together via an internal switch.

- Maximum segment length 100 m
- Transmission rate 100 Mbps

PROFINET implementation

The bus nodes support the PROFINET protocol on the basis of the Ethernet standard and TCP/IP technology to IEEE802.3.

This guarantees a data exchange with a high data transmission rate, for example I/O data from sensors, actuators or robot controllers, PLCs or process equipment. In addition, non-real-time critical information such as diagnostic

information, configuration information, etc. can be transferred. The Ethernet bandwidth is sufficient to transfer both data types (real-time and non-real-time) in parallel.

The bus node features LEDs for bus status and CPX peripheral information as well as switch elements and a diagnostic interface. PROFINET provides the

user with access to all peripherals, diagnostic data and parameter data of the CPX valve terminal. The bus node can be used as a remote I/O or remote controller. All information relevant to the CPX can be read out and, dependent on the function, changed via CPX-FMT.

Points to note in connection with CPX-CEC

When a bus node is combined with a control block (CPX-CEC, in the fieldbus remote controller operating mode), the connected I/Os and/or valves, sensors and actuators are controlled via the CPX control block.

In this case, the bus node only provides the communication interface to the PLC. Communication between the control block and CPX bus node takes place by linking the CPX modules and takes up

the following address capacity in the CPX system:

- 8 byte outputs
- 8 byte inputs

The following address capacity remains in the control block or CPX system for activating the peripherals:

- 56 byte inputs
- 56 byte outputs

Datasheet – PROFINET bus node, M12, D-coded

General technical data		
Type		CPX-FB43
Fieldbus interface		2x socket, M12, 4-pin, D-coded
Baud rates	[Mbps]	100
Protocol		PROFINET RT PROFINET IRT
Max. address capacity	Inputs	[byte] 64
	Outputs	[byte] 64
LED indicators	(bus-specific)	M/P = Maintenance/PROFenergy NF = Network error TP1 = Network active, port 1 TP2 = Network active, port 2
	(product-specific)	M = Modify, parameterisation PL = Load supply PS = Electronic supply, sensor supply SF = System error
Device-specific diagnostics		<ul style="list-style-type: none"> Channel and module-oriented diagnostics Undervoltage of modules Diagnostics memory
Configuration support		GSDML file
Parameterisation		<ul style="list-style-type: none"> System parameters Diagnostic behaviour Signal setup Fail-safe response Forcing of channels
Additional functions		<ul style="list-style-type: none"> Start-up parameterisation in plain text via fieldbus Fast start-up (FSU) Channel-oriented diagnostics via fieldbus Acyclic data access via fieldbus and via Ethernet System status can be displayed using process data Additional diagnostic interface for operator unit
		<ul style="list-style-type: none"> I&M LLDP MRP MRPD MQTT PROFIsafe PROFenergy S2 system redundancy
Control elements		<ul style="list-style-type: none"> DIL switches
Operating voltage	Nominal width	[V DC] 24
	Permissible range	[V DC] 18 ... 30
Current consumption		[mA] Typically 70
Degree of protection to EN 60529		IP65, IP67
Temperature range	Operation	[°C] -5... +50
	Storage/transport	[°C] -20 ... +70
Certification		RCM
Materials	Housing	Die-cast aluminium
Note on materials		RoHS-compliant
LABS (PWIS) conformity		VDMA24364-B2-L
Dimensions (including interlinking block) W x L x H		[mm] 50 x 107 x 50
Product weight		[g] 185

**Note**

Please observe the general limits and guidelines for the system when configuring the electric modules.

**Note**

Always use the correct screws for the interlinking block; this depends on whether the block is made of metal or polymer:

- Self-tapping screws for polymer interlinking blocks
- Screws with metric thread for metal interlinking blocks

Datasheet – PROFINET bus node, M12, D-coded

Connection and display components

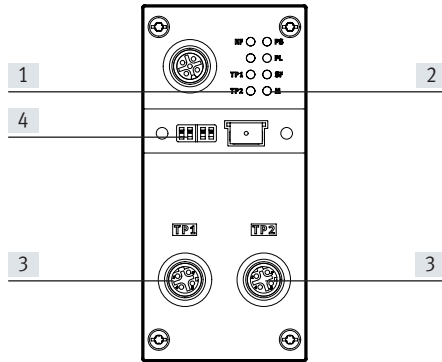



- [1] Bus-specific status LEDs
- [2] CPX-specific status LEDs
- [3] Fieldbus interface (socket M12, 4-pin, D-coded)
- [4] Transparent DIL switch cover

Pin assignment for the fieldbus interface

Terminal assignment	Pin	Signal	Designation
Socket, M12, D-coded			
	1	TD+	Transmitted data+
	2	RD+	Received data+
	3	TD-	Transmitted data-
	4	RD-	Received data-
	Housing		Shielding

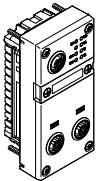
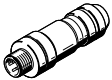
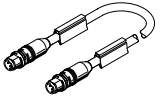
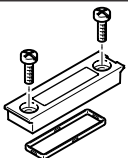
Datasheet – PROFINET bus node, M12, D-coded

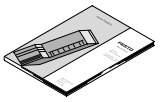
Ordering data				Part no.	Type
Designation					
Bus node					
	PROFINET bus node	<ul style="list-style-type: none"> • I&M • LLDP • MRP • MRPD • PROFINergy • S2 system redundancy 		8110369	CPX-FB43
Bus connection					
	Plug M12x1, 4-pin, D-coded			543109	NECU-M-S-D12G4-C2-ET
	Connecting cable, straight plug, M12x1, 4-pin, D-coded	Straight plug, M12x1, 4-pin, D-coded	0.5 m	8040446	NEBC-D12G4-ES-0.5-S-D12G4-ET
			1 m	8040447	NEBC-D12G4-ES-1-S-D12G4-ET
			3 m	8040448	NEBC-D12G4-ES-3-S-D12G4-ET
			5 m	8040449	NEBC-D12G4-ES-5-S-D12G4-ET
			10 m	8040450	NEBC-D12G4-ES-10-S-D12G4-ET
		Straight plug, RJ45, 8-pin	1 m	8040451	NEBC-D12G4-ES-1-S-R3G4-ET
			3 m	8040452	NEBC-D12G4-ES-3-S-R3G4-ET
			5 m	8040453	NEBC-D12G4-ES-5-S-R3G4-ET
			10 m	8040454	NEBC-D12G4-ES-10-S-R3G4-ET
Open end, 4-core	5 m	8040456	NEBC-LE4-ES-5-D12G4-ET		
	Transparent cover for the DIL switches			548757	CPX-AK-P
	Cover cap for sealing unused bus connections (10 pieces)			165592	ISK-M12
User documentation					
	Description electronics, CPX bus node	German	548759	CPX-(M)-FB33_35/43_45-DE	
		English	548760	CPX-(M)-FB33_35/43_45-EN	
		Spanish	548761	CPX-(M)-FB33_35/43_45-ES	
		French	548762	CPX-(M)-FB33_35/43_45-FR	
		Italian	548763	CPX-(M)-FB33_35/43_45-IT	

Datasheet – PROFINET bus node, push-pull RJ45



Bus node for operating the CPX valve terminal on PROFINET.

The bus node is provided with system supply via the interlinking block and processes communication with the I/O modules.

The status of the CPX terminal is displayed as a common message via 4 CPX-specific LEDs.

The status of the fieldbus communication is displayed via 4 bus-specific LEDs.

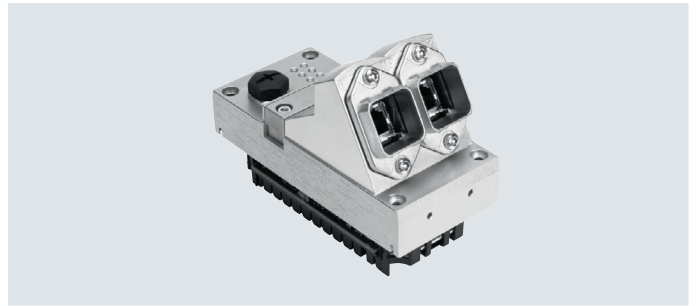

Application

Bus connection

The bus connection is established via two RJ45 push-pull sockets to IEC 61076-3-106 and IEC 60603 with degree of protection IP65, IP67.

Both connections are equivalent 100BaseTX Ethernet ports with integrated auto MDI functionality (cross-over and patch cables can be used) that are brought together via an internal switch.

- Maximum segment length 100 m
- Transmission rate 100 Mbps

PROFINET implementation

The bus nodes support the PROFINET protocol on the basis of the Ethernet standard and TCP/IP technology to IEEE802.3.

This guarantees a data exchange with a high data transmission rate, for example I/O data from sensors, actuators or robot controllers, PLCs or process equipment. In addition, non-real-time critical information such as diagnostic

information, configuration information, etc. can be transferred.

The Ethernet bandwidth is sufficient to transfer both data types (real-time and non-real-time) in parallel.

The bus nodes feature LEDs for bus status and CPX peripheral information as well as switch elements and a diagnostic interface. PROFINET provides the

user with access to all peripherals, diagnostic data and parameter data of the CPX valve terminal. The bus node can be used as a remote I/O or remote controller. All information relevant to the CPX can be read out and, dependent on the function, changed via CPX-FMT.

Points to note in connection with CPX-CEC

When a bus node is combined with a control block (CPX-CEC, in the fieldbus remote controller operating mode), the connected I/Os and/or valves, sensors and actuators are controlled via the CPX control block.

In this case, the bus node only provides the communication interface to the PLC.

Communication between the control block and CPX bus node takes place by linking the CPX modules and takes up

the following address capacity in the CPX system:

- 8/16 byte outputs
- 8/16 byte inputs

The following address capacity remains in the control block or CPX system for activating the peripherals:

- 56/48 byte inputs
- 56/48 byte outputs

Datasheet – PROFINET bus node, push-pull RJ45

General technical data		
Type	CPX-M-FB44	
Fieldbus interface	2x RJ45 push-pull socket, AIDA	
Baud rate	[Mbps]	100
Protocol	PROFINET RT PROFINET IRT	
Max. address capacity	Inputs	[byte] 64
	Outputs	[byte] 64
LED indicators	(bus-specific)	M/P = Maintenance/PROFenergy NF = Network error TP1 = Network active, port 1 TP2 = Network active, port 2
	(product-specific)	M = Modify, parameterisation PL = Load supply PS = Electronic supply, sensor supply SF = System error
Device-specific diagnostics	<ul style="list-style-type: none"> • Channel and module-oriented diagnostics • Undervoltage of modules • Diagnostics memory 	
Configuration support	GSDML file	
Parameterisation	<ul style="list-style-type: none"> • System parameters • Diagnostic behaviour • Signal setup • Fail-safe response • Forcing of channels 	
Additional functions	<ul style="list-style-type: none"> • Start-up parameterisation in plain text via fieldbus • Fast start-up (FSU) • Channel-oriented diagnostics via fieldbus • Acyclic data access via fieldbus and via Ethernet • System status can be displayed using process data • Additional diagnostic interface for operator unit 	
	<ul style="list-style-type: none"> • I&M • LLDP • MRP • MRPD • MQTT • PROFI-safe • PROFenergy • S2 system redundancy 	
Control elements	<ul style="list-style-type: none"> • DIL switches 	
Operating voltage	Nominal width	[V DC] 24
	Permissible range	[V DC] 18 ... 30
Intrinsic current consumption at nominal operating voltage	[mA]	Typ. 70
Degree of protection to EN 60529	IP65, IP67	
Temperature range	Operation	[°C] -5... +50
	Storage/transport	[°C] -20 ... +70
Certification	RCM	
Material information: Housing	Die-cast aluminium	
Note on materials	RoHS-compliant	
LABS (PWIS) conformity	VDMA24364-B2-L	
Dimensions (including interlinking block) W x L x H	[mm]	50 x 107 x 80
Product weight	[g]	280

**Note**

Please observe the general limits and guidelines for the system when configuring the electric modules.

**Note**

Always use the correct screws for the interlinking block; this depends on whether the block is made of metal or polymer:

- Self-tapping screws for polymer interlinking blocks
- Screws with metric thread for metal interlinking blocks

Datasheet – PROFINET bus node, push-pull RJ45

Connection and display components

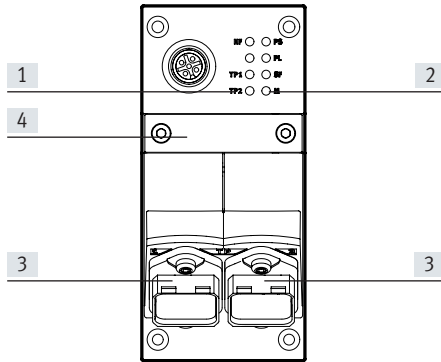





- [1] Bus-specific status LEDs
- [2] CPX-specific status LEDs
- [3] Fieldbus interface (RJ45 socket, 8-pin)
- [4] DIL switch

Pin assignment for the fieldbus interface

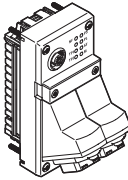
Terminal assignment	Pin	Signal	Designation
RJ45 socket			
	1	TD+	Transmitted data+
	2	TD-	Transmitted data-
	3	RD+	Received data+
	4	n.c.	Not connected
	5	n.c.	Not connected
	6	RD-	Received data-
	7	n.c.	Not connected
	8	n.c.	Not connected
	Housing	Shielding	Shielding

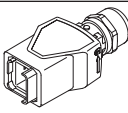
Datasheet – PROFINET bus node, push-pull RJ45

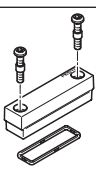
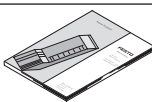
Ordering data		Part no.	Type															
Designation																		
Bus node																		
	PROFINET bus node	<ul style="list-style-type: none"> • I&M • LLDP • MRP • MRPD • PROFlenergy • S2 system redundancy 	8110370 CPX-M-FB44															
Bus connection																		
	Plug RJ45, 8-pin	Push-pull with locking mechanism against unintentional pulling	5195384 NECC-M-S-R3G8PP-HX-PN															
	Cover cap for bus connection		8090740 NEAC-M-S-BD-R3SCPP															
	Cover cap for bus connection		2873540 CPX-M-AK-D															
	Cover for DIL switches		548754 CPX-M-AK-M															
User documentation																		
	Description electronics, CPX bus node	<table border="1"> <tr> <td>German</td> <td>548759</td> <td>CPX-(M)-FB33_35/43_45-DE</td> </tr> <tr> <td>English</td> <td>548760</td> <td>CPX-(M)-FB33_35/43_45-EN</td> </tr> <tr> <td>Spanish</td> <td>548761</td> <td>CPX-(M)-FB33_35/43_45-ES</td> </tr> <tr> <td>French</td> <td>548762</td> <td>CPX-(M)-FB33_35/43_45-FR</td> </tr> <tr> <td>Italian</td> <td>548763</td> <td>CPX-(M)-FB33_35/43_45-IT</td> </tr> </table>	German	548759	CPX-(M)-FB33_35/43_45-DE	English	548760	CPX-(M)-FB33_35/43_45-EN	Spanish	548761	CPX-(M)-FB33_35/43_45-ES	French	548762	CPX-(M)-FB33_35/43_45-FR	Italian	548763	CPX-(M)-FB33_35/43_45-IT	
German	548759	CPX-(M)-FB33_35/43_45-DE																
English	548760	CPX-(M)-FB33_35/43_45-EN																
Spanish	548761	CPX-(M)-FB33_35/43_45-ES																
French	548762	CPX-(M)-FB33_35/43_45-FR																
Italian	548763	CPX-(M)-FB33_35/43_45-IT																

Datasheet – PROFINET bus node, push-pull SCRJ



Bus node for operating the CPX valve terminal on PROFINET.
 The bus node is provided with system supply via the interlinking block and processes communication with the I/O modules.
 The status of the CPX terminal is displayed as a common message via 4 CPX-specific LEDs.
 The fieldbus communication status is displayed via three bus-specific LEDs.

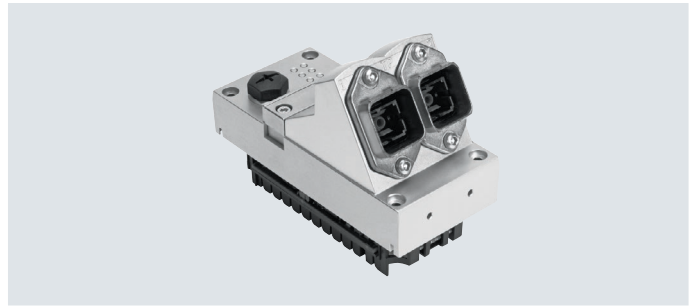

Application

Bus connection

The bus connection is established via SCRJ push-pull sockets to IEC 61754-24 (fibre-optic cable, AIDA standard) with degree of protection IP65, IP67.

The connections on the CPX bus node are equivalent 100BaseFX Ethernet ports that are brought together via an internal switch.

Fibre-optic cables made from plastic (POF, 980/1000 µm) are also suitable for transmission.

- Maximum segment length 50 m
- Transmission rate 100 Mbps
- Supports LLDP and SNMP

PROFINET implementation

The bus nodes support the PROFINET protocol on the basis of the Ethernet standard and TCP/IP technology to IEEE802.3.

This guarantees a data exchange with a high data transmission rate, for example I/O data from sensors, actuators or robot controllers, PLCs or process equipment. In addition, non-real-time critical information such as diagnostic

information, configuration information, etc. can be transferred.

The Ethernet bandwidth is sufficient to transfer both data types (real-time and non-real-time) in parallel.

The bus node features LEDs for bus status and CPX peripheral information as well as switch elements and a diagnostic interface. PROFINET provides the

user with access to all peripheral, diagnostic and parameter data for the CPX valve terminal. The bus node can be used as a remote I/O or remote controller. All information relevant to the CPX can be read out and, dependent on the function, changed via CPX-FMT.

Points to note in connection with CPX-CEC

When a bus node is combined with a control block (CPX-CEC, in the fieldbus remote controller operating mode), the connected I/Os and/or valves, sensors and actuators are controlled via the CPX control block.

In this case, the bus node only provides the communication interface to the PLC.

Communication between the control block and CPX bus node takes place by linking the CPX modules and takes up

the following address capacity in the CPX system:

- 8/16 byte outputs
- 8/16 byte inputs

The following address capacity remains in the control block or CPX system for activating the peripherals:

- 56/48 byte inputs
- 56/48 byte outputs

Datasheet – PROFINET bus node, push-pull SCRJ

General technical data			
Type	CPX-M-FB45		
Fieldbus interface	2x SCRJ push-pull socket, AIDA		
Baud rate	[Mbps]	100	
Protocol	PROFINET RT PROFINET IRT		
Max. address capacity	Inputs	[byte]	64
	Outputs	[byte]	64
LED indicators	(bus-specific)		M/P = Maintenance/PROFenergy NF = Network error TP1 = Network active, port 1 TP2 = Network active, port 2
	(product-specific)		M = Modify, parameterisation PL = Load supply PS = Electronic supply, sensor supply SF = System error
Device-specific diagnostics	<ul style="list-style-type: none"> • Channel and module-oriented diagnostics • Undervoltage of modules • Diagnostics memory 		
Configuration support	GSDML file		
Parameterisation	<ul style="list-style-type: none"> • System parameters • Diagnostic behaviour • Signal setup • Fail-safe response • Forcing of channels 		
Additional functions	<ul style="list-style-type: none"> • Start-up parameterisation in plain text via fieldbus • Fast start-up (FSU) • Channel-oriented diagnostics via fieldbus • Acyclic data access via fieldbus and via Ethernet • System status can be displayed using process data • Additional diagnostic interface for operator unit 		
	<ul style="list-style-type: none"> • I&M • LLDP • MRP • MRPD • MQTT • PROFI-safe • PROFenergy • S2 system redundancy 		
Control elements	DIL switches		
Operating voltage	Nominal width	[V DC]	24
	Permissible range	[V DC]	18 ... 30
Intrinsic current consumption at nominal operating voltage	[mA]	Typ. 145	
Certification	RCM		
Degree of protection to EN 60529	IP65, IP67		
Temperature range	Operation	[°C]	-5... +50
	Storage/transport	[°C]	-20 ... +70
Material information: Housing	Die-cast aluminium		
Note on materials	RoHS-compliant		
LABS (PWIS) conformity	VDMA24364-B2-L		
Grid dimension	[mm]	50	
Dimensions (including interlinking block) W x L x H	[mm]	50 x 107 x 80	
Product weight	[g]	280	

 **Note**

Please observe the general limits and guidelines for the system when configuring the electric modules.

 **Note**

Always use the correct screws for the interlinking block; this depends on whether the block is made of metal or polymer:

- Self-tapping screws for polymer interlinking blocks
- Screws with metric thread for metal interlinking blocks

Datasheet – PROFINET bus node, push-pull SCRJ

Connection and display components

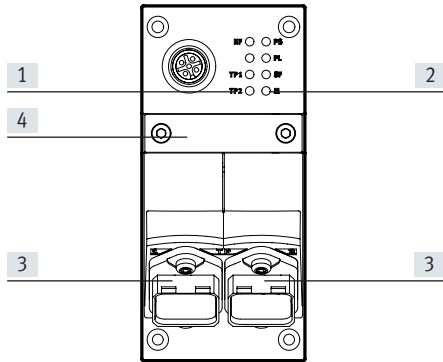





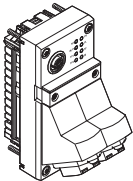

- [1] Bus-specific status LEDs
- [2] CPX-specific status LEDs
- [3] Fieldbus interface (SCRJ) socket, 2-pin)
- [4] DIL switch

Pin assignment for the fieldbus interface

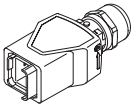
Terminal assignment	Pin	Signal	Designation
Socket SCRJ			
	1	Tx	Outgoing
	2	Rx	Incoming

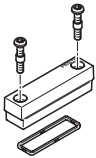
Datasheet – PROFINET bus node, push-pull SCRJ

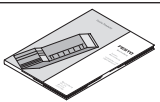
Ordering data		Part no.	Type
Designation			
Bus node			
	2x SCRJ push-pull socket, AIDA	<ul style="list-style-type: none"> • I&M • LLDP • MRP • MRPD • PROFIenergy • S2 system redundancy 	8110371 CPX-M-FB45
Bus connection			
	SC-RJ connector to IEC 61754-24, 2-pin	Push-pull with locking mechanism against unintentional pulling	5195381 NOCC-M-S-SCRJG2PP-C5-PN
	Cover cap for bus connection		8090740 NEAC-M-S-BD-R3SCPP
	Cover cap for bus connection		2873540 CPX-M-AK-D
	Cover for DIL switches		548754 CPX-M-AK-M
	Screws for attaching an inscription label to the bus node (pack of 12)		550222 CPX-M-M2.5X8-12X
	Adapter M12, 5-pin to mini USB socket, and controller software		547432 NEFC-M12G5-0.3-U1G5
User documentation			
	Description electronics, CPX bus node	German	548759 CPX-(M)-FB33_35/43_45-DE
		English	548760 CPX-(M)-FB33_35/43_45-EN
		Spanish	548761 CPX-(M)-FB33_35/43_45-ES
		French	548762 CPX-(M)-FB33_35/43_45-FR
		Italian	548763 CPX-(M)-FB33_35/43_45-IT

Datasheet – EtherNet/IP bus node

- Industrial Ethernet
- EtherNet/IP
- Web interface

Bus node for handling communication between the electrical terminal CPX and the Ethernet/IP network.

The bus node is provided with system supply via the interlinking block and processes communication with the I/O modules.

The status of the CPX terminal is displayed as a common message via 4 CPX-specific LEDs.

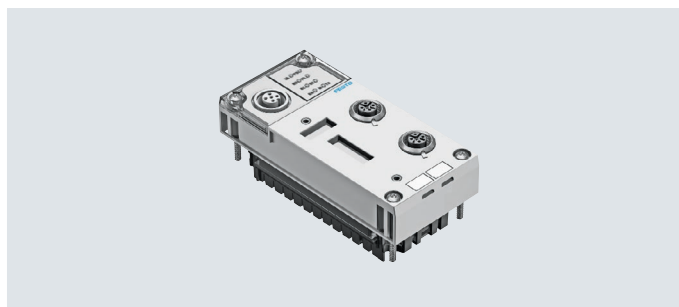

Application

Bus connection

The bus connection is established via an M12 plug, D-coded to IEC 947-5-2 with degree of protection IP65, IP67.

EtherNet/IP is an open bus system based on the Ethernet standard and TCP/IP technology (IEEE802.3).

EtherNet/IP implementation

The CPX-FB36 supports the two operating modes: remote I/O and remote controller.

In remote I/O operating mode, all functions of the CPX valve terminal are dir-

ectly controlled by the Ethernet/IP master (host).

In addition to activation via a bus system, it is possible to use IT technologies. An integrated web server enables diagnostic data to be visualised via

HTML. Various programs support direct access to the device data from the automation network.

The Ethernet/IP node for CPX supports the transmission technology that con-

forms to DIN EN 50173/CAT 5 as an integrated interface.

Points to note in connection with CPX-CEC

When a bus node is combined with a control block (CPX-CEC, in the fieldbus remote controller operating mode), the connected I/Os and/or valves, sensors and actuators are controlled via the CPX control block.

In this case, the bus node only provides the communication interface to the PLC.

Communication between the control block and CPX bus node takes place by linking the CPX modules and takes up

the following address capacity in the CPX system:

- 8 byte outputs
- 8 byte inputs

The following address capacity remains in the control block or CPX system for activating the peripherals:

- 56 byte inputs
- 56 byte outputs

Datasheet – EtherNet/IP bus node

General technical data			
Type	CPX-FB36		
Fieldbus interface	2x socket M12x1, 4-pin, D-coded		
Baud rates	[Mbps]	10/100	
Protocol	EtherNet/IP Modbus TCP		
Max. address capacity, inputs	[byte]	64	
Max. address capacity, outputs	[byte]	64	
LED displays (bus-specific)	MS = Module status NS = Network status TP1 = Network active, port 1 TP2 = Network active, port 2		
Device-specific diagnostics	<ul style="list-style-type: none"> • Module and channel-oriented diagnostics • Undervoltage of modules • Diagnostic memory 		
Configuration support	<ul style="list-style-type: none"> • EDS file • L5K export with CPX-FMT 		
Parameterisation	<ul style="list-style-type: none"> • Diagnostic behaviour • Fail-safe response • Forcing of channels • Idle mode characteristics • Signal setup • System parameters 		
Additional functions	<ul style="list-style-type: none"> • EtherNet/IP Quickconnect • Ring topology (DLR) • Acyclic data access via "Explicit Message" and Ethernet • Integrated switch • - IP addressing via DHCP, DIL switch or operator unit • Channel-oriented diagnostics via fieldbus • Start-up parameterisation in plain text via fieldbus • System status can be displayed using process data • Additional diagnostic interface for operator units 		
Control elements	DIL switches		
Operating voltage	Nominal width	[V DC]	24
	Permissible range	[V DC]	18 ... 30
Current consumption at nominal voltage		[mA]	Typically 100
Degree of protection to EN 60529	IP65, IP67		
Temperature range	Operation	[°C]	- 5... +50
	Storage/transport	[°C]	-20 ... +70
Materials	Reinforced PA		
Note on materials	RoHS-compliant		
LABS (PWIS) conformity	VDMA24364-B2-L		
Grid dimension		[mm]	50
Dimensions (including interlinking block) W x L x H		[mm]	50 x 107 x 50
Product weight		[g]	125

 **Note**

Please observe the general limits and guidelines for the system when configuring the electrical modules.

Datasheet – EtherNet/IP bus node

Connection and display components

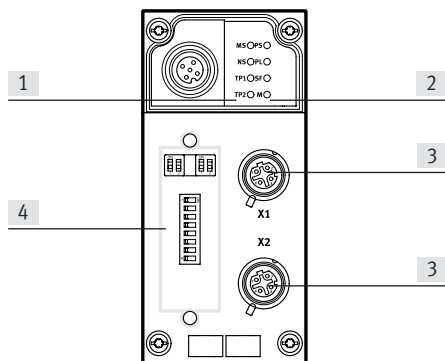



- [1] Bus-specific status LEDs
- [2] CPX-specific status LEDs
- [3] Fieldbus interface (socket M12, 4-pin, D-coded)
- [4] Transparent DIL switch cover

Pin assignment for the fieldbus interface

Terminal assignment	Pin	Signal	Designation
Socket, M12, D-coded			
	1	TD+	Transmitted data+
	2	RD+	Received data+
	3	TD-	Transmitted data-
	4	RD-	Received data-
	Housing	FE	Shielding

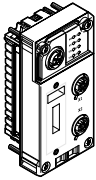
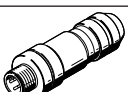
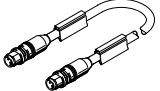
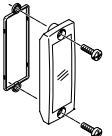
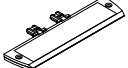
Datasheet – EtherNet/IP bus node

Ordering data					
Designation		Part no.	Type		
Bus node					
	EtherNet/IP bus node	1912451	CPX-FB36		
Bus connection					
	Plug M12x1, 4-pin, D-coded	543109	NECU-M-S-D12G4-C2-ET		
	Connecting cable, straight plug, M12x1, 4-pin, D-coded	Straight plug, M12x1, 4-pin, D-coded	0.5 m	8040446	NEBC-D12G4-ES-0.5-S-D12G4-ET
			1 m	8040447	NEBC-D12G4-ES-1-S-D12G4-ET
			3 m	8040448	NEBC-D12G4-ES-3-S-D12G4-ET
			5 m	8040449	NEBC-D12G4-ES-5-S-D12G4-ET
			10 m	8040450	NEBC-D12G4-ES-10-S-D12G4-ET
	Straight plug, RJ45, 8-pin	1 m	8040451	NEBC-D12G4-ES-1-S-R3G4-ET	
		3 m	8040452	NEBC-D12G4-ES-3-S-R3G4-ET	
		5 m	8040453	NEBC-D12G4-ES-5-S-R3G4-ET	
	10 m	8040454	NEBC-D12G4-ES-10-S-R3G4-ET		
Open end, 4-core	5 m	8040456	NEBC-LE4-ES-5-D12G4-ET		
	Inspection cover, transparent	533334	AK-SUB-9/15-B		
	Inscription label holder for connection block	536593	CPX-ST-1		
	Adapter M12, 5-pin to mini USB socket, and controller software	547432	NEFC-M12G5-0.3-U1G5		
User documentation					
	User documentation for bus node CPX-FB36	German	8024074	CPX-FB36-DE	
		English	8024075	CPX-FB36-EN	

Datasheet – EtherCAT® bus node



Bus node for operating the CPX valve terminal on EtherCAT.
 The bus node is provided with system supply via the interlinking block and processes communication with the I/O modules.
 The status of the CPX terminal is displayed as a common message via 4 CPX-specific LEDs.
 The status of the fieldbus communication is displayed via 4 bus-specific LEDs.

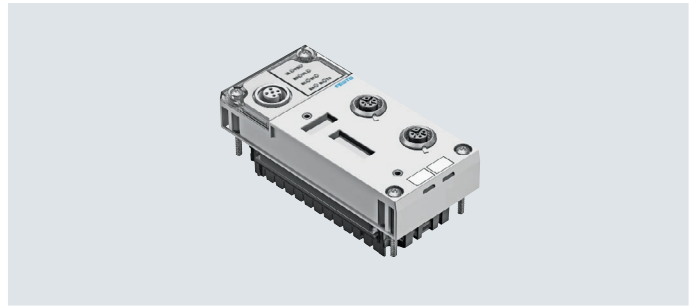

Application

Bus connection

The bus connection is established via two sockets M12x1, D-coded to IEC 61076-2-101 with degree of protection IP65, IP67.

Both connections are equivalent 100BaseTX Ethernet ports with integrated auto MDI functionality (cross-over and patch cable can be used) that are brought together via an internal switch.

- Maximum segment length 100 m
- Transmission rate 100 Mbps

EtherCAT® implementation

The CPX-FB37 supports the EtherCAT protocol on the basis of the Ethernet standard and TCP/IP technology to IEEE802.3.
 This guarantees a data exchange with a high data transmission rate, for example I/O data from sensors, actuators or robot controllers, PLCs or process equipment. In addition, non-real-time critical information such as diagnostic information, configuration information, etc. can be transferred.
 The data bandwidth is sufficient to transfer both data types (real-time and non-real-time) in parallel.

The bus node features LEDs for bus status and CPX peripheral information as well as switch elements and a diagnostic interface. The bus node can be used as a remote I/O or remote controller. All information relevant to the CPX can be read out and, dependent on the function, changed via CPX-FMT.
 The functions MDP (modular device profile) and CoE (CAN over EtherCAT®) enable easy access to parameters and diagnostic data via EtherCAT.

Specific EtherCAT® functions:

- CoE (parameters and diagnostics or fail-safe mode): all module parameters can be set
- FoE (file over EtherCAT) makes it possible to download firmware easily
- EoE (Ethernet over EtherCAT): diagnostic data can be retrieved easily using a browser
- MDP (modular device profile): easy configuration using a module selection box
- Hot connect, easy replacement of an EtherCAT CPX terminal
- DC (distributed clocks), time-synchronised data transmission

Points to note in connection with CPX-CEC

When a bus node is combined with a control block (CPX-CEC, in the fieldbus remote controller operating mode), the connected I/Os and/or valves, sensors and actuators are controlled via the CPX control block.

In this case, the bus node only provides the communication interface to the PLC.
 Communication between the control block and CPX bus node takes place by linking the CPX modules and takes up

the following address capacity in the CPX system:
 • 8/16 byte outputs
 • 8/16 byte inputs
 The following address capacity remains in the control block or CPX system for activating the peripherals:

- 56/48 byte inputs
- 56/48 byte outputs

Datasheet – EtherCAT® bus node

General technical data			
Type	CPX-FB37		
Fieldbus interface	2x socket M12x1, 4-pin, D-coded		
Baud rates	[Mbps]	100	
Protocol	EtherCAT®		
Max. address capacity	Inputs	[byte]	64
	Outputs	[byte]	64
LED indicators	Bus-specific		Error = Communication error L/A1 = Network active port 1 L/A2 = Network active port 2 Run = Communication status
	Product-specific		M = Modify, parameterisation PL = Load supply PS = Electronic supply, sensor supply SF = System error
Device-specific diagnostics	<ul style="list-style-type: none"> Channel and module-oriented diagnostics Undervoltage of modules Diagnostics memory 		
Configuration support	ESI file		
Parameterisation	<ul style="list-style-type: none"> System parameters Diagnostic behaviour Signal setup Fail-safe response Forcing of channels 		
Additional functions	<ul style="list-style-type: none"> System status can be displayed using process data Additional diagnostic interface for operator units Emergency message Acyclic data access via fieldbus Diagnostics object Compatibility mode with CPX-FB38 Modular device profile (MDP) Variable PDO mapping 		
Control elements	DIL switches		
Operating voltage	Nominal width	[V DC]	24
	Permissible range	[V DC]	18 ... 30
Current consumption			[mA] Typically 100
Degree of protection to EN 60529	IP65, IP67		
Temperature range	Operation	[°C]	-5... +50
	Storage/transport	[°C]	-20 ... +70
Materials	Housing		Reinforced PA
Note on materials	RoHS-compliant		
LABS (PWIS) conformity	VDMA24364-B2-L		
Grid dimension			[mm] 50
Dimensions (including interlinking block) W x L x H			[mm] 50 x 107 x 50
Product weight			[g] 125

 **Note**

Please observe the general limits and guidelines for the system when configuring the electrical modules.

 **Note**

Always use the correct screws for the interlinking block; this depends on whether the block is made of metal or polymer:

- Self-tapping screws for polymer interlinking blocks
- Screws with metric thread for metal interlinking blocks

Datasheet – EtherCAT® bus node

Connection and display components

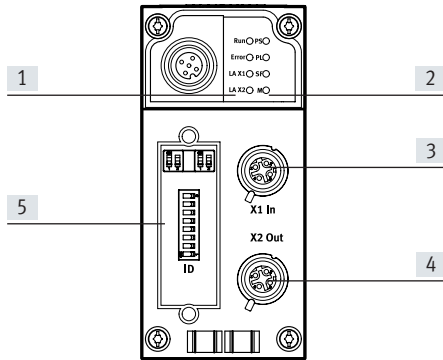





- [1] Bus-specific status LEDs
- [2] CPX-specific status LEDs
- [3] Fieldbus interface, input (socket M12x1, 4-pin, D-coded)
- [4] Fieldbus interface, output (socket M12x1, 4-pin, D-coded)
- [5] DIL switch

Pin assignment for the fieldbus interface

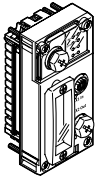
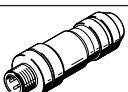
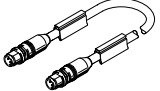
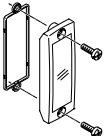
Terminal assignment	Pin	Signal	Designation
Socket M12x1, D-coded			
	1	TD+	Transmitted data+
	2	RD+	Received data+
	3	TD-	Transmitted data-
	4	RD-	Received data-
	Housing	FE	Shielding

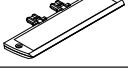
Datasheet – EtherCAT® bus node

Ordering data					
Designation		Part no.	Type		
Bus node					
	EtherCAT® bus node	2735960	CPX-FB37		
Bus connection					
	Plug M12x1, 4-pin, D-coded	543109	NECU-M-S-D12G4-C2-ET		
	Connecting cable, straight plug, M12x1, 4-pin, D-coded	Straight plug, M12x1, 4-pin, D-coded	0.5 m	8040446	NEBC-D12G4-ES-0.5-S-D12G4-ET
			1 m	8040447	NEBC-D12G4-ES-1-S-D12G4-ET
			3 m	8040448	NEBC-D12G4-ES-3-S-D12G4-ET
			5 m	8040449	NEBC-D12G4-ES-5-S-D12G4-ET
			10 m	8040450	NEBC-D12G4-ES-10-S-D12G4-ET
		Straight plug, RJ45, 8-pin	1 m	8040451	NEBC-D12G4-ES-1-S-R3G4-ET
			3 m	8040452	NEBC-D12G4-ES-3-S-R3G4-ET
5 m	8040453		NEBC-D12G4-ES-5-S-R3G4-ET		
Open end, 4-core	10 m	8040454	NEBC-D12G4-ES-10-S-R3G4-ET		
	5 m	8040456	NEBC-LE4-ES-5-D12G4-ET		
	Inspection cover, transparent	533334	AK-SUB-9/15-B		
	Cover cap for sealing unused bus connections (10 pieces)	165592	ISK-M12		
	Inscription label holder for connection block	536593	CPX-ST-1		
	Adapter M12, 5-pin to mini USB socket, and controller software	547432	NEFC-M12G5-0.3-U1G5		
User documentation					
	Description electronics, CPX bus node, type CPX-FB37	German	8029674	CPX-FB37-DE	
		English	8029675	CPX-FB37-EN	

Datasheet – Sercos III bus node

- Sercos
- Web interface

Bus node for handling communication between the electrical terminal CPX and the Sercos III network.

The bus node is provided with system supply via the interlinking block and processes communication with the I/O modules.

The status of the CPX terminal is displayed as a common message via 4 CPX-specific LEDs.

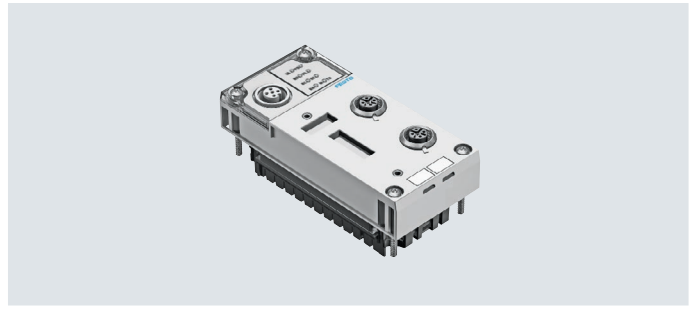

Application

Bus connection

The bus connection is established via two plugs M12x1, D-coded to IEC 947-5-2 with degree of protection to IP65, IP67. The connections are equipped with automatic detection for the incoming and outgoing connection.

The Sercos III bus node can be used to connect the CPX valve terminal to the standardised Sercos III bus.

Sercos III uses the Ethernet standard (IEEE802.3) and TCP/IP technology for communication in an industrial environment.

Industry-compatible Sercos III devices enable data to be exchanged with a higher data transmission rate, such as data from sensors, actuators or controllers.

Non-real-time critical information, such as diagnostics or configuration information, can also be transferred.

Webserver

In addition to activation via a bus system, it is possible to use IT technologies. An integrated web server enables

diagnostic data to be visualised via HTML. Various programs support direct

access to the device data from the automation network.

Points to note in connection with CPX-CEC

The CPX-FB39 supports the operating modes remote I/O and remote controller.

In remote I/O operating mode, all functions of the CPX valve terminal are directly controlled by the Sercos controller.

When a bus node is combined with a control block (CPX-CEC, in the fieldbus

remote controller operating mode), the connected I/Os and/or valves, sensors and actuators are controlled via the CPX control block.

In this case, the bus node only provides the communication interface to the PLC.

Communication between the control block and CPX bus node takes place by

linking the CPX modules and takes up the following address capacity in the CPX system:

- 8/16 byte outputs
- 8/16 byte inputs

The following address capacity remains in the control block or CPX system for activating the peripherals:

- 56/48 byte inputs

- 56/48 byte outputs

Datasheet – Sercos III bus node

General technical data			
Type	CPX-FB39		
Fieldbus interface	2x M12x1 socket, D-coded, 4-pin		
Baud rates	[Mbps]	100 full/half duplex	
Protocol	Sercos III		
Max. address capacity	Inputs	[byte]	64
	Outputs	[byte]	64
LED indicators	Bus-specific		S = Sercos LED SD = Sercos sub-device LED TP1 = Network active, port 1 TP2 = Network active, port 2
	Product-specific		M = Modify, parameterisation PL = Load supply PS = Electronics supply, sensor supply SF = System error
Device-specific diagnostics	<ul style="list-style-type: none"> Module and channel-oriented diagnostics Undervoltage of modules Diagnostic memory 		
Configuration support	SDDML file		
Parameterisation	<ul style="list-style-type: none"> Diagnostic behaviour Fallback output data Forcing of channels Signal setup System parameters 		
Additional functions	<ul style="list-style-type: none"> Acyclic and cyclic data access via Sercos IP addressing via Sercos parameters or operator unit Channel-oriented diagnostics via fieldbus Start-up parameterisation in plain text via fieldbus System status can be displayed using process data Additional diagnostic interface for operator units 		
Control elements	DIL switches		
Operating voltage	Nominal width	[V DC]	24
	Permissible range	[V DC]	18 ... 30
Current consumption at nominal voltage			[mA] Typically 100
Degree of protection to EN 60529	IP65, IP67		
Temperature range	Operation	[°C]	-5... +50
	Storage/transport	[°C]	-20 ... +70
Materials	Reinforced PA		
Note on materials	RoHS-compliant		
LABS (PWIS) conformity	VDMA24364-B2-L		
Grid dimension			[mm] 50
Dimensions (including interlinking block) W x L x H			[mm] 50 x 107 x 50
Product weight			[g] 125

 **Note**

Please observe the general limits and guidelines for the system when configuring the electrical modules.

Datasheet – Sercos III bus node

Connection and display components

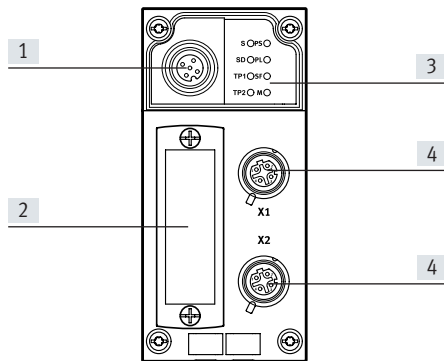

- [1] Service interface for PC with CPX maintenance tool NEFC-M12G5-0.3-U1G5
- [2] Transparent DIL switch cover
- [3] Status LED, bus-specific and CPX-specific
- [4] Fieldbus interface (socket M12x1, 4-pin, D-coded)



Pin assignment for the fieldbus interface

Terminal assignment	Pin	Signal	Designation
Socket M12x1, D-coded			
	1	TD+	Transmitted data+
	2	RD+	Received data+
	3	TD-	Transmitted data-
	4	RD-	Received data-
	Housing	FE	Shielding

Note

The CPX-FB39 can automatically detect transmitter and receiver cables (auto-MDI/MDI-X auto-cross-over). RD and TD signal pairs are automatically swapped if required.

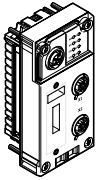
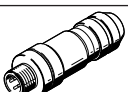
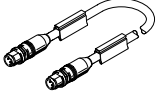
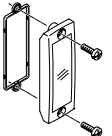
Datasheet – Sercos III bus node

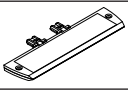
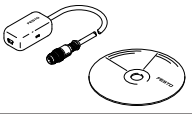
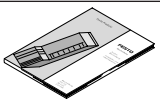
Ordering data				Part no.	Type
Designation					
Bus node					
	Ethernet Sercos III bus node			2093101	CPX-FB39
Bus connection					
	Plug M12x1, 4-pin, D-coded			543109	NECU-M-S-D12G4-C2-ET
	Connecting cable, straight plug, M12x1, 4-pin, D-coded	Straight plug, M12x1, 4-pin, D-coded	0.5 m	8040446	NEBC-D12G4-ES-0.5-S-D12G4-ET
			1 m	8040447	NEBC-D12G4-ES-1-S-D12G4-ET
			3 m	8040448	NEBC-D12G4-ES-3-S-D12G4-ET
			5 m	8040449	NEBC-D12G4-ES-5-S-D12G4-ET
			10 m	8040450	NEBC-D12G4-ES-10-S-D12G4-ET
		Straight plug, RJ45, 8-pin	1 m	8040451	NEBC-D12G4-ES-1-S-R3G4-ET
			3 m	8040452	NEBC-D12G4-ES-3-S-R3G4-ET
			5 m	8040453	NEBC-D12G4-ES-5-S-R3G4-ET
Open end, 4-core	10 m	8040454	NEBC-D12G4-ES-10-S-R3G4-ET		
	5 m	8040456	NEBC-LE4-ES-5-D12G4-ET		
	Inspection cover, transparent			533334	AK-SUB-9/15-B
	Cover cap for sealing unused bus connections (10 pieces)			165592	ISK-M12
	Inscription label holder for connection block			536593	CPX-ST-1
	Adapter M12, 5-pin to mini USB socket, and controller software			547432	NEFC-M12G5-0.3-U1G5
User documentation					
	User documentation for bus node CPX-FB39	German	8028632	CPX-FB39-DE	
		English	8028633	CPX-FB39-EN	

Datasheet – POWERLINK bus node

- Ethernet POWERLINK
- Web interface

Bus node for handling communication between the electrical terminal CPX and the Ethernet POWERLINK network. The bus node is provided with system supply via the interlinking block and processes communication with the I/O modules.

The status of the CPX terminal is displayed as a common message via 4 CPX-specific LEDs.

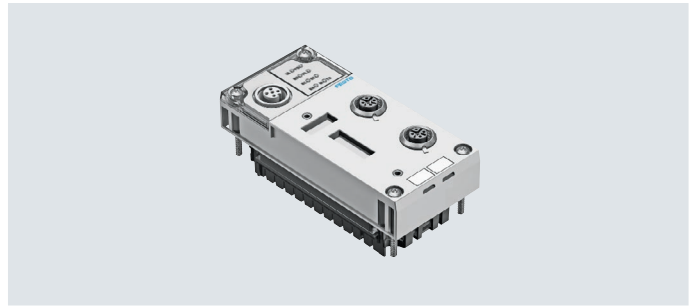

Application

Bus connection

The bus connection is established via an M12x1 plug, D-coded to IEC 947-5-2 with degree of protection IP65, IP67. Ethernet POWERLINK uses the Ethernet standards and TCP/IP technology (IEEE802.3) for communication in an industrial environment and integrates all CANopen mechanisms.

It includes all the key features of standard Ethernet, including internode communication, hotplug capability and free selection of network topology. Ethernet POWERLINK fulfils the real-time requirements using a mix of timeslot and polling procedures. In other words, defined times are re-

served on the Ethernet cable exclusively for transferring real-time data. Only network participants which have previously been prompted by the controller are able to transmit data during these timeslots.

Ethernet POWERLINK implementation

The CPX-FB40 supports the two operating modes: remote I/O and remote controller. In remote I/O operating mode, all functions of the CPX valve terminal are dir-

ectly controlled by the Ethernet POWERLINK master (host). In addition to activation via a bus system, it is possible to use IT technologies. An integrated web server enables diagnostic data to be visualised via

HTML. Various programs support direct access to the device data from the automation network. The Ethernet POWERLINK node for CPX supports the transmission technology

that conforms to DIN EN 50173/CAT 5 as an integrated interface.

Points to note in connection with CPX-CEC

When a bus node is combined with a control block (CPX-CEC, in the fieldbus remote controller operating mode), the connected I/Os and/or valves, sensors and actuators are controlled via the CPX control block.

In this case, the bus node only provides the communication interface to the PLC. Communication between the control block and CPX bus node takes place by linking the CPX modules and takes up

the following address capacity in the CPX system:

- 8 byte outputs
- 8 byte inputs

The following address capacity remains in the control block or CPX system for activating the peripherals:

- 56 byte inputs
- 56 byte outputs

Datasheet – POWERLINK bus node

General technical data		
Type		CPX-FB40
Fieldbus interface		2x M12x1 socket, D-coded, 4-pin
Baud rates	[Mbps]	100
Protocol		Ethernet POWERLINK V2
Max. address capacity	Inputs	[byte] 64
	Outputs	[byte] 64
LED indicators	Bus-specific	BE = POWERLINK error BS = POWERLINK status L/A1 = Link/activity port 1 L/A2 = Link/activity port 2
	Product-specific	M = Modify, parameterisation PL = Load supply PS = Electronic supply, sensor supply SF = System error
Device-specific diagnostics		<ul style="list-style-type: none"> • Module and channel-oriented diagnostics • Undervoltage of modules • Diagnostic memory
Configuration support		<ul style="list-style-type: none"> • XDC file • XDD file
Parameterisation		<ul style="list-style-type: none"> • Diagnostic behaviour • Fail-safe response • Forcing of channels • Signal setup • System parameters
Additional functions		<ul style="list-style-type: none"> • Acyclic data access via "SDO" and Ethernet • Integrated hub • - IP addressing via DHCP, DIL switch or operator unit • Channel-oriented diagnostics via fieldbus • Start-up parameterisation in plain text via fieldbus • System status can be displayed using process data • Additional diagnostic interface for operator units
Control elements		DIL switches
Operating voltage	Nominal width	[V DC] 24
	Permissible range	[V DC] 18 ... 30
	Reverse polarity protection	For operating voltage
Current consumption at nominal voltage	[mA]	Typically 100
Degree of protection to EN 60529		IP65, IP67
Temperature range	Operation	[°C] - 5... +50
	Storage/transport	[°C] -20 ... +70
Materials		Reinforced PA
Note on materials		RoHs-compliant
LABS (PWIS) conformity		VDMA24364-B2-L
Grid dimension	[mm]	50
Dimensions (including interlinking block) W x L x H	[mm]	50 x 107 x 50
Product weight	[g]	125

 **Note**

Please observe the general limits and guidelines for the system when configuring the electrical modules.

Datasheet – POWERLINK bus node

Connection and display components

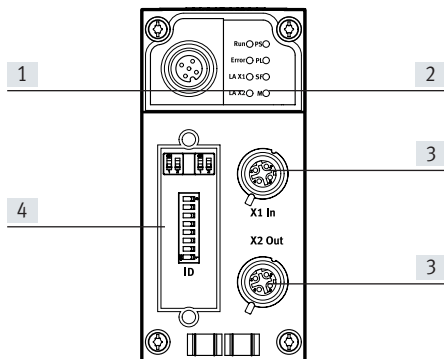



- [1] Bus-specific status LEDs
- [2] CPX-specific status LEDs
- [3] Fieldbus interface (socket M12x1, 4-pin, D-coded)
- [4] Transparent DIL switch cover

Pin assignment for the fieldbus interface

Terminal assignment	Pin	Signal	Designation
Socket M12x1, D-coded			
	1	TD+	Transmitted data+
	2	RD+	Received data+
	3	TD-	Transmitted data-
	4	RD-	Received data-
	Housing	FE	Shielding

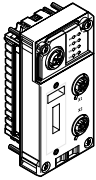
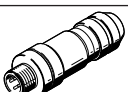
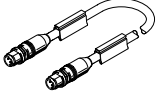
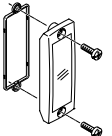
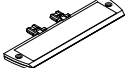
Datasheet – POWERLINK bus node

Ordering data					
Designation		Part no.	Type		
Bus node					
	Ethernet POWERLINK bus node	2474896	CPX-FB40		
Bus connection					
	Plug M12x1, 4-pin, D-coded	543109	NECU-M-S-D12G4-C2-ET		
	Connecting cable, straight plug, M12x1, 4-pin, D-coded	Straight plug, M12x1, 4-pin, D-coded	0.5 m	8040446	NEBC-D12G4-ES-0.5-S-D12G4-ET
			1 m	8040447	NEBC-D12G4-ES-1-S-D12G4-ET
			3 m	8040448	NEBC-D12G4-ES-3-S-D12G4-ET
			5 m	8040449	NEBC-D12G4-ES-5-S-D12G4-ET
			10 m	8040450	NEBC-D12G4-ES-10-S-D12G4-ET
	Straight plug, RJ45, 8-pin	1 m	8040451	NEBC-D12G4-ES-1-S-R3G4-ET	
		3 m	8040452	NEBC-D12G4-ES-3-S-R3G4-ET	
		5 m	8040453	NEBC-D12G4-ES-5-S-R3G4-ET	
Open end, 4-core	10 m	8040454	NEBC-D12G4-ES-10-S-R3G4-ET		
5 m	8040456	NEBC-LE4-ES-5-D12G4-ET			
	Inspection cover, transparent	533334	AK-SUB-9/15-B		
	Inscription label holder for connection block	536593	CPX-ST-1		
	Adapter M12, 5-pin to mini USB socket, and controller software	547432	NEFC-M12G5-0.3-U1G5		
User documentation					
	User documentation for bus node CPX-FB40	German	8028650	CPX-FB40-DE	
		English	8028651	CPX-FB40-EN	

Datasheet – Interface for CPI system

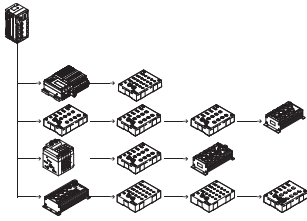

The electrical interface CPX-CP establishes the connection to CP modules of the installation system CPI via pre-assembled connecting cables. The I/O data of the connected valve terminals with CP string extension and CP input and output modules are transferred to the connected CPX bus node and thus via fieldbus to the higher-order controller.

This enables modular centralised and compact decentralised concepts to be established with one system.



Application

CP connection

As well as transmitting the communication data, the max. 4 CP strings of a CPX-CP interface also transmit the power supply to the connected sensors and the load supply to the valves (or outputs). Both circuits are supplied separately with 24 V but using a common reference potential.

The valve terminals with CP string extension (or outputs) are supplied with voltage for the electronics and valves by the interlinking block.

The CP interface allows the following combinations:

- Centralised analogue and digital inputs and outputs of the CPX terminal
- Decentralised digital inputs and outputs of the CP installation system
- Valve/valve terminals that can be connected both centrally and decentraly

Configuration example – CP interface with CP modules

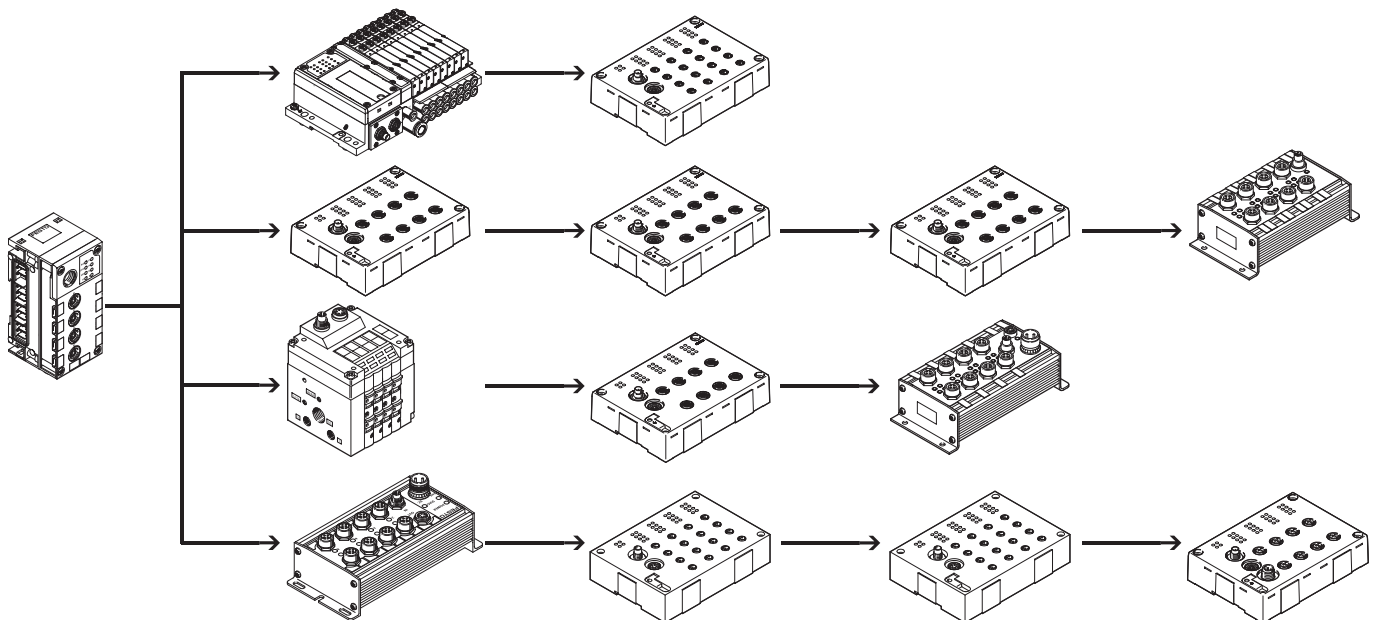

Datasheet – Interface for CPI system

Implementation

The CPX-CP interface supports the CPI system:

- Max. 4 individual electronically protected CP strings
- Max. 4 CP modules per string
- Max. 32 inputs/32 outputs per string
- The maximum length of a string is 10 m. If the CP interface is positioned centrally, the CP system can cover an area of 20 m in diameter.
- Modules with CPI functionality

The following CP module variants are available:

- Input modules with 8 or 16 digital inputs (connection technology M8 and M12)
- Output modules with 4 or 8 digital outputs (connection technology M12)
- Valve terminals with CP string extension (up to 32 solenoid coils, different valve functions)

CPI modules support the following functions:

- Module-oriented diagnostics
- Module/channel-oriented parameterisation
- Support of all functions by the CPX-FMT
- Module can be positioned anywhere within the string

Several CP interface modules can be combined in one CPX terminal, depending on the address capacity of the bus node.

Example:

- CPX-FB13 (512 I/O)
- Max. 4 CP interface modules (128 I/Os each) possible

Note

When arranging the CP modules it should be taken into consideration that CP input modules without CPI functionality should always be placed at the end of a string.

Configuration

The following rules apply for a string of a CPX-CP interface:

- Max. one output module or one valve terminal without CPI functionality
- Max. one output module without CPI functionality or one valve terminal with CP string extension
- Any number of CP modules with CPI functionality, up to the maximum limit of 4 modules and/or 32 inputs/32 outputs per string
- Maximum extension:
- 4 input modules and 4 valve terminals/output modules without CPI functionality
- 16 CP modules with CPI functionality

The configuration of the strings with respect to the module type and position of the modules in the string is entered by activating the SAVE key in the CPX-CP interface and saved there permanently.

Saved data are retained even when the CP interface is isolated from the power supply.

The representation of the CP interface within a CPX terminal and thus at the fieldbus is dependent on the characteristics of the relevant fieldbus system. In addition to input and output addressing, this also applies to the representation of the diagnostics and parameterisation of the CP module and the characteristics of the CPI system.

Note

The remanent saving of configuration data means that changes in the configuration or faulty modules are still displayed even after a voltage failure.



Datasheet – Interface for CPI system

General technical data			
Type	CPX-CP-4-FB		
Brief description	CP interface		
Maximum number of	CP strings		4
	CP modules per string		4
	Outputs per string		32
	Inputs per string		32
CP connection	Socket M9, 5-pin		
Baud rate		[kbps]	1000
Cycle time	CP modules without CPI functionality	[ms]	4
	CP modules with CPI functionality	[ms]	2
LED indicators	L1 ... 4 = Status of the CP string 1 ... 4 PS = Electronics supply, sensor supply PL = Load supply RN = Status of the CP system SF = System error		
Device-specific diagnostics	Via bus node		
Operating voltage	Nominal width	[V DC]	24 (reverse polarity protected)
	Permissible range	[V DC]	18 ... 30
	Power failure buffering	[ms]	20
Supply voltage for sensors		[V DC]	24 ±25% coming from the bus node
Actuator load voltage		[V DC]	24 ±10% coming from the bus node
Current consumption	Without CP modules	[A]	Max. 0.2
	Per CP string	[A]	Max. 1.6
Degree of protection to EN 60529	IP65, IP67		
Temperature range	Operation	[°C]	-5 ... +50
	Storage/transport	[°C]	-20 ... +70
Materials	PA		
LABS (PWIS) conformity	VDMA24364-B2-L		
Grid dimension		[mm]	50
Dimensions (including interlinking block) W x L x H		[mm]	50 x 107 x 45
Product weight		[g]	139

 **Note**

Please observe the general limits and guidelines for the system when configuring the electric modules.

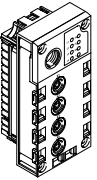
Datasheet – Interface for CPI system

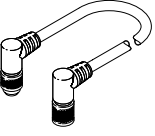
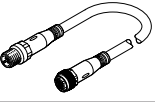
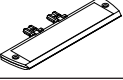
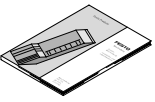
Ordering data				
Designation			Part no.	Type
CP interface				
	Interface for max. 16 I/O modules and valve terminals of the CPI system		526705	CPX-CP-4-FB
Bus connection				
	Cover cap	M12	165592	ISK-M12
	Connecting cable, angled plug, angled socket	0.25 m	540327	KVI-CP-3-WS-WD-0.25
		0.5 m	540328	KVI-CP-3-WS-WD-0.5
		2 m	540329	KVI-CP-3-WS-WD-2
		5 m	540330	KVI-CP-3-WS-WD-5
		8 m	540331	KVI-CP-3-WS-WD-8
	Connecting cable, straight plug, straight socket	2 m	540332	KVI-CP-3-GS-GD-2
		5 m	540333	KVI-CP-3-GS-GD-5
		8 m	540334	KVI-CP-3-GS-GD-8
	Inscription label holder for connection block		536593	CPX-ST-1
User documentation				
	User documentation for CPX CP interface	German	539293	CPX-CP-4-FB-DE
		English	539294	CPX-CP-4-FB-EN
		Spanish	539295	P.BE-CPX-CP-ES
		French	539296	P.BE-CPX-CP-FR
		Italian	539297	P.BE-CPX-CP-IT

Datasheet – I-Port interface

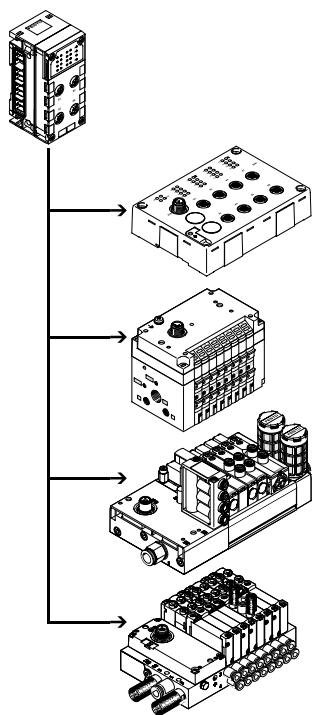

The electrical interface CPX CTEL master establishes the connection to modules of the CTEL/CTEU series that have an I-Port interface (device). The I/O data from the connected devices are transmitted to the connected CPX bus node and thus to the higher-order controller via fieldbus. A maximum of 4 devices can be connected to a CPX CTEL master via corresponding M12 interfaces.



Application

I-Port interface

As well as transmitting the communication data, the I-Port interfaces of a CPX CTEL master also transmit the power supply to the connected sensors and the load supply to the valves (or

outputs). Both circuits are supplied separately with 24 V, using a separate ground.

The connecting cables used must meet the increased requirements resulting

from the dual function as signal cable and supply cable.

Configuration example – CPX CTEL master with CTEL modules

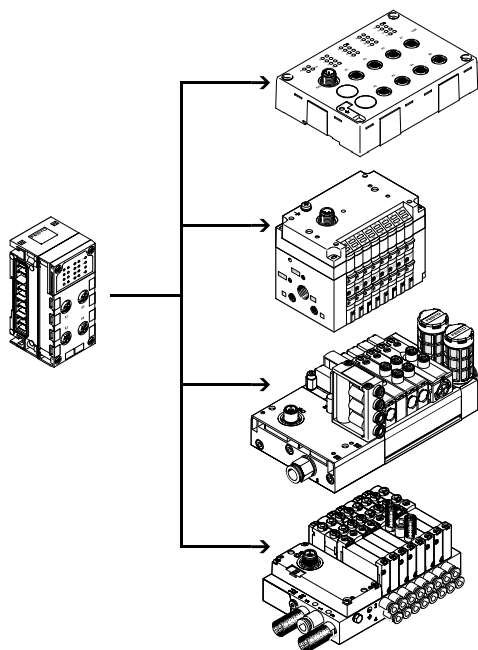

The CPX-CTEL master provides 4 external I-Port interfaces, each of which can be connected to a device. I-Port is an interface for exchanging serial data for connecting decentralised modules or valve terminals from Festo. The I-Port interface is based on IO-Link® and is compatible with it in certain areas. The connection type corresponds to a star topology. In other words, only one module or one valve terminal can be connected to each I-Port.

The restrictions compared to IO-Link® include:

- Permanently set baud rate of 230.4 kbps
- SIO mode is not supported
- Max. 32 bytes of input data and 32 bytes of output data
- Only one dump of the master commands is used
- Configuration via IO-DD is not supported.

Datasheet – I-Port interface

Implementation

The CPX-CTEL master from Festo enables modules with an I-Port interface to be connected to a CPX system:

- Max. 4 devices with individual electronic protection
- Max. 64 inputs/64 outputs per I-Port interface
- The maximum length of a string is 20 m.

The following device variants are available:

- Input modules with 16 digital inputs (connection technology M8 3-pin and M12 5-pin)
- Valve terminals with I-Port interface (up to 48 solenoid coils, different valve functions)

The decentralised layout of the modules and valve terminals with I-Port enables them to be mounted close to the cylinders and actuators or sensors to be controlled. This means that the compressed air supply lines and sensor connecting cables used can be shortened, and it may be possible to use smaller valves, thereby saving costs.

Several CPX CTEL masters can be combined in one CPX terminal, depending on the address capacity of the bus node.

Example:

- CPX-FB13 (512 I/O)
- A maximum of 2 CPX CTEL masters is possible (each with 256 I/O)

Configuration

Settings

The precise number of the I/O bytes made available depends on the requirements of the connected devices or of the relevant selected operating mode.

The operating mode or preset configuration of the CPX CTEL master can be specified by the user.

Selecting the operating mode and setting the manual configuration takes place via the DIL switches. These DIL switches are not required during continuous operation and are only accessible in the disassembled state.

Manual configuration

In the case of manual configuration (tool change mode), the volume of inputs and outputs in the process image of the CPX system or of the higher-order fieldbus can be defined manually using the DIL switches.

The process image then always has the same scope, regardless of the connected devices.

The specified I/O length always applies to all four I-Ports (max. 8 bytes per I-Port).

Automatic configuration

In the case of automatic configuration, the I/O length for each I-Port is determined individually and this value is used to select the appropriate or next highest configuration preset.

Power supply for I-Port devices

The CPX-CTEL master provides two separate power supplies for the connected devices:

- For operating the device and the inputs connected to it
- For the outputs and valves that are connected to the device

The power supply for the devices and the inputs is provided by the power supply for the electronics and sensors of the CPX terminal.

The power supply for the outputs and valves is provided by the power supply for the valves of the CPX terminal.

The interlinking block with additional supply ensures a separate supply voltage for the valves and outputs. This means it is possible to disconnect this supply voltage separately.

The valves and outputs of the connected I-Port devices can therefore be dis-

connected separately without disconnecting the devices.

Datasheet – I-Port interface

General technical data			
Type	CPX-CTEL-4-M12-5POL		
Protocol	I-Port		
Maximum address volume	Outputs	[bit]	256
	Inputs	[bit]	256
I-Port connection	4x socket M12, 5-pin, A-coded		
Number of I-Port interfaces	4		
Maximum cable length	[m]		20
Internal cycle time	[ms]		1 per 8 bits of user data
Galvanic isolation	Channel – channel	No	
	Channel – internal bus	Yes, with intermediate air supply	
LED indicators	X1 ... 4 = Status of the I-Port interface 1 ... 4 PS = Electronic supply PL = Load supply ·  = Module error		
Diagnostics	<ul style="list-style-type: none"> • Communication error • Module short circuit • Module-oriented diagnostics • Undervoltage 		
Parameterisation	<ul style="list-style-type: none"> • Diagnostic behaviour • Fail-safe per channel • Forcing per channel • Idle mode per channel • Module parameters • Tool change mode 		
Additional functions	Tool change mode		
Control elements	DIL switches		
Operating voltage	Nominal width	[V DC]	24 (reverse polarity protected)
	Permissible range	[V DC]	18 ... 30
	Power failure buffering	[ms]	10
Intrinsic current consumption at nominal operating voltage	[mA]		Typically 65
Max. power supply per channel	[A]		4x 1.6
Max. residual current of outputs per channel	[A]		4x 1.6
Degree of protection to EN 60529	IP65, IP67		
Temperature range	Operation	[°C]	-5 ... +50
	Storage/transport	[°C]	-20 ... +70
Materials	Reinforced PA, PC		
Note on materials	RoHS-compliant		
LABS (PWIS) conformity	VDMA24364-B2-L		
Grid dimension	[mm]		50
Dimensions (including interlinking block) W x L x H	[mm]		50 x 107 x 55
Product weight	[g]		110

 **Note**

Please observe the general limits and guidelines for the system when configuring the electric modules.

Datasheet – I-Port interface

Connection and display components

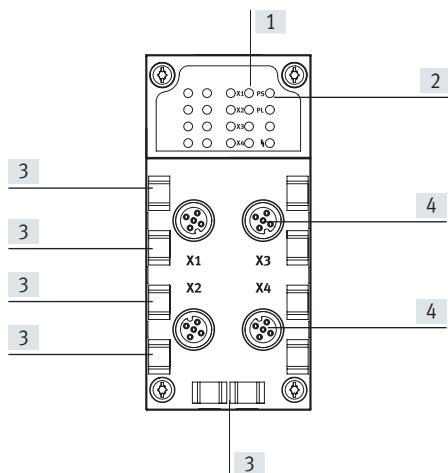

- [1] Status LEDs for I-Port interfaces
- [2] CPX-specific status LEDs
- [3] Holders for inscription labels (IBS 6x10)
- [4] I-Port interfaces for up to 4 devices

Combinations of bus nodes/control blocks with interface CPX-CTEL		
Bus node/control block	Part no.	Interface
		CPX-CTEL-4-M12-5POL
CPX-CEC-C1	567347	■
CPX-CEC-C1-V3	3473128	■
CPX-CEC-M1-V3	3472765	■
CPX-CEC	567346	■
CPX-CEC-S1-V3	3472425	■
CPX-FB11	526172	■
CPX-FB13	195740	■
CPX-FB23-24	526176	■
CPX-FB36	1912451	■
CPX-FB37	2735960	■
CPX-FB39	2093101	■
CPX-FB40	2474896	■
CPX-FB43	8110369	■
CPX-M-FB44	8110370	■
CPX-M-FB45	8110371	■

Pin assignment – I-Port interface			
Terminal assignment	Pin	Signal	Designation
	1	24 V _{SEN}	24 V DC supply voltage for electronics and inputs
	2	24 V _{VAL}	24 V DC load voltage supply for valves and outputs
	3	0 V _{SEN}	0 V DC supply voltage for electronics and sensors
	4	C/Q I-Port	Communication signal C/Q, data transmission line
	5	0 V _{VALVES}	0 V DC load voltage supply for valves and outputs

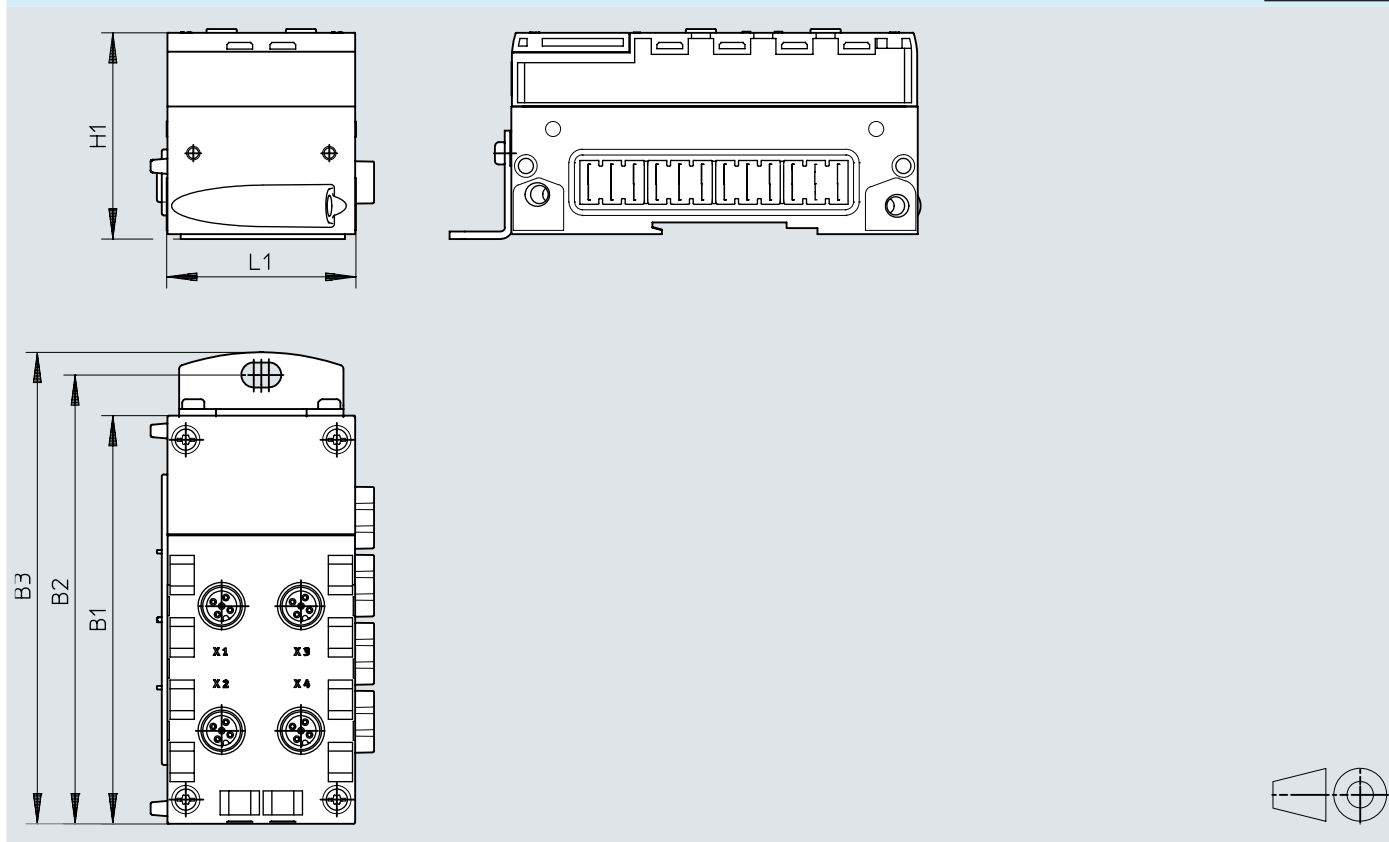

Datasheet – I-Port interface

Dimensions

Download CAD data → www.festo.com

Type	B1	B2	B3	H1	L1
CPX-CTEL-4-M12-5POL	108.1	118.9	124.9	55.1	50

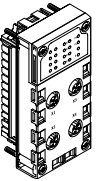
Datasheet – I-Port interface

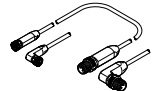
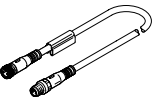
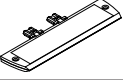
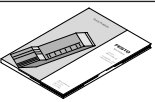
Ordering data			
Designation		Part no.	Type
CPX-CTEL master			
	Interface for a maximum of 4 I/O modules and valve terminals with I-Port interface (devices)		1577012 CPX-CTEL-4-M12-5POL
Bus connection			
	Cover cap	M12	165592 ISK-M12
	Modular system for a choice of connecting cables		– NEBA-... → Internet: neba
	Connecting cable M12-M12, 5-pin • Straight socket • Straight plug	Cable characteristic: suitable for use with energy chains	5 m 574321 NEBU-M12G5-E-5-Q8N-M12G5
			7.5 m 574322 NEBU-M12G5-E-7.5-Q8N-M12G5
			10 m 574323 NEBU-M12G5-E-10-Q8N-M12G5
	Inscription label holder for connection block		536593 CPX-ST-1
User documentation			
	User documentation CPX CTEL master	German	574600 CPX-CTEL-4-M12-5POL-DE
		English	574601 CPX-CTEL-4-M12-5POL-EN

Datasheet – IO-Link® interface

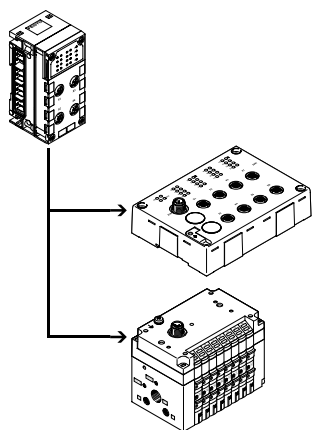

The electrical interface CPX-CTEL-2... enables the connection of modules with IO-Link® interface (IO-Link® device) to the CPX terminal. The I/O data from the connected devices are transmitted to the connected CPX bus node and thus to the higher-order controller via fieldbus. A maximum of two IO-Link devices can be connected to a CPX-CTEL-2... electrical interface via appropriate M12 interfaces.



Application

IO-Link®

The communication system IO-Link® is used to exchange serial data from decentralised function modules (devices) at the field level.

The electrical interface CPX-CTEL-2... provides two external IO-Link® inter-

faces, each of which can be connected to a device.

The connection type corresponds to a star topology, which means that only one device can be connected to each port.

The address space that the module makes available and assigns accordingly in the CPX system can be configured according to various presets. Selecting the operating mode and setting the manual configuration takes place via the DIL switches.

These DIL switches are not required during continuous operation and are only accessible in the disassembled state.

Constraints

The interfaces (ports) of electrical interface CPX-CTEL-2... support the connection of IO-Link® devices with few limitations.

- The process data length of the inputs and outputs is limited to 16 bytes for inputs and 16 bytes for outputs per port
- The driver strength on the C/Q line is limited to 250 mA
- SIO mode is not supported

Power supply for devices

The electrical interface CPX-CTEL-2... provides two separate power supplies for the connected devices:

- For operating the device and the inputs connected to it
- For the outputs and valves that are connected to the device

The power supply for the devices and the inputs is provided by the power

supply for the electronics and sensors of the CPX terminal.

The power supply for the outputs and valves is provided by the power supply for the valves of the CPX terminal.

The interlinking block with additional supply ensures a separate supply voltage for the valves and outputs. This

means it is possible to disconnect this supply voltage separately.

The valves and outputs of the connected I-Port devices can therefore be disconnected separately without disconnecting the devices.

Datasheet – IO-Link® interface

General technical data			
Type	CPX-CTEL-2-M12-5POL-LK		
Protocol	IO-Link®, master version V 1.0		
Maximum address volume	Outputs	[bit]	256
	Inputs	[bit]	256
I-Port connection	2x socket M12, 5-pin, A-coded		
Number of IO-Link® interfaces	2		
Maximum cable length	[m]		20
Internal cycle time	[ms]		1 per 8 bits of user data
Galvanic isolation	Channel – channel	No	
	Channel – internal bus	Yes, with intermediate air supply	
LED indicators	X1 ... 2 = Status of the IO-Link® interface 1 ... 2 PS = Electronic supply PL = Load supply  = Module error		
Diagnostics	<ul style="list-style-type: none"> • Communication error • Module short circuit • Module-oriented diagnostics • Undervoltage 		
Parameterisation	<ul style="list-style-type: none"> • Diagnostic behaviour • Fail-safe per channel • Forcing per channel • Idle mode per channel • Module parameters 		
Additional functions	–		
Control elements	DIL switches		
Operating voltage	Nominal width	[V DC]	24 (reverse polarity protected)
	Permissible range	[V DC]	18 ... 30
	Power failure buffering	[ms]	10
Intrinsic current consumption at nominal operating voltage	[mA]		Typically 65
Max. power supply per channel	[A]		2x 1.6
Max. residual current of outputs per channel	[A]		2x 1.6
Degree of protection to EN 60529	IP65, IP67		
Temperature range	Operation	[°C]	–5 ... +50
	Storage/transport	[°C]	–20 ... +70
Materials	Reinforced PA, PC		
Note on materials	RoHS-compliant		
LABS (PWIS) conformity	VDMA24364-B2-L		
Grid dimension	[mm]		50
Dimensions (including interlinking block) W x L x H	[mm]		50 x 107 x 55
Product weight	[g]		110

 **Note**

Please observe the general limits and guidelines for the system when configuring the electric modules.

Datasheet – IO-Link® interface

Connection and display components

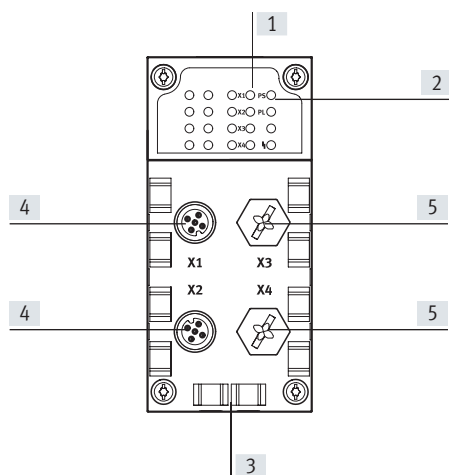

- [1] Status LEDs for I-Port interfaces
- [2] CPX-specific status LEDs
- [3] Holders for inscription labels (IBS 6x10)
- [4] IO-Link® interfaces for up to 2 devices
- [5] Unused connections

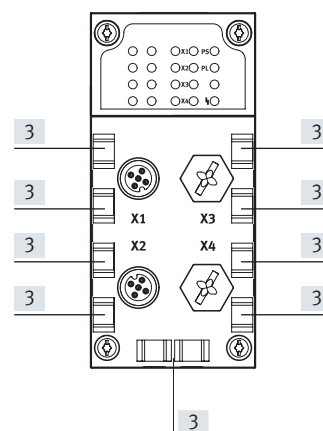

Combinations of bus nodes/control blocks with interface CPX-CTEL-2

Bus node/control block	Part no.	Interface
		CPX-CTEL-2-M12-5POL-LK
CPX-CEC-C1-V3	3473128	■
CPX-CEC-M1-V3	3472765	■
CPX-CEC-S1-V3	3472425	■
CPX-FB36	1912451	■
CPX-FB39	2093101	■
CPX-FB43	8110369	■
CPX-M-FB44	8110370	■
CPX-M-FB45	8110371	■

Pin assignment– IO-Link® interface

Terminal assignment	Pin	Signal	Designation
	1	24 V _{SEN}	24 V DC supply voltage for electronics and inputs
	2	24 V _{VAL}	24 V DC load voltage supply for valves and outputs
	3	0 V _{SEN}	0 V DC supply voltage for electronics and sensors
	4	C/Q _{I-Port}	Communication signal C/Q, data transmission line
	5	0 V _{VALVES}	0 V DC load voltage supply for valves and outputs

Datasheet – IO-Link® interface



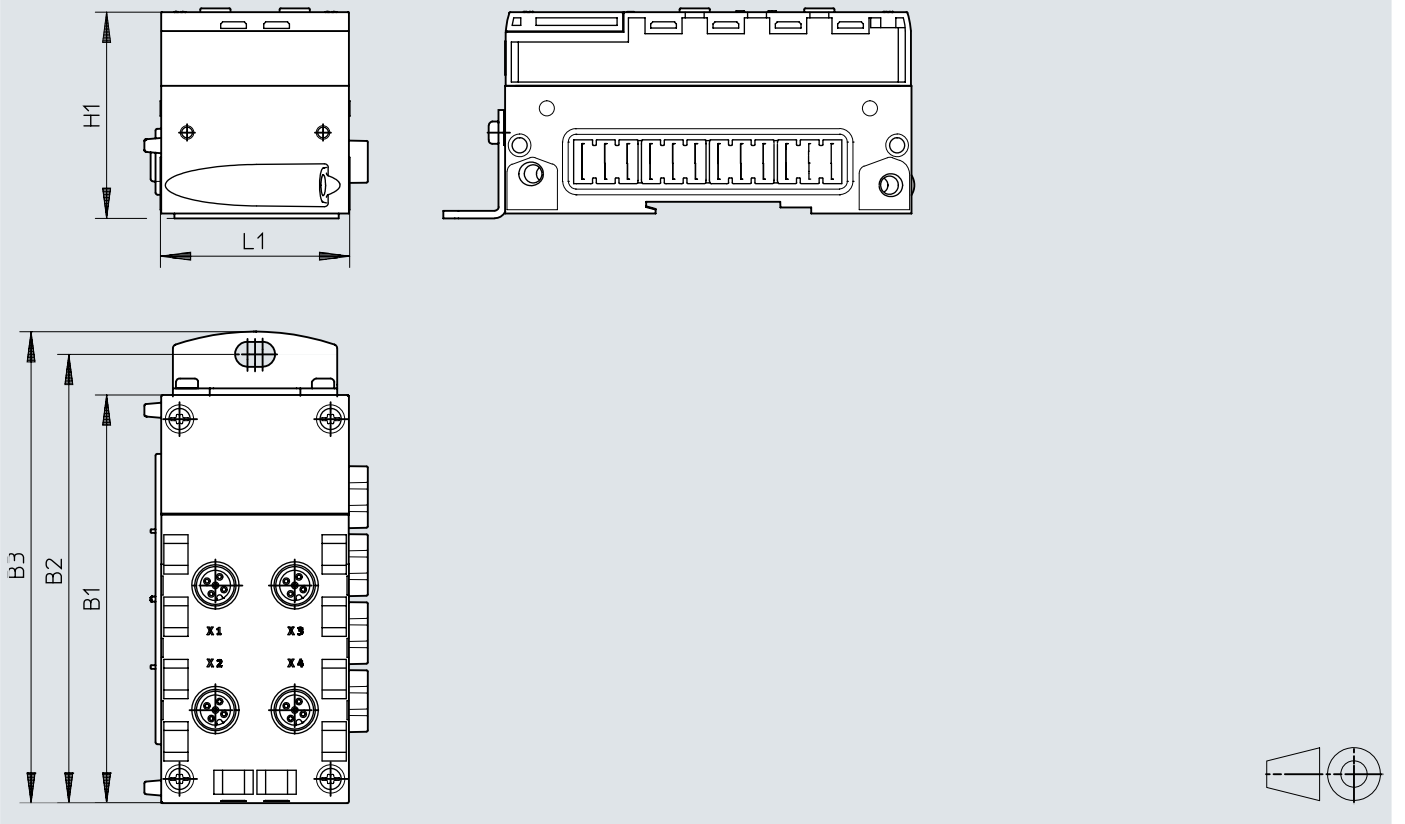

Dimensions

Download CAD data → www.festo.com

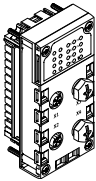

Type	B1	B2	B3	H1	L1
CPX-CTEL-2-M12-5POL-LK	108.1	118.9	124.9	55.1	50

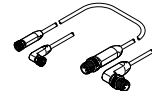
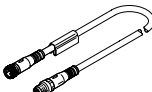
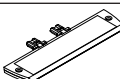
Datasheet – IO-Link® interface

Ordering data				Part no.	Type
Designation					
CPX CTEL master, IO-Link®					
	Interface for max. 2 I/O modules and valve terminals with IO-Link® interface (devices)			2900543	CPX-CTEL-2-M12-5POL-LK
Bus connection					
	Cover cap	M12		165592	ISK-M12
	Modular system for a choice of connecting cables			–	NEBA-... → Internet: neba
	Connecting cable M12-M12, 5-pin • Straight socket • Straight plug	Cable characteristic: suitable for use with energy chains	5 m	574321	NEBU-M12G5-E-5-Q8N-M12G5
			7.5 m	574322	NEBU-M12G5-E-7.5-Q8N-M12G5
			10 m	574323	NEBU-M12G5-E-10-Q8N-M12G5
	Inscription label holder for connection block			536593	CPX-ST-1
User documentation					
	User documentation CPX CTEL master	German		8034115	CPX-CTEL-2-M12-5POLLK-DE
		English		8034116	CPX-CTEL-2-M12-5POLLK-EN

Datasheet – Axis controller for 4 electric axes

The control block CPX-CM-HPP is a module in the CPX terminal for controlling electric drives.

The control component is independent of the bus node used.

This means that Festo's electric drive technology is compatible with all industrial communication interfaces.

The control block does not need to be programmed.

- Max. 4 individual electric axes can be controlled via CAN bus
- No programming required
- Standardised communication with the drives via the Festo Handling and Positioning Profile (FHPP)
- Quick configuration and diagnostics via CPX-FMT
- Simple, flexible and cost-effective programmed.



General technical data		
Fieldbus interface		1x socket M9, 5-pin
Protocol		FHPP
Max. address volume inputs	[byte]	32
Max. address volume for outputs	[byte]	32
LED indicator (product-specific)		Error: Fault PL: Load supply
Device-specific diagnostics		Diagnostics memory Channel and module-oriented diagnostics Undervoltage/short circuit of modules
Parameterisation		Forcing of channels System parameters
Configuration support		Operator unit CPX-MMI
Total number of axes		4
Nominal operating voltage	[V DC]	24
Operating voltage range	[V DC]	18 ... 30
Power failure buffering	[ms]	10
Intrinsic current consumption at nominal operating voltage	[mA]	Typ. 80
Degree of protection to EN 60529 (with plug inserted)		IP65/IP67
Dimensions W x L x H (including interlinking block)	[mm]	50 x 107 x 55
Product weight (without interlinking block)	[g]	140
Materials		
Housing		Reinforced PA PC
Note on materials		RoHS-compliant
LABS (PWIS) conformity		VDMA24364-B2-L

Technical data – Interfaces		
Interface		
Control interface		CAN bus
Baud rate	[Mbps]	1

Operating and environmental conditions		
Ambient temperature	[°C]	-5 ... +50
Storage temperature	[°C]	-20 ... +70
CE marking (see declaration of conformity)		To EU Low Voltage Directive

Datasheet – Axis controller for 4 electric axes

Connection and display components

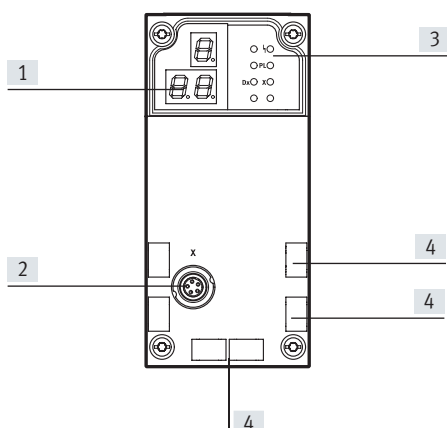

- [1] 3-digit display
- [2] Control interface
- [3] LED indicator (product-specific)
- [4] Inscription labels



Pin assignment – Control interface

	Pin	Signal	Meaning
Socket M9, 5-pin			
	1	n.c.	Not connected
	2	n.c.	Not connected
	3	CAN_GND	CAN Ground
	4	CAN_H	CAN High
	5	CAN_L	CAN low
	Housing	Shielding	Cable shield must be connected to functional earth (FE)

Permitted bus nodes/CEC

Bus node/CEC	Protocol	Max. number of CPX-CM-HPP modules
CPX-CEC...	–	0
CPX-FB11	DeviceNet®	2
CPX-FB13	PROFIBUS	2
CPX-FB23-24	CC-LINK®	1 (as function module F23)
		0 (as function module F24)
CPX-FB36	EtherNet/IP	2
CPX-FB37	EtherCAT®	2
CPX-FB39	Sercos III	2
CPX-FB40	POWERLINK	2
CPX-FB43	PROFINET RT, M12	2
CPX-M-FB44	PROFINET RT, RJ45	2
CPX-M-FB45	PROFINET RT, SCRJ	2

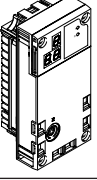
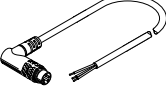
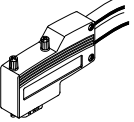
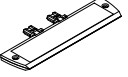
Datasheet – Axis controller for 4 electric axes

Ordering data – Bus connection			
Designation		Part no.	Type
Control block			
	For controlling up to 4 electric drives via CAN bus	562214	CPX-CM-HPP
Connecting cable			
	Connecting cable	2 m	563711 NEBC-M9W5-K-2-N-LE3
		5 m	563712 NEBC-M9W5-K-5-N-LE3
	Plug for CAN bus interface; Sub-D, 9-pin, without terminating resistor	533783	FBS-SUB-9-WS-CO-K
Inscription labels			
	Inscription label holder for connection block	536593	CPX-ST-1
User documentation			
	Description control block CPX-CM-HPP	German	568683 CPX-CM-HPP-DE
		English	568684 CPX-CM-HPP-EN

Datasheet – Axis controller for 1 electric axis

The axis controller CPX-CMAX is intended exclusively for use in valve terminals CPX.



General technical data			
Operating voltage			
Operating voltage range	[V DC]	18 ... 30	
Nominal operating voltage	[V DC]	24	
Current consumption at nominal operating voltage	[mA]	200	
Fuse protection (short circuit)		Electronic	
Power failure buffering	[ms]	10	
Load voltage			
Load voltage range	[V DC]	20 ... 30	
Nominal load voltage	[V DC]	24	
Permissible load current	[A]	2.5	
Fuse protection (short circuit)		Electronic	
No. of axis strings		1	
Axes per string		1	
Length of connecting cable to axis	[m]	≤ 30	
Max. number of modules		7	
Display		7-segment display	
Assigned addresses	Outputs	[bit]	8x8
	Inputs	[bit]	8x8
Operating modes		Record mode	
		Direct mode	
Controller types		Position control	
		Force control	
Diagnostics		Module-orientated	
		Via local 7-segment display	
Status indicator		Module status	
		Power load	
		Display/Error Axis X	
		MC Axis X	
Control interface			
Data		CAN bus with Festo protocol	
		Digital	
Electrical connection		5-pin	
		M9	
		Socket	
Materials: Housing		Reinforced PA	
Note on materials		RoHS-compliant	
LABS (PWIS) conformity		VDMA24364-B2-L	
Product weight	[g]	240	
Dimensions	Length	[mm]	107
	Width	[mm]	50
	Height	[mm]	55

Datasheet – Axis controller for 1 electric axis

Operating and environmental conditions

Ambient temperature	[°C]	-5 ... +50
Relative humidity	[%]	5 ... 95, non-condensing
Degree of protection to IEC 60529		IP65

Connection and display components

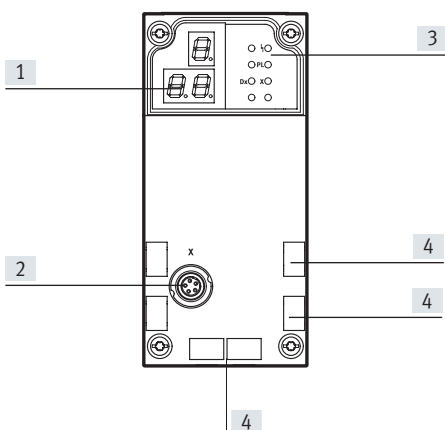

- [1] 3-digit display
- [2] Control interface
- [3] Status LEDs
- [4] Inscription labels

Pin assignment – Control interface





	Pin	Signal	Designation
	1	+24 V	Nominal operating voltage
	2	+24 V	Load voltage
	3	0 V	Ground
	4	CAN_H	CAN High
	5	CAN_L	CAN low
	Housing	Shielding	Cable shield

Permitted bus nodes/CEC

Bus node/CEC	Protocol	Max. number of CMAX modules
CPX-CEC...	–	8
CPX-FB11	DeviceNet ¹⁾	8
CPX-FB13	PROFIBUS ²⁾	8
CPX-FB23-24	CC-LINK [®]	4 (as function module F23)
		8 (as function module F24)
CPX-FB36	EtherNet/IP	8
CPX-FB37	EtherCAT [®]	8
CPX-FB39	Sercos III	8
CPX-FB40	POWERLINK	8
CPX-FB43	PROFINET RT, M12	8
CPX-M-FB44	PROFINET RT, RJ45	8
CPX-M-FB45	PROFINET RT, SCRJ	8

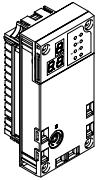
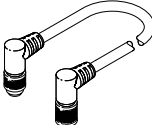
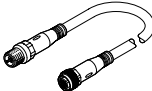
1) As of revision 20 (R20)
 2) As of revision 23 (R23)

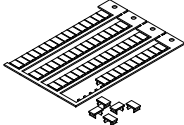
Datasheet – Axis controller for 1 electric axis

Ordering data		Brief description	Part no.	Type
Axis controller				
	Order code in CPX configurator: T21		548932	CPX-CMAX-C1-1
Connecting cables				
	Connecting cable with angled plug and angled socket	0.25 m	540327	KVI-CP-3-WS-WD-0.25
		0.5 m	540328	KVI-CP-3-WS-WD-0.5
		2 m	540329	KVI-CP-3-WS-WD-2
		5 m	540330	KVI-CP-3-WS-WD-5
		8 m	540331	KVI-CP-3-WS-WD-8
	Connecting cable with straight plug and straight socket	2 m	540332	KVI-CP-3-GS-GD-2
		5 m	540333	KVI-CP-3-GS-GD-5
		8 m	540334	KVI-CP-3-GS-GD-8
	Connecting component for cabinet through feed		543252	KVI-CP-3-SSD
Screws				
	For mounting on the metal interlinking block		550219	CPX-M-M3X22-4X
Inscription labels				
	Inscription labels 6x10, in frames	Pack of 64	18576	IBS-6X10
User documentation				
	Description axis controller CPX-CMAX1)	German	559750	CPX-CMAX-C1-1-DE
		English	559751	CPX-CMAX-C1-1-EN
		German	559756	CPX-CMAX-C1-1-DE
		English	559757	CPX-CMAX-C1-1-EN

1) User documentation in paper form is not included in the scope of delivery.

Datasheet – End-position controller

The end-position controller CPX-CMPX is intended exclusively for use in valve terminals CPX.

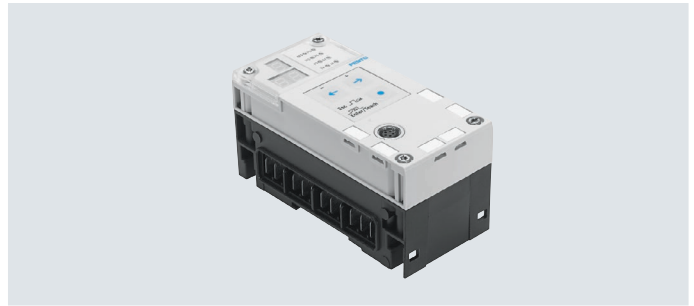

General technical data

Operating voltage

Operating voltage range	[V DC]	18 ... 30
Nominal operating voltage	[V DC]	24
Current consumption at nominal operating voltage	[mA]	80

Load voltage

Load voltage range	[V DC]	20 ... 30
Nominal load voltage	[V DC]	24
Permissible load current	[A]	2.5

Number of axes per module		1	
Length of connecting cable to axis	[m]	≤ 30	
Max. number of modules		9	
Display		7-segment display	
Control elements		3 keys	
Assigned addresses	Outputs	[bit]	6x8
	Inputs	[bit]	6x8
Diagnostics			Module-orientated
			Via local 7-segment display
Status indicator			Module status
			Power load

Control interface

Data		CAN bus with Festo protocol
		Digital
Electrical connection		5-pin
		M9
		Socket

Materials: Housing		Reinforced PA	
LABS (PWIS) conformity		VDMA24364-B2-L	
Product weight	[g]	140	
Dimensions	Length	[mm]	107
	Width	[mm]	50
	Height	[mm]	55

Datasheet – End-position controller

Operating and environmental conditions

Ambient temperature	[°C]	–5 ... +50
Relative humidity	[%]	5 ... 95, non-condensing
Degree of protection to IEC 60529		IP65

Connection and display components

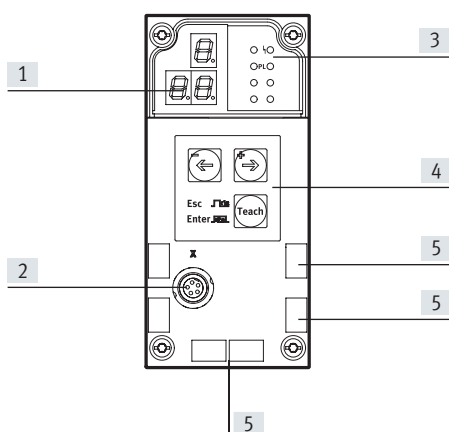

- [1] 3-digit display
- [2] Control interface
- [3] Status LEDs
- [4] Operating buttons
- [5] Inscription labels

Pin assignment – Control interface

	Pin	Signal	Designation
	1	+24 V	Nominal operating voltage
	2	+24 V	Load voltage
	3	0 V	Ground
	4	CAN_H	CAN High
	5	CAN_L	CAN low
	Housing	Shielding	Cable shield





Permitted bus nodes/CEC

Bus node/CEC	Protocol	Max. number of CMPX modules
CPX-CEC...	–	9
CPX-FB11	DeviceNet ¹⁾	9
CPX-FB13	PROFIBUS ²⁾	9
CPX-FB23-24	CC-LINK [®]	5 (as function module F23)
		9 (as function module F24)
CPX-FB36	EtherNet/IP	9
CPX-FB37	EtherCAT [®]	9
CPX-FB39	Sercos III	9
CPX-FB40	POWERLINK	9
CPX-FB43	PROFINET RT, M12	9
CPX-M-FB44	PROFINET RT, RJ45	9
CPX-M-FB45	PROFINET RT, SCRJ	9

1) As of revision 20 (R20)

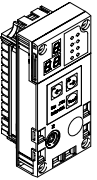
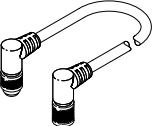
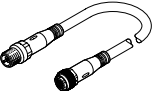
2) As of revision 23 (R23)

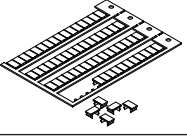
Datasheet – End-position controller

Ordering data		Brief description	Part no.	Type
End-position controller				
	Order code in CPX configurator: T20		548931	CPX-CMPX-C-1-H1
Connecting cables				
	Connecting cable with angled plug and angled socket	0.25 m	540327	KVI-CP-3-WS-WD-0.25
		0.5 m	540328	KVI-CP-3-WS-WD-0.5
		2 m	540329	KVI-CP-3-WS-WD-2
		5 m	540330	KVI-CP-3-WS-WD-5
		8 m	540331	KVI-CP-3-WS-WD-8
	Connecting cable with straight plug and straight socket	2 m	540332	KVI-CP-3-GS-GD-2
		5 m	540333	KVI-CP-3-GS-GD-5
		8 m	540334	KVI-CP-3-GS-GD-8
	Connecting component for cabinet through feed		543252	KVI-CP-3-SSD
Screws				
	For mounting on the metal interlinking block		550219	CPX-M-M3X22-4X
Inscription labels				
	Inscription labels 6x10, in frames	Pack of 64	18576	IBS-6X10
User documentation				
	Description end-position controller CPX-CMPX1)	German	555479	CPX-CMPX-C-1-H1-DE
		English	555480	CPX-CMPX-C-1-H1-EN

1) User documentation in paper form is not included in the scope of delivery.

Datasheet – Measuring module for displacement encoder

The measuring module CPX-CMIX is intended exclusively for use in valve terminals CPX.



General technical data

Operating voltage			
Operating voltage range	[V DC]		18 ... 30
Nominal operating voltage	[V DC]		24
Current consumption at nominal operating voltage	[mA]		80
Short circuit current rating			Yes
Power failure buffering	[ms]		10
No. of axis strings			1
Axes per string			1
Length of connecting cable to axis	[m]		≤ 30
Max. number of modules			9
Display			7-segment display
Assigned addresses	Outputs	[bit]	6x8
	Inputs	[bit]	6x8
Diagnostics			Channel- and module-orientated
			Via local 7-segment display
			Undervoltage of modules
			Undervoltage of measuring system
Status indicator			Power load
			Error
Control interface			
Data			CAN bus with Festo protocol
			Digital
Electrical connection			5-pin
			M9
			Socket
Materials: Housing			Reinforced PA
Note on materials			RoHS-compliant
LABS (PWIS) conformity			VDMA24364-B2-L
Product weight	[g]		140
Dimensions	Length	[mm]	107
	Width	[mm]	50
	Height	[mm]	55

Datasheet – Measuring module for displacement encoder

Operating and environmental conditions

Ambient temperature	[°C]	-5 ... +50
Storage temperature	[°C]	-20 ... +70
Relative humidity	[%]	5 ... 95, non-condensing
Degree of protection to IEC 60529		IP65

Connection and display components

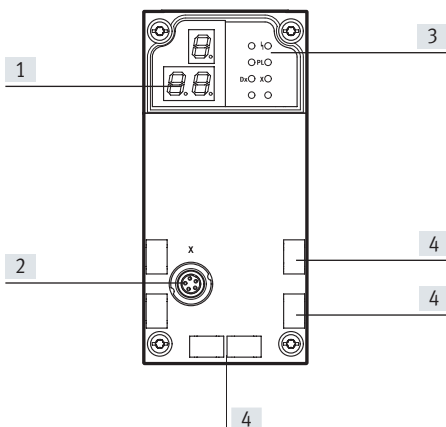

- [1] 3-digit display
- [2] Control interface
- [3] Status LEDs
- [4] Inscription labels

Pin assignment – Control interface

	Pin	Signal	Designation
	1	+24 V	Nominal operating voltage
	2	+24 V	Load voltage
	3	0 V	Ground
	4	CAN_H	CAN High
	5	CAN_L	CAN low
	Housing	Shielding	Cable shield



Permitted bus nodes/CEC

Bus node/CEC	Protocol	Max. number of CMIX modules
CPX-CEC...	–	9
CPX-FB11	DeviceNet ¹⁾	9
CPX-FB13	PROFIBUS ²⁾	9
CPX-FB23-24	CC-LINK®	5 (as function module F23)
		9 (as function module F24)
CPX-FB36	EtherNet/IP	9
CPX-FB37	EtherCAT®	9
CPX-FB39	Sercos III	9
CPX-FB40	POWERLINK	9
CPX-FB43	PROFINET RT, M12	9
CPX-M-FB44	PROFINET RT, RJ45	9
CPX-M-FB45	PROFINET RT, SCRJ	9

1) As of revision 20 (R20)

2) As of revision 23 (R23)

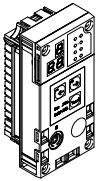
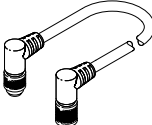
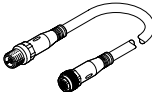
Datasheet – Measuring module for displacement encoder

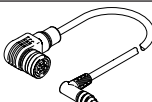
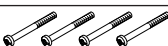
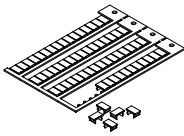
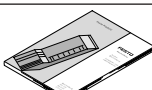
Ordering data		Brief description	Part no.	Type
Measuring module				
	Order code in the CPX configurator: T23		567417	CPX-CMIX-M1-1
Connecting cables				
	Connecting cable with angled plug and angled socket	0.25 m	540327	KVI-CP-3-WS-WD-0.25
		0.5 m	540328	KVI-CP-3-WS-WD-0.5
		2 m	540329	KVI-CP-3-WS-WD-2
		5 m	540330	KVI-CP-3-WS-WD-5
		8 m	540331	KVI-CP-3-WS-WD-8
	Connecting cable with straight plug and straight socket	2 m	540332	KVI-CP-3-GS-GD-2
		5 m	540333	KVI-CP-3-GS-GD-5
		8 m	540334	KVI-CP-3-GS-GD-8
	Connecting component for cabinet through feed		543252	KVI-CP-3-SSD
	For displacement encoder MME: Connection between displacement encoder MME and measuring module CPX-CMIX	2 m	575898	NEBP-M16W6-K-2-M9W5
Screws				
	For mounting on the metal interlinking block		550219	CPX-M-M3X22-4X
Inscription labels				
	Inscription labels 6x10, in frames	Pack of 64	18576	IBS-6X10
User documentation				
	Description measuring module CPX-CMIX1)	German	567053	CPX-CMIX-M1-1-DE
		English	567054	CPX-CMIX-M1-1-EN

1) User documentation in paper form is not included in the scope of delivery.

Datasheet – Input module, digital

Function

Digital input modules enable the connection of two-wire and three-wire sensors (proximity switches, inductive or capacitive sensors, etc.). Depending on the connection block selected, the module supports various connection concepts with different numbers of sockets (single or double allocation).

Area of application

- Input modules for 24 V DC sensor supply voltage
- PNP or NPN logic
- Supports connection blocks with M12, M8, Sub-D and terminal connection
- Module features can be parameterised
- The input module receives the voltage supply for the electronics and the sensors from the interlinking block
- Module protection and diagnostics through integrated electronic fuse

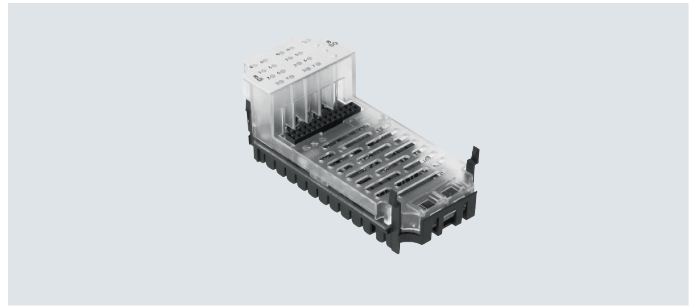

General technical data		CPX-4DE	CPX-8DE	CPX-8DE-D	CPX-8NDE
Type					
Number of inputs		4	8	8	8
Max. total current of inputs per module	[A]	0.7	1	0.7	0.7
Fuse protection		Internal electronic fuse per module	Internal electronic fuse per module	Internal electronic fuse per channel	Internal electronic fuse per module
Intrinsic current consumption at operating voltage	[mA]	Typ. 15			
Operating voltage	Nominal width	24			
	Permissible range	18 ... 30			
Galvanic isolation	Channel – channel	No			
	Channel – internal bus	No			
Switching level	Signal 0	[V DC]	≤ 5		≥ 11
	Signal 1	[V DC]	≥ 11		≤ 5
Input debounce time	[ms]	3 (0.1, 10, 20 parameterisable)			
Input characteristic		IEC 1131-T2			
Switching logic		Positive logic (PNP)			Negative logic (NPN)
LED indicators	Group diagnostics	1	1	1	1
	Channel diagnostics	–	–	8	–
	Channel status	4	8	8	8
Diagnostics		Short circuit/overload per channel			
Parameterisation		<ul style="list-style-type: none"> • Module monitoring • Behaviour after short circuit • Input debounce time • Signal extension time 			
Degree of protection to EN 60529		Depending on connection block			
Temperature range	Operation	[°C]	–5 ... +50		
	Storage/transport	[°C]	–20 ... +70		
Materials		Reinforced PA, PC			
LABS (PWIS) conformity		VDMA24364-B2-L			
Grid dimension	[mm]	50			
Dimensions (including interlinking block and connection block) W x L x H	[mm]	50 x 107 x 50			
Product weight	[g]	39	39	45	40

Datasheet – Input module, digital

Connection and display components

CPX-4DE

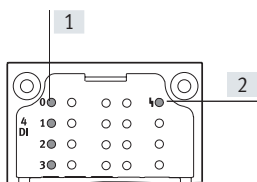

CPX-8DE

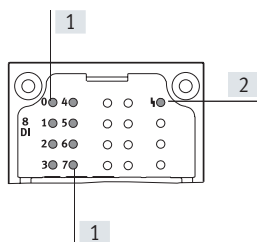

CPX-8DE-D

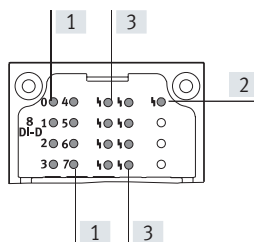

CPX-8NDE

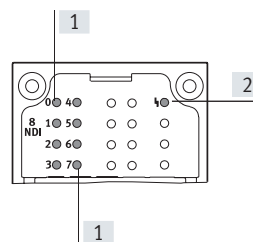

[1] Status LEDs (green)

[2] Error LED (red; module error)

[3] Channel-related error LEDs (red)

For assigning to inputs
→ Pin assignment of the module

Combinations of connection blocks and digital input modules

Connection blocks	Part no.	Digital input modules			
		CPX-4DE	CPX-8DE	CPX-8DE-D	CPX-8NDE
CPX-AB-8-M8-3POL	195706	■	■	■	■
CPX-AB-4-M12X2-5POL	195704	■	■	■	■
CPX-AB-4-M12X2-5POL-R	541254	■	■	■	■
CPX-AB-8-KL-4POL	195708	■	■	■	■
CPX-AB-1-SUB-BU-25POL	525676	■	■	■	■
CPX-M-AB-4-M12X2-5POL	549367	■	■	■	■

Pin assignment



Connection block inputs	CPX-4DE	CPX-8DE, CPX-8DE-D and CPX-8NDE		
CPX-AB-8-M8-3POL				
	X1.1: 24 V _{SEN} X1.3: 0 V _{SEN} X1.4: Input x X2.1: 24 V _{SEN} X2.3: 0 V _{SEN} X2.4: Input x+1 X3.1: 24 V _{SEN} X3.3: 0 V _{SEN} X3.4: Input x+1 X4.1: 24 V _{SEN} X4.3: 0 V _{SEN} X4.4: n.c.	X5.1: 24 V _{SEN} X5.3: 0 V _{SEN} X5.4: Input x+2 X6.1: 24 V _{SEN} X6.3: 0 V _{SEN} X6.4: Input x+3 X7.1: 24 V _{SEN} X7.3: 0 V _{SEN} X7.4: Input x+3 X8.1: 24 V _{SEN} X8.3: 0 V _{SEN} X8.4: n.c.	X1.1: 24 V _{SEN x} X1.3: 0 V _{SEN x} X1.4: Input x X2.1: 24 V _{SEN x+1} X2.3: 0 V _{SEN x+1} X2.4: Input x+1 X3.1: 24 V _{SEN x+2} X3.3: 0 V _{SEN x+2} X3.4: Input x+2 X4.1: 24 V _{SEN x+3} X4.3: 0 V _{SEN x+3} X4.4: Input x+3	X5.1: 24 V _{SEN x+4} X5.3: 0 V _{SEN x+4} X5.4: Input x+4 X6.1: 24 V _{SEN x+5} X6.3: 0 V _{SEN x+5} X6.4: Input x+5 X7.1: 24 V _{SEN x+6} X7.3: 0 V _{SEN x+6} X7.4: Input x+6 X8.1: 24 V _{SEN x+7} X8.3: 0 V _{SEN x+7} X8.4: Input x+7
CPX-AB-4-M12X2-5POL, CPX-AB-4-M12X2-5POL-R¹⁾ and CPX-M-AB-4-M12X2-5POL				
	X1.1: 24 V _{SEN} X1.2: Input x+1 X1.3: 0 V _{SEN} X1.4: Input x X1.5: FE X2.1: 24 V _{SEN} X2.2: n.c. X2.3: 0 V _{SEN} X2.4: Input x+1 X2.5: FE	X3.1: 24 V _{SEN} X3.2: Input x+3 X3.3: 0 V _{SEN} X3.4: Input x+2 X3.5: FE X4.1: 24 V _{SEN} X4.2: n.c. X4.3: 0 V _{SEN} X4.4: Input x+3 X4.5: FE	X1.1: 24 V _{SEN x} X1.2: Input x+1 X1.3: 0 V _{SEN x} X1.4: Input x X1.5: FE X2.1: 24 V _{SEN x+2} X2.2: Input x+3 X2.3: 0 V _{SEN x+2} X2.4: Input x+2 X2.5: FE	X3.1: 24 V _{SEN x+4} X3.2: Input x+5 X3.3: 0 V _{SEN x+4} X3.4: Input x+4 X3.5: FE X4.1: 24 V _{SEN x+6} X4.2: Input x+7 X4.3: 0 V _{SEN x+6} X4.4: Input x+6 X4.5: FE

1) Speedcon quick lock, additional shielding on metal thread

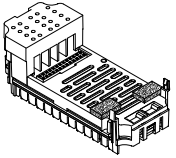
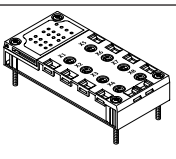
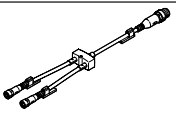

Datasheet – Input module, digital

Pin assignment		CPX-4DE		CPX-8DE, CPX-8DE-D and CPX-8NDE	
CPX-AB-8-KL-4POL					
	X1.0: $24 V_{SEN}$	X5.0: $24 V_{SEN}$	X1.0: $24 V_{SEN x}$	X5.0: $24 V_{SEN x+4}$	
	X1.1: $0 V_{SEN}$	X5.1: $0 V_{SEN}$	X1.1: $0 V_{SEN x}$	X5.1: $0 V_{SEN x+4}$	
	X1.2: Input x	X5.2: Input x+2	X1.2: Input x	X5.2: Input x+4	
	X1.3: FE	X5.3: FE	X1.3: FE	X5.3: FE	
	X2.0: $24 V_{SEN}$	X6.0: $24 V_{SEN}$	X2.0: $24 V_{SEN x+1}$	X6.0: $24 V_{SEN x+5}$	
	X2.1: $0 V_{SEN}$	X6.1: $0 V_{SEN}$	X2.1: $0 V_{SEN x+1}$	X6.1: $0 V_{SEN x+5}$	
	X2.2: Input x+1	X6.2: Input x+3	X2.2: Input x+1	X6.2: Input x+5	
	X2.3: FE	X6.3: FE	X2.3: FE	X6.3: FE	
	X3.0: $24 V_{SEN}$	X7.0: $24 V_{SEN}$	X3.0: $24 V_{SEN x+2}$	X7.0: $24 V_{SEN x+6}$	
	X3.1: $0 V_{SEN}$	X7.1: $0 V_{SEN}$	X3.1: $0 V_{SEN x+2}$	X7.1: $0 V_{SEN x+6}$	
	X3.2: Input x+1	X7.2: Input x+3	X3.2: Input x+2	X7.2: Input x+6	
	X3.3: FE	X7.3: FE	X3.3: FE	X7.3: FE	
	X4.0: $24 V_{SEN}$	X8.0: $24 V_{SEN}$	X4.0: $24 V_{SEN x+3}$	X8.0: $24 V_{SEN x+7}$	
	X4.1: $0 V_{SEN}$	X8.1: $0 V_{SEN}$	X4.1: $0 V_{SEN x+3}$	X8.1: $0 V_{SEN x+7}$	
	X4.2: n.c.	X8.2: n.c.	X4.2: Input x+3	X8.2: Input x+7	
	X4.3: FE	X8.3: FE	X4.3: FE	X8.3: FE	
CPX-AB-1-SUB-BU-25POL					
	1: Input x	14: Input x+2	1: Input x	14: Input x+4	
	2: Input x+1	15: Input x+3	2: Input x+1	15: Input x+5	
	3: Input x+1	16: Input x+3	3: Input x+2	16: Input x+6	
	4: n.c.	17: n.c.	4: Input x+3	17: Input x+7	
	5: $24 V_{SEN}$	18: $24 V_{SEN}$	5: $24 V_{SEN x+1}$	18: $24 V_{SEN x+4}$	
	6: $0 V_{SEN}$	19: $24 V_{SEN}$	6: $0 V_{SEN x+1}$	19: $24 V_{SEN x+5}$	
	7: $24 V_{SEN}$	20: $24 V_{SEN}$	7: $24 V_{SEN x+3}$	20: $24 V_{SEN x+6}$	
	8: $0 V_{SEN}$	21: $24 V_{SEN}$	8: $0 V_{SEN x+3}$	21: $24 V_{SEN x+7}$	
	9: $24 V_{SEN}$	22: $0 V_{SEN}$	9: $24 V_{SEN x}$	22: $0 V_{SEN x+2 u. 3}$	
	10: $24 V_{SEN}$	23: $0 V_{SEN}$	10: $24 V_{SEN x+2}$	23: $0 V_{SEN x+2 u. 3}$	
	11: $0 V_{SEN}$	24: $0 V_{SEN}$	11: $0 V_{SEN x}$	24: $0 V_{SEN x+2 u. 3}$	
	12: $0 V_{SEN}$	25: FE	12: $0 V_{SEN x+2}$	25: FE	
	13: FE	Housing: FE	13: FE	Housing: FE	

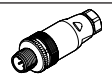
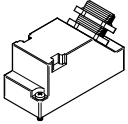
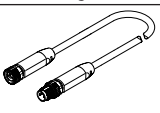
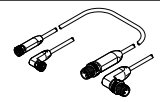
Datasheet – Input module, digital

Ordering data					
Designation		Part no.	Type		
Input module, digital					
	4 digital inputs, positive logic (PNP)	195752	CPX-4DE		
	8 digital inputs, positive logic (PNP)	195750	CPX-8DE		
	8 digital inputs, positive logic (PNP), enhanced diagnostic function	541480	CPX-8DE-D		
	8 digital inputs, negative logic (NPN)	543813	CPX-8NDE		
Connection block					
	Polymer	8x socket M8, 3-pin	195706	CPX-AB-8-M8-3POL	
		4x socket M12, 5-pin	195704	CPX-AB-4-M12X2-5POL	
		4x socket, M12 with quick-lock technology, 5-pin	541254	CPX-AB-4-M12X2-5POL-R	
		Spring-loaded terminal, 32-pin	195708	CPX-AB-8-KL-4POL	
		1x socket, Sub-D, 25-pin	525676	CPX-AB-1-SUB-BU-25POL	
	Metal	4x socket M12, 5-pin	549367	CPX-M-AB-4-M12X2-5POL	
Distributor					
	Modular system for all types of sensor/actuator distributor		–	NEDY-... → Internet: nedy	
	1x plug M12, 4-pin	2x socket M8, 3-pin	8005311	NEDY-L2R1-V1-M8G3-N-M12G4	
		2x socket M12, 5-pin	8005310	NEDY-L2R1-V1-M12G5-N-M12G4	
Plug					
	M8, 3-pin	Screw terminal	8162298	NECB-S-M8G3-C2	
	M12, 4-pin	For cable Ø 2.1 ... 7 mm	8162294	NECB-S-M12G4-C2	
		For 2x cable Ø 2.1 ... 5.6 mm	8162295	NECB-S-M12G4-C2-D	
	M12, 5-pin	For cable Ø 2.1 ... 7 mm	8162296	NECB-S-M12G5-C2	
		For 2x cable Ø 2.1 ... 5.6 mm	8162297	NECB-S-M12G5-C2-D	
	Sub-D plug, 25-pin		527522	SD-SUB-D-ST25	
Connecting cable					
	1x socket M8, 3-pin	1x plug M8, 3-pin	0.5 m	★ 8078282	NEBA-M8G3-U-0.5-N-M8G3
			1.0 m	★ 8078283	NEBA-M8G3-U-1-N-M8G3
			2.5 m	★ 8078286	NEBA-M8G3-U-2.5-N-M8G3
			5.0 m	★ 8078287	NEBA-M8G3-U-5-N-M8G3
	Modular system for a choice of connecting cables		–	NEBA-... → Internet: neba	

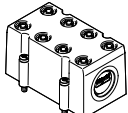
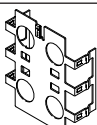
Datasheet – Input module, digital

Ordering data		Part no.	Type
Designation			
Covering			
	Covering hood for CPX-AB-8-KL-4POL (IP65, IP67) • 8 cable through-feeds M9 • 1 cable through-feed for multi-pin plug	538219	AK-8KL
	Fittings kit	538220	VG-K-M9
Screening plate			
	Screening plate for M12 connections	526184	CPX-AB-S-4-M12
User documentation			
	User documentation	German	526439 CPX_DE_DA/CPX_DE-DE
		English	526440 CPX_DE_DA/CPX_DE-EN

Datasheet – Input module, digital, PROFI-safe

Function

The PROFI-safe input module has 8 input channels whose signal status is detected for safety reasons, with the information transmitted to a suitable safety controller using the PROFI-safe safety protocol in combination with the appropriate fieldbus (PROFINET or PROFIBUS). This function is exclusively available for safety controllers using the PROFI-safe protocol, profile version 2.4.

Area of application

- Input module for 24 V DC sensor supply voltage
- Supports connection blocks with M12 and terminal connection
- Module features can be parameterised
- The input module receives the voltage supply for the electronics and the sensors from the interlinking block
- Module protection and diagnostics through integrated electronic fuse

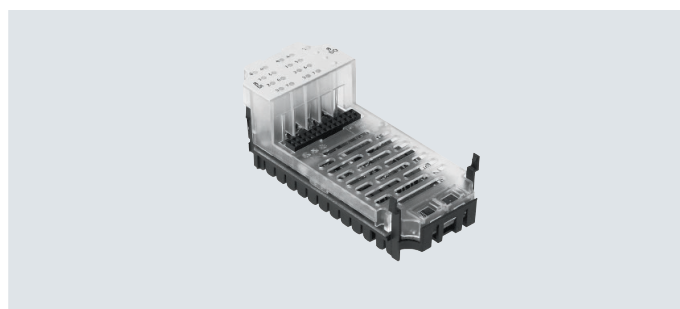

Description

Module-based passivation

While channel-based passivation is disabled, the input module, in accordance with PROFI-safe specification, switches all information in the input image to the safe status, even when there is only one channel error.

Channel-based passivation

In the case of channel-based passivation, when a channel error occurs, the input module switches the input information of the affected channel pair to 0, depending on the function mode.

- The input information for unaffected channel pairs does not change
- The input module remains integrated.
- The input module indicates the current channel error status to the control unit via the input image.

Possible applications

The inputs on the PROFI-safe input module can be combined for multi-channel sensor applications. Every two inputs form a channel pair, which is set separately with one of 11 function modes.

The function mode has an influence on the evaluation of the input signals, and optionally on the generation of clock signals.

There are 5 independent clock outputs available for safe operation of passive sensors; the pulse patterns are used in some operating modes to detect cross-overs in the signal paths.

The entire input module is designed to ensure that the input channels provide either secure data or no data at all, even when an error is present in the system

Application areas

- Use as an input module for a higher-order safety controller. Several input modules can be used together and these monitor mutually independent sensors
- Use of multi-channel sensor applications with up to 8 secure inputs, which can be grouped and are suitable for configuration with the help of 11 different function modes
- Connection of various switches and sensors within the safety chain
- Output of an identifier coded by DIL switch in the connection block CPX-AB-ID-P

Note
The safety integrity level, Performance Level and category for the system as a whole correspond to that of the component in the safety chain with the lowest characteristic value.

Application examples

- Two-hand control device for starting a function
- Emergency stop switch for incidents
- Operating mode selector switch with four positions
- Rotary indexing table
- Light curtain
- Acknowledge button with request
- End-position switch
- Safety door with two N/O switches

Datasheet – Input module, digital, PROFIsafe

General technical data			
Type	CPX-F8DE-P		
Number of inputs	8		
Safety function	Reliable detection and evaluation of input statuses		
Maximum address volume	Inputs	[byte]	6
	Outputs	[byte]	7
Maximum cable length			[m] 200
Max. power supply	Per module	[A]	3
Current consumption of the module			[mA] Typ. 35 (power supply for electronics)
Operating voltage	Nominal width	[V DC]	24
	Permissible range	[V DC]	20.4 ... 28.8
Voltage drop per channel			[V] 0.6
Residual ripple			[Vss] 2 within voltage range
Galvanic isolation	Channel – channel	No	
Input characteristics	To IEC 61131-2, type 2		
Switching logic	Inputs	PNP (positive switching)	
Safety Integrity Level	As per EN 62061	Reliable detection and evaluation of input statuses up to SIL CL3	
	As per EN 61508	Reliable detection and evaluation of input statuses up to SIL3	
Performance Level	As per ISO 13849	Reliable detection and evaluation of input statuses up to Cat 4 and PL e	
Failure rate per hour (PFH)	1.0x 10 ⁻⁹		
Certificate-issuing authority	01/205/5444.01/21		
LED indicators	Group diagnostics	1	
	Channel diagnostics	8	
	Channel status	8	
	Fail-safe protocol active	1	
Diagnostics	<ul style="list-style-type: none"> • Short circuit per channel • Undervoltage • Overvoltage • Excessive temperature • Cross circuit per channel • Wire break per channel • Communication • Process data error • Self-test 		
Control elements	DIL switches		
Degree of protection to EN 60529	Dependent on the connection block		
Grid dimension	[mm]	50	
Dimensions (including interlinking block and connection block) W x L x H	[mm]	50 x 107 x 55	
Product weight	[g]	46	

Datasheet – Input module, digital, PROFI-safe

Materials		
Note on materials		RoHS-compliant
LABS (PWIS) conformity		VDMA24364-B2-L
Operating and environmental conditions		
Ambient temperature	[°C]	-5 ... +50
Storage temperature	[°C]	-20 ... +70
CE marking (see declaration of conformity) ¹⁾		To EU Machinery Directive
		To EU EMC Directive
		To EU RoHS Directive
UKCA marking (see declaration of conformity) ¹⁾		According to UK regulations for machines
		To UK EMC regulations
		To UK RoHS regulations
Certification		c UL us - Recognized (OL)

1) More information www.festo.com/catalogue/... → Support/Downloads.

Connection and display components

CPX-F8DE-P

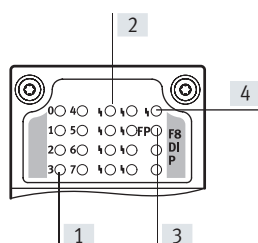

- [1] Channel-oriented status LEDs (green)
- [2] Channel-related error LEDs (red)
- [3] Fail-safe protocol active (green)
- [4] Error LED (red; module error)

Combinations of bus nodes/control blocks with PROFI-safe input module

Bus node/control block	Part no.	PROFI-safe input module
		CPX-F8DE-P
CPX-FB13	195740	■
CPX-FB43	8110369	■
CPX-M-FB44	8110370	■
CPX-M-FB45	8110371	■

Note

The PROFI-safe input module CPX-F8DE-P can only be integrated as of software release 21 or release 30 (in the case of CPX-FB13).

Datasheet – Input module, digital, PROFI-safe

Combinations of connection blocks and PROFI-safe input module		
Connection blocks	Part no.	PROFI-safe input module
		CPX-F8DE-P
CPX-M-AB-4-M12X2-5POL	549367	■
CPX-M-AB-4-M12X2-5POL-T	2639560	■
CPX-AB-8-KL-4POL	195708	■
CPX-AB-ID-P	2639571	■

Pin assignment	
Connection block inputs	CPX-F8DE-P

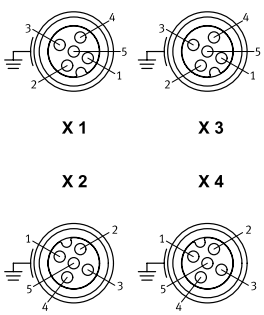
CPX-M-AB-4-M12X2-5POL		
 <p>X 1 X 3</p> <p>X 2 X 4</p>	<p>X1.1: 24 V_{SEN}</p> <p>X1.2: Input x+1</p> <p>X1.3: 0 V_{SEN}</p> <p>X1.4: Input x</p> <p>X1.5: FE</p> <p>X2.1: 24 V_{SEN}</p> <p>X2.2: Input x+3</p> <p>X2.3: 0 V_{SEN}</p> <p>X2.4: Input x+2</p> <p>X2.5: FE</p>	<p>X3.1: 24 V_{SEN}</p> <p>X3.2: Input x+5</p> <p>X3.3: 0 V_{SEN}</p> <p>X3.4: Input x+4</p> <p>X3.5: FE</p> <p>X4.1: 24 V_{SEN}</p> <p>X4.2: Input x+7</p> <p>X4.3: 0 V_{SEN}</p> <p>X4.4: Input x+6</p> <p>X4.5: FE</p>

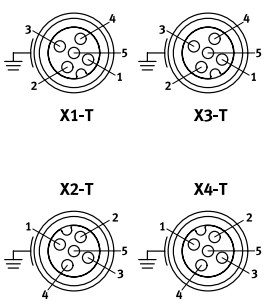
CPX-M-AB-4-M12X2-5POL-T		
 <p>X1-T X3-T</p> <p>X2-T X4-T</p>	<p>X1-T.1: 24 V_{SEN x}</p> <p>X1-T.2: Input x+1</p> <p>X1-T.3: 0 V_{SEN}</p> <p>X1-T.4: Input x</p> <p>X1-T.5: 24 V_{SEN x+1}</p> <p>X2-T.1: 24 V_{SEN x+2}</p> <p>X2-T.2: Input x+3</p> <p>X2-T.3: 0 V_{SEN}</p> <p>X2-T.4: Input x+2</p> <p>X2-T.5: 24 V_{SEN x+3}</p>	<p>X3-T.1: 24 V_{SEN x+4}</p> <p>X3-T.2: Input x+5</p> <p>X3-T.3: 0 V_{SEN}</p> <p>X3-T.4: Input x+4</p> <p>X3-T.5: 24 V_{SEN x+5}</p> <p>X4-T.1: 24 V_{SEN x+6}</p> <p>X4-T.2: Input x+7</p> <p>X4-T.3: 0 V_{SEN}</p> <p>X4-T.4: Input x+6</p> <p>X4-T.5: 24 V_{SEN x+7}</p>

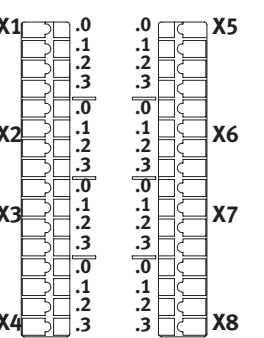
CPX-AB-8-KL-4POL		
 <p>X1 X5</p> <p>X2 X6</p> <p>X3 X7</p> <p>X4 X8</p>	<p>X1.0: 24 V_{SEN}</p> <p>X1.1: 0 V_{SEN}</p> <p>X1.2: Input x</p> <p>X1.3: FE</p> <p>X2.0: 24 V_{SEN x}</p> <p>X2.1: 24 V_{SEN x+1}</p> <p>X2.2: Input x+1</p> <p>X2.3: FE</p> <p>X3.0: 24 V_{SEN}</p> <p>X3.1: 0 V_{SEN}</p> <p>X3.2: Input x+2</p> <p>X3.3: FE</p> <p>X4.0: 24 V_{SEN x+2}</p> <p>X4.1: 24 V_{SEN x+3}</p> <p>X4.2: Input x+3</p> <p>X4.3: FE</p>	<p>X5.0: 24 V_{SEN}</p> <p>X5.1: 0 V_{SEN}</p> <p>X5.2: Input x+4</p> <p>X5.3: FE</p> <p>X6.0: 24 V_{SEN x+4}</p> <p>X6.1: 24 V_{SEN x+5}</p> <p>X6.2: Input x+5</p> <p>X6.3: FE</p> <p>X7.0: 24 V_{SEN}</p> <p>X7.1: 0 V_{SEN}</p> <p>X7.2: Input x+6</p> <p>X7.3: FE</p> <p>X8.0: 24 V_{SEN x+6}</p> <p>X8.1: 24 V_{SEN x+7}</p> <p>X8.2: Input x+7</p> <p>X8.3: FE</p>





Datasheet – Input module, digital, PROFIsafe

General technical data	
Type	CPX-AB-ID-P
Certificate-issuing authority	01/205/5444.00/15 German Technical Control Board (TÜV) Rh. UK 01/205U/5444.00/22
Degree of protection to EN 60529	IP65
Housing material	PA PC
Note on materials	RoHS-compliant
LABS (PWIS) conformity	VDMA24364-B2-L
Corrosion resistance class CRC1)	1
Product weight	[g] 57

1) More information www.festo.com/x/topic/crc

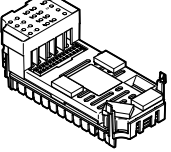
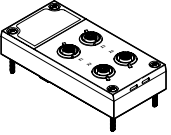
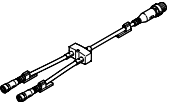
Combinations of interlinking blocks and PROFIsafe input module		
Interlinking blocks	Part no.	PROFIsafe input module
		CPX-F8DE-P
CPX-GE-EV-S	195746	–
CPX-GE-EV-S-VL	8022170	–
CPX-GE-EV-S-7/8-4POL	541248	–
CPX-GE-EV-S-7/8-5POL	541244	–
CPX-GE-EV-S-7/8-5POL-VL	8022172	–
CPX-M-GE-EV-S-7/8-CIP-4P	568956	■
CPX-M-GE-EV-S-7/8-5POL	550208	■
CPX-M-GE-EV-S-7/8-5POL-VL	8022165	■
CPX-M-GE-EV-S-M12-5POL	8098392	■
CPX-M-GE-EV-S-PP-5POL	563057	■
CPX-GE-EV	195742	–
CPX-M-GE-EV	550206	■
CPX-M-GE-EV-FVO	567806	–
CPX-GE-EV-Z	195744	–
CPX-GE-EV-Z-7/8-4POL	541250	–
CPX-GE-EV-Z-7/8-5POL	541246	–
CPX-M-GE-EV-Z-7/8-5POL	550210	■
CPX-M-GE-EV-Z-PP-5POL	563058	■
CPX-GE-EV-V	533577	–
CPX-M-GE-EV-W-M12-5POL	8098391	■

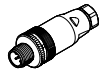
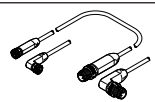
Datasheet – Input module, digital, PROFI-safe

Ordering data		Description	Part no.	Type	
PROFI-safe input module					
	8 digital inputs, positive logic (PNP), for reliable detection and evaluation of input statuses		2597424	CPX-F8DE-P	
Connection block					
	Polymer	Spring-loaded terminal, 32-pin	195708	CPX-AB-8-KL-4POL	
		DIL switch, 8-way	2639571	CPX-AB-ID-P	
	Metal	4x socket M12, 5-pin	Unpulsed sensor supply	549367	CPX-M-AB-4-M12X2-5POL
			Pulsed sensor supply	2639560	CPX-M-AB-4-M12X2-5POL-T
Distributor					
	Modular system for all types of sensor/actuator distributor		–	NEDY-... → Internet: nedy	
	1x plug M12, 4-pin	2x socket M12, 5-pin	8005310	NEDY-L2R1-V1-M12G5-N-M12G4	
Plug					
	M12, 4-pin	For cable Ø 2.1 ... 7 mm	8162294	NECB-S-M12G4-C2	
		For 2x cable Ø 2.1 ... 5.6 mm	8162295	NECB-S-M12G4-C2-D	
	M12, 5-pin	For cable Ø 2.1 ... 7 mm	8162296	NECB-S-M12G5-C2	
		For 2x cable Ø 2.1 ... 5.6 mm	8162297	NECB-S-M12G5-C2-D	
Connecting cable					
	Modular system for a choice of connecting cables		–	NEBA-... → Internet: neba	
User documentation					
	User documentation for PROFI-safe input module		German	8035496 CPX-F8DE-P-DE	
			English	8035497 CPX-F8DE-P-EN	

Datasheet – Input module, digital, 16 inputs

Function

Digital input modules enable the connection of two-wire and three-wire sensors (proximity switches, inductive or capacitive sensors, etc.). Depending on the connection block selected, the module supports various connection concepts with different numbers of sockets (single or double allocation).

Area of application

- Input modules for 24 V DC sensor supply voltage
- PNP logic
- Module features can be parameterised
- The input module receives the voltage supply for the electronics and the sensors from the interlinking block
- Module protection and diagnostics through integrated electronic fuse

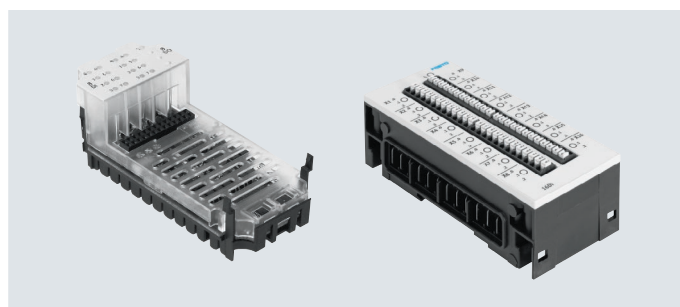

General technical data			CPX-16DE	CPX-M-16DE-D	CPX-L-16DE
Type					
Number of inputs			16	16	16
Max. total current of inputs per module		[A]	1.8	1.8	1.8
Intrinsic current consumption at operating voltage		[mA]	Typ. 15	Typ. 34	Typ. 15
Fuse protection			Internal electronic fuse per module	Internal electronic fuse per channel pair, additional safety fuse	Internal electronic fuse per module
Nominal operating voltage		[V DC]	24	24	24
Operating voltage range		[V DC]	18 ... 30	18 ... 30	18 ... 30
Galvanic isolation	Channel – channel		No	No	No
	Channel – internal bus		No	No	No
Switching level	Signal 0	[V DC]	≤ 5	≤ 5	≤ 5
	Signal 1	[V DC]	≥ 11	≥ 11	≥ 15
Input debounce time		[ms]	3 (0.1 ms, 10 ms, 20 ms parameterisable)		
Input characteristic			IEC 1131-T2	IEC 1131-T2	IEC 1131-T2, type 01
Switching logic			Positive logic (PNP)	Positive logic (PNP)	Positive logic (PNP)
LED indicators	Group diagnostics		1	1	1
	Channel diagnostics		–	16	–
	Channel status		16	16	16
Diagnostics			Short circuit/overload per channel		
Parameterisation			<ul style="list-style-type: none"> • Module monitoring • Behaviour after short circuit • Input debounce time • Signal extension time 		
Degree of protection to EN 60529			Dependent on the connection block	Dependent on the connection block	IP20
Temperature range	Operation	[°C]	–5 ... +50	–5 ... +50	–5 ... +50
	Storage/transport	[°C]	–20 ... +70	–20 ... +70	–20 ... +70
Certification			–	–	c UL us - Listed (OL)
Materials			Reinforced PA, PC	Reinforced PA, PC	Reinforced PA
Note on materials			–	–	RoHS-compliant
LABS (PWIS) conformity			VDMA24364-B2-L	VDMA24364-B2-L	VDMA24364-B2-L
Grid dimension		[mm]	50	50	50
Dimensions (including interlinking block and connection block) W x L x H		[mm]	50 x 107 x 50	50 x 107 x 50	50 x 107 x 41
Product weight		[g]	41	46	167

Datasheet – Input module, digital, 16 inputs

Connection and display components

CPX-16DE

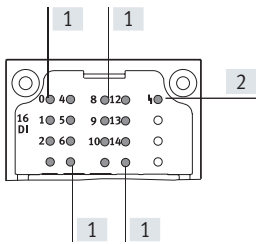

- [1] Status LEDs (green) Assignment to inputs → Pin assignment of the module
- [2] Error LED (red; module error)

CPX-M-16DE-D

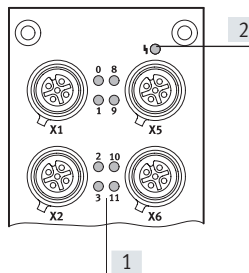

- [1] Common status LEDs (green)/error LEDs (red) for each input signal
- [2] Error LED (red; module error)

CPX-L-16DE

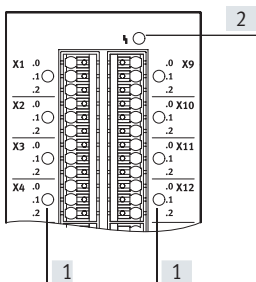

- [1] Status LEDs (green) for each input signal
- [2] Error LED (red; module error)

Combinations of connection blocks and digital input modules

Connection blocks	Part no.	Digital input modules		
		CPX-16DE	CPX-M-16DE-D	CPX-L-16DE
CPX-AB-8-M8X2-4POL	541256	■	–	–
CPX-AB-8-M12X2-5POL	3606900	–	■	–
CPX-AB-8-KL-4POL	195708	■	–	–
CPX-AB-1-SUB-BU-25POL	525676	■	–	–
CPX-M-AB-8-M12X2-5POL	549335	–	■	–

Datasheet – Input module, digital, 16 inputs

Pin assignment		CPX-16DE
Connection block inputs		
CPX-AB-8-M8x2-4POL		
	X1.1: 24 V _{SEN} X1.2: Input x+1 X1.3: 0 V _{SEN} X1.4: Input x X2.1: 24 V _{SEN} X2.2: Input x+3 X2.3: 0 V _{SEN} X2.4: Input x+2 X3.1: 24 V _{SEN} X3.2: Input x+5 X3.3: 0 V _{SEN} X3.4: Input x+4 X4.1: 24 V _{SEN} X4.2: Input x+7 X4.3: 0 V _{SEN} X4.4: Input x+6	X5.1: 24 V _{SEN} X5.2: Input x+9 X5.3: 0 V _{SEN} X5.4: Input x+8 X6.1: 24 V _{SEN} X6.2: Input x+11 X6.3: 0 V _{SEN} X6.4: Input x+10 X7.1: 24 V _{SEN} X7.2: Input x+13 X7.3: 0 V _{SEN} X7.4: Input x+12 X8.1: 24 V _{SEN} X8.2: Input x+15 X8.3: 0 V _{SEN} X8.4: Input x+14
CPX-AB-8-KL-4POL		
	X1.0: Input x+8 X1.1: 24 V _{SEN} X1.2: Input x X1.3: FE X2.0: Input x+9 X2.1: 24 V _{SEN} X2.2: Input x+1 X2.3: FE X3.0: Input x+10 X3.1: 24 V _{SEN} X3.2: Input x+2 X3.3: FE X4.0: Input x+11 X4.1: 24 V _{SEN} X4.2: Input x+3 X4.3: FE	X5.0: Input x+12 X5.1: 0 V _{SEN} X5.2: Input x+4 X5.3: FE X6.0: Input x+13 X6.1: 0 V _{SEN} X6.2: Input x+5 X6.3: FE X7.0: Input x+14 X7.1: 0 V _{SEN} X7.2: Input x+6 X7.3: FE X8.0: Input x+15 X8.1: 0 V _{SEN} X8.2: Input x+7 X8.3: FE
CPX-AB-1-SUB-BU-25POL		
	1: Input x 2: Input x+1 3: Input x+2 4: Input x+3 5: Input x+9 6: 24 V _{SEN} 7: Input x+11 8: 24 V _{SEN} 9: Input x+8 10: Input x+10 11: 24 V _{SEN} 12: 24 V _{SEN} 13: FE	14: Input x+4 15: Input x+5 16: Input x+6 17: Input x+7 18: Input x+12 19: Input x+13 20: Input x+14 21: Input x+15 22: 0 V _{SEN} 23: 0 V _{SEN} 24: 0 V _{SEN} 25: FE Housing: FE



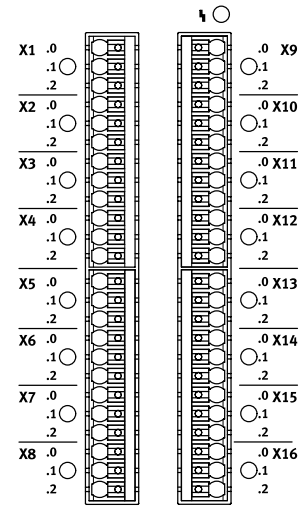

Datasheet – Input module, digital, 16 inputs

Pin assignment		CPX-M-16DE-D	
Connection block inputs		CPX-M-AB-8-M12X2-5POL and CPX-AB-8-M12X2-5POL	
		X1.1: 24 V _{Sx}	X5.1: 24 V _{Sx+8}
		X1.2: Input x+1	X5.2: Input x+9
		X1.3: 0 V _{Sx}	X5.3: 0 V _{Sx+8}
		X1.4: Input x	X5.4: Input x+8
		X1.5: FE	X5.5: FE
		X2.1: 24 V _{Sx+2}	X6.1: 24 V _{Sx+10}
		X2.2: Input x+3	X6.2: Input x+11
		X2.3: 0 V _{Sx+2}	X6.3: 0 V _{Sx+10}
		X2.4: Input x+2	X6.4: Input x+10
		X2.5: FE	X6.5: FE
		X3.1: 24 V _{Sx+4}	X7.1: 24 V _{Sx+12}
		X3.2: Input x+5	X7.2: Input x+13
		X3.3: 0 V _{Sx+4}	X7.3: 0 V _{Sx+12}
		X3.4: Input x+4	X7.4: Input x+12
		X3.5: FE	X7.5: FE
		X4.1: 24 V _{Sx+6}	X8.1: 24 V _{Sx+14}
		X4.2: Input x+7	X8.2: Input x+15
		X4.3: 0 V _{Sx+6}	X8.3: 0 V _{Sx+14}
		X4.4: Input x+6	X8.4: Input x+14
		X4.5: FE	X8.5: FE

Datasheet – Input module, digital, 16 inputs

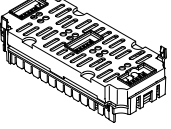
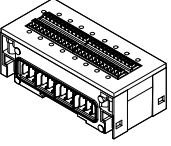
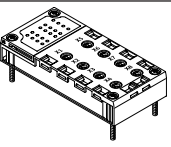
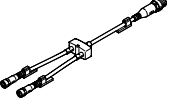
Pin assignment		CPX-L-16DE							
Connection block inputs									
	X1	.0	X9	.0	X1.0:	24 V _{SEN}	X9.0:	24 V _{SEN}	
		.1		.1	X1.1:	Input x	X9.1:	Input x+8	
		.2		.2	X1.2:	0 V _{SEN}	X9.2:	0 V _{SEN}	
	X2	.0		.0	X10	X2.0:	24 V _{SEN}	X10.0:	24 V _{SEN}
		.1		.1	X11	X2.1:	Input x+1	X10.1:	Input x+9
		.2		.2	X12	X2.2:	0 V _{SEN}	X10.2:	0 V _{SEN}
	X3	.0		.0	X13	X3.0:	24 V _{SEN}	X11.0:	24 V _{SEN}
		.1		.1	X14	X3.1:	Input x+2	X11.1:	Input x+10
		.2		.2	X15	X3.2:	0 V _{SEN}	X11.2:	0 V _{SEN}
	X4	.0		.0	X16	X4.0:	24 V _{SEN}	X12.0:	24 V _{SEN}
		.1		.1		X4.1:	Input x+3	X12.1:	Input x+11
		.2		.2		X4.2:	0 V _{SEN}	X12.2:	0 V _{SEN}
	X5	.0		.0		X5.0:	24 V _{SEN}	X13.0:	24 V _{SEN}
		.1		.1		X5.1:	Input x+4	X13.1:	Input x+12
		.2		.2		X5.2:	0 V _{SEN}	X13.2:	0 V _{SEN}
	X6	.0		.0		X6.0:	24 V _{SEN}	X14.0:	24 V _{SEN}
	.1		.1		X6.1:	Input x+5	X14.1:	Input x+13	
	.2		.2		X6.2:	0 V _{SEN}	X14.2:	0 V _{SEN}	
X7	.0		.0		X7.0:	24 V _{SEN}	X15.0:	24 V _{SEN}	
	.1		.1		X7.1:	Input x+6	X15.1:	Input x+14	
	.2		.2		X7.2:	0 V _{SEN}	X15.2:	0 V _{SEN}	
X8	.0		.0		X8.0:	24 V _{SEN}	X16.0:	24 V _{SEN}	
	.1		.1		X8.1:	Input x+7	X16.1:	Input x+15	
	.2		.2		X8.2:	0 V _{SEN}	X16.2:	0 V _{SEN}	

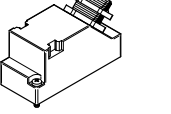
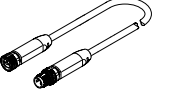
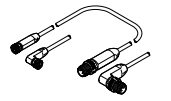
Datasheet – Input module, digital, 16 inputs

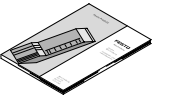
Ordering data				
Designation			Part no.	Type
Input module, digital				
	16 digital inputs, internal electronic fuse per module		543815	CPX-16DE
	16 digital inputs, internal electronic fuse per channel pair, for CPX in metal		550202	CPX-M-16DE-D
	16 digital inputs, internal electronic fuse per module, for CPX in polymer, including interlinking block and connection block with spring-loaded terminals		572606	CPX-L-16DE-16-KL-3POL
Connection block				
	Polymer	8x socket M8, 4-pin	541256	CPX-AB-8-M8X2-4POL
		8x socket M12, 5-pin	3606900	CPX-AB-8-M12X2-5POL
		Spring-loaded terminal, 32-pin	195708	CPX-AB-8-KL-4POL
		1x socket, Sub-D, 25-pin	525676	CPX-AB-1-SUB-BU-25POL
	Metal	8x socket M12, 5-pin	549335	CPX-M-AB-8-M12X2-5POL
Distributor				
	Modular system for all types of sensor/actuator distributor		–	NEDY-... → Internet: nedy
	1x plug M8, 4-pin	2x socket M8, 3-pin	8005312	NEDY-L2R1-V1-M8G3-N-M8G4
Plug				
	M8, 3-pin	Screw terminal	8162298	NECB-S-M8G3-C2
	Sub-D plug, 25-pin		527522	SD-SUB-D-ST25
Connecting cable				
	1x socket M8, 3-pin	1x plug M8, 3-pin	0.5 m	★ 8078282 NEBA-M8G3-U-0.5-N-M8G3
			1.0 m	★ 8078283 NEBA-M8G3-U-1-N-M8G3
			2.5 m	★ 8078286 NEBA-M8G3-U-2.5-N-M8G3
			5.0 m	★ 8078287 NEBA-M8G3-U-5-N-M8G3
	Modular system for a choice of connecting cables		–	NEBA-... → Internet: neba
Covering				
	Covering hood for CPX-AB-8-KL-4POL (IP65, IP67)		538219	AK-8KL
	<ul style="list-style-type: none"> 8 cable through-feeds M9 1 cable through-feed for multi-pin plug Fittings kit		538220	VG-K-M9
User documentation				
	User documentation	German	526439	CPX_DE_DA/CPX_DE-DE
		English	526440	CPX_DE_DA/CPX_DE-EN

Datasheet – Output module, digital

Function

Digital outputs control actuators such as individual valves, hydraulic valves, heating controllers and many more. Separate circuits are created using additional power supply. By connecting the outputs of a module in parallel, consuming devices can be controlled with up to 4 A.

Area of application

- Output module for 24 V DC supply voltage
- PNP logic
- Module features can be parameterised
- The output module receives the voltage supply for the electronics and the outputs from the interlinking block
- Module protection and diagnostics through integrated electronic fuse in each channel

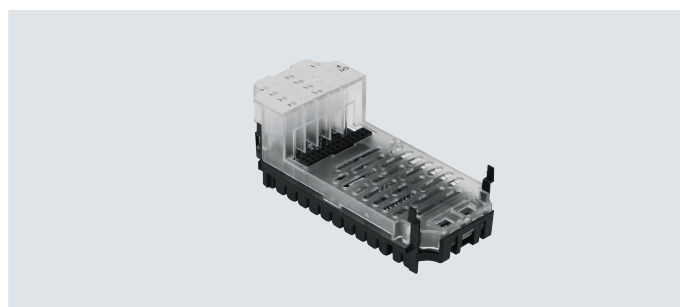

General technical data		CPX-4DA	CPX-8DA	CPX-8DA-H
Type				
Number of outputs		4	8	8
Max. power supply	Per module [A]	4		8.4
	Per channel [A]	1 (24 W lamp load, 4 channels can be connected in parallel)	0.5 (12 W lamp load, 8 channels can be connected in parallel)	2.1 (50 W lamp load), per channel pair
Fuse protection (short circuit)		Internal electronic fuse per channel		
Module current consumption (power supply for electronics)	[mA]	Typically 16		Typ. 34
Operating voltage	Nominal width [V DC]	24		
	Permissible range [V DC]	18 ... 30		
Galvanic isolation	Channel – channel	No		
	Channel – internal bus	Yes, with intermediate air supply		
Output characteristic		Based on IEC 1131-2		
Switching logic		Positive logic (PNP)		
LED indicators	Group diagnostics	1	1	1
	Channel diagnostics	4	8	8
	Channel status	4	8	8
Diagnostics		<ul style="list-style-type: none"> • Short circuit/overload, channel x • Undervoltage of outputs 		
Parameterisation		<ul style="list-style-type: none"> • Module monitoring • Behaviour after short circuit • Fail-safe channel x • Force channel x • Idle mode channel x 		
Degree of protection to EN 60529		Dependent on the connection block		
Temperature range	Operation [°C]	–5 ... +50		
	Storage/transport [°C]	–20 ... +70		
Materials		Reinforced PA, PC		
LABS (PWIS) conformity		VDMA24364-B2-L		
Grid dimension	[mm]	50		
Dimensions (including interlinking block and connection block) W x L x H	[mm]	50 x 107 x 50		
Product weight	[g]	42	49	48

Datasheet – Output module, digital

Connection and display components

CPX-4DA

CPX-8DA

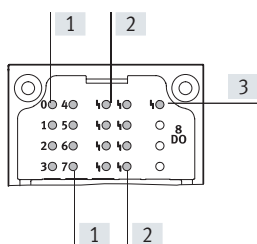
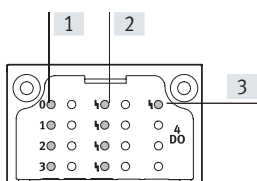

- [1] Status LEDs (yellow) Assignment to outputs → Pin assignment of the module
- [2] Channel-related error LEDs (red)
- [3] Error LED (red, module error)

Combinations of connection block and digital output module

Connection blocks	Part no.	Digital output module		
		CPX-4DA	CPX-8DA	CPX-8DA-H
CPX-AB-8-M8-3POL	195706	■	■	–
CPX-AB-8-M8X2-4POL	541256	■	■	■
CPX-AB-4-M12X2-5POL	195704	■	■	–
CPX-AB-4-M12X2-5POL-R	541254	■	■	■
CPX-AB-8-KL-4POL	195708	■	■	■
CPX-AB-1-SUB-BU-25POL	525676	■	■	■
CPX-M-AB-4-M12X2-5POL	549367	■	■	■

Pin assignment

Connection block outputs	CPX-4DA		CPX-8DA	
CPX-AB-8-M8-3POL				
	X1.1: n.c.	X5.1: n.c.	X1.1: n.c.	X5.1: n.c.
	X1.3: 0 V _{OUT}	X5.3: 0 V _{OUT}	X1.3: 0 V _{OUT}	X5.3: 0 V _{OUT}
	X1.4: Output x	X5.4: Output x+2	X1.4: Output x	X5.4: Output x+4
	X2.1: n.c.	X6.1: n.c.	X2.1: n.c.	X6.1: n.c.
	X2.3: 0 V _{OUT}	X6.3: 0 V _{OUT}	X2.3: 0 V _{OUT}	X6.3: 0 V _{OUT}
	X2.4: Output x+1	X6.4: Output x+3	X2.4: Output x+1	X6.4: Output x+5
	X3.1: n.c.	X7.1: n.c.	X3.1: n.c.	X7.1: n.c.
	X3.3: 0 V _{OUT}	X7.3: 0 V _{OUT}	X3.3: 0 V _{OUT}	X7.3: 0 V _{OUT}
	X3.4: Output x+1	X7.4: Output x+3	X3.4: Output x+2	X7.4: Output x+6
	X4.1: n.c.	X8.1: n.c.	X4.1: n.c.	X8.1: n.c.
	X4.3: 0 V _{OUT}	X8.3: 0 V _{OUT}	X4.3: 0 V _{OUT}	X8.3: 0 V _{OUT}
	X4.4: n.c.	X8.4: n.c.	X4.4: Output x+3	X8.4: Output x+7

Datasheet – Output module, digital

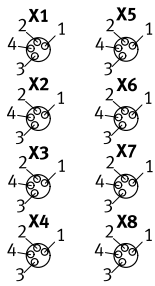
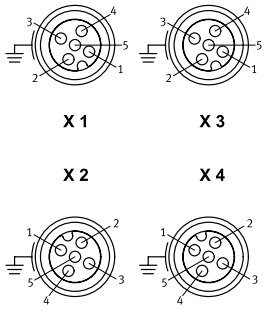
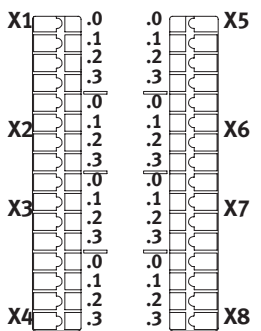
Pin assignment	CPX-4DA		CPX-8DA and CPX-8DA-H	
Connection block outputs				
CPX-AB-8-M8X2-4POL				
	X1.1: 0 V _{OUT} X1.2: Output x+1 X1.3: 0 V _{OUT} X1.4: Output x X2.1: 0 V _{OUT} X2.2: n.c. X2.3: 0 V _{OUT} X2.4: Output x+1 X3.1: 0 V _{OUT} X3.2: Output x+3 X3.3: 0 V _{OUT} X3.4: Output x+2 X4.1: 0 V _{OUT} X4.2: n.c. X4.3: 0 V _{OUT} X4.4: Output x+3	X5.1: 0 V _{OUT} X5.2: n.c. X5.3: 0 V _{OUT} X5.4: n.c. X6.1: 0 V _{OUT} X6.2: n.c. X6.3: 0 V _{OUT} X6.4: n.c. X7.1: 0 V _{OUT} X7.2: n.c. X7.3: 0 V _{OUT} X7.4: n.c. X8.1: 0 V _{OUT} x+1 X8.2: n.c. X8.3: 0 V _{OUT} x+3 X8.4: n.c.	X1.1: 0 V _{OUT} X1.2: Output x+1 X1.3: 0 V _{OUT} X1.4: Output x X2.1: 0 V _{OUT} X2.2: Output x+3 X2.3: 0 V _{OUT} X2.4: Output x+2 X3.1: 0 V _{OUT} X3.2: Output x+5 X3.3: 0 V _{OUT} X3.4: Output x+4 X4.1: 0 V _{OUT} X4.2: Output x+7 X4.3: 0 V _{OUT} X4.4: Output x+6	X5.1: 0 V _{OUT} X5.2: n.c. X5.3: 0 V _{OUT} X5.4: n.c. X6.1: 0 V _{OUT} X6.2: n.c. X6.3: 0 V _{OUT} X6.4: n.c. X7.1: 0 V _{OUT} X7.2: n.c. X7.3: 0 V _{OUT} X7.4: n.c. X8.1: 0 V _{OUT} X8.2: n.c. X8.3: 0 V _{OUT} X8.4: n.c.
CPX-AB-4-M12X2-5POL¹⁾ and CPX-AB-4-M12X2-5POL-R²⁾				
	X1.1: n.c. X1.2: Output x+1 X1.3: 0 V _{OUT} X1.4: Output x X1.5: FE X2.1: n.c. X2.2: n.c. X2.3: 0 V _{OUT} X2.4: Output x+1 X2.5: FE	X3.1: n.c. X3.2: Output x+3 X3.3: 0 V _{OUT} X3.4: Output x+2 X3.5: FE X4.1: n.c. X4.2: n.c. X4.3: 0 V _{OUT} X4.4: Output x+3 X4.5: FE	X1.1: n.c. X1.2: Output x+1 X1.3: 0 V _{OUT} X1.4: Output x X1.5: FE X2.1: n.c. X2.2: Output x+3 X2.3: 0 V _{OUT} X2.4: Output x+2 X2.5: FE	X3.1: n.c. X3.2: Output x+5 X3.3: 0 V _{OUT} X3.4: Output x+4 X3.5: FE X4.1: n.c. X4.2: Output x+7 X4.3: 0 V _{OUT} X4.4: Output x+6 X4.5: FE
CPX-AB-8-KL-4POL				
	X1.0: n.c. X1.1: 0 V _{OUT} X1.2: Output x X1.3: FE X2.0: n.c. X2.1: 0 V _{OUT} X2.2: Output x+1 X2.3: FE X3.0: n.c. X3.1: 0 V _{OUT} X3.2: Output x+1 X3.3: FE X4.0: n.c. X4.1: 0 V _{OUT} X4.2: n.c. X4.3: FE	X5.0: n.c. X5.1: 0 V _{OUT} X5.2: Output x+2 X5.3: FE X6.0: n.c. X6.1: 0 V _{OUT} X6.2: Output x+3 X6.3: FE X7.0: n.c. X7.1: 0 V _{OUT} X7.2: Output x+3 X7.3: FE X8.0: n.c. X8.1: 0 V _{OUT} X8.2: n.c. X8.3: FE	X1.0: n.c. X1.1: 0 V _{OUT} X1.2: Output x X1.3: FE X2.0: n.c. X2.1: 0 V _{OUT} X2.2: Output x+1 X2.3: FE X3.0: n.c. X3.1: 0 V _{OUT} X3.2: Output x+2 X3.3: FE X4.0: n.c. X4.1: 0 V _{OUT} X4.2: Output x+3 X4.3: FE	X5.0: n.c. X5.1: 0 V _{OUT} X5.2: Output x+4 X5.3: FE X6.0: n.c. X6.1: 0 V _{OUT} X6.2: Output x+5 X6.3: FE X7.0: n.c. X7.1: 0 V _{OUT} X7.2: Output x+6 X7.3: FE X8.0: n.c. X8.1: 0 V _{OUT} X8.2: Output x+7 X8.3: FE



1) Not suitable for CPX-8DA-H.

2) Speedcon quick lock, additional shielding on metal thread

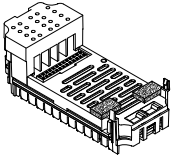
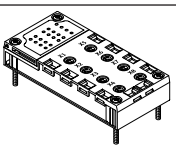
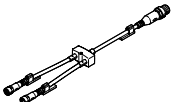

Datasheet – Output module, digital

Pin assignment		CPX-4DA		CPX-8DA and CPX-8DA-H			
Connection block outputs		CPX-4DA		CPX-8DA and CPX-8DA-H			
CPX-AB-1-SUB-BU-25POL							
	1:	Output x	14:	Output x+2	1:	Output x	
	2:	Output x+1	15:	Output x+3	2:	Output x+1	
	3:	Output x+1	16:	Output x+3	3:	Output x+2	
	4:	n.c.	17:	n.c.	4:	Output x+3	
	5:	n.c.	18:	n.c.	5:	n.c.	
	6:	0 V _{OUT}	19:	n.c.	6:	0 V _{OUT}	
	7:	n.c.	20:	n.c.	7:	n.c.	
	8:	0 V _{OUT}	21:	n.c.	8:	0 V _{OUT}	
	9:	n.c.	22:	0 V _{OUT}	9:	n.c.	
	10:	n.c.	23:	0 V _{OUT}	10:	n.c.	
	11:	0 V _{OUT}	24:	0 V _{OUT}	11:	0 V _{OUT}	
	12:	0 V _{OUT}	25:	FE	12:	0 V _{OUT}	
	13:	FE	Housing:	FE	13:	FE	
						14:	Output x+4
						15:	Output x+5
						16:	Output x+6
						17:	Output x+7
						18:	n.c.
						19:	n.c.
						20:	n.c.
						21:	n.c.
						22:	0 V _{OUT}
						23:	0 V _{OUT}
						24:	0 V _{OUT}
						25:	FE
						Housing:	FE

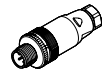
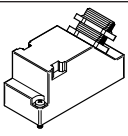
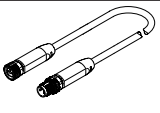
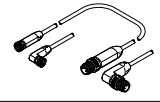
Datasheet – Output module, digital

Ordering data				Part no.	Type
Designation					
Output module, digital					
	4 digital outputs, power supply 1 A per channel		195754	CPX-4DA	
	8 digital outputs, power supply 0.5 A per channel		541482	CPX-8DA	
	8 digital outputs, power supply 2.1 A per channel pair		550204	CPX-8DA-H	
Connection block					
	Polymer	8x socket M8, 3-pin	195706	CPX-AB-8-M8-3POL	
		8x socket M8, 4-pin	541256	CPX-AB-8-M8X2-4POL	
		4x socket M12, 5-pin	195704	CPX-AB-4-M12X2-5POL	
		4x socket, M12 with quick-lock technology, 5-pin	541254	CPX-AB-4-M12X2-5POL-R	
		Spring-loaded terminal, 32-pin	195708	CPX-AB-8-KL-4POL	
		1x socket, Sub-D, 25-pin	525676	CPX-AB-1-SUB-BU-25POL	
	Metal	4x socket M12, 5-pin	549367	CPX-M-AB-4-M12X2-5POL	
Distributor					
	Modular system for all types of sensor/actuator distributor		–	NEDY-...	→ Internet: nedy
	1x plug M8, 4-pin	2x socket M8, 3-pin	8005312	NEDY-L2R1-V1-M8G3-N-M8G4	
	1x plug M12, 4-pin	2x socket M8, 3-pin	8005311	NEDY-L2R1-V1-M8G3-N-M12G4	
		2x socket M12, 5-pin	8005310	NEDY-L2R1-V1-M12G5-N-M12G4	
Plug					
	M8, 3-pin	Screw terminal	8162298	NECB-S-M8G3-C2	
	M12, 4-pin	For cable Ø 2.1 ... 7 mm	8162294	NECB-S-M12G4-C2	
		For 2x cable Ø 2.1 ... 5.6 mm	8162295	NECB-S-M12G4-C2-D	
	M12, 5-pin	For cable Ø 2.1 ... 7 mm	8162296	NECB-S-M12G5-C2	
For 2x cable Ø 2.1 ... 5.6 mm		8162297	NECB-S-M12G5-C2-D		
	Sub-D plug, 25-pin		527522	SD-SUB-D-ST25	
Connecting cable					
	1x socket M8, 3-pin	1x plug M8, 3-pin	0.5 m	★ 8078282	NEBA-M8G3-U-0.5-N-M8G3
			1.0 m	★ 8078283	NEBA-M8G3-U-1-N-M8G3
			2.5 m	★ 8078286	NEBA-M8G3-U-2.5-N-M8G3
			5.0 m	★ 8078287	NEBA-M8G3-U-5-N-M8G3
	Modular system for a choice of connecting cables		–	NEBA-...	→ Internet: neba

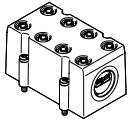
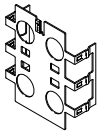
Datasheet – Output module, digital

Ordering data		Part no.	Type
Designation			
Covering			
	Covering hood for CPX-AB-8-KL-4POL (IP65, IP67) • 8 cable through-feeds M9 • 1 cable through-feed for multi-pin plug	538219	AK-8KL
	Fittings kit	538220	VG-K-M9
Screening plate			
	Screening plate for M12 connections	526184	CPX-AB-S-4-M12
User documentation			
	User documentation	German	526439 CPX-_DE_DA/CPX-_DE-DE
		English	526440 CPX-_DE_DA/CPX-_DE-EN

Datasheet – Input/output module, digital

Area of application

- Digital multi I/O module for 24 V DC supply voltage
- Supports connection blocks with Sub-D, terminal connection and M12 connection (8-pin)
- As CPX-L with connection via spring-loaded terminals
- Module features can be parameterised
- The inputs receive the voltage supply for the electronics and the sensors from the interlinking block
- The outputs receive the voltage supply for the electronics and the outputs from the interlinking block
- Module protection and diagnostics through integrated electronic fuse for the sensor power supply and integrated fuse protection in each output channel

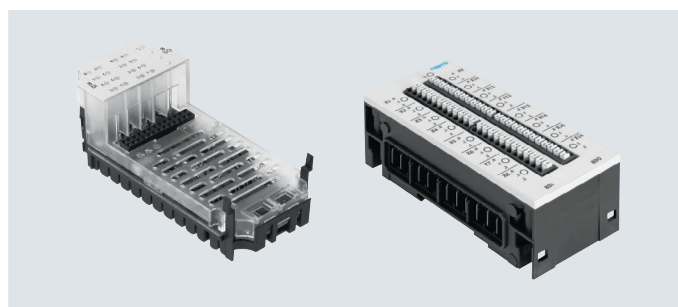

General technical data			CPX-8DE-8DA	CPX-L-8DE-8DA
Type				
No. of	Inputs		8	8
	Outputs		8	8
Max. power supply Per module	Sensor supply	[A]	0.7	1.8
	Outputs	[A]	4	2
Max. power supply per channel		[A]	0.5 (12 W lamp load, channels A0 ... A03 can be connected in parallel to A4 ... A7)	0.25 (6 W lamp load)
Fuse protection (short circuit)			Internal electronic fuse per channel	
Intrinsic current consumption at nominal operating voltage		[mA]	Typ. 22	Typ. 15
Operating voltage	Nominal width	[V DC]	24	24
	Permissible range	[V DC]	18 ... 30	18 ... 30
Electrical isolation, inputs	Channel – channel		No	No
	Channel – internal bus		No	No
Electrical isolation, outputs	Channel – channel		No	No
	Channel – internal bus		Yes, with intermediate air supply	No
Characteristic curve	Inputs		IEC 1131-T2	IEC 1131-T2, type 01
	Outputs		IEC 1131-T2	IEC 1131-T2
Switching level, inputs	Signal 0	[V DC]	≤ 5	≤ 5
	Signal 1	[V DC]	≥ 11	≥ 15
Input debounce time		[ms]	3 (0.1 ms, 10 ms, 20 ms parameterisable)	
Switching logic			Positive logic (PNP)	Positive logic (PNP)
LED indicators	Group diagnostics		1	1
	Channel diagnostics		–	–
	Channel status		16	16
Diagnostics			<ul style="list-style-type: none"> • Short circuit/overload per channel • Undervoltage of outputs 	
Parameterisation			<ul style="list-style-type: none"> • Input debounce time • Fail-safe per channel • Forcing per channel • Idle mode per channel • Signal extension time • Module monitoring • Behaviour after short circuit 	
Degree of protection to EN 60529			Depending on connection block	IP20
Temperature range	Operation	[°C]	–5 ... +50	–5 ... +50
	Storage/transport	[°C]	–20 ... +70	–20 ... +70
Certification			–	c UL - Recognized (OL)
Materials			Reinforced PA, PC	Reinforced PA
Note on materials			–	RoHs-compliant
LABS (PWIS) conformity			VDMA24364-B2-L	VDMA24364-B2-L
Grid dimension		[mm]	50	50
Dimensions (including interlinking block and connection block) W x L x H		[mm]	50 x 107 x 50	50 x 107 x 41
Product weight		[g]	48	171

Datasheet – Input/output module, digital

Connection and display components

CPX-8DE-8DA

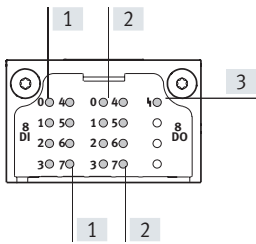

- [1] Status LEDs (green) Assignment to inputs → Pin assignment of the module
- [2] Status LEDs (yellow) Assignment to outputs → Pin assignment of the module
- [3] Error LED (red) (module error)

CPX-L-8DE-8DA

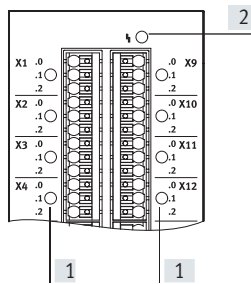

- [1] Status LEDs (green) for each input signal
- [2] Error LED (red; module error)

Combinations of connection blocks and digital I/O module

Connection blocks	Part no.	Digital I/O module	
		CPX-8DE-8DA	CPX-L-8DE-8DA
CPX-AB-4-M12-8POL	526178	■	–
CPX-AB-8-KL-4POL	195708	■	–
CPX-AB-1-SUB-BU-25POL	525676	■	–

Pin assignment

Connection block inputs/outputs

CPX-8DE-8DA

CPX-AB-4-M12-8POL

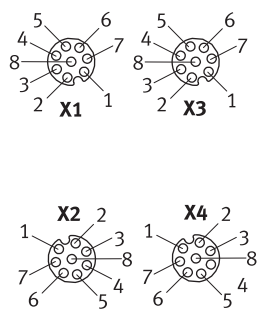

- X1.1: 24 V_{SEN}
- X1.2: Input x
- X1.3: Input x+1
- X1.4: 0 V_{SEN}
- X1.5: Output x
- X1.6: Output x+1
- X1.7: Input x+4
- X1.8: 0 V_{OUT}
- X2.1: 24 V_{SEN}
- X2.2: Input x+2
- X2.3: Input x+3
- X2.4: 0 V_{SEN}
- X2.5: Output x+2
- X2.6: Output x+3
- X2.7: Input x+6
- X2.8: 0 V_{OUT}

- X3.1: 24 V_{SEN}
- X3.2: Input x+4
- X3.3: Input x+5
- X3.4: 0 V_{SEN}
- X3.5: Output x+4
- X3.6: Output x+5
- X3.7: n.c.
- X3.8: 0 V_{OUT}
- X4.1: 24 V_{SEN}
- X4.2: Input x+6
- X4.3: Input x+7
- X4.4: 0 V_{SEN}
- X4.5: Output x+6
- X4.6: Output x+7
- X4.7: n.c.
- X4.8: 0 V_{OUT}

Datasheet – Input/output module, digital

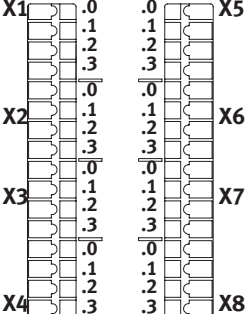
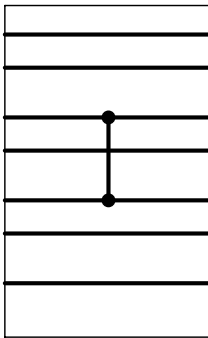
Pin assignment		CPX-8DE-8DA	
CPX-AB-8-KL-4POL			
	<p>X1.0: 24 V_{SEN} X1.1: 0 V_{SEN} X1.2: Input x X1.3: FE</p> <p>X2.0: Input x+4 X2.1: Input x+5 X2.2: Input x+1 X2.3: FE</p> <p>X3.0: 24 V_{SEN} X3.1: 0 V_{SEN} X3.2: Input x+2 X3.3: FE</p> <p>X4.0: Input x+6 X4.1: Input x+7 X4.2: Input x+3 X4.3: FE</p>	<p>X5.0: Output x+4 X5.1: 0 V_{OUT} X5.2: Output x X5.3: FE</p> <p>X6.0: Output x+5 X6.1: 0 V_{OUT} X6.2: Output x+1 X6.3: FE</p> <p>X7.0: Output x+6 X7.1: 0 V_{OUT} X7.2: Output x+2 X7.3: FE</p> <p>X8.0: Output x+7 X8.1: 0 V_{OUT} X8.2: Output x+3 X8.3: FE</p>	
CPX-AB-1-SUB-BU-25POL			
	<p>1: Input x 2: Input x+1 3: Input x+2 4: Input x+3 5: Input x+4 6: Input x+5 7: Input x+6 8: Input x+7 9: 24 V_{SEN} 10: 24 V_{SEN} 11: 0 V_{SEN} 12: 0 V_{SEN} 13: FE</p>	<p>14: Output x 15: Output x+1 16: Output x+2 17: Output x+3 18: Output x+4 19: Output x+5 20: Output x+6 21: Output x+7 22: 0 V_{OUT} 23: 0 V_{OUT} 24: 0 V_{OUT} 25: FE Housing: FE</p>	

Datasheet – Input/output module, digital

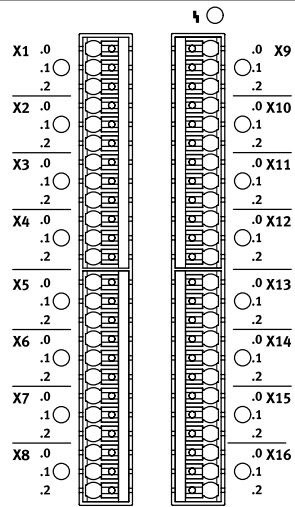
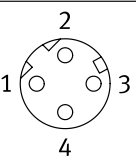
Pin assignment		CPX-L-8DE-8DA	
Connection block inputs 			
X1.0: 24 V _{SEN}	X1.1: Input x	X1.2: 0 V _{SEN} +out	X9.0: 24 V _{SEN}
X2.0: 24 V _{SEN}	X2.1: Input x+1	X2.2: 0 V _{SEN} +out	X9.1: Output x
X3.0: 24 V _{SEN}	X3.1: Input x+2	X3.2: 0 V _{SEN} +out	X9.2: 0 V _{SEN} +out
X4.0: 24 V _{SEN}	X4.1: Input x+3	X4.2: 0 V _{SEN} +out	X10.0: 24 V _{SEN}
X5.0: 24 V _{SEN}	X5.1: Input x+4	X5.2: 0 V _{SEN} +out	X10.1: Output x+1
X6.0: 24 V _{SEN}	X6.1: Input x+5	X6.2: 0 V _{SEN} +out	X10.2: 0 V _{SEN} +out
X7.0: 24 V _{SEN}	X7.1: Input x+6	X7.2: 0 V _{SEN} +out	X11.0: 24 V _{SEN}
X8.0: 24 V _{SEN}	X8.1: Input x+7	X8.2: 0 V _{SEN} +out	X11.1: Output x+2
			X11.2: 0 V _{SEN} +out
			X12.0: 24 V _{SEN}
			X12.1: Output x+3
			X12.2: 0 V _{SEN} +out
			X13.0: 24 V _{SEN}
			X13.1: Output x+4
			X13.2: 0 V _{SEN} +out
			X14.0: 24 V _{SEN}
			X14.1: Output x+5
			X14.2: 0 V _{SEN} +out
			X15.0: 24 V _{SEN}
			X15.1: Output x+6
			X15.2: 0 V _{SEN} +out
			X16.0: 24 V _{S7}
			X16.1: Output x+7
			X16.2: 0 V _{SEN} +out
Interlinking block 		CPX-L-8DE-8DA The module combines the 0 V potential of the power supply for electronics and sensors with the 0 V potential of the power supply for outputs in the CPX interlinking module.	
		If all pins of the outputs of an output module connected to the right of the input/output module are to be switched off, an appropriate interlinking block with additional supply for outputs must be used to the right of the input/output module.	

Datasheet – Input/output module, digital

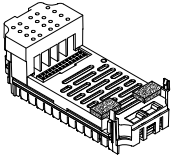
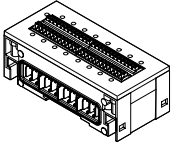
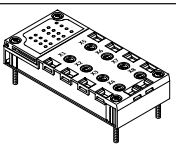
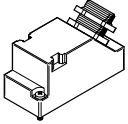
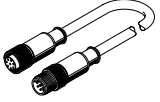
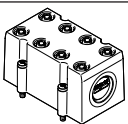
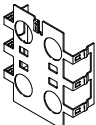
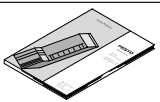
Ordering data		Part no.	Type
Designation			
Input/output module, digital			
	8 digital inputs, 8 digital outputs	526257	CPX-8DE-8DA
	8 digital inputs, 8 digital outputs, for CPX in polymer, including interlinking block and connection block with spring-loaded terminals	572607	CPX-L-8DE-8DA-16-KL-3POL
Connection block			
	Polymer	4x socket M12, 8-pin	526178 CPX-AB-4-M12-8POL
		Spring-loaded terminal, 32-pin	195708 CPX-AB-8-KL-4POL
		1x socket, Sub-D, 25-pin	525676 CPX-AB-1-SUB-BU-25POL
Plug			
	Sub-D plug, 25-pin	527522	SD-SUB-D-ST25
Connecting cable			
	Connecting cable M12	525617	KM12-8GD8GS-2-PU
Covering			
	Covering hood for CPX-AB-8-KL-4POL (IP65, IP67) • 8 cable through-feeds M9 • 1 cable through-feed for multi-pin plug	538219	AK-8KL
		Fittings kit	538220
Screening plate			
	Screening plate for M12 connections	526184	CPX-AB-S-4-M12
User documentation			
	User documentation	German	526439 CPX-DE-DA/CPX-DE-DE
		English	526440 CPX-DE-DA/CPX-DE-EN

Datasheet – Counter module, digital

Function

The counter module has two channels. Depending on the parameterisation, these can independently be used as counter inputs or as incremental value encoder inputs or SSI. The counter module additionally has one output per channel. The outputs can either be controlled by a counter channel or an incremental value encoder channel, i.e. through an event such as "Comparative value reached". Alternatively, outputs can also be controlled via process data.

Area of application

- Continuous counting
- One-off counting up to count limit
- One-off counting to count limit, return to load value
- Periodic counting
- Measuring frequencies
- Measuring rotational speeds
- Measuring duty cycle
- Measuring position
- Measuring speed
- Measuring with pulse generators
- Measurement with pulse generators and direction encoders
- Measurement with incremental encoders
- Measurement with SSI absolute encoders



Description

Possible applications

- | | | | |
|---|--|---|---|
| <ul style="list-style-type: none"> • Recording travel and speed of a conveyor • Position and speed synchronisation of conveyors and pick & place applications • Counting goods e.g. in packaging installations | <ul style="list-style-type: none"> • Systems for filling by weight and volume • Monitoring motor speeds • Measuring equipment for determining the position of axis systems (linear, rotational) | <ul style="list-style-type: none"> • Controlling fast-switching valves • Controlling the opening time of a valve • Activating semiconductor relays | <ul style="list-style-type: none"> • Temperature monitoring and rotational speed control for drives • Change of direction in fast drives • Control of motors with pulse-width modulation (PWM) |
|---|--|---|---|

Supported devices

- | | | | |
|---|--|--|--|
| <ul style="list-style-type: none"> • 5 V incremental encoder, single-ended or differential, with two 90° phase offset tracks | <ul style="list-style-type: none"> • 24 V incremental encoder, single-ended, with two 90° phase offset tracks | <ul style="list-style-type: none"> • 24 V pulse generator with or without direction level • 24 V direct current motors | <ul style="list-style-type: none"> • Absolute encoder with SSI interface (13 bits to 25 bits) |
|---|--|--|--|

Datasheet – Counter module, digital

General technical data			
Type		CPX-2ZE2DA	
No. of	Inputs		2
	Outputs		2
Max. power supply Per module	Inputs	[A]	2
	Outputs	[A]	10
Max. power supply per channel		[A]	5 (adjustable, 20 W lamp load)
Max. cable length		[m]	30
Fuse protection (short circuit)			Internal electronic fuse per channel
Intrinsic current consumption at nominal operating voltage		[mA]	typ. 35
Operating voltage	Nominal width	[V DC]	24
	Permissible range	[V DC]	18 ... 30
Electrical isolation, inputs	Channel – channel		No
	Channel – internal bus		No
Electrical isolation, outputs	Channel – channel		No
	Channel – internal bus		Yes, with intermediate air supply
Characteristic curve	Inputs		To IEC 1131-2, type O2
	Outputs		IEC 1131-T2
Switching level	Signal 0	[V DC]	≤ 5
	Signal 1	[V DC]	≥ 11
Input debounce time		[μs]	0.1 (0.2 μs, 0.4 μs, 0.8 μs, 1 μs, 2 μs, 4 μs, 8 μs, 10 μs, 50 μs, 100 μs, 500 μs, 1 ms, 3 ms, 10 ms, 20 ms parameterisable)
Switching logic	Inputs		Positive logic (PNP)
	Outputs		<ul style="list-style-type: none"> • Negative logic (NPN) • Positive logic (PNP) • Push-pull driver
LED indicators	Group diagnostics		1
	Channel diagnostics		2
	Channel status		10
	Module diagnostics		2
Diagnostics			Operating mode-dependent diagnostics
Parameterisation			<ul style="list-style-type: none"> • Switch-on/off delay • Frequency output • Speed measurement • Pulse output • Pulse train • Rotational speed measurement • Frequency measurement • Period duration measurement • Motor operating mode • Determine position • Pulse-width modulation • One-off counting • Continuous counting • Periodic counting
Degree of protection to EN 60529			IP65, IP67
Temperature range	Operation	[°C]	-5 ... +50
	Storage/transport	[°C]	-20 ... +70
Certification			UL – Recognized (OL)
Information on housing materials			Polymer
Note on materials			RoHS-compliant
LABS (PWIS) conformity			VDMA24364-B2-L
Grid dimension		[mm]	50
Dimensions (including interlinking block and connection block) W x L x H		[mm]	50 x 107 x 50
Product weight		[g]	130

Datasheet – Counter module, digital

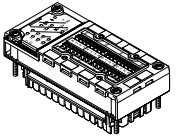
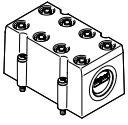
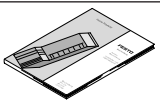
Ordering data		Part no.	Type
Designation			
Counter module, digital			
	2 digital inputs, 2 digital outputs	576046	CPX-2ZE2DA
Covering			
	Cover for CPX-2ZE2DA (IP65, IP67) • 8 cable through-feeds M9 • 1 cable through-feed for multi-pin plug	538219	AK-8KL
	Fittings kit	538220	VG-K-M9
User documentation			
	User documentation for counter module CPX-2ZE2DA	German	8035733 CPX-2ZE2DA-DE
		English	8035734 CPX-2ZE2DA-EN

Datasheet – Input module, analogue

Function

Analogue modules are used to control devices with a standardised analogue interface such as pressure switches, temperature, flow rate, filling level, etc.

Depending on the connection block selected, the analogue module supports various connection concepts with different numbers of sockets or terminals.

Area of application

- Analogue module for 0 ... 10 V, 0 ... 20 mA or 4 ... 20 mA
- Supports connection blocks with Sub-D, terminal connection and M12 connection
- Analogue module features can be parameterised
- Different data formats available
- Operation with and without galvanic isolation possible
- The analogue module receives the voltage supply for the electronics and the sensors from the inter-linking block
- Analogue module protection and diagnostics through integrated electronic fuse

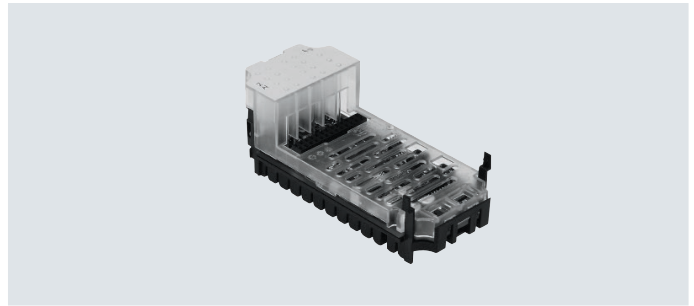

General technical data		CPX-2AE-U-I172		CPX-4AE-U-I		CPX-4AE-I
		Voltage input	Current input	Voltage input	Current input	Current input
Type						
Number of analogue inputs		2		4		4
Max. power supply per module	[A]	0.7				
Fuse protection		Internal electronic fuse				
Current consumption from 24 V sensor supply (quiescent current)	[mA]	Typically 50				
Current consumption from 24 V sensor supply (at full load)	[A]	Max. 0.7				
Nominal operating voltage for load voltage	[V DC]	24 ±2%				
Nominal operating voltage	[V DC]	24				
Operating voltage range	[V DC]	18 ... 30				
Signal range (parameterisable for each channel with DIL switch or software)		0 ... 10 V	0 ... 20 mA 4 ... 20 mA	1 ... 5 V 0 ... 10 V -5 ... +5 V -10 ... +10 V	0 ... 20 mA 4 ... 20 mA -20 ... +20 mA	0 ... 20 mA 4 ... 20 mA
Operational error limit	[%]	±0.5	–	±0.3	±0.3	±0.6
Basic error limit (at 25 °C)	[%]	±0.3	–	±0.2	±0.2	±0.5
Repetition accuracy (at 25 °C)	[%]	0.15	0.15	0.1	0.1	0.15
Input resistance		100 kΩ	≤ 100 Ω	100 kΩ	≤ 100 Ω	≤ 100 Ω
Max. permissible input voltage	[V DC]	30	–	-30 ... +30	–	–
Max. permissible input current	[mA]	–	40	–	internally limited to 60	40
Conversion time per channel	[μs]	Typically 150				
Cycle time (module)	[ms]	≤ 4		≤ 0.5		≤ 10
Data format		12 bits + prefix Scalable to 15 bits		15 bits + prefix Scalable to 15 bits		12 bits + prefix Scalable to 15 bits
Cable length	[m]	Max. 30 (shielded)				

Datasheet – Input module, analogue

General technical data		CPX-2AE-U-I	CPX-4AE-U-I	CPX-4AE-I
Type				
Galvanic isolation	Channel – channel	No		
	Channel – internal bus	Yes, with external sensor supply		
LED indicators	Group diagnostics	1		
	Channel diagnostics	Via flashing frequency of group diagnostics	4	Via flashing frequency of group diagnostics
Diagnostics	Wire break per channel			
	Limit value violation per channel			
	Parameterisation error			
	Short circuit input signal	Overload at input	Short circuit input signal	
	–	Overflow/underflow	–	
	–	Short circuit in sensor supply	–	
Parameterisation	Data format			
	Forcing per channel			
	Limit value monitoring per channel			
	Measured value smoothing			
	Signal range per channel			
	Monitoring wire break per channel			
	Behaviour after short circuit			
	–	Behaviour after overload at input	–	
	–	Sensor supply active	–	
	Degree of protection to EN 60529			
Depending on connection block				
Temperature range	Operation	[°C]	–5 ... +50	
	Storage/transport	[°C]	–20 ... +70	
Materials	Reinforced PA, PC			
Note on materials	–	RoHS-compliant	–	
LABS (PWIS) conformity	VDMA24364-B2-L	VDMA24364-B2-L	VDMA24364-B2-L	
Grid dimension	[mm]	50		
Dimensions (including interlinking block and connection block) W x L x H	[mm]	50 x 107 x 50		
Product weight	[g]	48	46	47

Datasheet – Input module, analogue

Connection and display components

CPX-2AE-U-I and CPX-4AE-I

CPX-4AE-U-I

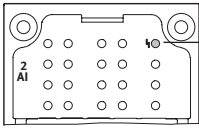

[1] Error LED (red; module error)

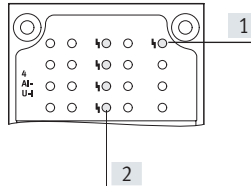

[1] Error LED (red; module error)
[2] Channel-related error LEDs (red)

Combinations of connection blocks and analogue module

Connection blocks	Part no.	Analogue module		
		CPX-2AE-U-I	CPX-4AE-U-I	CPX-4AE-I
CPX-AB-4-M12X2-5POL	195704	■	■	■
CPX-AB-4-M12X2-5POL-R	541254	■	■	■
CPX-AB-8-KL-4POL	195708	■	■	■
CPX-AB-1-SUB-BU-25POL	525676	■	■	■
CPX-M-AB-4-M12X2-5POL	549367	■	■	■

Pin assignment

Connection block inputs	CPX-2AE-U-I	CPX-4AE-U-I	CPX-4AE-I
CPX-AB-4-M12X2-5POL, CPX-AB-4-M12X2-5POL-R¹⁾ and CPX-M-AB-4-M12X2-5POL			
	X1.1: 24 V _{SEN}	X3.1: 24 V _{SEN}	X1.1: 24 V _{SEN}
	X1.2: Input U0+	X3.2: Input U1+	X1.2: Input 0+
	X1.3: 0 V _{SEN}	X3.3: 0 V _{SEN}	X1.3: 0 V _{SEN}
	X1.4: Input U0-	X3.4: Input U1-	X1.4: Input 0-
	X1.5: FE ²⁾	X3.5: FE ²⁾	X1.5: FE ²⁾
	X2.1: 24 V _{SEN}	X4.1: 24 V _{SEN}	X2.1: 24 V _{SEN}
	X2.2: Input I0+	X4.2: Input I1+	X2.2: Input 1+
	X2.3: 0 V _{SEN}	X4.3: 0 V _{SEN}	X2.3: 0 V _{SEN}
	X2.4: Input I0-	X4.4: Input I1-	X2.4: Input 1-
	X2.5: FE ²⁾	X4.5: FE ²⁾	X2.5: FE ²⁾
CPX-AB-8-KL-4POL			
	X1.0: 24 V _{SEN}	X5.0: 24 V _{SEN}	X1.0: 24 V _{SEN}
	X1.1: 0 V _{SEN}	X5.1: 0 V _{SEN}	X1.1: 0 V _{SEN}
	X1.2: Input U0-	X5.2: Input U1-	X1.2: Input 0-
	X1.3: FE	X5.3: FE	X1.3: FE
	X2.0: n.c.	X6.0: n.c.	X2.0: n.c.
	X2.1: n.c.	X6.1: n.c.	X2.1: n.c.
	X2.2: Input U0+	X6.2: Input U1+	X2.2: Input 0+
	X2.3: FE	X6.3: FE	X2.3: FE
	X3.0: 24 V _{SEN}	X7.0: 24 V _{SEN}	X3.0: 24 V _{SEN}
	X3.1: 0 V _{SEN}	X7.1: 0 V _{SEN}	X3.1: 0 V _{SEN}
	X3.2: Input I0-	X7.2: Input I1-	X3.2: Input 1-
	X3.3: FE	X7.3: FE	X3.3: FE
	X4.0: n.c.	X8.0: n.c.	X4.0: n.c.
	X4.1: n.c.	X8.1: n.c.	X4.1: n.c.
	X4.2: Input I0+	X8.2: Input I1+	X4.2: Input 1+
X4.3: FE	X8.3: FE	X4.3: FE	



1) Speedcon quick lock, additional shielding on metal thread
2) FE/shield additionally on metal thread

Datasheet – Input module, analogue

Pin assignment		CPX-2AE-U-I		CPX-4AE-U-I		CPX-4AE-I		
Connection block inputs		CPX-2AE-U-I		CPX-4AE-U-I		CPX-4AE-I		
CPX-AB-1-SUB-BU-25POL								
	1:	Input U0–	14:	Input U1–	1:	Input 0–	14:	Input 2–
	2:	Input U0+	15:	Input U1+	2:	Input 0+	15:	Input 2+
	3:	Input I0–	16:	Input I1–	3:	Input 1–	16:	Input 3–
	4:	Input I1+	17:	Input I1+	4:	Input 1+	17:	Input 3+
	5:	n.c.	18:	24 V _{SEN}	5:	n.c.	18:	24 V _{SEN}
	6:	n.c.	19:	n.c.	6:	n.c.	19:	n.c.
	7:	n.c.	20:	24 V _{SEN}	7:	n.c.	20:	24 V _{SEN}
	8:	n.c.	21:	n.c.	8:	n.c.	21:	n.c.
	9:	24 V _{SEN}	22:	0 V _{SEN}	9:	24 V _{SEN}	22:	0 V _{SEN}
	10:	24 V _{SEN}	23:	0 V _{SEN}	10:	24 V _{SEN}	23:	0 V _{SEN}
	11:	0 V _{SEN}	24:	0 V _{SEN}	11:	0 V _{SEN}	24:	0 V _{SEN}
	12:	0 V _{SEN}	25:	FE	12:	0 V _{SEN}	25:	FE
	13:	Shielding1)	Housing:	FE	13:	Shielding1)	Housing:	FE

1) Connect shield to functional earth FE

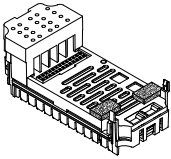
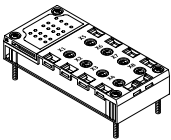
Datasheet – Input module, analogue

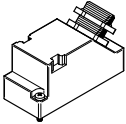
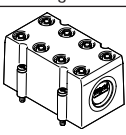
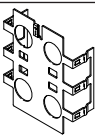
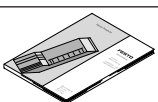
Ordering data		Part no.	Type	
Input module, analogue				
	2 analogue current or voltage inputs	526168	CPX-2AE-U-I	
	4 analogue current or voltage inputs	573710	CPX-4AE-U-I	
	4 analogue current inputs	541484	CPX-4AE-I	
Connection block				
	Polymer	4x socket M12, 5-pin	195704	CPX-AB-4-M12X2-5POL
		4x socket, M12 with quick-lock technology, 5-pin	541254	CPX-AB-4-M12X2-5POL-R
		Spring-loaded terminal, 32-pin	195708	CPX-AB-8-KL-4POL
		1x socket, Sub-D, 25-pin	525676	CPX-AB-1-SUB-BU-25POL
	Metal	4x socket M12, 5-pin	549367	CPX-M-AB-4-M12X2-5POL
Plug				
	M12, 5-pin	For cable Ø 2.1 ... 7 mm	8162296	NECB-S-M12G5-C2
	Sub-D plug, 25-pin		527522	SD-SUB-D-ST25
Covering				
	Covering hood for CPX-AB-8-KL-4POL (IP65, IP67)		538219	AK-8KL
	<ul style="list-style-type: none"> 8 cable through-feeds M9 1 cable through-feed for multi-pin plug 			
	Fittings kit		538220	VG-K-M9
Screening plate				
	Screening plate for M12 connections		526184	CPX-AB-S-4-M12
User documentation				
	User documentation	German	526415	CPX_AA/-_AE-DE
		English	526416	CPX_AA/-_AE-EN

Datasheet – Input module, analogue, with pressure sensors

Function

With the pressure input modules, a maximum of 4 pressures can be processed. The internal measured value of the sensor (analogue value with 10-bit resolution) is converted into an internal numerical format as appropriate to the parameterisation and made available to the bus node as a process image. It is also possible to combine 2 channels in each case to form a differential pressure channel.

Area of application

- Measuring range: 0 ... 10 bar or –1 ... +1 bar
- Choice of units of measurement
- Processing a maximum of 4 pressures per module
- Pressure indication via LCD display
- Direct connection via QS4 push-in connectors
- Error message via CPX
- Channel-oriented diagnostics

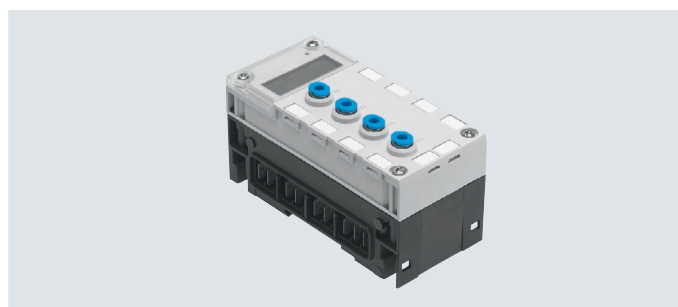

General technical data			CPX-4AE-P-B2	CPX-4AE-P-D10
Type				
Number of analogue inputs			4	
Pneumatic connection			QS-4	
Nominal operating voltage	[V DC]		24	
Operating voltage range	[V DC]		18 ... 30	
Intrinsic current consumption	[mA]		Typically 50	
Measured variable			4x relative or 2x differential pressure measurement	
Displayable units			<ul style="list-style-type: none"> • kPa • mbar • psi 	
Pressure measuring range	Start value	[bar]	–1	0
	End value	[bar]	1	10
Internal cycle time	[ms]		5	
Data format			<ul style="list-style-type: none"> • 15 bits + prefix • Binary notation in mbar, kPa, psi 	
LED indicators			Group diagnostics	
Diagnostics			<ul style="list-style-type: none"> • Limit value violation per channel • Parameterisation error • Sensor limit per channel 	
Parameterisation			<ul style="list-style-type: none"> • Diagnostics delay per channel • Hysteresis per module • Unit of measurement • Measured value smoothing per channel • Limit value monitoring per channel • Sensor limit per channel • Measurement of relative/differential pressure 	
Degree of protection to EN 60529			IP65, IP67	
Operating medium			Compressed air to ISO 8573-1:2010 [7:4:4]	
Note on the operating/pilot medium			Lubricated operation possible (in which case lubricated operation will always be required)	
Ambient temperature	[°C]		–5 ... 50	
Storage temperature	[°C]		–20 ... 70	
Temperature of medium	[°C]		0 ... 50	
Materials			Reinforced PA, PC	
Note on materials			RoHS-compliant	
LABS (PWIS) conformity			VDMA24364-B2-L	
Grid dimension	[mm]		50	
Dimensions (including interlinking block) W x L x H	[mm]		50 x 107 x 55	
Product weight	[g]		115	

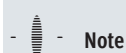

Note

Extreme pneumatic conditions, e.g. high cycle rate with high pressure amplitudes, can damage the sensors.

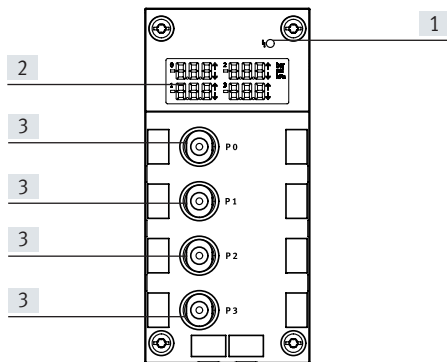

Datasheet – Input module, analogue, with pressure sensors

Connection and display components

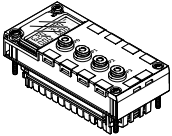
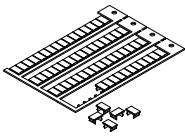

- [1] Error LED (red; module error)
- [2] LCD display with permanent display of the four measured pressures, unit of measurement and if applicable limit value violation
- [3] QS connections

Ordering data

Designation		Part no.	Type
Input module, analogue			
	4 analogue pressure inputs, pressure range -1 ... +1 bar	560361	CPX-4AE-P-B2
	4 analogue pressure inputs, pressure range 0 ... 10 bar	560362	CPX-4AE-P-D10
Inscription labels			
	Inscription labels 6x10 mm, 64 pieces, in a frame	18576	IBS-6x10
User documentation			
	User documentation	German	526415 CPX-AA/-_AE-DE
		English	526416 CPX-AA/-_AE-EN

Datasheet – Input module, analogue, for temperature inputs

Function

The CPX-PT100 analogue input module with 4 channels for temperature measurement enables the connection of up to 4 temperature sensors of the type PT100-PT1000, Ni100-Ni1000, etc. The temperature module supports various connection concepts with different numbers of sockets or terminals as appropriate to the connection block selected.

Area of application

- Temperature module for temperature sensors PT100, PT200, PT500, PT1000, Ni100, Ni120, Ni500, Ni1000
- Supports connection blocks with M12 and terminal connection
- Temperature module features can be parameterised
- 2-conductor, 3-conductor and 4-conductor connection
- The temperature module is provided with voltage supply for the electronics and the sensors via the inter-linking block
- Temperature module protection and diagnostics through integrated electronic fuse

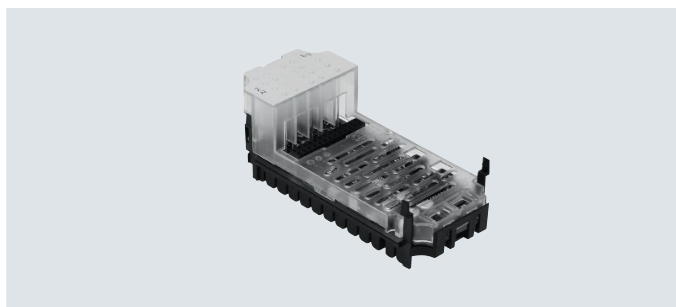

General technical data			CPX-4AE-T
Type			Temperature input
Number of analogue inputs			Choice of 2 or 4
Max. power supply per module		[A]	0.7
Fuse protection			Internal electronic fuse for sensor supply
Current consumption from 24 V sensor supply (quiescent current)		[mA]	Typically 50
Supply voltage for sensors		[V DC]	24 ±25%
Sensor type (parameterisable for each channel with DIL switch)			PT100, PT200, PT500, PT1000 Ni100, Ni120, Ni500, Ni1000
Temperature range	Pt standard	[°C]	–200 ... +850
	Pt climate	[°C]	–120 ... +130
	Ni	[°C]	–60 ... +180
Sensor connection technology			2-, 3- and 4-conductor technology
Resolution			15 bits + prefix
Operating error limit related to input range		[%]	±0.06
Basic error limit (25 °C)	Standard	[K]	±0.6
	Pt climate	[K]	±0.2
Temperature error relative to input range		[%]	±0.001
Linearity error (no software scaling)		[%]	±0.02
Repetition accuracy (at 25 °C)		[%]	±0.05
Max. line resistance per conductor		[Ω]	10
Max. permissible input voltage		[V]	±30
Cycle time (module)		[ms]	≤ 250

Datasheet – Input module, analogue, for temperature inputs

General technical data			
Data format			15 bits + prefix, complement of two, binary notation in tenths of a degree
Cable length		[m]	Max. 200 (shielded)
Galvanic isolation	Channel – channel		No
	Channel – internal bus		Yes
LED indicators	Group diagnostics		1
	Channel diagnostics		4
Diagnostics			<ul style="list-style-type: none"> • Short circuit/overload, channel • Parameterisation error • Value falling below nominal range/scaling end value • Value exceeding nominal range/full-scale value • Wire break
Parameterisation			<ul style="list-style-type: none"> • Unit of measurement and interference frequency suppression • Diagnostic message in the event of a wire break or short circuit • Limit monitoring per channel • Sensor connection technology • Sensor type/temperature coefficient, temperature range • Limit value per channel • Measured value smoothing
Degree of protection to EN 60529			Depending on connection block
Temperature range	Operation	[°C]	-5 ... +50
	Storage/transport	[°C]	-20 ... +70
Materials			Reinforced PA, PC
LABS (PWIS) conformity			VDMA24364-B2-L
Grid dimension		[mm]	50
Dimensions (including interlinking block and connection block) W x L x H		[mm]	50 x 107 x 50
Product weight		[g]	47

Connection and display components

CPX-4AE-T

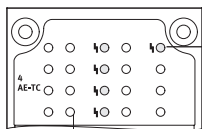

- [1] Error LED (red; module error)
 [2] Channel-related error LEDs (red)

Combinations of connection blocks and analogue module

Connection blocks	Part no.	Temperature module
		CPX-4AE-T
CPX-AB-4-M12X2-5POL	195704	■
CPX-AB-4-M12X2-5POL-R	541254	■
CPX-AB-8-KL-4POL	195708	■
CPX-M-AB-4-M12X2-5POL	549367	■



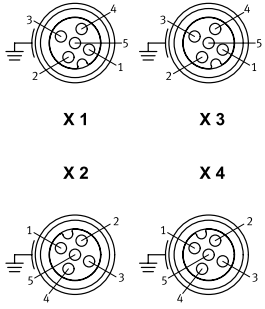
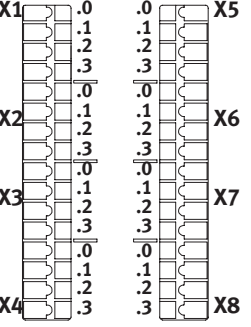

Datasheet – Input module, analogue, for temperature inputs

Pin assignment		CPX-4AE-T
Connection block inputs		
CPX-AB-4-M12X2-5POL, CPX-AB-4-M12X2-5POL-R¹⁾ and CPX-M-AB-4-M12X2-5POL		
 <p>X 1 X 3</p> <p>X 2 X 4</p>	<p>X1.1: Input I0+</p> <p>X1.2: Input U0+</p> <p>X1.3: Input I0-</p> <p>X1.4: Input U0-</p> <p>X1.5: FE²⁾</p> <p>X2.1: Input I1+</p> <p>X2.2: Input U1+</p> <p>X2.3: Input I1-</p> <p>X2.4: Input U1-</p> <p>X2.5: FE²⁾</p>	<p>X3.1: Input I2+</p> <p>X3.2: Input U2+</p> <p>X3.3: Input I2-</p> <p>X3.4: Input U2-</p> <p>X3.5: FE²⁾</p> <p>X4.1: Input I3+</p> <p>X4.2: Input U3+</p> <p>X4.3: Input I3-</p> <p>X4.4: Input U3-</p> <p>X4.5: FE²⁾</p>
CPX-AB-8-KL-4POL		
 <p>X1 .0 .0 X5</p> <p> .1 .1 </p> <p> .2 .2 </p> <p> .3 .3 </p> <p>X2 .0 .0 X6</p> <p> .1 .1 </p> <p> .2 .2 </p> <p> .3 .3 </p> <p>X3 .0 .0 X7</p> <p> .1 .1 </p> <p> .2 .2 </p> <p> .3 .3 </p> <p>X4 .0 .0 X8</p> <p> .1 .1 </p> <p> .2 .2 </p> <p> .3 .3 </p>	<p>X1.0: Input I0+</p> <p>X1.1: Input I0-</p> <p>X1.2: Input U0-</p> <p>X1.3: FE</p> <p>X2.0: n.c.</p> <p>X2.1: n.c.</p> <p>X2.2: Input U0+</p> <p>X2.3: FE</p> <p>X3.0: Input I1+</p> <p>X3.1: Input I1-</p> <p>X3.2: Input U1-</p> <p>X3.3: FE</p> <p>X4.0: n.c.</p> <p>X4.1: n.c.</p> <p>X4.2: Input U1+</p> <p>X4.3: FE</p>	<p>X5.0: Input I2+</p> <p>X5.1: Input I2-</p> <p>X5.2: Input U2-</p> <p>X5.3: FE</p> <p>X6.0: n.c.</p> <p>X6.1: n.c.</p> <p>X6.2: Input U12+</p> <p>X6.3: FE</p> <p>X7.0: Input I3+</p> <p>X7.1: Input I3-</p> <p>X7.2: Input U3-</p> <p>X7.3: FE</p> <p>X8.0: n.c.</p> <p>X8.1: n.c.</p> <p>X8.2: Input U3+</p> <p>X8.3: FE</p>

1) Speedcon quick lock, additional shielding on metal thread

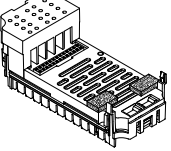
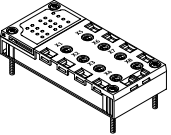
2) FE/shield additionally on metal thread

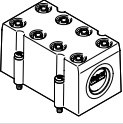
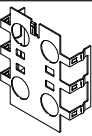
Datasheet – Input module, analogue, for temperature inputs

Ordering data		Part no.	Type	
Designation				
Input module, analogue				
	2 or 4 analogue temperature inputs	541486	CPX-4AE-T	
Connection block				
	Polymer	4x socket M12, 5-pin	195704	CPX-AB-4-M12X2-5POL
		4x socket, M12 with quick-lock technology, 5-pin	541254	CPX-AB-4-M12X2-5POL-R
		Spring-loaded terminal, 32-pin	195708	CPX-AB-8-KL-4POL
	Metal	4x socket M12, 5-pin	549367	CPX-M-AB-4-M12X2-5POL
Plug				
	M12, 5-pin	For cable Ø 2.1 ... 7 mm	8162296	NECB-S-M12G5-C2
Covering				
	Covering hood for CPX-AB-8-KL-4POL (IP65, IP67)		538219	AK-8KL
	<ul style="list-style-type: none"> • 8 cable through-feeds M9 • 1 cable through-feed for multi-pin plug 			
	Fittings kit		538220	VG-K-M9
Screening plate				
	Screening plate for M12 connections		526184	CPX-AB-S-4-M12
User documentation				
	User documentation	German	526415	CPX-AA/-_AE-DE
		English	526416	CPX-AA/-_AE-EN

Datasheet – Input module, analogue, for thermocouple

Function

The CPX-4AE-TC analogue input module with 4 channels for temperature measurement enables up to 4 thermocouple sensors to be connected.

The channels feature wire break and short circuit detection.

If no cold junction compensation sensor is being used, an internal theoretical value of 25 °C can be used (accuracy is impaired).

Area of application

- Supports connection blocks with M12 and terminal connection
- Temperature module features can be parameterised
- 2-conductor connection
- 2-conductor connection for a PT1000 sensor for cold junction compensation
- The temperature module is provided with voltage supply for the electronics and the sensors via the inter-linking block
- Temperature module protection and diagnostics through integrated electronic fuse

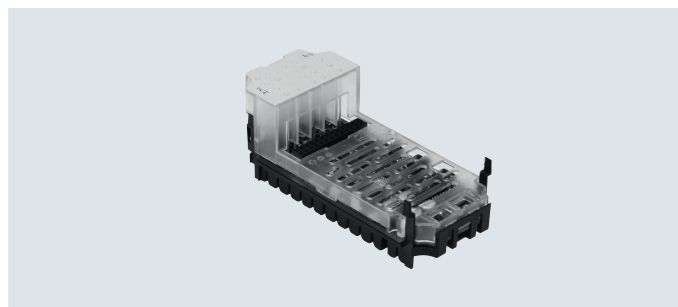

General technical data		CPX-4AE-TC
Type		Temperature input
Number of analogue inputs		4
Fuse protection (short circuit)		Internal electronic fuse per channel
Nominal operating voltage	[V DC]	24
Operating voltage range	[V DC]	18 ... 30
Sensor type (parameterisable for each channel with software)		<ul style="list-style-type: none"> • Type B +400 ... +1820 °C, 8 μV/°C • Type E –270 ... +900 °C, 60 μV/°C • Type J –200 ... +1200 °C, 51 μV/°C • Type K –200 ... +1370 °C, 40 μV/°C • Type N –200 ... +1300 °C, 38 μV/°C • Type R 0 ... +1760 °C, 12 μV/°C • Type S 0 ... +1760 °C, 11 μV/°C • Type T –200 ... +400 °C, 40 μV/°C
Sensor connection technology		2-conductor technology
Operating error limit related to ambient temperature	[%]	Max. \pm 0.6
Basic error limit (at 25 °C)	[%]	Max. \pm 0.4
Repetition accuracy (at 25 °C)	[%]	\pm 0.05
Max. line resistance per conductor	[Ω]	10
Max. total current per module	[mA]	30
Max. permissible input voltage	[V]	\pm 30
Internal cycle time (module)	[ms]	250

Datasheet – Input module, analogue, for thermocouple

General technical data		
Data format		<ul style="list-style-type: none"> • 15 bits + prefix, complement of two • Binary notation in tenths of a degree
Cable length	[m]	Max. 50 (shielded)
Galvanic isolation	Channel – channel	No
	Channel – internal bus	Yes
LED indicators	Group diagnostics	1
	Channel diagnostics	4
Diagnostics		<ul style="list-style-type: none"> • Parameterisation error • Wire break per channel • Limit value violation per channel
Parameterisation		<ul style="list-style-type: none"> • Monitoring wire break per channel • Unit of measurement • Cold-junction compensation • Sensor type per channel • Limit value monitoring per channel • Measured value smoothing
Degree of protection to EN 60529		Depending on connection block
Temperature range	Operation [°C]	-5 ... +50
	Storage/transport [°C]	-20 ... +70
Materials		Reinforced PA, PC
LABS (PWIS) conformity		VDMA24364-B2-L
Grid dimension	[mm]	50
Dimensions (including interlinking block and connection block) W x L x H	[mm]	50 x 107 x 50
Product weight	[g]	46

Connection and display components

CPX-4AE-TC

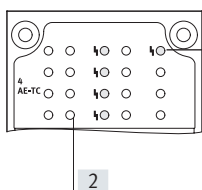

- [1] Error LED (red; module error)
- [2] Channel-related error LEDs (red)

Combinations of connection blocks and analogue module

Connection blocks	Part no.	Temperature module
		CPX-4AE-TC
CPX-AB-4-M12X2-5POL	195704	■
CPX-AB-4-M12X2-5POL-R	541254	■
CPX-AB-8-KL-4POL	195708	■
CPX-M-AB-4-M12X2-5POL	549367	■

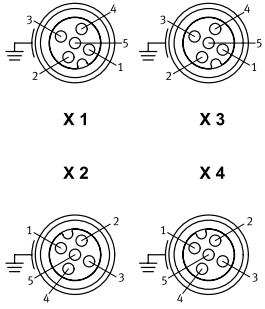
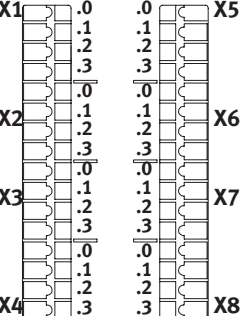

Datasheet – Input module, analogue, for thermocouple

Pin assignment		CPX-4AE-TC
Connection block inputs		
CPX-AB-4-M12X2-5POL, CPX-AB-4-M12X2-5POL-R¹⁾ and CPX-M-AB-4-M12X2-5POL		
	<p>X1.1: Cold junction compensation 0+</p> <p>X1.2: Input signal U0+</p> <p>X1.3: Cold junction compensation 0-</p> <p>X1.4: Input signal U0-</p> <p>X1.5: FE²⁾</p> <p>X2.1: Cold junction compensation 1+</p> <p>X2.2: Input signal U1+</p> <p>X2.3: Cold junction compensation 1-</p> <p>X2.4: Input signal U1-</p> <p>X2.5: FE²⁾</p>	<p>X3.1: Cold junction compensation 2+</p> <p>X3.2: Input signal U2+</p> <p>X3.3: Cold junction compensation 2-</p> <p>X3.4: Input signal U2-</p> <p>X3.5: FE²⁾</p> <p>X4.1: Cold junction compensation 3+</p> <p>X4.2: Input signal U3+</p> <p>X4.3: Cold junction compensation 3-</p> <p>X4.4: Input signal U3-</p> <p>X4.5: FE²⁾</p>
CPX-AB-8-KL-4POL		
	<p>X1.0: Cold junction compensation 0+</p> <p>X1.1: Cold junction compensation 0-</p> <p>X1.2: Input signal U0-</p> <p>X1.3: FE</p> <p>X2.0: n.c.</p> <p>X2.1: n.c.</p> <p>X2.2: Input signal U0+</p> <p>X2.3: FE</p> <p>X3.0: Cold junction compensation 1+</p> <p>X3.1: Cold junction compensation 1-</p> <p>X3.2: Input signal U1-</p> <p>X3.3: FE</p> <p>X4.0: n.c.</p> <p>X4.1: n.c.</p> <p>X4.2: Input signal U1+</p> <p>X4.3: FE</p>	<p>X5.0: Cold junction compensation 2+</p> <p>X5.1: Cold junction compensation 2-</p> <p>X5.2: Input signal U2-</p> <p>X5.3: FE</p> <p>X6.0: n.c.</p> <p>X6.1: n.c.</p> <p>X6.2: Input signal U2+</p> <p>X6.3: FE</p> <p>X7.0: Cold junction compensation 3+</p> <p>X7.1: Cold junction compensation 3-</p> <p>X7.2: Input signal U3-</p> <p>X7.3: FE</p> <p>X8.0: n.c.</p> <p>X8.1: n.c.</p> <p>X8.2: Input signal U3+</p> <p>X8.3: FE</p>

1) Speedcon quick lock, additional shielding on metal thread

2) FE/shield additionally on metal thread

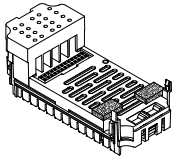
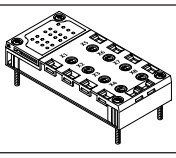
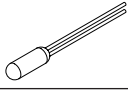
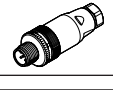
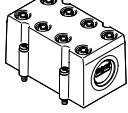
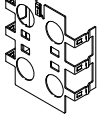
Datasheet – Input module, analogue, for thermocouple

Ordering data		Part no.	Type
Designation			
Input module, analogue			
	4 analogue temperature inputs, with 2-conductor connection for a PT1000 sensor for cold junction compensation	553594	CPX-4AE-TC
Connection block			
	Polymer	4x socket M12, 5-pin	195704 CPX-AB-4-M12X2-5POL
		4x socket, M12 with quick-lock technology, 5-pin	541254 CPX-AB-4-M12X2-5POL-R
		Spring-loaded terminal, 32-pin	195708 CPX-AB-8-KL-4POL
	Metal	4x socket M12, 5-pin	549367 CPX-M-AB-4-M12X2-5POL
Cold junction compensation			
	PT1000 temperature sensor for cold junction compensation	553596	CPX-W-PT1000
Plug			
	M12, 5-pin	For cable Ø 2.1 ... 7 mm	8162296 NECB-S-M12G5-C2
Covering			
	Covering hood for CPX-AB-8-KL-4POL (IP65, IP67)	538219	AK-8KL
	<ul style="list-style-type: none"> • 8 cable through-feeds M9 • 1 cable through-feed for multi-pin plug Fittings kit	538220	VG-K-M9
Screening plate			
	Screening plate for M12 connections	526184	CPX-AB-S-4-M12
User documentation			
	User documentation	German	526415 CPX-AA/-_AE-DE
		English	526416 CPX-AA/-_AE-EN

Datasheet – Output module, analogue

Function

Analogue modules are used to control devices with a standard analogue interface such as proportional valves, etc.

Depending on the connection block selected, the analogue module supports various connection concepts with different numbers of sockets or terminals.

Area of application

- Analogue module for 0 ... 10 V, 0 ... 20 mA or 4 ... 20 mA
- Supports connection blocks with Sub-D, terminal connection and M12 connection
- Analogue module features can be parameterised
- Different data formats available
- Operation with and without galvanic isolation possible
- The analogue module receives the voltage supply for the electronics and the actuators from the inter-linking block
- Analogue module protection and diagnostics through integrated electronic fuse

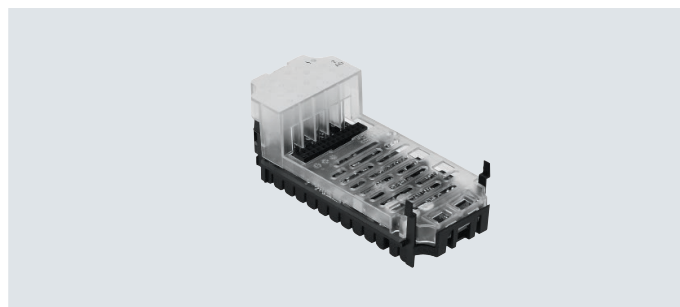

General technical data			
Type		CPX-2AA-U-I	
		Voltage output	Current output
Number of analogue outputs		2	
Max. actuator supply per module [A]		2.8	
Fuse protection		Internal electronic fuse for actuator supply	
Current consumption from 24 V sensor supply (at full load) [mA]		Max. 150	
Current consumption from 24 V actuator supply (at full load) [A]		4 ... 10	
Supply voltage for actuators [V DC]		24 ±25%	
Signal range (parameterisable for each channel with DIL switch or software)		0 ... 10 V DC	0 ... 20 mA 4 ... 20 mA
Resolution [bit]		12	
Number of units		4096	
Absolute accuracy [%]		±0.6	
Linearity error (no software scaling) [%]		±0.1	
Repetition accuracy (at 25 °C) [%]		0.05	
Encoder selection	Load resistance for ohmic load [kΩ]	Min. 1	Max. 0.5
	Load resistance for capacitive load [μF]	Max. 1	–
	Load resistance for inductive load [mH]	–	Max. 1
	Short-circuit protection analogue output	Yes	–
	Short-circuit current of analogue output [mA]	Approx. 20	–
	Open circuit voltage [V DC]	–	18
	Destruction limit against externally applied voltage [V DC]	15	
	Actuator connection	2 conductors	
Cycle time (module) [ms]		≤ 4	

Datasheet – Output module, analogue

General technical data			CPX-2AA-U-I	
Type			Voltage output	Current output
Settling time	For ohmic load	[ms]	0.1	0.1
	For capacitive load	[ms]	0.7	–
	For inductive load	[ms]	–	0.5
Data format	15 bits + prefix, linear scaling 12 bits right-justified 12 bits left-justified, S7 compatible 12 bits left-justified, S5 compatible			
Cable length	[m]	Max. 30 (shielded)		
LED indicators	Group diagnostics	1		
	Channel diagnostics	Yes, via flashing frequency of group diagnostics		
Diagnostics	<ul style="list-style-type: none"> • Short circuit/overload, actuator supply • Parameterisation error • Value falling below nominal range/scaling end value • Value exceeding nominal range/full-scale value • Wire break 			
Parameterisation	<ul style="list-style-type: none"> • Short circuit monitoring, actuator supply • Short circuit monitoring, analogue output • Behaviour after short circuit in actuator supply • Data format • Lower limit value/full-scale value • Upper limit value/full-scale value • Monitoring value falling below nominal range/full-scale value • Monitoring value exceeding nominal range/full-scale value • Monitoring wire break • Signal range 			
Degree of protection to EN 60529	Depending on connection block			
Temperature range	Operation	[°C]	–5 ... +50	
	Storage/transport	[°C]	–20 ... +70	
Materials	Reinforced PA, PC			
LABS (PWIS) conformity	VDMA24364-B2-L			
Grid dimension	[mm]	50		
Dimensions (including interlinking block and connection block) W x L x H	[mm]	50 x 107 x 50		
Product weight	[g]	49		

Connection and display components

CPX-2AA-U-I

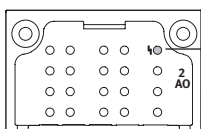

[1] Error LED (red; module error)

Combinations of connection blocks and analogue module

Connection blocks	Part no.	Analogue module
		CPX-2AA-U-I
CPX-AB-4-M12X2-5POL	195704	■
CPX-AB-4-M12X2-5POL-R	541254	■
CPX-AB-8-KL-4POL	195708	■
CPX-AB-1-SUB-BU-25POL	525676	■
CPX-M-AB-4-M12X2-5POL	549367	■

Datasheet – Output module, analogue

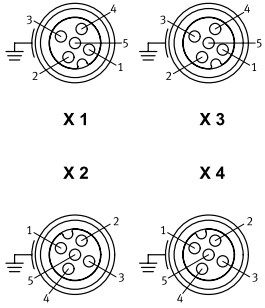
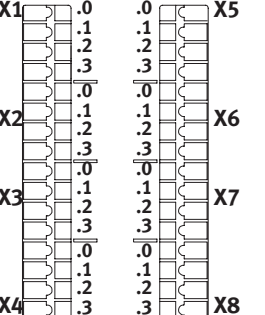
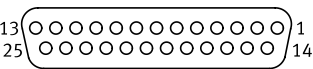

Pin assignment		CPX-2AA-U-I
Connection block outputs		
CPX-AB-4-M12X2-5POL, CPX-AB-4-M12X2-5POL-R¹⁾, CPX-M-AB-4-M12X2-5POL		
	X1.1: 24 V _{OUT} X1.2: Output U0+ X1.3: 0 V _{OUT} X1.4: Output GND X1.5: FE ²⁾ X2.1: 24 V _{OUT} X2.2: Output I0+ X2.3: 0 V _{OUT} X2.4: Output GND X2.5: FE ²⁾	X3.1: 24 V _{OUT} X3.2: Output U1+ X3.3: 0 V _{OUT} X3.4: Output GND X3.5: FE ²⁾ X4.1: 24 V _{OUT} X4.2: Output I1+ X4.3: 0 V _{OUT} X4.4: Output GND X4.5: FE ²⁾
CPX-AB-8-KL-4POL		
	X1.0: 24 V _{OUT} X1.1: 0 V _{OUT} X1.2: Output GND X1.3: FE X2.0: n.c. X2.1: n.c. X2.2: Output U0+ X2.3: FE X3.0: 24 V _{OUT} X3.1: 0 V _{OUT} X3.2: Output GDN X3.3: FE X4.0: n.c. X4.1: n.c. X4.2: Output I0+ X4.3: FE	X5.0: 24 V _{OUT} X5.1: 0 V _{OUT} X5.2: Output GND X5.3: FE X6.0: n.c. X6.1: n.c. X6.2: Output U1+ X6.3: FE X7.0: 24 V _{OUT} X7.1: 0 V _{OUT} X7.2: Output GND X7.3: FE X8.0: n.c. X8.1: n.c. X8.2: Output I1+ X8.3: FE
CPX-AB-1-SUB-BU-25POL		
	1: Output GND 2: Output U0+ 3: Output GND 4: Output I0+ 5: n.c. 6: n.c. 7: n.c. 8: n.c. 9: 24 V _{OUT} 10: 24 V _{OUT} 11: 0 V _{OUT} 12: 0 V _{OUT} 13: Shielding ³⁾	14: Output GND 15: Output U1+ 16: Output GND 17: Output I1+ 18: 24 V _{OUT} 19: n.c. 20: 24 V _{OUT} 21: n.c. 22: 0 V _{OUT} 23: 0 V _{OUT} 24: 0 V _{OUT} 25: FE Housing: FE

1) Speedcon quick lock, additional shielding on metal thread

2) FE/shield additionally on metal thread

3) Connect shield to functional earth FE

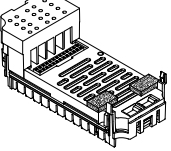
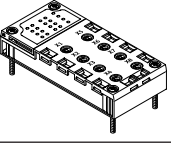
Datasheet – Output module, analogue

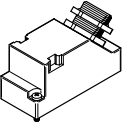
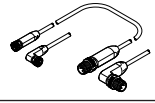
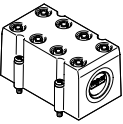
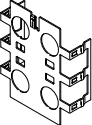
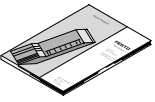
Ordering data		Part no.	Type
Designation			
Output module, analogue			
	2 analogue current or voltage outputs	526170	CPX-2AA-U-I
Connection block			
	Polymer	4x socket M12, 5-pin	195704 CPX-AB-4-M12X2-5POL
		4x socket, M12 with quick-lock technology, 5-pin	541254 CPX-AB-4-M12X2-5POL-R
		Spring-loaded terminal, 32-pin	195708 CPX-AB-8-KL-4POL
		1x socket, Sub-D, 25-pin	525676 CPX-AB-1-SUB-BU-25POL
	Metal	4x socket M12, 5-pin	549367 CPX-M-AB-4-M12X2-5POL
Plug			
	M12, 5-pin	For cable Ø 2.1 ... 7 mm	8162296 NECB-S-M12G5-C2
	Sub-D plug, 25-pin		527522 SD-SUB-D-ST25
Connecting cable			
	Modular system for a choice of connecting cables	–	NEBA-... → Internet: neba
Covering			
	Covering hood for CPX-AB-8-KL-4POL (IP65, IP67)	538219	AK-8KL
	<ul style="list-style-type: none"> • 8 cable through-feeds M9 • 1 cable through-feed for multi-pin plug Fittings kit	538220	VG-K-M9
Screening plate			
	Screening plate for M12 connections	526184	CPX-AB-S-4-M12
User documentation			
	User documentation	German	526415 CPX-AA/-_AE-DE
		English	526416 CPX-AA/-_AE-EN

Datasheet – PROFIsafe shut-off module

Function

The PROFIsafe shut-off module interrupts the contact rails of the interlinking block for valves and outputs. The supply voltage for valves can be switched by the module within the CPX terminal and via a connection block to two consuming devices. Actuation takes place via the bus node (PROFINET) of the CPX terminal.

Area of application

- Output module for 24 V DC supply voltage
- Shut-off module for supply voltage for valves
- Can only be used with PROFINET or PROFIBUS bus nodes
- The shut-off module is supplied with voltage for the electronics and the outputs by the interlinking block
- The outputs are powered from the power supply for valves (V_{Valves})

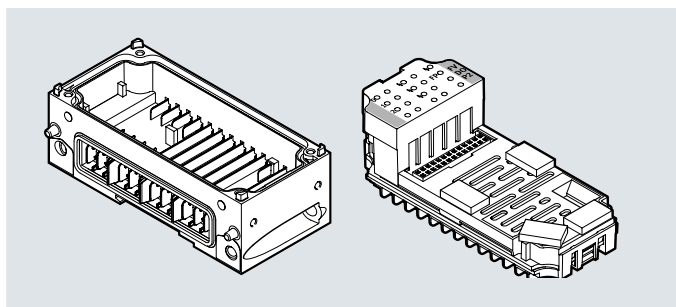

General technical data			CPX-FVDA-P2
Type			
Number of outputs			2
Note on outputs			1 internal channel for switching off the supply voltage for valves 2 external outputs
Maximum address volume	Inputs	[B]	6
	Outputs	[B]	6
Maximum cable length			[m] 200
Max. power supply	Per module	[A]	5
	Per channel	[A]	1.5
Fuse protection (short circuit)			Internal electronic fuse per channel
Current consumption of the module			[mA] Typ. 65 (power supply for valves)
			[mA] Typ. 25 (power supply for electronics)
Operating voltage	Nominal width	[V DC]	24
	Permissible range	[V DC]	20.4 ... 28.8
Voltage drop per channel			[V] 0.6
Residual ripple			[Vss] 2 within voltage range
Load capacity to FE			[nF] 400
Max. response time to switch-off command			[ms] 23
Galvanic isolation	Channel – channel	No	
	Channel – internal bus	Yes, with intermediate air supply	
Switching logic	Outputs	P-M switching	
Safety Integrity Level			Safe switch-off, SIL3
Performance Level			Safe switch-off/category 3, Performance Level e
Failure rate per hour (PFH)			1.0x 10 ⁻⁹
Certificate-issuing authority			German Technical Control Board (TÜV) Rhld 01/205/5294.02/23
			German Technical Control Board (TÜV) Rhld 01/205U/5294.01/23
LED indicators	Group diagnostics	1	
	Channel diagnostics	3	
	Channel status	3	
	Fail-safe protocol active	1	
Diagnostics			<ul style="list-style-type: none"> • Short circuit/overload per channel • Undervoltage of valves • Cross circuit • Wire break per channel
Parameterisation			<ul style="list-style-type: none"> • Monitoring wire break per channel • Diagnostic behaviour
Degree of protection to EN 60529			Dependent on the connection block
Grid dimension	[mm]	50	
Dimensions (including interlinking block and connection block) W x L x H	[mm]	50 x 107 x 55	
Product weight	[g]	50	

Datasheet – PROFIsafe shut-off module

Materials		
Housing		Reinforced PA, PC
Note on materials		RoHS-compliant
LABS (PWIS) conformity		VDMA24364-B2-L
Operating and environmental conditions		
Ambient temperature	[°C]	-5 ... +50
Storage temperature	[°C]	-20 ... +70
CE marking (see declaration of conformity) ¹⁾		To EU Machinery Directive
		To EU EMC Directive
		To EU RoHS Directive
UKCA marking (see declaration of conformity) ¹⁾		According to UK regulations for machines
		To UK EMC regulations
		To UK RoHS regulations
Certification		c UL us - Recognized (OL)

1) More information www.festo.com/catalogue/... → Support/Downloads.

Connection and display components

CPX-FVDA-P2

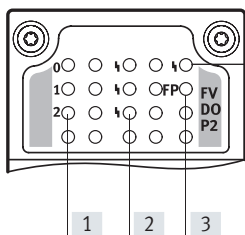

- [1] Status LEDs (yellow):
 0: Supply voltage for valves
 1: X1
 2: X2

- [2] Channel-related error LEDs (red)
 [3] Fail-safe protocol active (green)
 [4] Error LED (red; module error)

Combinations of bus nodes/control blocks to PROFIsafe switch-off module

Bus node/control block	Part no.	PROFIsafe shut-off module
		CPX-FVDA-P2
CPX-FB13	195740	■
CPX-FB43	8110369	■
CPX-M-FB44	8110370	■
CPX-M-FB45	8110371	■

 Note

The PROFIsafe shut-off module CPX-FVDA-P2 can only be integrated as of software release 21 or release 30 (in the case of CPX-FB13).

Datasheet – PROFIsafe shut-off module

Combinations of connection blocks for PROFIsafe disconnection module		
Connection blocks	Part no.	PROFIsafe shut-off module
		CPX-FVDA-P2
CPX-M-AB-4-M12X2-5POL	549367	■
CPX-AB-8-KL-4POL	195708	■

Pin assignment	
Connection block outputs	CPX-FVDA-P2

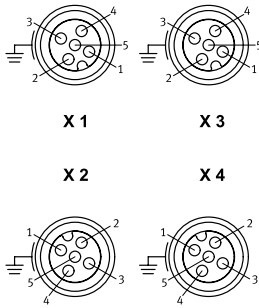
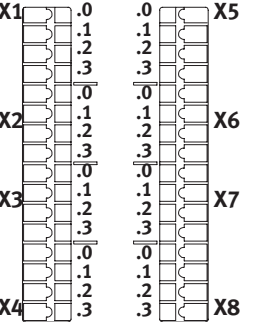
CPX-M-AB-4-M12X2-5POL		
	<p>X1.1: 0 V_{OUT} 1 (cannot be switched off)</p> <p>X1.2: 24 V_{OUT} 1 (cannot be switched off)</p> <p>X1.3: 0 V_{OUT} 1 (cannot be switched off)</p> <p>X1.4: 24 V_{OUT} 1 (cannot be switched off)</p> <p>X1.5: FE</p> <p>X2.1: 0 V_{OUT} 2 (cannot be switched off)</p> <p>X2.2: 24 V_{OUT} 2 (cannot be switched off)</p> <p>X2.3: 0 V_{OUT} 2 (can be switched off via fieldbus)</p> <p>X2.4: 24 V_{OUT} 2 (can be switched off via fieldbus)</p> <p>X2.5: FE</p>	<p>X3.1: n.c.</p> <p>X3.2: n.c.</p> <p>X3.3: n.c.</p> <p>X3.4: n.c.</p> <p>X3.5: FE</p> <p>X4.1: n.c.</p> <p>X4.2: n.c.</p> <p>X4.3: n.c.</p> <p>X4.4: n.c.</p> <p>X4.5: FE</p>
CPX-AB-8-KL-4POL		
	<p>X1.0: 0 V_{OUT} 1 (cannot be switched off)</p> <p>X1.1: 0 V_{OUT} 1 (can be switched off via fieldbus)</p> <p>X1.2: 24 V_{OUT} 1 (can be switched off via fieldbus)</p> <p>X1.3: FE</p> <p>X2.0: n.c.</p> <p>X2.1: n.c.</p> <p>X2.2: 24 V_{OUT} 1 (cannot be switched off)</p> <p>X2.3: FE</p> <p>X3.0: 0 V_{OUT} 2 (cannot be switched off)</p> <p>X3.1: 0 V_{OUT} 2 (can be switched off via fieldbus)</p> <p>X3.2: 24 V_{OUT} 2 (can be switched off via fieldbus)</p> <p>X3.3: FE</p> <p>X4.0: n.c.</p> <p>X4.1: n.c.</p> <p>X4.2: 24 V_{OUT} 2 (cannot be switched off)</p> <p>X4.3: FE</p>	<p>X5.0: n.c.</p> <p>X5.1: n.c.</p> <p>X5.2: n.c.</p> <p>X5.3: n.c.</p> <p>X6.0: n.c.</p> <p>X6.1: n.c.</p> <p>X6.2: n.c.</p> <p>X6.3: n.c.</p> <p>X7.0: n.c.</p> <p>X7.1: n.c.</p> <p>X7.2: n.c.</p> <p>X7.3: n.c.</p> <p>X8.0: n.c.</p> <p>X8.1: n.c.</p> <p>X8.2: n.c.</p> <p>X8.3: n.c.</p>

Datasheet – PROFIsafe shut-off module

Combinations of interlinking blocks and PROFIsafe shut-off module

Interlinking blocks	Part no.	PROFIsafe shut-off module
		CPX-FVDA-P2
CPX-GE-EV-S	195746	–
CPX-GE-EV-S-VL	8022170	–
CPX-GE-EV-S-7/8-4POL	541248	–
CPX-GE-EV-S-7/8-5POL	541244	–
CPX-GE-EV-S-7/8-5POL-VL	8022172	–
CPX-M-GE-EV-S-7/8-CIP-4P	568956	–
CPX-M-GE-EV-S-7/8-5POL	550208	–
CPX-M-GE-EV-S-7/8-5POL-VL	8022165	–
CPX-M-GE-EV-S-M12-5POL	8098392	–
CPX-M-GE-EV-S-PP-5POL	563057	–
CPX-GE-EV	195742	–
CPX-M-GE-EV	550206	–
CPX-M-GE-EV-FVO	567806	■
CPX-GE-EV-Z	195744	–
CPX-GE-EV-Z-7/8-4POL	541250	–
CPX-GE-EV-Z-7/8-5POL	541246	–
CPX-M-GE-EV-Z-7/8-5POL	550210	–
CPX-M-GE-EV-Z-PP-5POL	563058	–
CPX-GE-EV-V	533577	–
CPX-M-GE-EV-W-M12-5POL	8098391	–



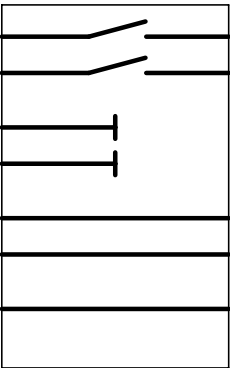

General technical data

Type	CPX-M-GE-EV-FVO	
Nominal operating voltage	[V DC]	24
Current carrying capacity (per contact/contact rail)	[A]	16
Degree of protection to EN 60529	Depending on connection block	
Ambient temperature	[°C]	–5 ... +50
Certification	c UL us - Recognized (OL)	
Materials	Die-cast aluminium	
Note on materials	RoHS-compliant	
LABS (PWIS) conformity	VDMA24364-B2-L	
Type of mounting	Angled fitting	
Grid dimension	[mm]	50
Dimensions W x L x H	[mm]	50 x 107 x 35
Product weight	[g]	170

Pin assignment

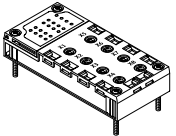
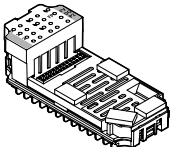
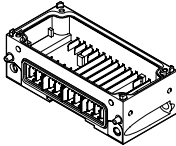
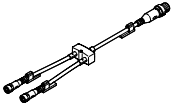
Wiring	Pin	Assignment
 <p>0V Valves 24V Valves 0V Output 24V Output 0V El./Sen. 24V El./Sen. FE</p>	–	–
	–	–
	–	–
	–	–
	–	–
	–	–
	–	–
	–	–
	–	–
	–	–

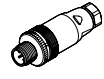
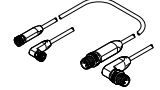
Datasheet – PROFIsafe shut-off module

Ordering data		Description	Part no.	Type
PROFIsafe shut-off module				
	Metal connection block	4x socket M12, 5-pin	549367	CPX-M-AB-4-M12X2-5POL
	Polymer connection block	Spring-loaded terminal, 32-pin	195708	CPX-AB-8-KL-4POL
	Electronics module (can only be used with CPX-M-GE-EV-FVO)	PROFINET, PROFIBUS	1971599	CPX-FVDA-P2
	Metal interlinking block (for CPX-FVDA-P2 only)		567806	CPX-M-GE-EV-FVO
Distributor				
	Modular system for all types of sensor/actuator distributor		–	NEDY-... → Internet: nedy
	1x plug M12, 4-pin	2x socket M12, 5-pin	8005310	NEDY-L2R1-V1-M12G5-N-M12G4
Plug				
	M12, 4-pin	For cable Ø 2.1 ... 7 mm	8162294	NECB-S-M12G4-C2
		For 2x cable Ø 2.1 ... 5.6 mm	8162295	NECB-S-M12G4-C2-D
	M12, 5-pin	For cable Ø 2.1 ... 7 mm	8162296	NECB-S-M12G5-C2
		For 2x cable Ø 2.1 ... 5.6 mm	8162297	NECB-S-M12G5-C2-D
Connecting cable				
	Modular system for a choice of connecting cables		–	NEBA-... → Internet: neba
User documentation				
	User documentation for PROFIsafe shut-off module		German	8022606 CPX-FVDA-P2-DE
			English	8022607 CPX-FVDA-P2-EN

Datasheet – End plate with system supply

Function

End plates form the outer edge of the CPX terminal.

The earthing connection and fixing holes for wall or DIN rail mounting are located on the left-hand end plate.

The end plate with system supply has contact rails from which the other CPX components on the interlinking modules are supplied with power.

Area of application

- 24 V DC supply voltage for the electronics of the CPX terminal
- 24 V DC supply voltage for inputs
- 24 V DC supply voltage for valves
- 24 V DC supply voltage for outputs

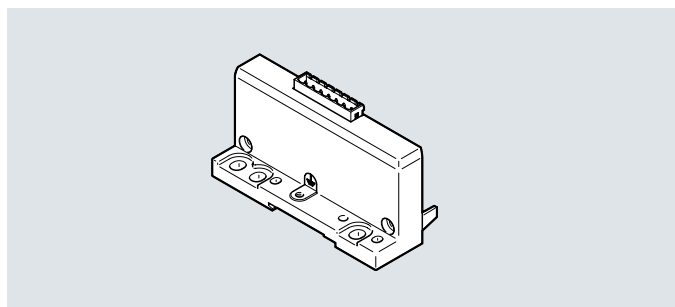

General technical data		
Electrical connection		Plug, 7-pin
Type of mounting		Tie rods
Power supply		System supply
Maximum power supply	[A]	12
Product weight	[g]	145

Materials	
Housing	Die-cast aluminium, painted
Note on materials	RoHS-compliant
LABS (PWIS) conformity	VDMA24364-B2-L

Operating and environmental conditions	
Certification	c UL us - Recognized (OL)

Pin assignment		
Wiring	Pin	Assignment
Plug, 7-pin		
	[1]	0 V power supply for valves
	[2]	24 V DC load voltage supply for valves
	[3]	0 V power supply for outputs
	[4]	24 V DC load voltage supply for outputs
	[5]	0 V power supply for electronics and sensors
	[6]	24 V DC supply voltage for electronics and sensors
	[7]	FE

Datasheet – End plate with system supply

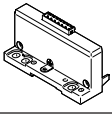
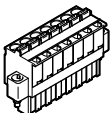
Ordering data			Part no.	Type
End plate with system supply				
	End plate for CPX terminal in polymer design		576315	CPX-EPL-EV-S
Terminal strip				
	Plug, 7-pin, straight	Spring-loaded terminal	576319	NECU-L3G7-C1

Datasheet – End plate with extension

Function

End plates form the outer edge of the CPX terminal.

The earthing connection and mounting holes for wall or DIN rail mounting are located on the left end plates.

The end plates with extension enable the CPX terminal to be separated into two interconnected terminals. Control is provided via a common bus node or control block.

Area of application

- Separation of long CPX terminals into two shorter units
- Adaptation for installation in a control cabinet

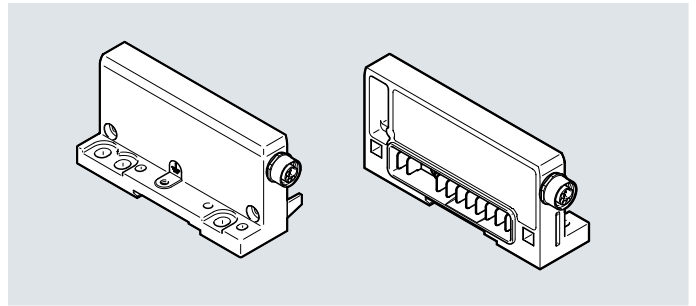
**General technical data**

Type	CPX-EP...	CPX-M-EP...
Type of mounting	Tie rods	Angled fitting
Maximum power supply	[A] 6	6

Materials



Type	CPX-EP...	CPX-M-EP...
Housing	Die-cast aluminium, painted	Die-cast aluminium
Note on materials	RoHS-compliant	RoHS-compliant
LABS (PWIS) conformity	VDMA24364-B2-L	VDMA24364-B2-L

Operating and environmental conditions

Certification	c UL us - Recognized (OL)
---------------	---------------------------

Datasheet – End plate with extension

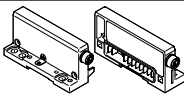
Pin assignment – End plate with extension				
Wiring	Pin	Assignment	Pin	Wiring
Right end plate (first row)	Round plug, 8-pin			Left end plate (second row)
	M12			
	1	0 V DC supply voltage for electronics and sensors	1	
	2	0 V DC load voltage supply for valves	2	
	3	24 V DC load voltage supply for valves	3	
	4	24 V DC supply voltage for electronics and sensors	4	
	5	Bus signal	5	
	6	Bus signal	6	
	7	Bus signal	7	
	8	Bus signal	8	
	Housing	FE	Housing	

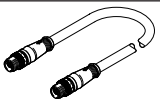
Ordering data					
			Weight [g]	Part no.	Type
End plate with extension					
	For CPX terminal in polymer design	First row, right end plate	190	576313	CPX-EPR-EV-X
		Second row, left end plate	175	576314	CPX-EPL-EV-X
	For CPX terminal in metal design	First row, right end plate	190	576316	CPX-M-EPR-EV-X
		Second row, left end plate	175	576317	CPX-M-EPL-EV-X
Connecting cable					
	8-pin	0.25 m	47	564189	NEBC-F12G8-KH-0.25-N-S-F12G8
		0.5 m	69	564190	NEBC-F12G8-KH-0.5-N-S-F12G8
		1 m	113	564191	NEBC-F12G8-KH-1-N-S-F12G8
		1.5 m	154	564192	NEBC-F12G8-KH-1.5-N-S-F12G8
		2 m	200	576015	NEBC-F12G8-KH-2-N-S-F12G8
		3 m	280	576636	NEBC-F12G8-KH-3-N-S-F12G8

Datasheet – Interlinking block with system supply

Function

Interlinking blocks ensure the electrical supply of all other CPX modules. They have contact rails, from which the other CPX components on the interlinking modules are supplied with power.

The internal division of the power supply allows specific areas of the sensors and actuators to be switched off individually.

Area of application

- 24 V DC supply voltage for the electronics of the CPX terminal
- 24 V DC supply voltage for inputs
- 24 V DC supply voltage for valves
- 24 V DC supply voltage for outputs

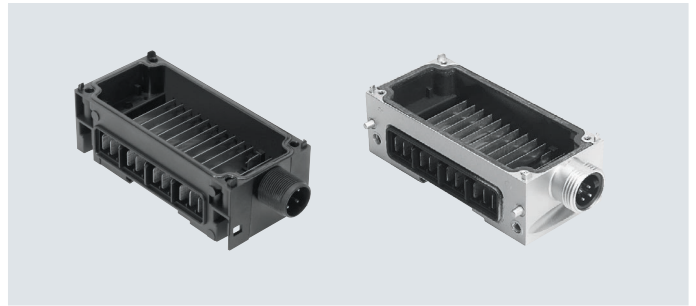

General technical data		
Nominal operating voltage	[V DC]	24
Degree of protection to EN 60529		Depending on connection block
Ambient temperature	[°C]	-5 ... +50
Note on materials		RoHS-compliant
LABS (PWIS) conformity		VDMA24364-B2-L
Grid dimension	[mm]	50
Dimensions W x L x H	[mm]	50 x 107 x 35

Technical data – Polymer interlinking blocks							
Type		CPX-GE-EV-S					
		-VL	-7/8-4POL	-7/8-5POL	-7/8-5POL-VL		
Electrical connection		M18	M18	7/8", 4-pin	7/8", 5-pin	7/8", 5-pin	
Power supply	Sensors and electronics	[A]	Max. 16	Max. 8	Max. 10	Max. 8	Max. 8
	Valves and outputs	[A]	Max. 16	Max. 8	Max. 10	Max. 8	Max. 8
Corrosion resistance class CRC1)			1				
Type of mounting			Tie rods				
Materials			Reinforced PA				
Product weight	[g]		125				

1) More information www.festo.com/x/topic/crc

Datasheet – Interlinking block with system supply

Technical data – Metal interlinking blocks		CPX-M-GE-EV-S				
		-7/8-CIP-4P	-7/8-5POL	-M12-5POL	-7/8-5POL-VL	-PP-5POL
Type						
Electrical connection		7/8", 4-pin	7/8", 5-pin	Plug	7/8", 5-pin	AIDA push-pull, 5-pin
				M12x1		
				5-pin		
				L-coded		
Power supply	Sensors and electronics [A]	Max. 10	Max. 8	Max. 16	Max. 8	Max. 16
	Valves and outputs [A]	Max. 10	Max. 8	Max. 16	Max. 8	Max. 16
Corrosion resistance class CRC1)		0				
Type of mounting		Angled fitting				
Materials		Die-cast aluminium				
Certification		–	–	c UL - Recognized (OL)	–	–
Product weight [g]		187	187	266	187	279

1) More information www.festo.com/x/topic/crc

**Note**

Points to note about the interlinking block CPX-M-GE-EV-S-7/8-CIP-4P:



- Must be mounted as the first module to the right of the left end plate
- The functional earth (FE) must be connected via the left-hand end plate
- Only permitted as an interlinking block to a bus node

Datasheet – Interlinking block with system supply

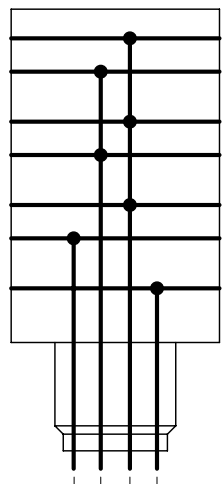
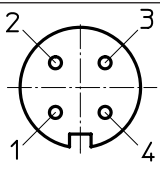
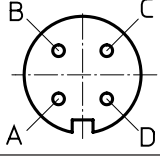
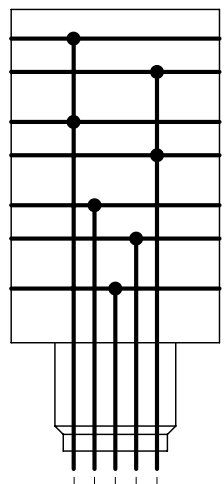
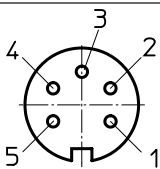
Pin assignment – Polymer interlinking blocks

Wiring		Pin	Assignment																			
Round plug, 4-pin																						
	<p>0V Valves</p> <p>24V Valves</p> <p>0V Output</p> <p>24V Output</p> <p>0V El./Sen.</p> <p>24V El./Sen.</p> <p>FE</p>	<p>M18</p> 	<table border="1"> <tr><td>1</td><td>24 V DC supply voltage for electronics and sensors</td></tr> <tr><td>2</td><td>24 V DC load voltage supply for valves and outputs</td></tr> <tr><td>3</td><td>0 V</td></tr> <tr><td>4</td><td>FE</td></tr> </table>	1	24 V DC supply voltage for electronics and sensors	2	24 V DC load voltage supply for valves and outputs	3	0 V	4	FE											
		1	24 V DC supply voltage for electronics and sensors																			
2	24 V DC load voltage supply for valves and outputs																					
3	0 V																					
4	FE																					
<p>M18</p> <table border="1"> <tr><td>1</td><td>2</td><td>3</td><td>4</td></tr> <tr><td>A</td><td>B</td><td>D</td><td>C</td></tr> <tr><td>24V</td><td>24V</td><td>0V</td><td>FE</td></tr> </table>	1	2	3	4	A	B	D	C	24V	24V	0V	FE	<p>7/8"</p> 	<table border="1"> <tr><td>A</td><td>24 V DC supply voltage for electronics and sensors</td></tr> <tr><td>B</td><td>24 V DC load voltage supply for valves and outputs</td></tr> <tr><td>C</td><td>FE</td></tr> <tr><td>D</td><td>0V</td></tr> </table>	A	24 V DC supply voltage for electronics and sensors	B	24 V DC load voltage supply for valves and outputs	C	FE	D	0V
1	2	3	4																			
A	B	D	C																			
24V	24V	0V	FE																			
A	24 V DC supply voltage for electronics and sensors																					
B	24 V DC load voltage supply for valves and outputs																					
C	FE																					
D	0V																					
Round plug, 5-pin																						
	<p>0V Valves</p> <p>24V Valves</p> <p>0V Output</p> <p>24V Output</p> <p>0V El./Sen.</p> <p>24V El./Sen.</p> <p>FE</p>	<p>7/8"</p> 	<table border="1"> <tr><td>1</td><td>0 V valves and outputs</td></tr> <tr><td>2</td><td>0 V electronics and sensors</td></tr> <tr><td>3</td><td>FE</td></tr> <tr><td>4</td><td>24 V DC supply voltage for electronics and sensors</td></tr> <tr><td>5</td><td>24 V DC load voltage supply for valves and outputs</td></tr> </table>	1	0 V valves and outputs	2	0 V electronics and sensors	3	FE	4	24 V DC supply voltage for electronics and sensors	5	24 V DC load voltage supply for valves and outputs									
		1	0 V valves and outputs																			
2	0 V electronics and sensors																					
3	FE																					
4	24 V DC supply voltage for electronics and sensors																					
5	24 V DC load voltage supply for valves and outputs																					
<p>7/8"</p> <table border="1"> <tr><td>1</td><td>2</td><td>3</td><td>4</td><td>5</td></tr> <tr><td>0V</td><td>0V</td><td>FE</td><td>24V</td><td>24V</td></tr> </table>	1	2	3	4	5	0V	0V	FE	24V	24V												
1	2	3	4	5																		
0V	0V	FE	24V	24V																		

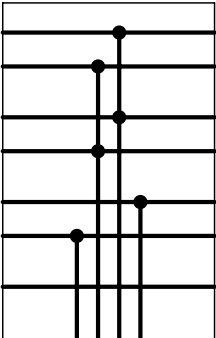
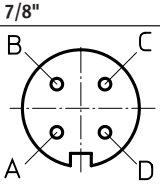

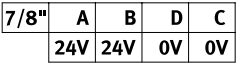
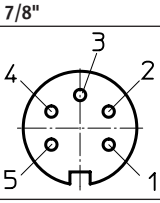
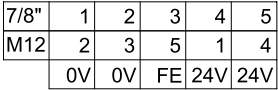
Datasheet – Interlinking block with system supply

Pin assignment – Metal interlinking blocks		Pin	Assignment
Wiring			
Round plug, 4-pin			
 <p>0V Valves 24V Valves 0V Output 24V Output 0V El./Sen. 24V El./Sen. FE</p>	 <p>7/8"</p>	A	24 V DC supply voltage for electronics and sensors
		B	24 V DC load voltage supply for valves and outputs
		C	0 V DC supply voltage for electronics and sensors
		D	0 V DC load voltage supply for valves and outputs
		 Note The functional earth (FE) must be connected via the left-hand end plate.	
 <p>7/8" A B D C 24V 24V 0V 0V</p>			
Round plug, 5-pin			
 <p>0V Valves 24V Valves 0V Output 24V Output 0V El./Sen. 24V El./Sen. FE</p>	 <p>7/8"</p>	1	0 V valves and outputs
		2	0 V electronics and sensors
		3	FE
		4	24 V DC supply voltage for electronics and sensors
		5	24 V DC load voltage supply for valves and outputs
		M12	
		1	24 V DC supply voltage for electronics and sensors
		2	0 V valves and outputs
		3	0 V electronics and sensors
		4	24 V DC load voltage supply for valves and outputs
		FE	FE
 <p>7/8" 1 2 3 4 5 M12 2 3 5 1 4 0V 0V FE 24V 24V</p>			

Datasheet – Interlinking block with system supply

Pin assignment – Metal interlinking blocks		Pin	Assignment																						
Wiring																									
Push-pull plug 5-pin																									
<p>0V Valves 24V Valves 0V Output 24V Output 0V El./Sen. 24V El./Sen. FE</p> <table border="1"> <tr> <td>PP</td> <td>1</td> <td>2</td> <td>3</td> <td>4</td> <td>5</td> </tr> <tr> <td></td> <td>24V</td> <td>0V</td> <td>24V</td> <td>0V</td> <td>FE</td> </tr> </table>	PP	1	2	3	4	5		24V	0V	24V	0V	FE	Plug pattern to PROFINET specification <table border="1"> <tr> <td>1</td> <td>24 V DC supply voltage for electronics and sensors</td> </tr> <tr> <td>2</td> <td>0 V electronics and sensors</td> </tr> <tr> <td>3</td> <td>24 V DC load voltage supply for valves and outputs</td> </tr> <tr> <td>4</td> <td>0 V valves and outputs</td> </tr> <tr> <td>5</td> <td>FE</td> </tr> </table>			1	24 V DC supply voltage for electronics and sensors	2	0 V electronics and sensors	3	24 V DC load voltage supply for valves and outputs	4	0 V valves and outputs	5	FE
	PP	1	2	3	4	5																			
	24V	0V	24V	0V	FE																				
1	24 V DC supply voltage for electronics and sensors																								
2	0 V electronics and sensors																								
3	24 V DC load voltage supply for valves and outputs																								
4	0 V valves and outputs																								
5	FE																								

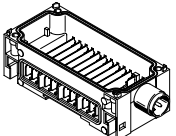
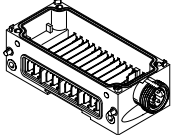
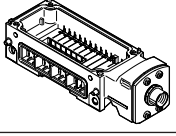
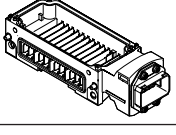
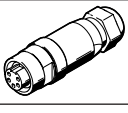
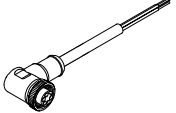
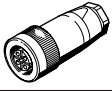
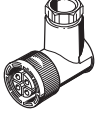

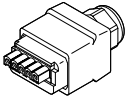
Datasheet – Interlinking block with system supply

Ordering data				Part no.	Type
Designation					
Interlinking block with system supply					
	M18 connection, polymer interlinking block	4-pin	–	195746	CPX-GE-EV-S
			For ATEX environment	8022170	CPX-GE-EV-S-VL
	7/8" connection, polymer interlinking block	4-pin	–	541248	CPX-GE-EV-S-7/8-4POL
			5-pin	–	541244
	7/8" connection, metal interlinking block	4-pin	–	568956	CPX-M-GE-EV-S-7/8-CIP-4P
			5-pin	–	550208
		For ATEX environment	8022165	CPX-M-GE-EV-S-7/8-5POL-VL	
	M12x1 L-coded connection, metal interlinking block	5-pin	–	8098392	CPX-M-GE-EV-S-M12-5POL
	Push-pull plug connection (AIDA), metal interlinking block	5-pin	–	563057	CPX-M-GE-EV-S-PP-5POL
Connection sockets 7/8"					
	Power supply socket	5-pin		543107	NECU-G78G5-C2
		4-pin		543108	NECU-G78G4-C2
	Angled socket, 5-pin – open cable end, 5-core	2 m		573855	NEBU-G78W5-K-2-N-LE5
Connection sockets M18					
	Straight socket, screw terminal	4-pin	PG9	18493	NTSD-GD-9
			PG13.5	18526	NTSD-GD-13,5
	Angled socket, screw terminal	4-pin	PG9	18527	NTSD-WD-9
	Angled socket, screw terminal	4-pin	PG11	533119	NTSD-WD-11
Power supply sockets M12					
	Straight socket, screw terminal	5-pin		8166793	NECL-L12G5-C2-Q10
	Angled socket, screw terminal	5-pin		8166794	NECL-L12W5-C2-Q10
Push-pull power supply socket					
	Socket, spring-loaded terminal, Plug pattern PP, fulfils requirements to AIDA	5-pin		5195383	NECU-M-PPG5PP-C1-PN

Datasheet – Interlinking block with system supply

Ordering data		Part no.	Type
Designation			
Mounting accessories			
	Screws for mounting the bus node/connection block on the polymer interlinking block	Bus node/metal connection block	550218 CPX-DPT-30X32-S-4X
	Screws for mounting the bus node/connection block on the metal interlinking block	Bus node/polymer connection block	550219 CPX-M-M3x22-4x
		Bus node/metal connection block	550216 CPX-M-M3x22-S-4x

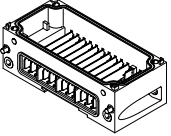
Datasheet – Interlinking block without power supply

Ordering data					
Designation			Part no.	Type	
Interlinking block without power supply					
	Polymer interlinking block		195742	CPX-GE-EV	
	Metal interlinking block		550206	CPX-M-GE-EV	
Mounting accessories					
	Screws for mounting the bus node/connection block on the polymer interlinking block		Bus node/metal connection block	550218	CPX-DPT-30X32-S-4X
	Screws for mounting the bus node/connection block on the metal interlinking block		Bus node/polymer connection block	550219	CPX-M-M3x22-4x
			Bus node/metal connection block	550216	CPX-M-M3x22-S-4x

Datasheet – Interlinking block with additional supply for outputs

Function

Interlinking blocks ensure the electrical supply of all other CPX modules. They have contact rails, from which the other CPX components on the interlinking modules are supplied with power.

The internal division of the power supply allows specific areas of the sensors and actuators to be switched off individually.

Area of application

- 24 V DC supply voltage for outputs



General technical data		
Nominal operating voltage	[V DC]	24
Degree of protection to EN 60529		Depending on connection block
Ambient temperature	[°C]	-5 ... +50
Note on materials		RoHS-compliant
LABS (PWIS) conformity		VDMA24364-B2-L
Grid dimension	[mm]	50
Dimensions W x L x H	[mm]	50 x 107 x 35

Technical data – Polymer interlinking blocks			
Type		CPX-GE-EV-Z	
		-7/8-4POL	-7/8-5POL
Electrical connection		M18	7/8", 4-pin
Power supply	Outputs	[A]	Max. 16
			Max. 10
			Max. 8
Materials		Reinforced PA	
Product weight	[g]	125	

Technical data – Metal interlinking blocks			
Type		CPX-M-GE-EV-Z	
		-7/8-5POL	-PP-5POL
Electrical connection		7/8", 5-pin	AIDA push-pull, 5-pin
Power supply	Outputs	[A]	Max. 8
			Max. 16
Materials		Die-cast aluminium	
Product weight	[g]	187	279



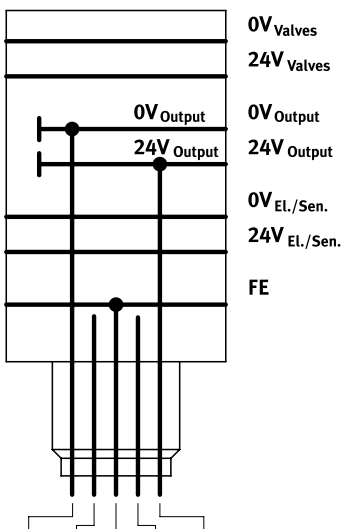
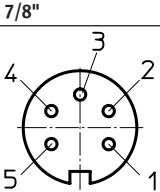
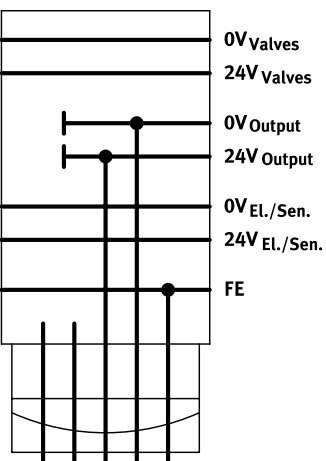
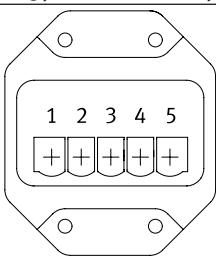

Datasheet – Interlinking block with additional supply for outputs

Pin assignment – Polymer interlinking blocks		Pin	Assignment															
Wiring																		
Round plug, 4-pin																		
	0V Valves																	
	24V Valves																	
	0V Output																	
	24V Output																	
	0V El./Sen.																	
	24V El./Sen.																	
	FE																	
<table border="1"> <tr> <td>M18</td> <td>1</td> <td>2</td> <td>3</td> <td>4</td> </tr> <tr> <td>7/8"</td> <td>A</td> <td>B</td> <td>D</td> <td>C</td> </tr> <tr> <td></td> <td>n.c.</td> <td>24V</td> <td>0V</td> <td>FE</td> </tr> </table>	M18	1	2	3	4	7/8"	A	B	D	C		n.c.	24V	0V	FE			
M18	1	2	3	4														
7/8"	A	B	D	C														
	n.c.	24V	0V	FE														
			<table border="1"> <tr> <td>1</td> <td>n.c.</td> </tr> <tr> <td>2</td> <td>24 V DC load voltage supply for outputs</td> </tr> <tr> <td>3</td> <td>0 V</td> </tr> <tr> <td>4</td> <td>FE</td> </tr> </table>	1	n.c.	2	24 V DC load voltage supply for outputs	3	0 V	4	FE							
1	n.c.																	
2	24 V DC load voltage supply for outputs																	
3	0 V																	
4	FE																	
			<table border="1"> <tr> <td>A</td> <td>n.c.</td> </tr> <tr> <td>B</td> <td>24 V DC load voltage supply for outputs</td> </tr> <tr> <td>C</td> <td>FE</td> </tr> <tr> <td>D</td> <td>0V</td> </tr> </table>	A	n.c.	B	24 V DC load voltage supply for outputs	C	FE	D	0V							
A	n.c.																	
B	24 V DC load voltage supply for outputs																	
C	FE																	
D	0V																	
Round plug, 5-pin																		
	0V Valves																	
	24V Valves																	
	0V Output																	
	24V Output																	
	0V El./Sen.																	
	24V El./Sen.																	
	FE																	
<table border="1"> <tr> <td>7/8"</td> <td>1</td> <td>2</td> <td>3</td> <td>4</td> <td>5</td> </tr> <tr> <td></td> <td>0V</td> <td>n.c.</td> <td>FE</td> <td>n.c.</td> <td>24V</td> </tr> </table>	7/8"	1	2	3	4	5		0V	n.c.	FE	n.c.	24V						
7/8"	1	2	3	4	5													
	0V	n.c.	FE	n.c.	24V													
			<table border="1"> <tr> <td>1</td> <td>0 V outputs</td> </tr> <tr> <td>2</td> <td>n.c.</td> </tr> <tr> <td>3</td> <td>FE</td> </tr> <tr> <td>4</td> <td>n.c.</td> </tr> <tr> <td>5</td> <td>24 V DC load voltage supply for outputs</td> </tr> </table>	1	0 V outputs	2	n.c.	3	FE	4	n.c.	5	24 V DC load voltage supply for outputs					
1	0 V outputs																	
2	n.c.																	
3	FE																	
4	n.c.																	
5	24 V DC load voltage supply for outputs																	

Datasheet – Interlinking block with additional supply for outputs

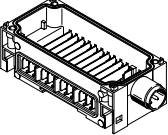
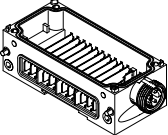
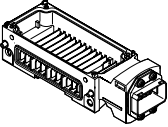
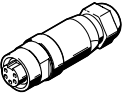
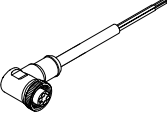
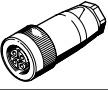
Pin assignment – Metal interlinking blocks		Pin	Assignment												
Wiring															
Round plug, 5-pin															
		1	0 V outputs												
		2	n.c.												
		3	FE												
		4	n.c.												
		5	24 V DC load voltage supply for outputs												
<table border="1" data-bbox="127 907 422 974"> <tr> <td>7/8"</td> <td>1</td> <td>2</td> <td>3</td> <td>4</td> <td>5</td> </tr> <tr> <td></td> <td>0V</td> <td>n.c.</td> <td>FE</td> <td>n.c.</td> <td>24V</td> </tr> </table>	7/8"	1	2	3	4	5		0V	n.c.	FE	n.c.	24V			
7/8"	1	2	3	4	5										
	0V	n.c.	FE	n.c.	24V										
Push-pull plug 5-pin															
		1	n.c.												
		2	n.c.												
		3	24 V DC load voltage supply for outputs												
		4	0 V outputs												
		5	FE												
<table border="1" data-bbox="143 1556 422 1624"> <tr> <td>PP</td> <td>1</td> <td>2</td> <td>3</td> <td>4</td> <td>5</td> </tr> <tr> <td></td> <td>n.c.</td> <td>n.c.</td> <td>24V</td> <td>0V</td> <td>FE</td> </tr> </table>	PP	1	2	3	4	5		n.c.	n.c.	24V	0V	FE			
PP	1	2	3	4	5										
	n.c.	n.c.	24V	0V	FE										

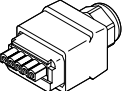
Datasheet – Interlinking block with additional supply for outputs

Ordering data					
Designation				Part no.	Type
Interlinking block with additional supply for outputs					
	M18 connection, polymer interlinking block	4-pin	–	195744	CPX-GE-EV-Z
	7/8" connection, polymer interlinking block	4-pin	–	541250	CPX-GE-EV-Z-7/8-4POL
		5-pin	–	541246	CPX-GE-EV-Z-7/8-5POL
	7/8" connection, metal interlinking block	5-pin	–	550210	CPX-M-GE-EV-Z-7/8-5POL
	Push-pull plug connection (AIDA), metal interlinking block	5-pin	–	563058	CPX-M-GE-EV-Z-PP-5POL
Connection sockets 7/8"					
	Power supply socket	5-pin		543107	NECU-G78G5-C2
		4-pin		543108	NECU-G78G4-C2
	Angled socket, 5-pin – open cable end, 5-core	2 m		573855	NEBU-G78W5-K-2-N-LE5
Connection sockets M18					
	Straight socket, screw terminal	4-pin	PG9	18493	NTSD-GD-9
			PG13.5	18526	NTSD-GD-13,5
	Angled socket, screw terminal	4-pin	PG9	18527	NTSD-WD-9
	Angled socket, screw terminal	4-pin	PG11	533119	NTSD-WD-11
Push-pull power supply socket					
	Socket, spring-loaded terminal, Plug pattern PP, fulfils requirements to AIDA	5-pin		5195383	NECU-M-PPG5PP-C1-PN
Mounting accessories					
	Screws for mounting the bus node/connection block on the polymer interlinking block	Bus node/metal connection block		550218	CPX-DPT-30X32-S-4X
	Screws for mounting the bus node/connection block on the metal interlinking block	Bus node/polymer connection block		550219	CPX-M-M3x22-4x
		Bus node/metal connection block		550216	CPX-M-M3x22-S-4x

Datasheet – Interlinking block with additional supply for valves

Function

Interlinking blocks ensure the electrical supply of all other CPX modules.

They have contact rails, from which the other CPX components on the interlinking modules are supplied with power.

The internal division of the power supply allows specific areas of the sensors and actuators to be switched off individually.

Area of application



- 24 V DC supply voltage for valves



General technical data		
Type		CPX-GE-EV-V
Electrical connection		M18
Nominal operating voltage	[V DC]	24
Current carrying capacity (per contact/contact rail)	[A]	16
Degree of protection to EN 60529		Depending on connection block
Ambient temperature	[°C]	-5 ... +50
Materials		Reinforced PA
Note on materials		RoHS-compliant
LABS (PWIS) conformity		VDMA24364-B2-L
Grid dimension	[mm]	50
Dimensions W x L x H	[mm]	50 x 107 x 35
Product weight	[g]	125

Pin assignment – Polymer interlinking blocks		Pin	Assignment															
Wiring																		
Round plug, 4-pin																		
		1	n.c.															
		2	24 V DC load voltage supply for valves															
		3	0 V															
		4	FE															
<table border="1"> <thead> <tr> <th>M18</th> <th>1</th> <th>2</th> <th>3</th> <th>4</th> </tr> </thead> <tbody> <tr> <td>7/8"</td> <td>A</td> <td>B</td> <td>D</td> <td>C</td> </tr> <tr> <td></td> <td>n.c.</td> <td>24V</td> <td>0V</td> <td>FE</td> </tr> </tbody> </table>	M18	1	2	3	4	7/8"	A	B	D	C		n.c.	24V	0V	FE			
M18	1	2	3	4														
7/8"	A	B	D	C														
	n.c.	24V	0V	FE														

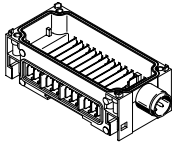
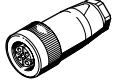
Datasheet – Interlinking block with additional supply for valves

Ordering data				Part no.	Type
Designation					
Interlinking block with additional supply for valves					
	M18 connection, polymer interlinking block	4-pin	–	533577	CPX-GE-EV-V
Connection sockets M18					
	Straight socket, screw terminal	4-pin	PG9	18493	NTSD-GD-9
		4-pin	PG13.5	18526	NTSD-GD-13,5
	Angled socket, screw terminal	4-pin	PG9	18527	NTSD-WD-9
		4-pin	PG11	533119	NTSD-WD-11
Mounting accessories					
	Screws for mounting the bus node/connection block on the polymer interlinking block	Bus node/metal connection block		550218	CPX-DPT-30X32-S-4X

Datasheet – Interlinking block with system forwarding

Function

Interlinking blocks ensure the electrical supply of all other CPX modules. They have contact rails, from which the other CPX components on the interlinking modules are supplied with power. The internal division of the power supply allows specific areas of the sensors and actuators to be switched off individually.

Area of application

- Forwarding of 24 V DC supply voltage for the electronics of the CPX terminal
- Forwarding of 24 V DC supply voltage for inputs
- Forwarding of 24 V DC supply voltage for valves
- Forwarding of 24 V DC supply voltage for outputs



General technical data		
Nominal operating voltage	[V DC]	24
Degree of protection to EN 60529		Depending on connection block
Ambient temperature	[°C]	-5 ... +50
Note on materials		RoHS-compliant
LABS (PWIS) conformity		VDMA24364-B2-L
Grid dimension	[mm]	50
Dimensions W x L x H	[mm]	50 x 107 x 35

Technical data – Metal interlinking blocks			
Type	CPX-M-GE-EV-W-M12-5POL		
Electrical connection	Socket		
	M12x1		
	5-pin		
	L-coded		
Power supply	Sensors and electronics	[A]	Max. 16
	Valves and outputs	[A]	Max. 16
Corrosion resistance class CRC1)	0		
Type of mounting	Angled fitting		
Materials	Die-cast aluminium		
Certification	c UL - Recognized (OL)		
Product weight	[g]	266	

1) More information www.festo.com/x/topic/crc



Note

Points to note about the interlinking block CPX-M-GE-EV-W-M12-5POL:

- Must be mounted as the first module to the right or left of the system supply
- Only one interlinking block permitted per CPX terminal

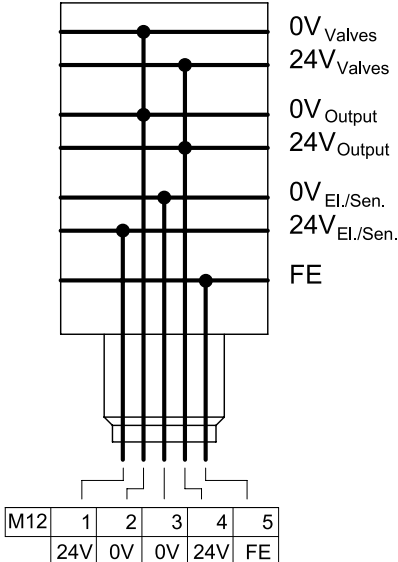
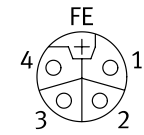
Datasheet – Interlinking block with forwarding supply

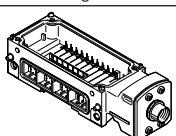
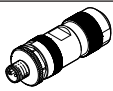
Pin assignment – Metal interlinking blocks		Pin	Assignment
Wiring			
Round plug, 5-pin			
	M12 		1 24 V DC supply voltage for electronics and sensors 2 0 V valves and outputs 3 0 V electronics and sensors 4 24 V DC load voltage supply for valves and outputs FE FE

Ordering data				
Designation		Part no.	Type	
Interlinking block with system forwarding				
	M12x1 L-coded connection, metal interlinking block	5-pin	8098391	CPX-M-GE-EV-W-M12-5POL
Power supply plugs M12				
	Straight plug, screw terminal	5-pin	8166791	NECL-S-L12G5-C2-Q10
	Angled plug, screw terminal	5-pin	8166792	NECL-S-L12W5-C2-Q10

Datasheet – Pneumatic interface for valve terminal MPA-S

Function

The pneumatic interface VMFA-FB establishes the electromechanical connection between the CPX terminal and the valve terminal MPA-S.

The signals from the bus node are forwarded to the control electronics in the electrical modules of the valve terminal MPA-S via the integrated CPX bus.

The bus signal for activating the solenoid coils is converted in the electronics module for max. 8 coils.

From a technical point of view, the individual MPA pneumatic modules each represent a separate electrical module with digital outputs. Valves, which are galvanically isolated, can be supplied with power via the interlinking block CPX-GE-EV-V.

Area of application

- Interface to the valve terminal MPA-S
- Max. 128 solenoid coils
- Characteristics of the electronics module of the valve terminal MPA-S can be parameterised; for example, status of the solenoid coils in the event of fieldbus communication being interrupted (fail-safe), individual channel diagnostics can be activated, condition monitoring can be activated individually for each valve
- The pneumatic interface receives the voltage for the electronics and the supply voltage for the valves from the left-hand interlinking block and feeds them through to the electronics modules of the valve terminal MPA-S
- Electronics modules of the valve terminal MPA-S:
 - Undervoltage of valves
 - Short circuit of valves
 - Open load of valves
 - Counter preset reached in condition monitoring



General technical data		VMFA-FB-EPL-G	VMFA-FB-EPL-E
Type			
Valve terminal design		Modular, valve sizes can be mixed	
Maximum number of valve positions		64	
Maximum number of pressure zones		17	
Signal status indication		LED	
Pilot air supply		Internal	External
Operating pressure	[MPa]	0.3 ... 0.8	-0.09 ... 1
	[bar]	3 ... 8	-0.9 ... 10
Pilot pressure	[MPa]	0.3 ... 0.8	0.3 ... 0.8
	[bar]	3 ... 8	3 ... 8
Product weight	[g]	320	
Degree of protection		IP67	

Technical data – Electrics		
Nominal operating voltage	[V DC]	24
Permissible voltage fluctuations	[%]	±25

Materials	
Note on materials	RoHS-compliant
LABS (PWIS) conformity	VDMA24364-B1/B2-L

Accessories – Pneumatic interface for valve terminal MPA-S

Operating and environmental conditions	
Operating medium	Compressed air to ISO 8573-1:2010 [7:4:4]
Note on the operating/pilot medium	Lubricated operation possible (in which case lubricated operation will always be required)
Ambient temperature [°C]	-5 ... +50
Temperature of medium [°C]	-5 ... +50
Storage temperature [°C]	-20 ... +40
Relative humidity	Max. 90% at 40 °C
Corrosion resistance class CRC ¹⁾	1
CE marking (see declaration of conformity)	To EU EMC Directive ²⁾
	To EU RoHS Directive
	To EU Explosion Protection Directive (ATEX)
UKCA marking (see declaration of conformity)	To UK EMC regulations
	To UK RoHS regulations
	To UK explosion regulations
KC marking	KC EMC
Certification	RCM
	c UL us - Recognized (OL)
Certificate-issuing authority	DNV 15.0193 X

1) More information www.festo.com/x/topic/crc

2) For information about the area of use, see the EC declaration of conformity at: [www.festo.com/catalogue/... d Support/Downloads](http://www.festo.com/catalogue/...d/Support/Downloads).

If the devices are subject to usage restrictions in residential, commercial or light-industrial environments, further measures for the reduction of the emitted interference may be necessary.

ATEX	
ATEX category for gas	II 3G
Type of (ignition) protection for gas	Ex ec IIC T4 Gc X
Explosion-proof ambient temperature [°C]	-5 ≤ Ta ≤ +50
Explosion protection certification outside the EU	EPL Db (GB)
	EPL Gb (GB)

Overview – Pneumatic interface VMPA-FB

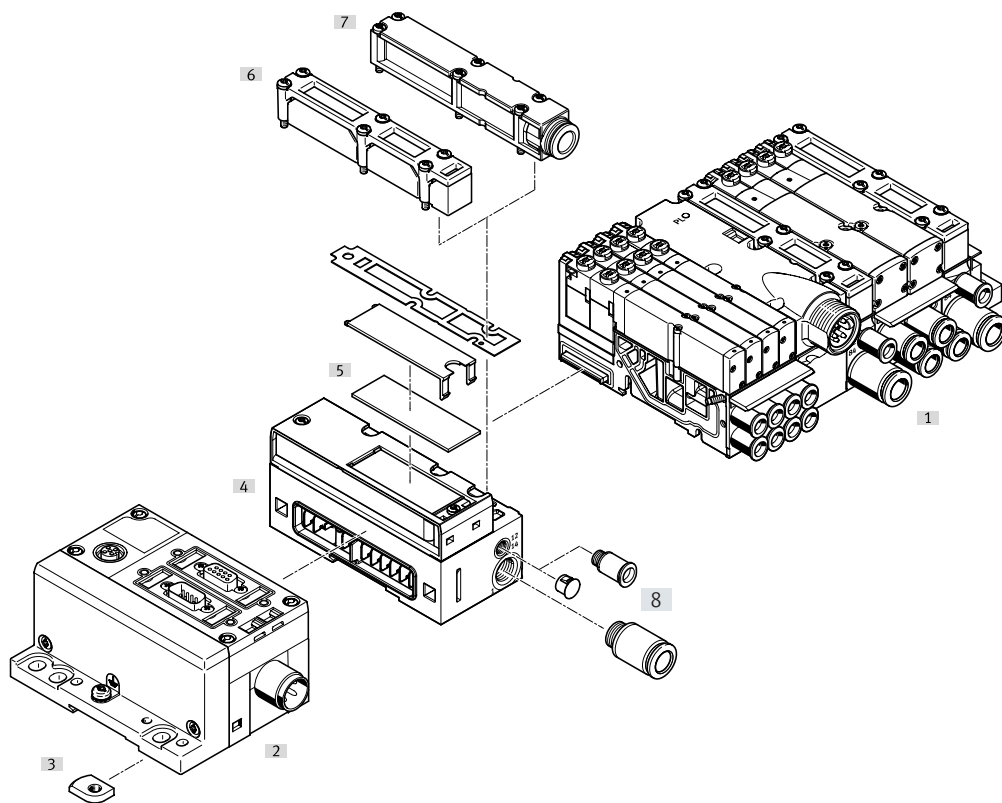

- [1] Valve terminal MPA-S
- [2] Terminal CPX
- [3] Mounting for DIN rail
- [4] Pneumatic interface VMPA-FB
- [5] Inscription labels
- [6] Flat plate silencer
- [7] Exhaust plate for ducted exhaust air
- [8] Fittings

Accessories – Pneumatic interface for valve terminal MPA-S

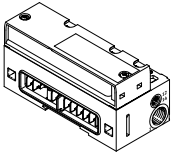
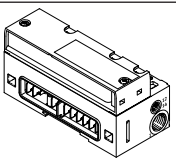
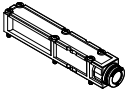
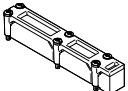
Ordering data			
Designation		Part no.	Type
Pneumatic interface for CPX polymer interlinking module			
	Ducted exhaust air, internal pilot air	533370	VMPA-FB-EPL-G
	Ducted exhaust air, external pilot air	533369	VMPA-FB-EPL-E
	Flat plate silencer, internal pilot air	533372	VMPA-FB-EPL-GU
	Flat plate silencer, external pilot air	533371	VMPA-FB-EPL-EU
Pneumatic interface for CPX metal interlinking module			
	Ducted exhaust air, internal pilot air	552286	VMPA-FB-EPLM-G
	Ducted exhaust air, external pilot air	552285	VMPA-FB-EPLM-E
	Flat plate silencer, internal pilot air	552288	VMPA-FB-EPLM-GU
	Flat plate silencer, external pilot air	552287	VMPA-FB-EPLM-EU
Exhaust plate			
	For ducted exhaust air, with 10 mm push-in connector	533375	VMPA-AP
	For ducted exhaust air, with QS-3/8 connector	541629	VMPA-AP-3/8
	Flat plate silencer	533374	VMPA-APU

Datasheet – Pneumatic interface for valve terminal MPA-L

Function

The pneumatic interface VMPAL establishes the electromechanical connection between the terminal CPX and the valve terminal MPA-L.

The bus signal for actuating the solenoid coils is converted in the pneumatic interface for the entire valve terminal. The interlinking within the valve terminal is identical with the interlinking with multi-pin plug connections.

Area of application

- Actuation of the valve terminal MPA-L
- Max. 32 solenoid coils
- The pneumatic interface receives the voltage for the electronics and the supply voltage for the valves from the left-hand interlinking block and feeds them through to the electrical modules of the valve terminal MPA-L



General technical data		
Type		VMPAL-EPL-CPX
Number of valve coils		32
Operating pressure	[bar]	-0.9 ... 10
Pilot pressure	[bar]	3 ... 8
Nominal operating voltage	[V DC]	24
Degree of protection to EN 60529		IP67
Ambient temperature	[°C]	-5 ... +50
Note on materials		RoHS-compliant
LABS (PWS) conformity		VDMA24364-B1/B2-L

Datasheet – Pneumatic interface for valve terminal MPA-L

Overview – Pneumatic interface VMPAL

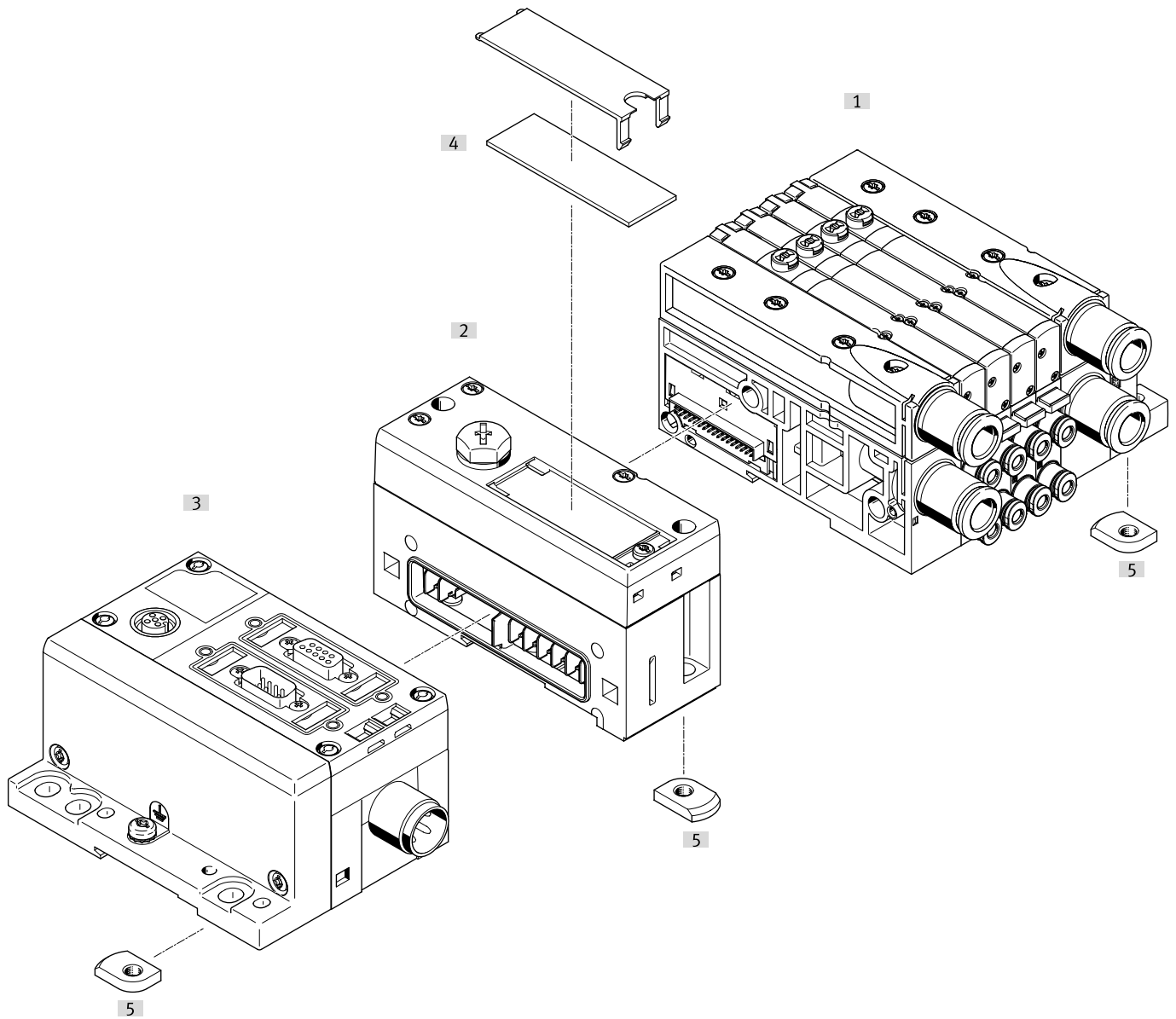

[1] Valve terminal MPA-L
[2] Pneumatic interface VMPAL

[3] Terminal CPX

[4] Inscription labels

[5] Mounting for DIN rail

Ordering data

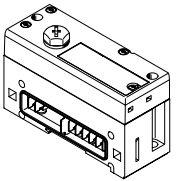
Designation	Part no.	Type
 Pneumatic interface for CPX polymer interlinking module	570783	VMPAL-EPL-CPX

Datasheet – Pneumatic interface for valve terminal VTSA/VTSA-F

Function

The pneumatic interface VTSA provides the electromechanical connection between the terminal CPX and valve terminal VTSA/VTSA-F.

A complete pneumatic control loop system (FB-valve-drive-sensor-FB) can therefore be connected to the fieldbus using the input modules of the CPX terminal.

Different circuits for valves and electrical outputs are implemented using an additional supply. The integrated valve diagnostics enable the causes of errors to be identified quickly, thus increasing system availability.

Area of application

- Interface to the valve terminal VTSA and VTSA-F
- Max. 32 solenoid coils
- Address space allocation (configuration) of valve terminals can be set using integrated DIL switches
- Properties of the pneumatic interface can be parameterised, e.g. status of the solenoid coil in the event of fieldbus communication being interrupted (fail-safe)
- The pneumatic interface receives the voltage for the electronics and the supply voltage for the valves from the left interlinking block
- Detecting missing solenoid coils and short circuit monitoring for the valves



General technical data			
Max. number of valve positions	16 with double solenoid valves		
	32 with single solenoid valves		
Valve terminal interface	Type 44, VTSA		
Electrical control	Fieldbus		
Electrical connection	Via CPX		
Diagnostics	Undervoltage of valves		
Parameterisation	Fail-safe per channel		
	Forcing per channel		
	Idle mode per channel		
	Module monitoring		
LED indicators	1 group diagnostics		
	Channel status on valves		
Fuse protection (short circuit)	Internal electronic fuse per valve output		
Galvanic isolation channel – internal bus	Yes, when using an additional supply for the valves		
Nominal operating voltage	[V DC]	24	
Operating voltage range	[V DC]	21.6 ... 26.4	
Intrinsic current consumption at nominal operating voltage	Electronics	[mA]	Typically 15
	Valves	[mA]	Typically 50
Max. power supply per channel	[A]	0.2	
Max. total current per module	[A]	4	
Degree of protection	IP65		
	NEMA 4		
Product weight	[g]	590	

Datasheet – Pneumatic interface for valve terminal VTSA/VTSA-F

Materials	
Housing	Die-cast aluminium
Cover	PA
Note on materials	RoHS-compliant
LABS (PWIS) conformity	VDMA24364-B1/B2-L

Operating and environmental conditions		
Ambient temperature	[°C]	-5 ... +50
Corrosion resistance class (CRC1)		0

1) More information www.festo.com/x/topic/crc

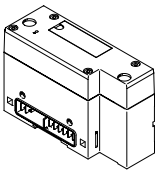
Ordering data				
Designation		Part no.	Type	
	For polymer interlinking block	543416	VABA-S6-1-X1	
	For metal interlinking block	Diagnostics via fieldbus	550663	VABA-S6-1-X2
		Diagnostics via process data image	573613	VABA-S6-1-X2-D

Datasheet – Pneumatic interface for valve terminal VTSA-F-CB

Function

The pneumatic interface provides the electromechanical connection between the terminal CPX and valve terminal VTSA-F-CB.

A complete pneumatic control loop system (FB-valve-drive-sensor-FB) can therefore be connected to the fieldbus using the input modules of the CPX terminal.

Different circuits for valves and electrical outputs are implemented using an additional supply. The integrated valve diagnostics enable the causes of errors to be identified quickly, thus increasing system availability.

Area of application

- Interface to valve terminal VTSA-F-CB
- Max. 24 solenoid coils
- Properties of the pneumatic interface can be parameterised, e.g. status of the solenoid coil in the event of fieldbus communication being interrupted (fail-safe)
- The pneumatic interface receives the voltage for the electronics and the supply voltage for the valves from the left-hand interlinking block
- The supply voltage for the valves is provided from the left-hand interlinking block or externally
- Detecting missing solenoid coils and short circuit monitoring for the valves

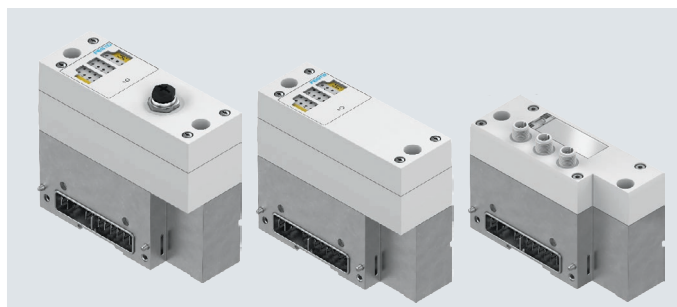

General technical data		Pneumatic interface		
		Without voltage zones	With safe voltage zones	With external power supply to the valves
Max. number of valve positions		12 with double solenoid valves 24 with single solenoid valves		
Valve terminal interface		Type 44, VTSA		
Electrical control		Fieldbus		
Electrical connection		Via CPX		
Electrical connection output	Function	–	Safe digital output	–
	Connection type	–	Socket	–
	Connection technology	–	M12x1, A-coded to EN 61076-2-101	–
	Number of pins/cores	–	5	–
Electrical connection, power supply to valves	Function	–	–	–
	Connection type	–	–	Plug
	Connection technology	–	–	3x M12x1, A-coded
	Number of pins/cores	–	–	5
Diagnostics		Wire break per valve coil Short circuit of valves Undervoltage of valves		
Parameterisation		Fail-safe per channel Forcing per channel Idle mode per channel Module monitoring		
LED indicators	1 group diagnostics	1 group diagnostics	1 group diagnostics	
	Channel status on valves	–	Channel status on valves	
	–	–	3 load supply	

Datasheet – Pneumatic interface for valve terminal VTSA-F-CB

Technical data – Electrics		Pneumatic interface			
		Without voltage zones	With safe voltage zones	With external power supply to the valves	
Nominal operating voltage	[V DC]	24			
Operating voltage range	[V DC]	21.6 ... 26.4			
Intrinsic current consumption at nominal operating voltage	Electronics	[mA]	Typically 11	<ul style="list-style-type: none"> Typically 45 for electronics without CPX-FVDA-P2 Typically 110 for electronics with CPX-FVDA-P2 	Typically 11
	Valves	[mA]	Typically 45	<ul style="list-style-type: none"> Typically 25 for valves without CPX-FVDA-P2 Typically 90 for valves with CPX-FVDA-P2 	Typically 45
Max. power supply per channel	[A]	0.2	0.2	0.2	
Max. total current per module	[A]	6	4.5	6	
Fuse protection (short circuit)		Internal electronic fuse per valve output	Internal electronic fuse per valve output	Internal electronic fuse per valve output	
Galvanic isolation channel – internal bus		Yes, when using an additional supply for the valves	Yes, when using an additional supply for the valves	Yes	

Materials		Pneumatic interface		
		Without voltage zones	With safe voltage zones	With external power supply to the valves
Housing		Die-cast aluminium	–	Die-cast aluminium
Cover		PA	PA	PA
Sub-base		–	Die-cast aluminium	–
Seals		–	NBR	–
Screws		–	Steel	–
Note on materials		RoHS-compliant	RoHS-compliant	RoHS-compliant
LABS (PWIS) conformity		VDMA24364-B1/B2-L	VDMA24364-B1/B2-L	VDMA24364-B1/B2-L

Operating and environmental conditions		Pneumatic interface		
		Without voltage zones	With safe voltage zones	With external power supply to the valves
Ambient temperature	[°C]	–5 ... +50	–5 ... +50	–5 ... +50
Storage temperature	[°C]	–	–20 ... +60	–
Corrosion resistance class CRC1)		0	0	0
Shock resistance		–	Shock test with severity level 2 to FN 942017-5 and EN 60068-2-27	–
Vibration resistant		–	Transport application test with severity level 2 to FN 942017-4 and EN 60068-2-6	–
CE marking (see declaration of conformity) ³⁾		–	To EU EMC Directive ²⁾	–
		–	To EU RoHS Directive	–
UKCA marking (see declaration of conformity) ³⁾		–	To UK EMC regulations	–
		–	To UK RoHS regulations	–
Degree of protection		IP65	IP65	IP65
		NEMA 4	–	NEMA 4

1) More information www.festo.com/x/topic/crc2) For information about the area of use, see the EC declaration of conformity at: [www.festo.com/catalogue/... d Support/Downloads](http://www.festo.com/catalogue/...d/Support/Downloads).

If the devices are subject to usage restrictions in residential, commercial or light-industrial environments, further measures for the reduction of the emitted interference may be necessary.

3) More information [www.festo.com/catalogue/... → Support/Downloads](http://www.festo.com/catalogue/...>Support/Downloads).

Datasheet – Pneumatic interface for valve terminal VTSA-F-CB

Combinations of bus nodes/control blocks with pneumatic interface

Bus node/control block	Part no.	Pneumatic interface			
		VABA-...-X1-CB	VABA-...-X2-CB	VABA-...-X2-F1-CB	VABA-...-X2-F2-CB
CPX-FB13	195740	■	■	■	■
CPX-FB36	1912451	■	■	–	–
CPX-FB37	2735960	■	■	–	–
CPX-FB43	8110369	■	■	■	■
CPX-M-FB44	8110370	■	■	■	■

Ordering data

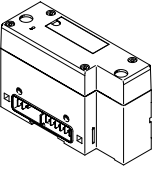
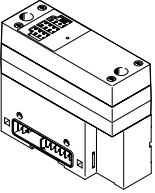
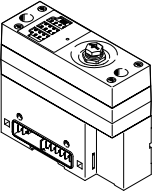
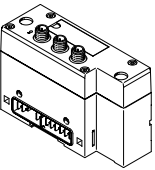
	Description	Product weight [g]	Part no.	Type	
Pneumatic interface without voltage zones					
	For polymer interlinking block	560	8082877	VABA-S6-1-X1-CB	
	For metal interlinking block	560	8082876	VABA-S6-1-X2-CB	
Pneumatic interface with voltage zones					
	For metal interlinking block	Division of the connected valves into up to 3 safe voltage zones	734	8068240	VABA-S6-1-X2-F1-CB
	For metal interlinking block	<ul style="list-style-type: none"> • Division of the connected valves into up to 2 safe voltage zones • 1 external safe voltage zone 	754	8068241	VABA-S6-1-X2-F2-CB
	For polymer interlinking block	<ul style="list-style-type: none"> • Division of the connected valves into up to 3 voltage zones • External power supply for each voltage zone 	580	8082879	VABA-S6-1-X1-3V-CB
	For metal interlinking block	<ul style="list-style-type: none"> • Division of the connected valves into up to 3 voltage zones • External power supply for each voltage zone 	580	8082878	VABA-S6-1-X2-3V-CB

Datasheet

Dimensions – Polymer interlinking module

Download CAD data → www.festo.com

With bus nodes and connection blocks

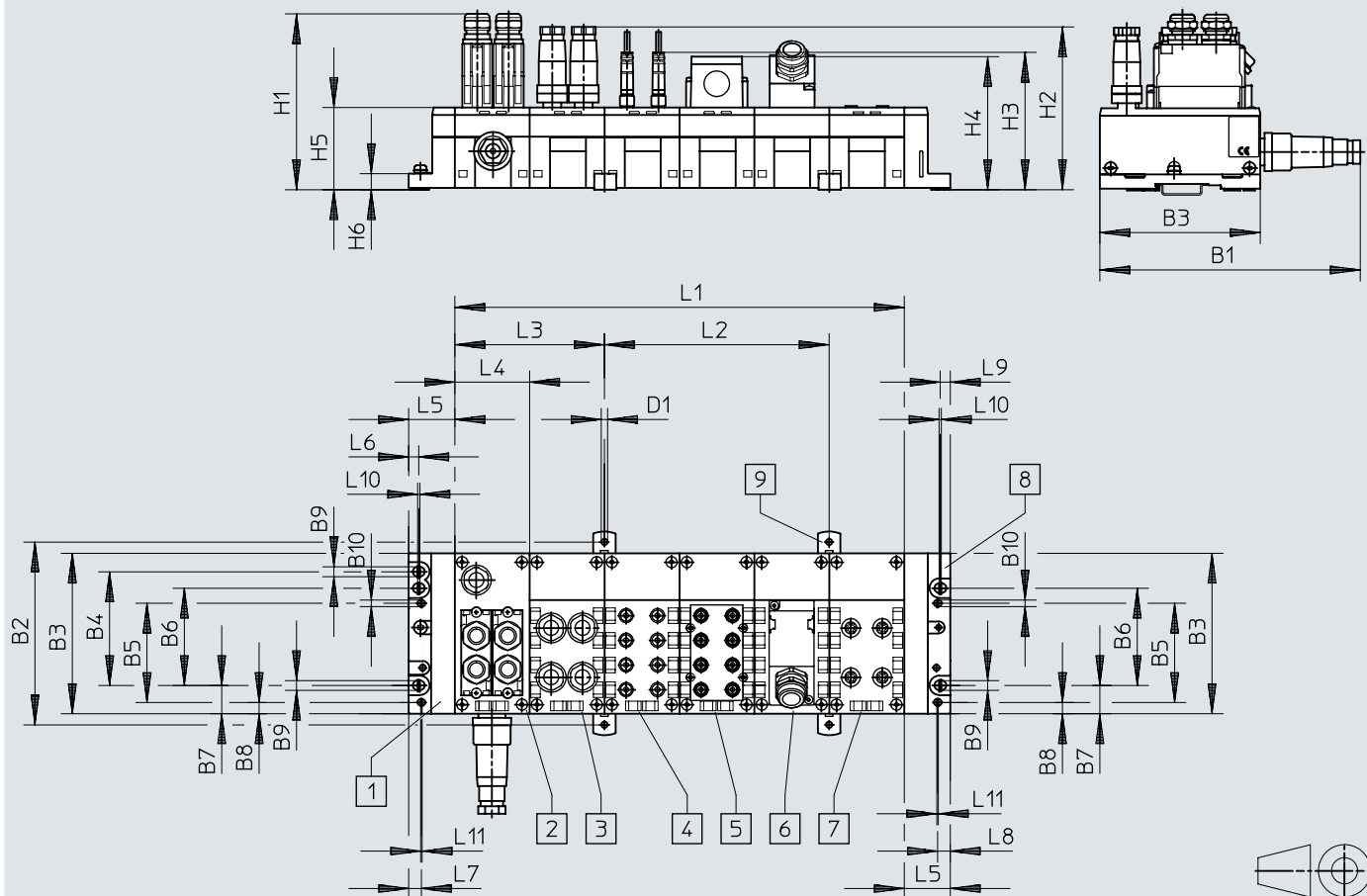

- | | | | |
|--|--|--|-------------------------|
| [1] Left end plate (earthing plate optional) | [5] Connection block CPX-AB-8-KL-4POL | [8] Right end plate | n Number of CPX modules |
| [2] Bus node | [6] Connection block CPX-AB-1-SUB-BU-25POL | [9] Mounting clip for wall mounting (required every 2 ... 3 connection blocks) | |
| [3] Connection block CPX-AB-4-M12-8POL | [7] Connection block CPX-AB-4-M12-8POL | | |
| [4] Connection block CPX-AB-8-M8-3POL | | | |

Type	B1	B2	B3	B4	B5	B6	B7	B8	B9	B10	D1 ∅
CPX-M	175	122.3	107.3	78	66.3	65	18.9	7.5	6.6	4.4	4.3

Type	H1	H2	H3	H4	H5	H6
CPX-M	118	110	92	89.1	55.1	10.8

Type	L1 ¹⁾	L2	L3 ²⁾	L4	L5 ³⁾	L6	L7	L8	L9	L10	L11
CPX-M	$n \times 50.1$	150.3	100.2	50.1	30.8	7.1	8.8	8.5	6.8	1.5	1

1) n = Number of CPX modules

Datasheet

Dimensions – Metal interlinking block

Download CAD data → www.festo.com

With bus nodes and connection blocks

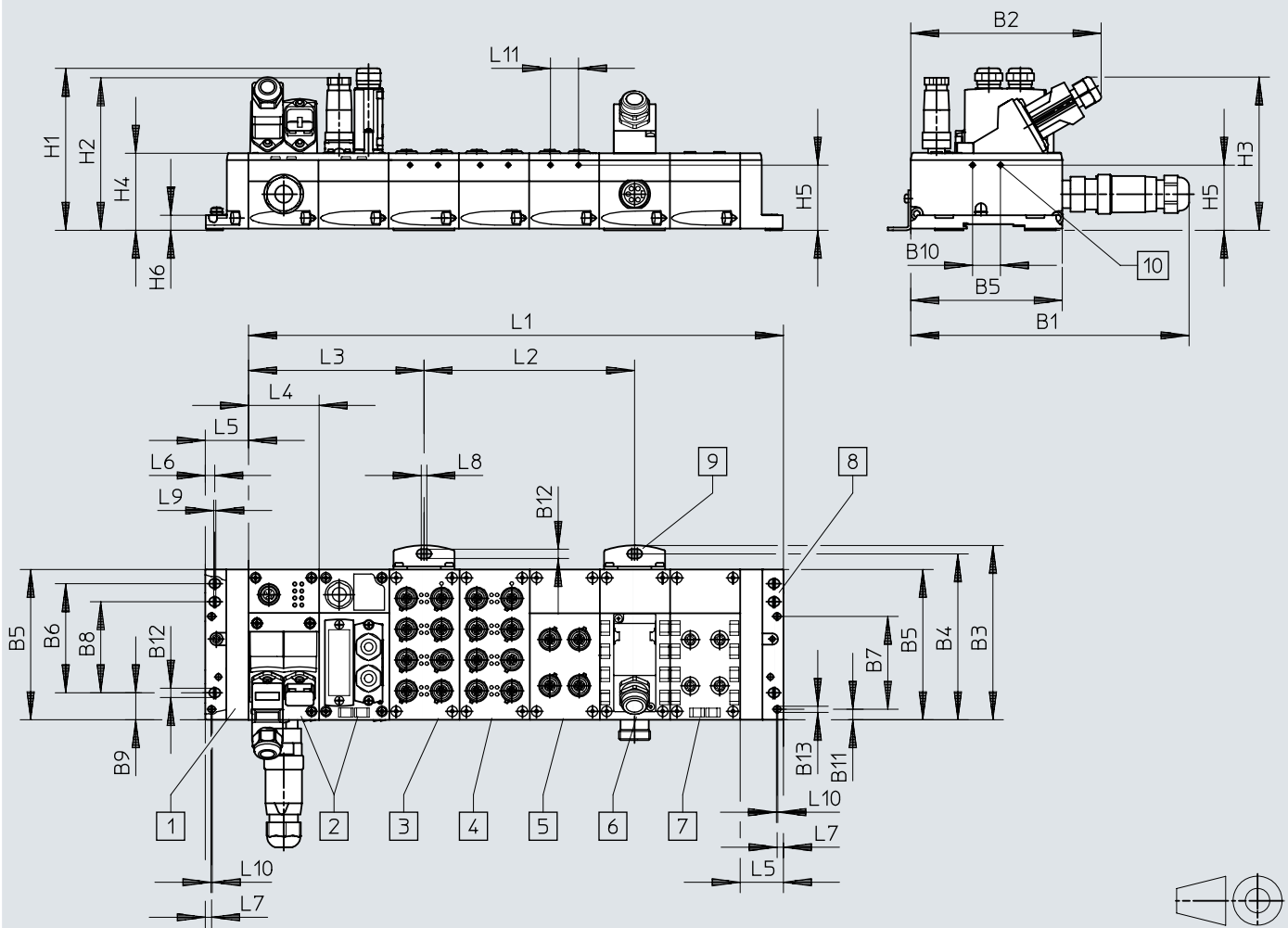

- [1] Left end plate
- [2] Bus node
- [3] Connection block CPX-M-AB-8-M12X2-5POL
- [4] Connection block CPX-M-AB-8-M12X2-5POL
- [5] Connection block CPX-M-AB-4-M12X2-5POL
- [6] Connection block CPX-AB-1-SUB-BU-25POL
- [7] Connection block CPX-AB-4-M12-8POL
- [8] Right end plate
- [9] Mounting bracket for wall mounting
- [10] Hole for self-tapping screw M2.5

Type	B1	B2	B3	B4	B5	B6	B7	B8	B9	B10	B11	B12	B13
CPX-M	199	136	124.9	118.85	108.1	77.95	66.3	65	19.25	20	7.9	6.6	4.4

Type	H1	H2	H3	H4	H5	H6
CPX-M	116	109	109.5	55.1	46.55	10.8

Type	L1 ¹⁾	L2	L3 ²⁾	L4	L5 ³⁾	L6	L7	L8	L9	L10	L11
CPX-M	$n \times 50.1 + 30.4$	150.3	125.25	50.1	30.4	6.75	4.5	4	1.5	1	20

1) n = Number of CPX modules

Datasheet

Dimensions

Download CAD data → www.festo.com

With bus node and valve terminal VTSA/VTSA-F/VTSA-F-CB

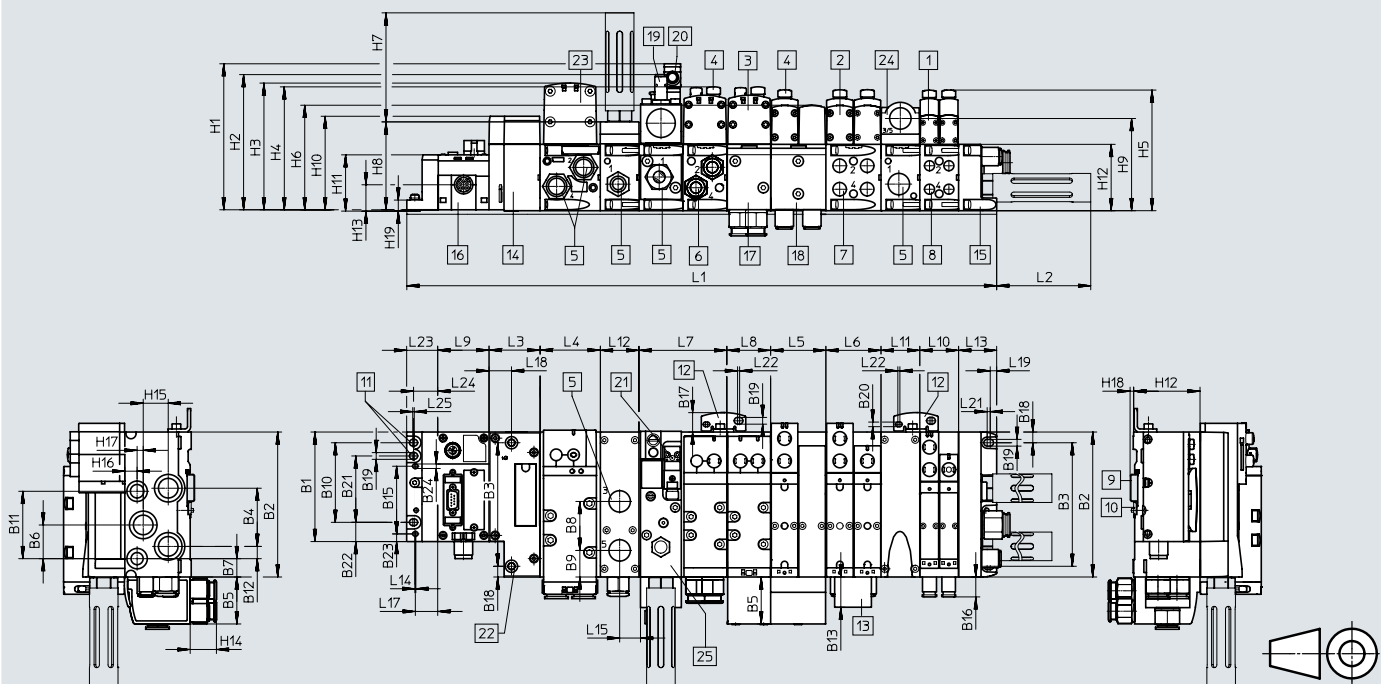

- [1] Solenoid valve, width 18 mm
- [2] Solenoid valve, width 26 mm
- [3] Solenoid valve, width 42 mm
- [4] Cover cap/manual override
- [5] Threaded connection G1/2
- [6] Threaded connection G3/8
- [7] Threaded connection G1/4
- [8] Threaded connection G1/8
- [9] DIN rail
- [10] DIN rail mounting
- [11] Mounting hole
- [12] Additional mounting bracket
- [13] Inscription label holder
- [14] Pneumatic interface CPX
- [15] End plate
- [16] CPX module/bus node
- [17] Angled connection plate 43 mm, G3/8
- [18] Angled connection plate 54 mm, G1/4
- [19] Proximity switch M12x1
- [20] Plug socket M12x1
- [21] Electrical connection to EN 175301-803, type C
- [22] Additional mounting bracket
- [23] Hole for additional mounting, diameter 6.4 2x
- [24] Solenoid valve, width 52 mm
- [25] Supply plate
- [26] Soft-start valve

Dim.	B1	B2	B3	B4	B5	B6	B7	B8	B9	B10	B11	B12	B13	B14	B16	B18	B19	B20	B21	B22	B23	B24
[mm]	107.3	142	121	57	46	33	18	48	26	78	66	12	29.6	23	19.5	10.5	6.6	4.5	65	18.9	7.5	4.4

Dim.	L2	L3	L4	L5	L6	L7	L8	L9	L10	L11	L12	L13	L14	L15	L17	L18	L19	L20	L21	L22
[mm]	92.4	50	n2x59	n01x54	54	n1x43	43	m x 50.1	n02x38	n x 38	38	37.3	1	20.5	22	22	6.3	5.5	3	2

Dim.	L23	L24	L25	H1	H2	H3	H4	H5	H6	H7	H8	H9	H10	H11	H12	H13	H14	H15	H16	H17	H18	H19
[mm]	30.4	23.7	1.5	143.9	133.3	125	121.3	118.2	103	106.8	87	90.3	92.9	55.1	65	25.8	25.7	24.5	12	6	3.5	10.8

Width	L1 ¹⁾
18 mm	30.4 + m x 50.1 + 50 + n02 x 38 + n x 38 + 37.3
26 mm	30.4 + m x 50.1 + 50 + n01 x 54 + n x 38 + 37.3
42 mm	30.4 + m x 50.1 + 50 + n1 x 43 + n x 38 + 37.3
52 mm	30.4 + m x 50.1 + 50 + n2 x 59 + n x 38 + 37.3
Combination of 18 mm, 26 mm, 42 mm and 52 mm	30.4 + m x 50.1 + 50 + n02 x 38 + n01 x 54 + n1 x 43 + n2 x 59 + n x 38 + 37.3

1) N02 Number of manifold sub-bases 38 mm
 N01 Number of manifold sub-bases 54 mm
 N1 Number of manifold sub-bases 43 mm
 N2 Number of manifold sub-bases 59 mm
 n Number of supply plates (only with end plate with pilot air selector)
 m Number of CPX modules

† Note: This product conforms to ISO 1179-1 and ISO 228-1.

Datasheet

Dimensions – With bus nodes and valve terminals MPA-S

Download CAD data → www.festo.com

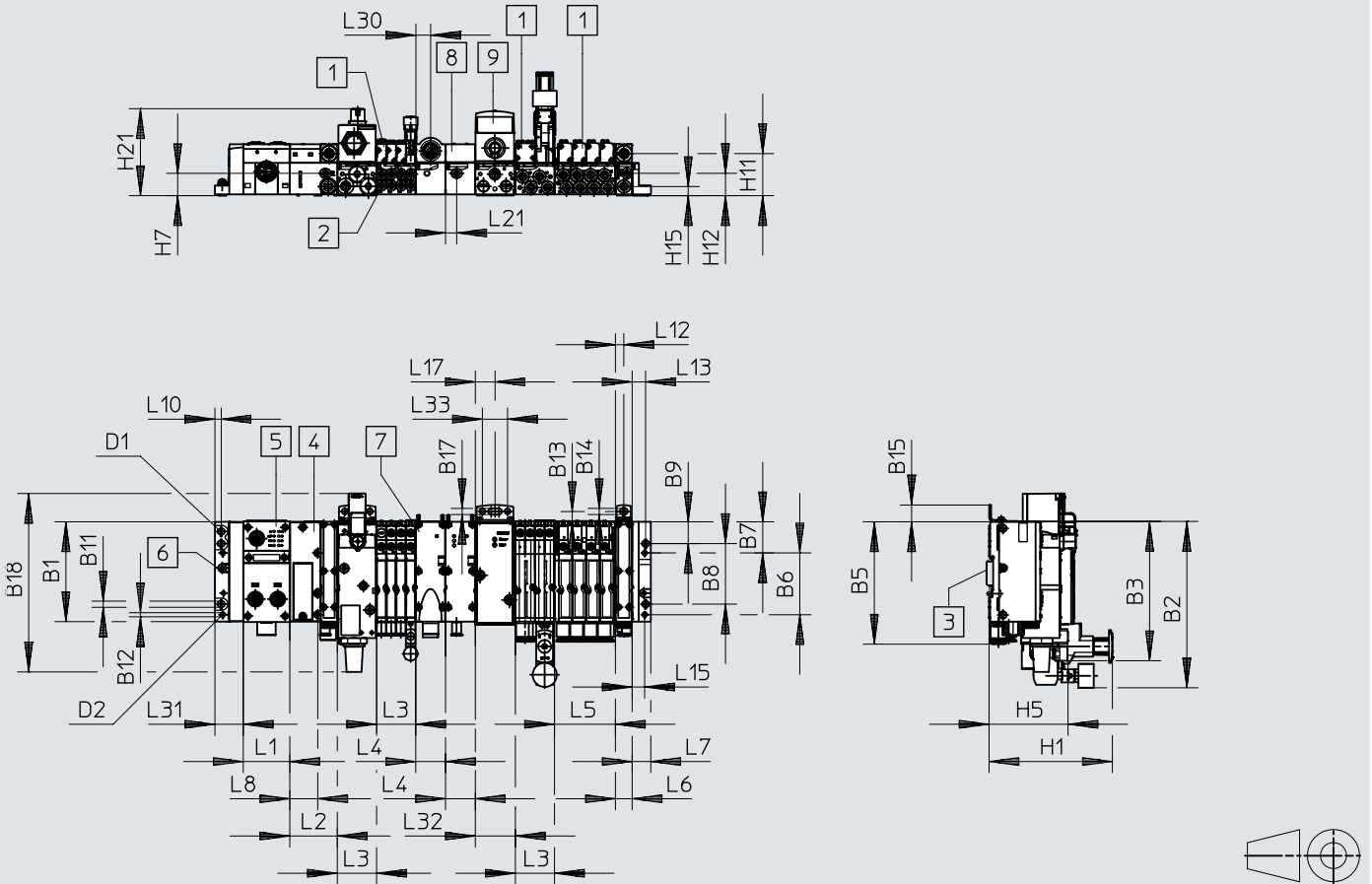

- [1] Solenoid valve
- [2] Working ports
- [3] DIN rail
- [4] Pneumatic interface VMPA□FB
- [5] CPX module
- [6] Earthing screw
- [7] Electrical supply plate
- [8] Pressure sensor
- [9] Proportional pressure regulator

Type	B1	B2	B3	B5	B6	B7	B8	B9	B11	B12	B13	B14	B15	B17
MPA-S	107.3	178	149.2	129	66.4	33.5	65	23.5	6.6	4.4	11	6.6	18	6.6

Type	D2	H1	H5	H7	H11	H12	H15	H21	L1 ¹⁾	L2	L3 ²⁾	L4	L5 ³⁾	L6
MPA-S	M4	132.3	84.9	23.9	45.1	23.9	9.8	93.4	m x 50.1	51.3	n x 42	32	o x 65.5	17.9

Type	L7	L8	L10	L12	L13	L14	L15	L17	L21	L30	L31	L32	L33
MPA-S	20	30	6.8	9	14.5	1.5	13.5	21	11.9	15.8	30.4	42	27

1) m = Number of CPX modules
 2) n = Number of sub-bases with 4 valve positions (width 10 mm) or 2 valve positions (width 20 mm)
 3) o = number of sub-bases with 4 valve positions (width 14 mm)

Datasheet

Dimensions – With bus nodes and valve terminals MPA-L

Download CAD data → www.festo.com

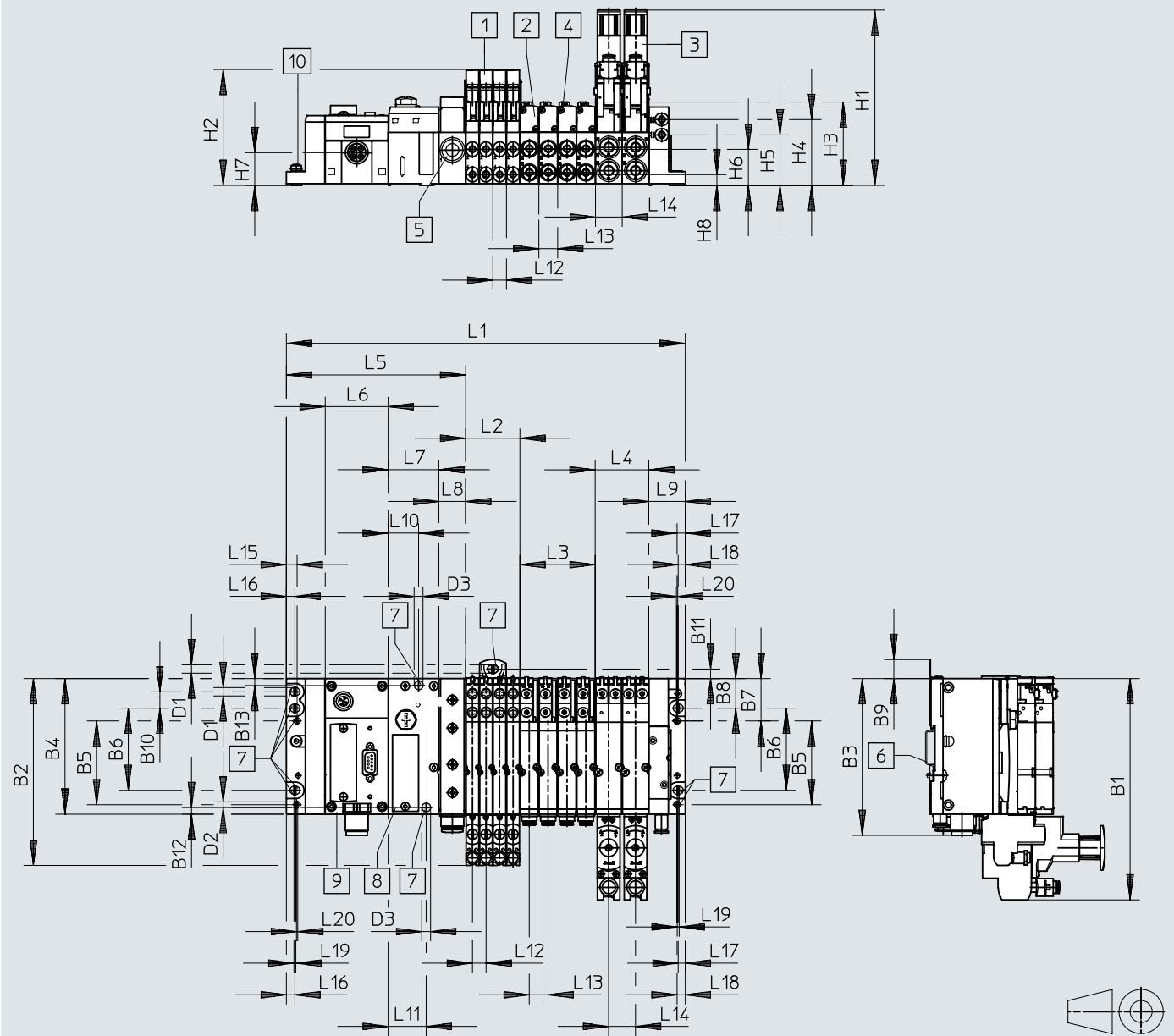

- [1] Solenoid valve VMPA1
- [2] Solenoid valve VMPA14
- [3] Solenoid valve VMPA2
- [4] Manual override
- [5] Supply module
- [6] DIN rail
- [7] Mounting holes
- [8] Pneumatic interface, CPX terminal
- [9] CPX module
- [10] Earthing screw

Type	L1 ¹⁾	L2 ¹⁾	L3 ¹⁾	L4 ¹⁾	L5	L6	L7	L8	L9
MPA-L	170.65 + L2 + L3 + L4	m x 10.7	n x 14.9	o x 21.2	142	50	40.1	21.2	28.8





Type	L10	L11	L12	L13	L14	L15	L16	L17	L18	L19	L20
MPA-L	24	30	10.7	14.9	21.2	8.5	6.75	5.55	6.5	1.5	1

Type	B1	B2	B3	B4	B5	B6	B7	B8	B9	B10	B11	B12	B13
MPA-L	175.1	147.8	124	107.3	66.3	65	33.5	23.45	15	12.95	7.5	5.25	5.5

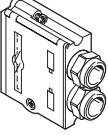

Type	D1	D2	D3	H1	H2	H3	H4	H5	H6	H7	H8
MPA-L	6.6	4.4	7	138.7	92.6	65.7	52	39.8	28.5	25.8	8.5

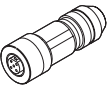
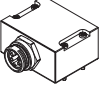
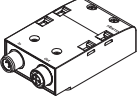
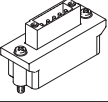
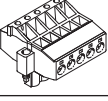
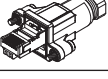
1) m, n, o = Number of sub-bases/valve positions (m = width 10 mm, n = width 14 mm, o = width 20 mm)

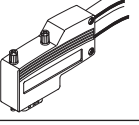
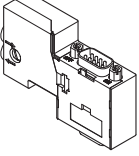



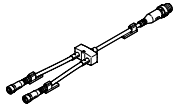

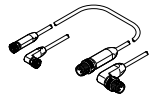
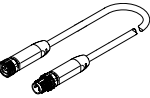
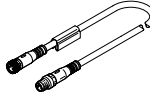
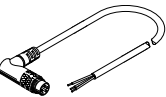
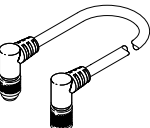
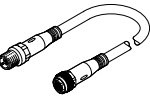
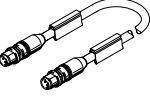
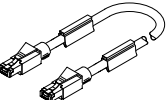

Accessories

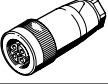
Ordering data – Accessories				Part no.	Type	
Designation						
Plug connectors and accessories						
	Sub-D plug for DeviceNet®/CANopen			532219	FBS-SUB-9-BU-2x5POL-B	
	Sub-D plug for PROFIBUS DP			532216	FBS-SUB-9-GS-DP-B	
	Sub-D plug for CC-Link®			532220	FBS-SUB-9-GS-2x4POL-B	
	Sub-D plug			534497	FBS-SUB-9-GS-1x9POL-B	
	Bus connection M12 adapter (B-coded) for PROFIBUS DP			533118	FBA-2-M12-5POL-RK	
	Micro style bus connection, 2xM12 for DeviceNet/CANopen			525632	FBA-2-M12-5POL	
	For micro style connection, M12	Socket	For cable Ø 3.8 ... 9 mm	8162291	NECB-M12G5-C2	
		Plug	For cable Ø 2.1 ... 7 mm	8162296	NECB-S-M12G5-C2	
	Bus connection M12x1, 4-pin (D-coded) for Ethernet			543109	NECU-M-S-D12G4-C2-ET	
	For FBA-2-M12-5POL-RK and CPX-AB-2-M12-RK-DP, M12x1, 5-pin, straight		Socket		1067905	NECU-M-B12G5-C2-PB
			Plug		1066354	NECU-M-S-B12G5-C2-PB
	Plug M12x1, 4-pin, straight, A-coded	Screw terminal	For cable Ø 2.1 ... 7 mm	8162294	NECB-S-M12G4-C2	
	Connection block, Sub-D socket 9-pin, plug 7/8" 5-pin for DeviceNet®			571052	CPX-AB-1-7/8-DN	
	Connection block M12 adapter (B-coded)	For PROFIBUS DP		541519	CPX-AB-2-M12-RK-DP	
	Open style bus connection for 5-pin terminal strip for DeviceNet/CANopen			525634	FBA-1-SL-5POL	
	Terminal strip for open style connection, 5-pin			525635	FBSD-KL-2x5POL	
	RJ45/plug			534494	FBS-RJ45-8-GS	
	Push-pull with locking mechanism against unintentional pulling		Plug RJ45, 8-pin	5195384	NECC-M-S-R3G8PP-HX-PN	
			SC-RJ connector to IEC 61754-24, 2-pin	5195381	NOCC-M-S-SCRJG2PP-C5-PN	
	Plug for CAN bus interface, electric axes Sub-D, 9-pin, without terminating resistor			533783	FBS-SUB-9-WS-CO-K	
	Sub-D socket with terminating resistor and programming interface		For CANopen	574588	NECU-S1W9-C2-ACO	
	Sub-D plug, straight, with terminating resistor and programming interface		For PROFIBUS	574589	NECU-S1W9-C2-APB	

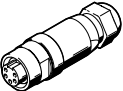
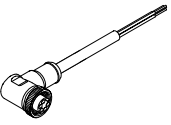

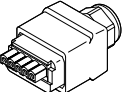

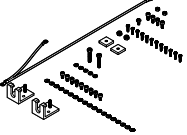
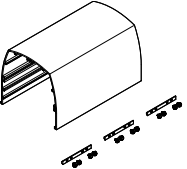
Accessories

Ordering data – Accessories				Part no.	Type	
Designation						
Distributor						
	Modular system for all types of sensor/actuator distributor			–	NEDY-... → Internet: nedy	
	Push-in T-connector	1x plug M8, 4-pin	2x socket M8, 3-pin	8005312	NEDY-L2R1-V1-M8G3-N-M8G4	
		1x plug M12, 4-pin	2x socket M8, 3-pin	8005311	NEDY-L2R1-V1-M8G3-N-M12G4	
			2x socket M12, 5-pin	8005310	NEDY-L2R1-V1-M12G5-N-M12G4	
Connecting cables						
	Modular system for a choice of connecting cables			–	NEBA-... → Internet: neba	
	1x socket M8, 3-pin	1x plug M8, 3-pin	0.5 m	★ 8078282	NEBA-M8G3-U-0.5-N-M8G3	
			1.0 m	★ 8078283	NEBA-M8G3-U-1-N-M8G3	
			2.5 m	★ 8078286	NEBA-M8G3-U-2.5-N-M8G3	
			5.0 m	★ 8078287	NEBA-M8G3-U-5-N-M8G3	
	Connecting cable M12-M12	5-pin	1.5 m	529044	KV-M12-M12-1.5	
	Connecting cable for CPX-CTEL, M12-M12, 5-pin, straight plug/straight socket		5 m	574321	NEBU-M12G5-E-5-Q8N-M12G5	
			7.5 m	574322	NEBU-M12G5-E-7.5-Q8N-M12G5	
			10 m	574323	NEBU-M12G5-E-10-Q8N-M12G5	
	Connecting cable M12-M12, 8-pin, Straight plug / straight socket		2.0 m	525617	KM12-8GD8GS-2-PU	
	Connecting cable M9, 5-pin, angled plug/open cable end 3-pin		2 m	563711	NEBC-M9W5-K-2-N-LE3	
			5 m	563712	NEBC-M9W5-K-5-N-LE3	
	Connecting cable M9, Angled plug / angled socket		0.25 m	540327	KVI-CP-3-WS-WD-0.25	
			0.5 m	540328	KVI-CP-3-WS-WD-0.5	
			2 m	540329	KVI-CP-3-WS-WD-2	
			5 m	540330	KVI-CP-3-WS-WD-5	
			8 m	540331	KVI-CP-3-WS-WD-8	
	Connecting cable M9, Straight plug / straight socket		2 m	540332	KVI-CP-3-GS-GD-2	
			5 m	540333	KVI-CP-3-GS-GD-5	
			8 m	540334	KVI-CP-3-GS-GD-8	
	Connecting cable, Straight plug, M12x1, 4-pin, D-coded	Straight plug, M12x1, 4-pin, D-coded	0.5 m	8040446	NEBC-D12G4-ES-0.5-S-D12G4-ET	
			1 m	8040447	NEBC-D12G4-ES-1-S-D12G4-ET	
			3 m	8040448	NEBC-D12G4-ES-3-S-D12G4-ET	
			5 m	8040449	NEBC-D12G4-ES-5-S-D12G4-ET	
			10 m	8040450	NEBC-D12G4-ES-10-S-D12G4-ET	
	Straight plug, RJ45, 8-pin			1 m	8040451	NEBC-D12G4-ES-1-S-R3G4-ET
				3 m	8040452	NEBC-D12G4-ES-3-S-R3G4-ET
				5 m	8040453	NEBC-D12G4-ES-5-S-R3G4-ET
				10 m	8040454	NEBC-D12G4-ES-10-S-R3G4-ET
				5 m	8040456	NEBC-LE4-ES-5-D12G4-ET
	Connecting cable, Straight plug, RJ45, 8-pin	Straight plug, RJ45, 8-pin	1 m	8040455	NEBC-R3G4-ES-1-S-R3G4-ET	



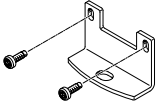
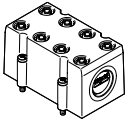
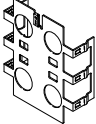
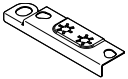
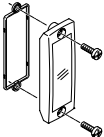
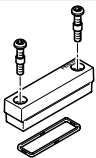

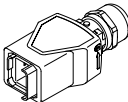
Accessories

Ordering data – Accessories		Part no.	Type
Designation			
Plug connectors and accessories – Power supply			
	Plug socket for mains connection M18, straight	For 1.5 mm ²	18493 NTSD-GD-9
		For 2.5 mm ²	18526 NTSD-GD-13,5
	Plug socket for mains connection M18, angled	For 1.5 mm ²	18527 NTSD-WD-9
		For 2.5 mm ²	533119 NTSD-WD-11
	Power supply socket, straight	7/8" connection, 5-pin	543107 NECU-G78G5-C2
		7/8" connection, 4-pin	543108 NECU-G78G4-C2
	Power supply socket 7/8", 5-pin, angled socket/open cable end, 5-core	2 m	573855 NEBU-G78W5-K-2-N-LE5
	Power supply socket M12x1, L-coded, straight	5-pin	8166793 NECL-L12G5-C2-Q10
	Power supply plug M12x1, L-coded, straight	5-pin	8166791 NECL-S-L12G5-C2-Q10
	Power supply socket M12x1, L-coded, angled	5-pin	8166794 NECL-L12W5-C2-Q10
	Power supply plug M12x1, L-coded, angled	5-pin	8166792 NECL-S-L12W5-C2-Q10
	Push-pull power supply socket, plug pattern PP, fulfils requirements to AIDA	5-pin	5195383 NECU-M-PPG5PP-C1-PN
	Straight plug, spring-loaded terminal, for left-hand end plate with system supply	7-pin	576319 NECU-L3G7-C1
Hood			
	Mounting rail for attaching the hood	1000 mm	572256 CAFC-X1-S
	Mounting kit for CPX hood		572257 CAFC-X1-BE
	Hood section for CPX terminal including mounting attachments for connecting several hood sections in series	200 mm	572258 CAFC-X1-GAL-200
		300 mm	572259 CAFC-X1-GAL-300
Screws			
	Screws for mounting the bus node/connection block on the polymer interlinking block	Bus node/metal connection block	550218 CPX-DPT-30X32-S-4X
	Screws for mounting the bus node/connection block on the metal interlinking block	Bus node/polymer connection block	550219 CPX-M-M3x22-4x
		Bus node/metal connection block	550216 CPX-M-M3x22-S-4x
	Screws for mounting an inscription label on the bus node CPX-M-FB45	Pack of 12	550222 CPX-M-M2.5X8-12X

Accessories

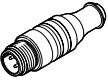
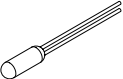
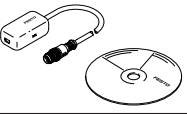
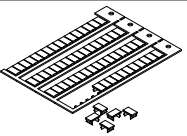
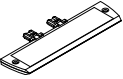
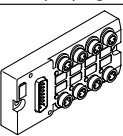
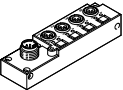
Ordering data – Accessories		Part no.	Type
Designation			
Mounting			
	Attachment for wall mounting (for long valve terminals, pack of 10)	Version for polymer manifold sub-bases	529040 CPX-BG-RW-10x
	Attachment for wall mounting, version for metal manifold sub-bases	2 mounting brackets, 4 screws	550217 CPX-M-BG-RW-2X
		1 mounting bracket, 2 screws	2721419 CPX-M-BG-VT-2X
Covers and attachments			
	Covering hood for CPX-AB-8-KL-4POL (IP65, IP67)		538219 AK-8KL
	<ul style="list-style-type: none"> • 8 cable through-feeds M9 • 1 cable through-feed for multi-pin plug Fittings kit		538220 VG-K-M9
	Screening plate for M12 connections		526184 CPX-AB-S-4-M12
	Earthing element (pack of 5), for right/left end plate (polymer interlinking blocks)		538892 CPX-EPFE-EV
	Inspection cover, transparent		533334 AK-SUB-9/15-B
	Transparent cover for the DIL switches		548757 CPX-AK-P
	Cover for DIL switches		548754 CPX-M-AK-M
	Cover for RJ45 connection		534496 AK-RJ45
	Cover cap for RJ45 push-pull connection		8090740 NEAC-M-S-BD-R3SCPP
	Cover cap for bus connection		2873540 CPX-M-AK-D
	Cover cap for sealing unused connections (pack of 10)	For M8 connections	177672 ISK-M8
		For M12 connections	165592 ISK-M12

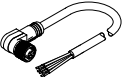
Accessories

Ordering data – Accessories		Part no.	Type	
Designation				
Function blocks				
	Terminating resistor, M12, B-coded for PROFIBUS	1072128	CACR-S-B12G5-220-PB	
	PT1000 temperature sensor for cold junction compensation	553596	CPX-W-PT1000	
	Adapter M12, 5-pin to mini USB socket, and controller software	547432	NEFC-M12G5-0.3-U1G5	
Inscription labels				
	Inscription labels 6x10 mm, 64 pieces, in a frame	18576	IBS-6x10	
	Inscription label holder for connection block	536593	CPX-ST-1	
Multi-pin plug distributor				
	Sub-D plug, 15-pin	8x socket M8, 3-pin	177669	MPV-E/A08-M8
		12x socket M8, 3-pin	177670	MPV-E/A12-M8
	Plug M12, 8-pin	4x socket M8, 3-pin	574586	NEDU-L4R1-M8G3L-M12G8
		6x socket M8, 3-pin	574587	NEDU-L6R1-M8G3L-M12G8
Connecting cable for multi-pin plug distributor				
	Sub-D socket, 15-pin Open cable end, 15-core	5 m	177673	KMPV-SUB-D-15-5
		10 m	177674	KMPV-SUB-D-15-10
	Angled socket, M12, 8-pin, Open cable end, 8-core	Length: 2 m	542256	NEBU-M12W8-K-2-N-LE8
		Length: 5 m	542257	NEBU-M12W8-K-5-N-LE8
		Length: 10 m	570007	NEBU-M12W8-K-10-N-LE8
	Straight socket, M12, 8-pin, Open cable end, 8-core	Length: 2 m	525616	SIM-M12-8GD-2-PU
		Length: 5 m	525618	SIM-M12-8GD-5-PU
		Length: 10 m	570008	SIM-M12-8GD-10-PU