

Bernoulli grippers OGGB

FESTO

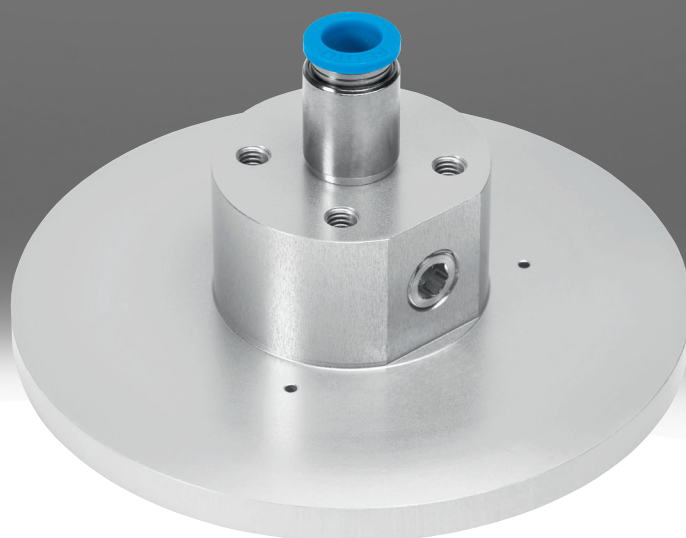

Characteristics

At a glance

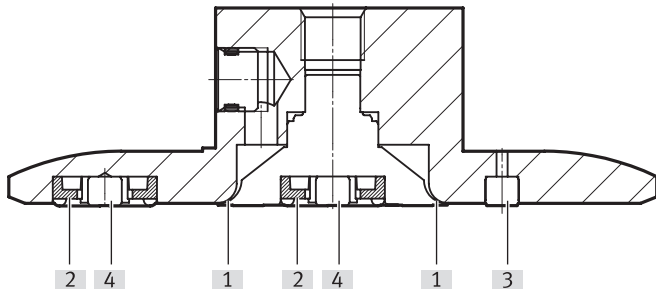

The Bernoulli-gripper OGGB is suitable for transporting thin, extremely sensitive and brittle workpieces. By generating a vacuum according to the Bernoulli principle, it is possible to grip a wide variety of workpieces gently and almost without any contact.

The incoming compressed air flows radially through the gripper and flows back out between the workpiece and the gripper surface. The air is routed through a very thin gap [1] between the gripper body and the core of the gripper, thus greatly accelerating the air. The high outflow speeds generate a vacuum between the gripper and the workpiece.

Applications:

- Photovoltaics (solar cell and wafer transport)
- Thin film solutions
- Film transport
- Flat panel
- Thin glass panes
- Electronic boards
- Flexible parts with large surface areas
- Air-permeable workpieces
- Separation of thin and porous materials
- Workpieces with textured surfaces

Note: Complete coverage with the gripper is recommended when handling thin, delicate workpieces (e.g. films).

Number of connections

Each gripper has two connection options for the compressed air: one connection at the top and an alternative connection on the side. The plug screw included is used to seal unused connections and is pre-assembled on the side as standard.

Stop

The gripper is available in three sizes. The spacers are available in two different materials for each size.

[] Standard

With the first version, all the spacers (ring shape [2] and knobs [3]) are made from POM.

[Q] For high lateral forces

The second version has ring-shaped spacers [2] made of POM and knobs ([3] and [4]) made of NBR. This second version can absorb higher lateral forces than the POM version, and the spacers in NBR can also be replaced if they wear out.

Type code

001	Series	
OGGB	Bernoulli grippers	

002	Suction cup size	
60	60 mm diameter	
100	100 mm diameter	
140	140 mm diameter	

003	Pneumatic connection	
G18	G1/8	

004	Number of connections	
2	2 connections	

005	Stop	
	Standard	
Q	For high lateral forces	

Datasheet

General technical data

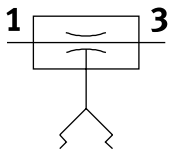

Gripper diameter	60	100	140
Pneumatic connection	G1/8		
alternative connections	G1/8		
Position of connection	On top/at side		
Type of mounting	Via female thread		
Mounting position	optional		

Operating and environmental conditions

Operating pressure	0 ... 6 bar
Nominal operating pressure	1 bar
Operating medium	Compressed air to ISO 8573-1:2010 [7:4:4]
Note on operating and pilot medium	Lubricated operation not possible
Ambient temperature	0 ... 60°C
Media temperature	0 ... 60°C
Corrosion resistance class CRC ¹⁾	2 - Moderate corrosion stress

1) More information www.festo.com/x/topic/crc

Performance data

Stop	For high lateral forces			Standard		
Gripper diameter	60 mm	100 mm	140 mm	60 mm	100 mm	140 mm
Air consumption at nominal operating pressure	110 l/min					
Holding force at nominal operating pressure	7 N	6 N		10 N	7 N	
Lateral force at nominal operating pressure	15 N	12 N		1 N		
Sound pressure level at nominal operating pressure	65 dB(A)					
Sound level at nominal operating pressure	78 dB(A)					

Materials

Material housing	Wrought aluminium alloy, Anodised
Material spacer	NBR, POM
Note on materials	RoHS-compliant
LABS (PWS) conformity	VDMA24364-B2-L

Datasheet

Holding force F as a function of operating pressure p_1

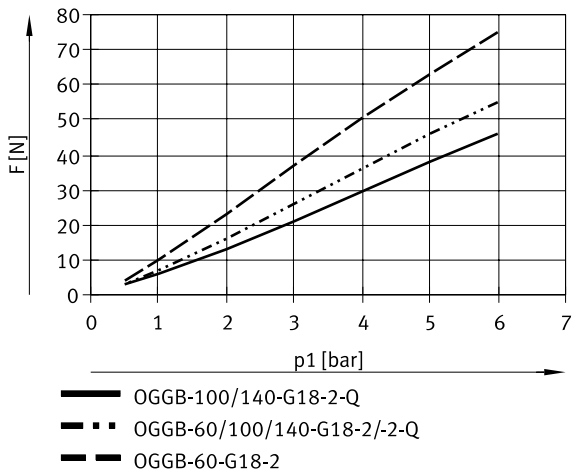

Air consumption q_n as a function of operating pressure p_1

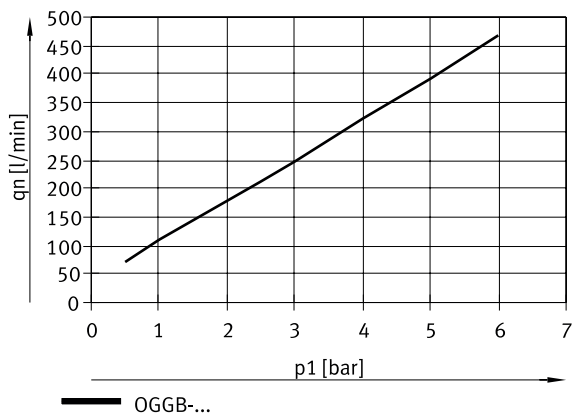

Dimensions

Dimensions – Bernoulli gripper OGGB

Download CAD data → www.festo.com

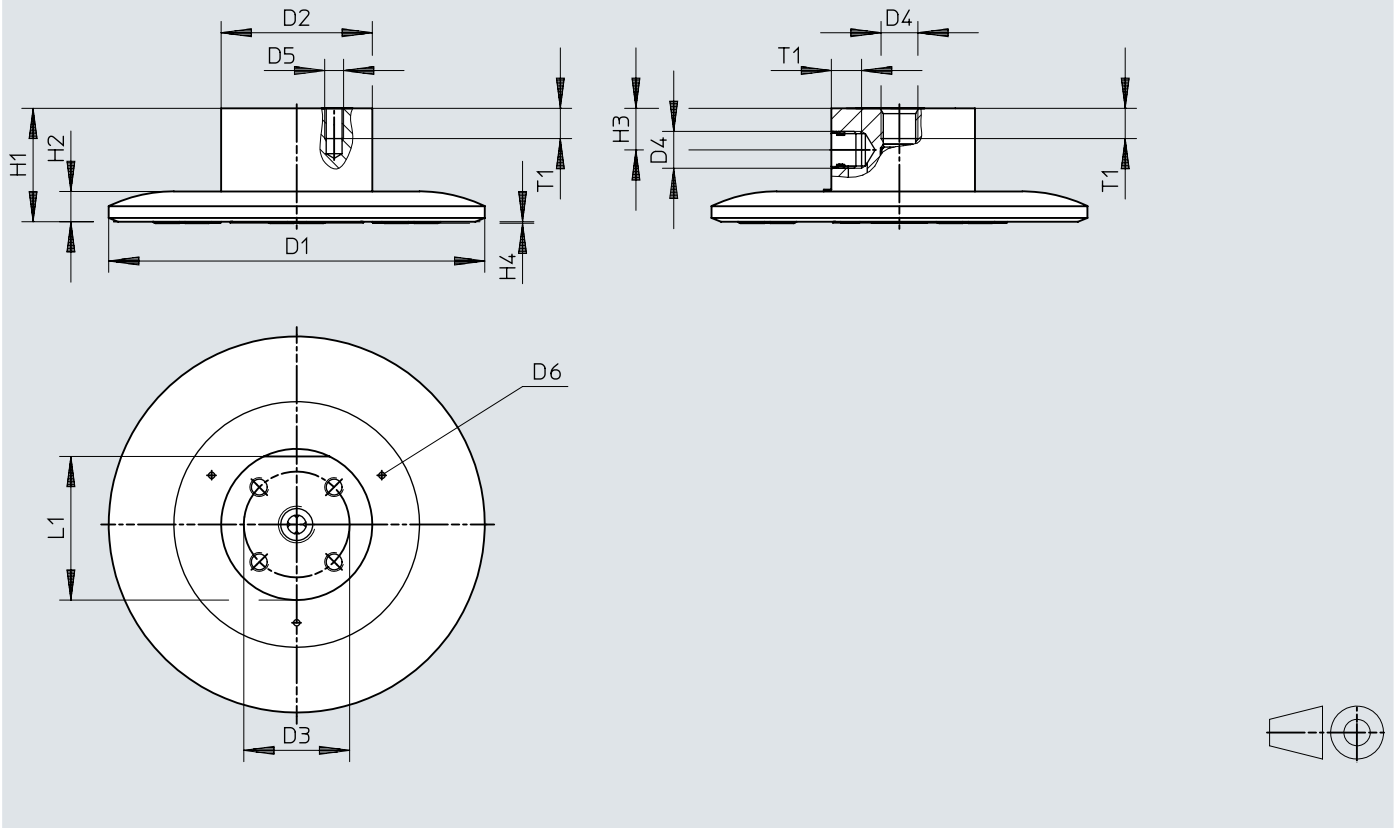

	D1 ∅	D2 ∅	D3 ∅	D4 ∅	D5	D6 ∅	H1	H2	H3	H4	L1	T1
OGGB-60	59,5	40	28	G1/8	M5	1,7	30	8	11	0,4	38	8
OGGB-100	99,5											
OGGB-140	139,5											

Ordering data

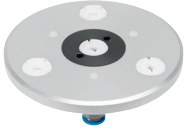
Ordering data – Standard					
	Pneumatic connection	Gripper diameter	Product weight	Part no.	Type
	G1/8	60 mm	119 g	574563	OGGB-60-G18-2
		100 mm	210 g	574565	OGGB-100-G18-2
		140 mm	348 g	574567	OGGB-140-G18-2

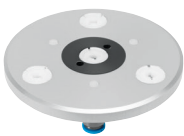
Ordering data – For high lateral forces					
	Pneumatic connection	Gripper diameter	Product weight	Part no.	Type
	G1/8	60 mm	119 g	574564	OGGB-60-G18-2-Q
		100 mm	210 g	574566	OGGB-100-G18-2-Q
		140 mm	348 g	574568	OGGB-140-G18-2-Q