

Round cylinders DSNU-S

FESTO



Festo core product range
Covers 80% of your automation tasks

Worldwide:

Always in stock

Superb:

Festo quality at an attractive price

Easy:

Simplified procurement and warehousing

★ Generally ready for shipping ex works in 24 hours

In stock at 13 Service Centres worldwide

More than 2200 products

★ Generally ready for shipping ex works in 5 days

Assembled for you at 4 Service Centres worldwide

Up to 6×10^{12} variants per product family

Just look
for the
star!

Key features

At a glance

DSNU-S-8 ... 16

- Cylinder barrel made of stainless steel
- Short end cap made of wrought aluminium alloy
- Space-saving



DSNU-S-20 ... 25

- Cylinder barrel made of stainless steel
- End cap made of wrought aluminium alloy with short thread
- Space-saving



Space-saving mounting

- Diameter reduced by up to 40%
- Overall length up to 3.5 cm shorter



Cushioning types

Cushioning P

Mode of operation

- The drive has elastic polymer flexible end-position cushioning

Application

- Small loads
- Low speeds
- Low impact energies

Advantages

- No adjustment required
- Saves time

Cushioning PPS

- The drive has self-adjusting end-position cushioning

- Small to medium loads
- Low to medium speeds
- Medium impact energies

- No adjustment required
- Saves time
- Powerful

Peripherals overview

DSNU-S...

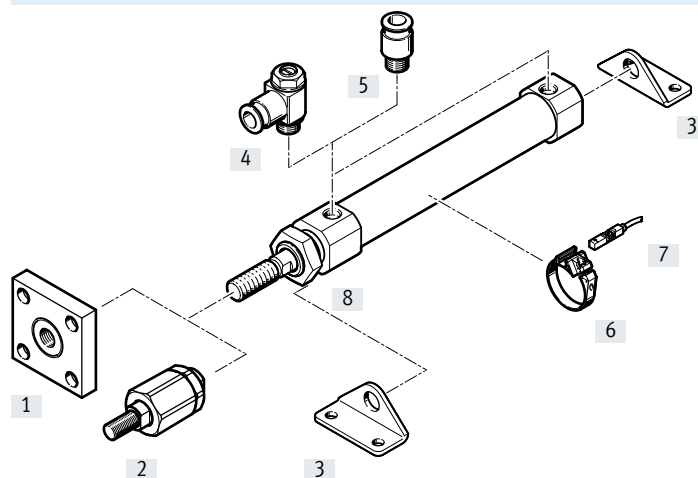

Mounting attachments and accessories		Piston \varnothing	Description	→ Page/ Internet
[1]	Coupling piece KSG	12 ... 25	To compensate for radial deviations	20
[2]	Self-aligning rod coupler FK	8 ... 25	To compensate for radial and angular deviations	20
[3]	Foot mounting HBN-S	8 ... 25	For bearing or end caps	19
[4]	One-way flow control valve GRLA/GRLZ	8 ... 25	For regulating speed	22
[5]	Push-in fitting QS	8 ... 25	For connecting tubing with standard O.D.	qs
[6]	Mounting kit SMBR-8	12 ... 25	For proximity switch SME/SMT-8	21
[7]	Proximity switch SME/SMT-8	8 ... 25	For position sensing	21
[8]	Hex nut MSK	16 ... 25	For mounting the cylinder	20

Product range overview

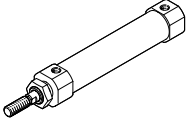
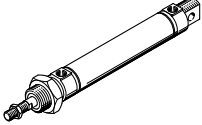
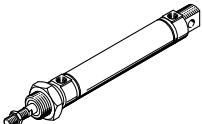
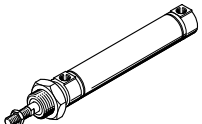
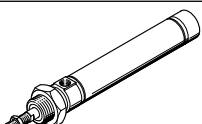
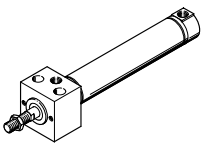
Function	Design	Piston \varnothing [mm]	Stroke [mm]	Variable stroke ¹⁾ [mm]	Piston rod					
					Through S2	Extended K8	Male thread			Female thread K3
							Extended K2	Shortened K6	Custom thread K5	
Double-acting	DSNU-S-... – Space-saving									
		8	10, 15, 20, 25, 30, 40, 50, 60, 80, 100	1 ... 100	-	-	-	-	-	-
		12	10, 15, 20, 25, 30, 40, 50, 60, 80, 100, 125, 150	1 ... 150	-	-	-	-	-	-
		16	10, 15, 20, 25, 30, 40, 50, 60, 80, 100, 125, 150, 200	1 ... 200	-	-	-	-	-	-
		20								
		25								
	DSNU-... – Cylinder barrel made of stainless steel									
	8, 10	10, 15, 20, 25, 30, 35, 40, 50, 60, 70, 80, 100, 125, 150, 160, 200, 250, 300, 320, 400, 500	1 ... 100 1 ... 200 1 ... 320 1 ... 500	■	■	■	■	■	■	
	12, 16							from \varnothing 25	from \varnothing 20	
	20									
	25									
	32, 40, 50, 63	25, 40, 50, 80, 100, 125, 160, 200, 250, 320	1 ... 500							
DSNU-Q-... – Protected against rotation										
	12, 16	-	5 ... 160	■	■	■	■	■	■	
	20	-	5 ... 200							
	25	-	5 ... 250							
	32	-	5 ... 300							
	40, 50	-	5 ... 400					from \varnothing 25	from \varnothing 20	
	63	-	5 ... 500							
DSNU-MQ-... – Lateral supply port, short end cap										
	8, 10	-	1 ... 100	-	■	■	■	■	■	
	12, 16	-	1 ... 200							
	20	-	1 ... 320							
	25	-	1 ... 500							
	32, 40, 50, 63	-	1 ... 500							
DSNU-MA-... – Axial supply port, short end cap										
	8, 10	-	1 ... 100	-	■	■	■	■	■	
	12, 16	-	1 ... 200							
	20	-	1 ... 320							
	25	-	1 ... 500							
	32, 40, 50	-	1 ... 500							
	63	-	1 ... 500							
DSNU-MH-... – Direct mounting										
	8, 10	-	1 ... 100	■	■	■	■	■	■	
	12, 16	-	1 ... 200							
	20	-	1 ... 320							
	25	-	1 ... 500							
	32, 40, 50	-	1 ... 500							
	63	-	1 ... 500							

1) Cylinders with position sensing require a minimum stroke of 10 mm to ensure reliable sensing

Product range overview

Piston Ø	Cushioning			Position sensing	Clamping unit	Heat-resistant seal	Slow speed (constant motion)	Low friction	Corrosion protection	Dust protection (wiper seal)	Metal scraper	→ Page/ Internet
	Fixed	Adjustable	Self-adjusting									
	P	PPV ²⁾	PPS	A	KP	S6	S10	S11	R3	R8	A6	
DSNU-S-... – Space-saving												
8 ... 25	■	-	■ from Ø 16	■	-	-	-	-	-	-	-	8
DSNU-... – Cylinder barrel made of stainless steel												
8 ... 63	■	■ from Ø 16	■ from Ø 16	■	■	■	■ from Ø 12	■ from Ø 12	■ from Ø 12	■ from Ø 32	■ from Ø 32	dsnu
DSNU-Q-... – Protected against rotation												
12 ... 63	■ Ø 12 and from Ø 32	■ from Ø 16	-	■	■	■ from Ø 32	-	-	■ from Ø 16	-	-	dsnu
DSNU-MQ-... – Lateral supply port												
8 ... 63	■	■ from Ø 16	■ from Ø 16	■	■	■	-	-	■	■ from Ø 32	■ from Ø 32	dsnu
DSNU-MA-... – Axial supply port												
8 ... 63	■ from Ø 32	-	-	■	■	■	-	-	■	-	■	dsnu
DSNU-MH-... – Direct mounting												
8 ... 63	■	■ from Ø 32	-	■	-	■	-	-	■	-	-	dsnu

2) In the modular product system from Ø 12 mm

Product range overview

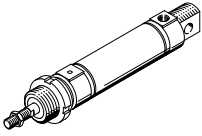
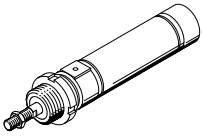
Function	Design	Piston \varnothing	Stroke	Variable stroke ¹⁾	Cushioning Fixed	Position sensing
		[mm]	[mm]	[mm]	P	A
Single-acting	ESNU-... – With position sensing					
		8 ... 63	10, 25, 50	1 ... 50	■	■
Single-acting	ESNU-MA-... – Axial supply port					
		8 ... 63	–	1 ... 50	■	■

1) Cylinders with position sensing require a minimum stroke of 10 mm to ensure reliable sensing

Product range overview

Piston \varnothing	Piston rod					→ Page/ Internet
	Extended K8	Male thread			Female thread K3	
		Extended K2	Shortened K6	Custom thread K5		
ESNU-... – With position sensing						
8 ... 63	■	■	■	■	■	esnu
ESNU-MA-... – Axial supply port						
8 ... 63	■	■	■	■	■	esnu

Type codes

DSNU-S-...

001	Series	
DSNU	Round cylinder, double-acting, based on ISO 6432	

002	Design type	
S	Space-optimised	

003	Piston diameter	
8	8	
12	12	
16	16	
20	20	
25	25	

004	Stroke	
...	1 ... 200	

005	Cushioning	
P	Elastic cushioning rings/plates on both sides	
PPS	Pneumatic cushioning, self-adjusting at both ends	

006	Position sensing	
A	For proximity sensor	

Data sheet

P cushioning

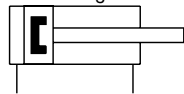

PPS cushioning

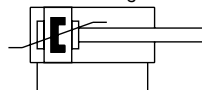

∅ - Diameter
8 ... 25 mm

— - Stroke length
1 ... 200 mm



General technical data

Piston ∅	8	12	16	20	25
Pneumatic connection	M5			G1/8	
Piston rod thread	M4	M6	M8		M10x1.25
Stroke ¹⁾ [mm]	10, 15, 20, 25, 30, 40, 50, 60, 80, 100	10, 15, 20, 25, 30, 40, 50, 60, 80, 100, 125, 150	10, 15, 20, 25, 30, 40, 50, 60, 80, 100, 125, 150, 200		
Design	Piston				
	Piston rod				
	Cylinder barrel				
Mode of operation	Double-acting				
Cushioning					
DSNU-S...-P	Elastic cushioning rings/plates at both ends				
DSNU-S...-PPS	-		Self-adjusting pneumatic end-position cushioning		
Cushioning length					
DSNU-S...-PPS [mm]	-		12	15	17
Position sensing	Via proximity switch				
Type of mounting	With accessories				
Mounting position	Any				

1) Cylinders with position sensing require a minimum stroke of 10 mm to ensure reliable sensing.

Operating and environmental conditions

Piston ∅	8	12	16	20	25
Operating medium	Compressed air to ISO 8573-1:2010 [7:4:4]				
Note on the operating/pilot medium	Lubricated operation possible (in which case lubricated operation will always be required)				
Operating pressure [bar]	1.5 ... 10	1 ... 10	0.8 ... 10	0.8 ... 10	0.6 ... 10
Ambient temperature ¹⁾ [°C]	-20 ... +80				
Corrosion resistance class CRC ²⁾	2				

1) Note operating range of proximity switches.

2) Corrosion resistance class CRC 2 to Festo standard FN 940070

Moderate corrosion stress. Indoor applications in which condensation can occur. External visible parts with primarily decorative surface requirements which are in direct contact with a normal industrial environment.

Data sheet

Forces [N] and impact energy [J]					
Piston \varnothing	8	12	16	20	25
Theoretical force at 6 bar, advancing	30.2	67.9	120.6	188.5	294.5
Theoretical force at 6 bar, retracting	22.6	50.9	103.7	158.3	247.4
Impact energy in the end positions ¹⁾	0.03	0.07	0.15	0.20	0.30

1) The values are reduced by approx. 50% at an ambient temperature of 80°C
Flow-controlled compressed air is recommended to protect against overload.

Weight [g]					
Piston \varnothing	8	12	16	20	25
Product weight with 0 mm stroke					
[P]	20.1	35.9	49	126.1	180
[PPS]	–	–	57.7	123.5	173.2
Additional weight per 10 mm stroke	2.4	4	4.6	7.2	11
Moving mass with 0 mm stroke					
	6.3	16.17	18.52	37.44	63.93
Moving mass per 10 mm stroke	1	2	2	4	6

Materials

Sectional view

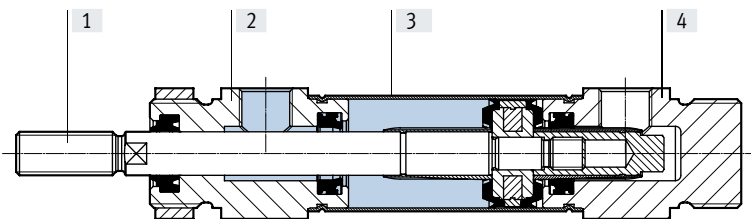

Round cylinder	8 ... 25
[1] Piston rod	High-alloy stainless steel
[2] Bearing cap	Wrought aluminium alloy
[3] Cylinder barrel	High-alloy stainless steel
[4] End cap	Wrought aluminium alloy
– Seals	TPE-U(PU)
Note on materials	RoHS-compliant

Data sheet

Max. lateral force F_q as a function of projection l

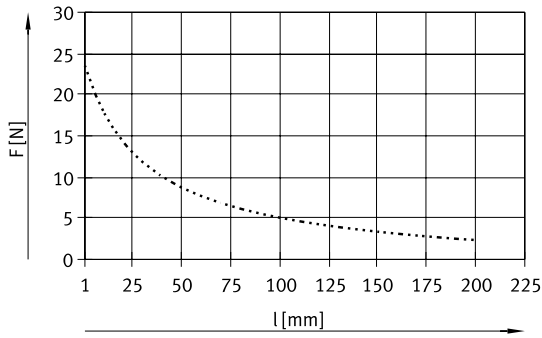
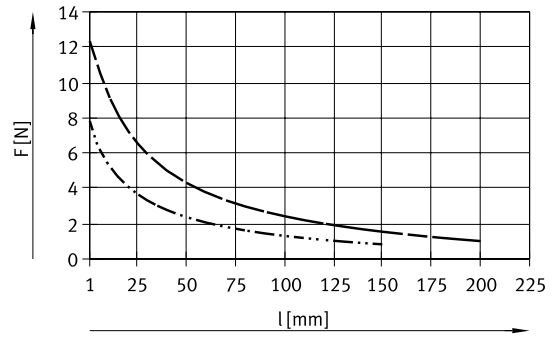
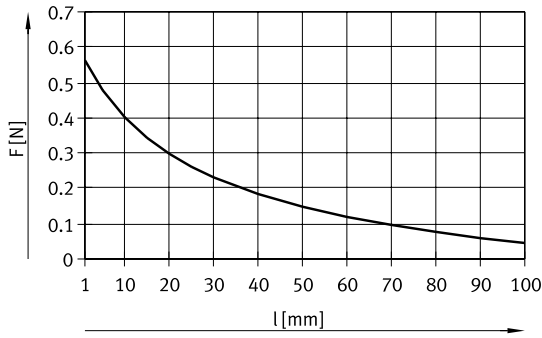
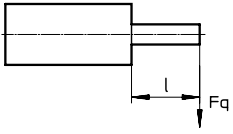

- DSNU-S-8
- · - · - · DSNU-S-12/16
- - - - - DSNU-S-20
- · · · · DSNU-S-25

Data sheet

Dimensions

Download CAD data → www.festo.com

DSNU-S-8

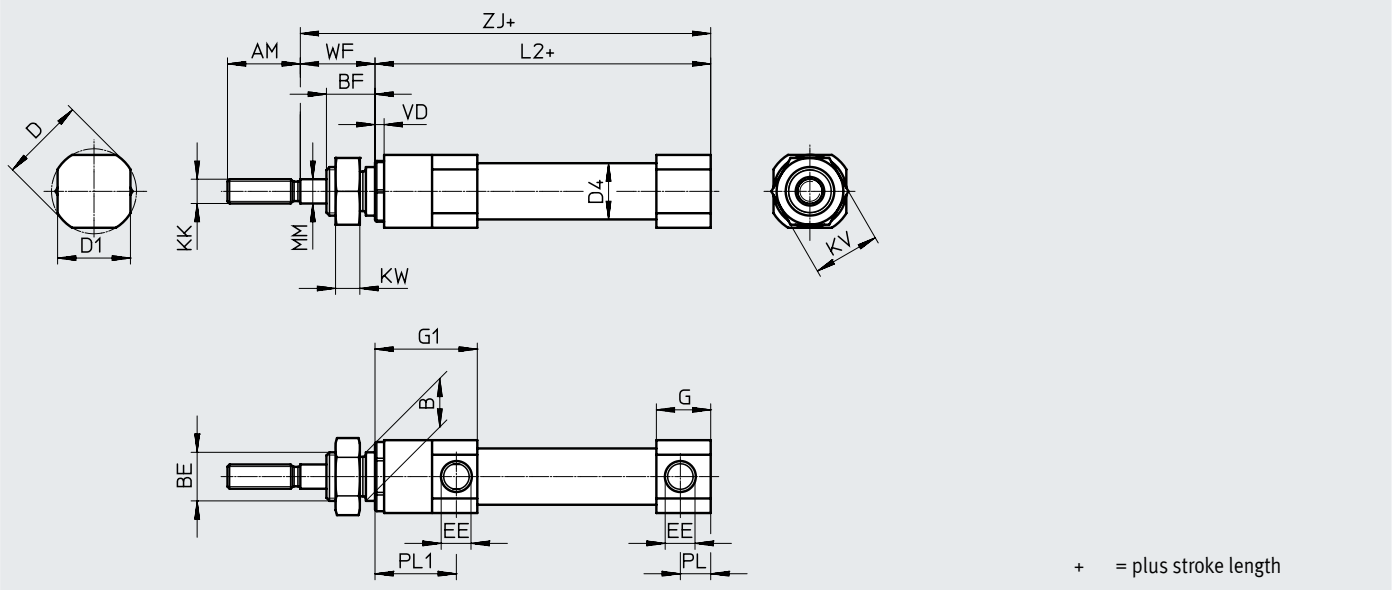

Data sheet

∅	AM	B	BE	BF	D ∅	D1 ∅	D4 ∅
[mm]		h8					
8	12	8	M8x1	8	14	12	9.3
∅	EE	G	G1	KK	KV	KW	L2+
[mm]							
8	M5	9	16.9	M4	11	4	45.4
∅	MM ∅	PL	PL1	VD	WF ±0.7	ZJ ±1	
[mm]							
8	4	5	13.4	1.5	11.9	57.7	

Data sheet

Dimensions

Download CAD data → www.festo.com

DSNU-S-12 ... 16

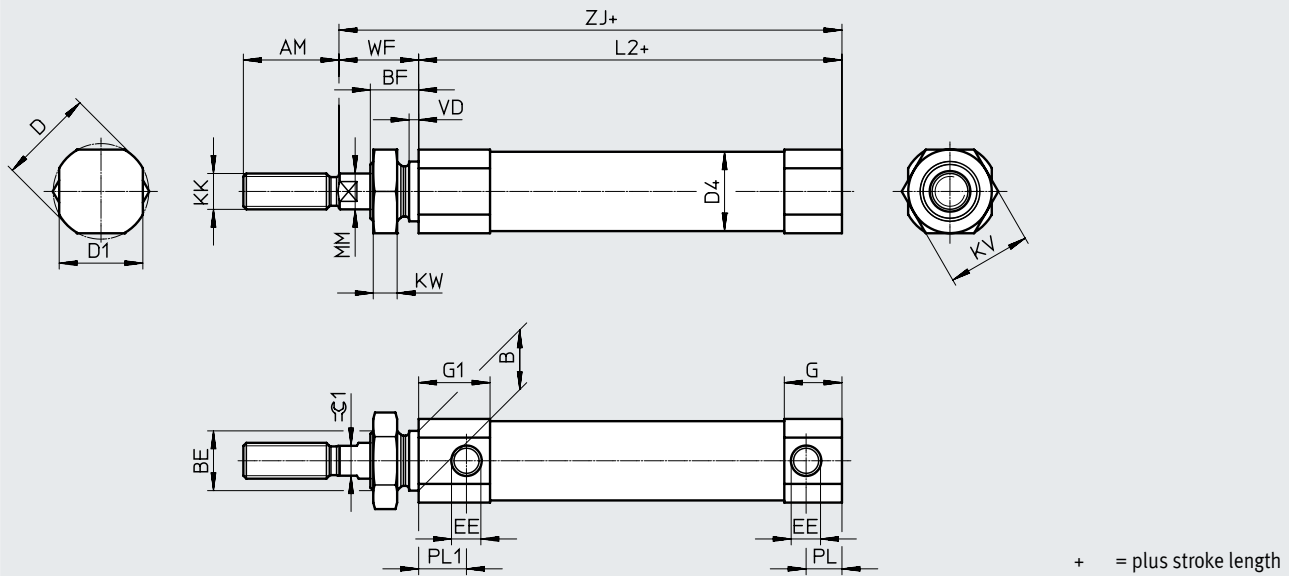

DSNU-S-20 ... 25

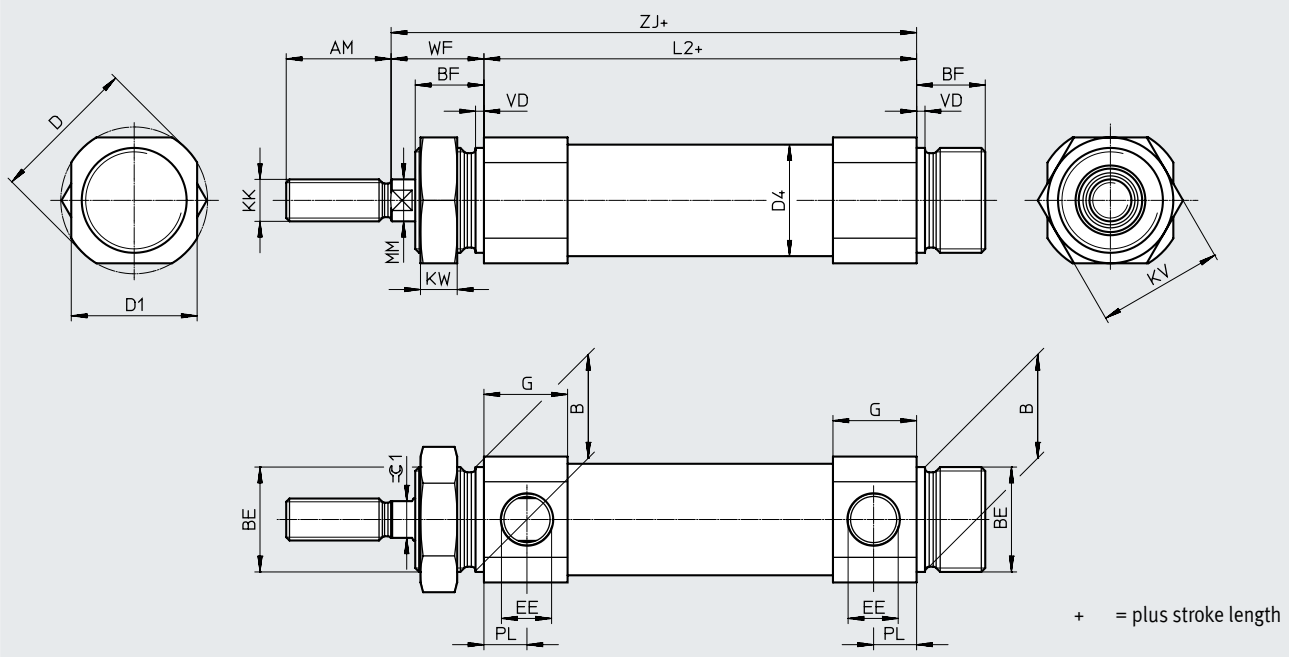

Data sheet

∅ [mm]	AM	B h8	BE	BF	D ∅	D1 ∅	D4 ∅	EE
12	16	10	M10x1	8	16	14	13.3	M5
16					20	18	17.3	
20	20	20	M20x1.5	13	28	24	21.3	G1/8
25	22				30	27	26.5	

∅ [mm]	G		G1	KK	KV	KW	L2+	
	DSNU-...-P	DSNU-...-PPS					DSNU-...-P	DSNU-...-PPS
12	9.7	–	12	M6	14	4	46	–
16	11.2	9.7	11.2				45.5	57
20	16	16	–	M8	24	7	57.6	57.6
25	16.8	16.8	–	M10x1.25			60.3	60.3

∅ [mm]	MM ∅	PL	PL1	VD	WF	ZJ ±1		⊕G1
						DSNU-...-P	DSNU-...-PPS	
12	6	6	8	1.5	13 ±0.7	59.3	–	5
16			7.5		12.9 ±0.75	58.8	70.3	
20	8	8.2	–	1.5	17.3 ±0.75	75.3	75.3	7
25	10	8.3	–	–	19.6 ±0.75	80.3	80.3	9

Data sheet

★ Core product range

Ordering data				PPS – Pneumatic cushioning, self-adjusting at both ends	
Piston ø [mm]	Stroke [mm]	P – Elastic cushioning rings/plates at both ends A – With position sensing		A – With position sensing	
		Part no.	Type	Part no.	Type
8	10	5205897	DSNU-S-8-10-P-A	–	
	15	5205898	DSNU-S-8-15-P-A	–	
	20	5205899	DSNU-S-8-20-P-A	–	
	25	5205900	DSNU-S-8-25-P-A	–	
	30	5205902	DSNU-S-8-30-P-A	–	
	40	5205903	DSNU-S-8-40-P-A	–	
	50	5205904	DSNU-S-8-50-P-A	–	
	60	5205905	DSNU-S-8-60-P-A	–	
	80	5205906	DSNU-S-8-80-P-A	–	
100	5205907	DSNU-S-8-100-P-A	–		
12	10	★ 5211896	DSNU-S-12-10-P-A	–	
	15	★ 5211897	DSNU-S-12-15-P-A	–	
	20	★ 5211898	DSNU-S-12-20-P-A	–	
	25	★ 5211899	DSNU-S-12-25-P-A	–	
	30	★ 5211900	DSNU-S-12-30-P-A	–	
	40	★ 5211901	DSNU-S-12-40-P-A	–	
	50	★ 5211903	DSNU-S-12-50-P-A	–	
	60	★ 5211904	DSNU-S-12-60-P-A	–	
	80	★ 5211905	DSNU-S-12-80-P-A	–	
	100	★ 5211906	DSNU-S-12-100-P-A	–	
	125	★ 5211908	DSNU-S-12-125-P-A	–	
	150	★ 5211909	DSNU-S-12-150-P-A	–	
16	10	★ 5216087	DSNU-S-16-10-P-A	–	
	15	★ 5216088	DSNU-S-16-15-P-A	–	
	20	★ 5216089	DSNU-S-16-20-P-A	–	
	25	★ 5216090	DSNU-S-16-25-P-A	★ 5217238	DSNU-S-16-25-PPS-A
	30	★ 5216091	DSNU-S-16-30-P-A	★ 5217239	DSNU-S-16-30-PPS-A
	40	★ 5216093	DSNU-S-16-40-P-A	★ 5217240	DSNU-S-16-40-PPS-A
	50	★ 5216094	DSNU-S-16-50-P-A	★ 5217241	DSNU-S-16-50-PPS-A
	60	★ 5216095	DSNU-S-16-60-P-A	★ 5217242	DSNU-S-16-60-PPS-A
	80	★ 5216096	DSNU-S-16-80-P-A	★ 5217243	DSNU-S-16-80-PPS-A
	100	★ 5216098	DSNU-S-16-100-P-A	★ 5217244	DSNU-S-16-100-PPS-A
	125	★ 5216099	DSNU-S-16-125-P-A	★ 5217245	DSNU-S-16-125-PPS-A
	150	★ 5216100	DSNU-S-16-150-P-A	★ 5217246	DSNU-S-16-150-PPS-A
	200	★ 5216101	DSNU-S-16-200-P-A	★ 5217248	DSNU-S-16-200-PPS-A
	20	10	★ 5224633	DSNU-S-20-10-P-A	–
15		★ 5224634	DSNU-S-20-15-P-A	–	
20		★ 5224635	DSNU-S-20-20-P-A	–	
25		★ 5224636	DSNU-S-20-25-P-A	★ 5225836	DSNU-S-20-25-PPS-A
30		★ 5224637	DSNU-S-20-30-P-A	★ 5225837	DSNU-S-20-30-PPS-A
40		★ 5224639	DSNU-S-20-40-P-A	★ 5225838	DSNU-S-20-40-PPS-A
50		★ 5224641	DSNU-S-20-50-P-A	★ 5225839	DSNU-S-20-50-PPS-A
60		★ 5224642	DSNU-S-20-60-P-A	★ 5225840	DSNU-S-20-60-PPS-A
80		★ 5224643	DSNU-S-20-80-P-A	★ 5225841	DSNU-S-20-80-PPS-A
100		★ 5224644	DSNU-S-20-100-P-A	★ 5225842	DSNU-S-20-100-PPS-A
125		★ 5224645	DSNU-S-20-125-P-A	★ 5225843	DSNU-S-20-125-PPS-A
150		★ 5224646	DSNU-S-20-150-P-A	★ 5225844	DSNU-S-20-150-PPS-A
200		★ 5224647	DSNU-S-20-200-P-A	★ 5225846	DSNU-S-20-200-PPS-A

Festo core product range



Generally ready for shipping ex works in 24 hours

Generally ready for shipping ex works in 5 days

Data sheet

★ Core product range

Ordering data					
Piston ø [mm]	Stroke [mm]	P – Elastic cushioning rings/plates at both ends A – With position sensing		PPS – Pneumatic cushioning, self-adjusting at both ends A – With position sensing	
		Part no.	Type	Part no.	Type
25	10	★ 5228227	DSNU-S-25-10-P-A		
	15	★ 5228228	DSNU-S-25-15-P-A		
	20	★ 5228229	DSNU-S-25-20-P-A		
	25	★ 5228230	DSNU-S-25-25-P-A	★ 5228452	DSNU-S-25-25-PPS-A
	30	★ 5228231	DSNU-S-25-30-P-A	★ 5228453	DSNU-S-25-30-PPS-A
	40	★ 5228232	DSNU-S-25-40-P-A	★ 5228454	DSNU-S-25-40-PPS-A
	50	★ 5228233	DSNU-S-25-50-P-A	★ 5228455	DSNU-S-25-50-PPS-A
	60	★ 5228234	DSNU-S-25-60-P-A	★ 5228456	DSNU-S-25-60-PPS-A
	80	★ 5228235	DSNU-S-25-80-P-A	★ 5228457	DSNU-S-25-80-PPS-A
	100	★ 5228236	DSNU-S-25-100-P-A	★ 5228458	DSNU-S-25-100-PPS-A
	125	★ 5228237	DSNU-S-25-125-P-A	★ 5228459	DSNU-S-25-125-PPS-A
	150	★ 5228238	DSNU-S-25-150-P-A	★ 5228460	DSNU-S-25-150-PPS-A
	200	★ 5228239	DSNU-S-25-200-P-A	★ 5228461	DSNU-S-25-200-PPS-A

Festo core product range



Generally ready for shipping ex works in 24 hours

Generally ready for shipping ex works in 5 days

Ordering data – Modular product system

Ordering table								
Size	8	12	16	20	25	Conditions	Code	Enter code
Module no.	8112002	8112003	8112004	8112005	8112006			
Function	Double-acting round cylinder						DSNU	DSNU
Design	Space-saving						-S	-S
Piston ø [mm]	8	12	16	20	25		-...	
Stroke [mm]	1 ... 100	1 ...150	1 ...200	1 ...200	1 ...200		-...	
Cushioning	Elastic cushioning rings/plates at both ends						-P	
	-		Pneumatic cushioning, self-adjusting at both ends				-PPS	
Position sensing	Via proximity switch						-A	-A

Accessories

Foot mounting HBN-S

Scope of delivery:

HBN-S-...x1: 1 foot

HBN-S-...x2: 2 feet and 1 nut

Material:

Galvanised steel

Free of copper and PTFE

RoHS-compliant

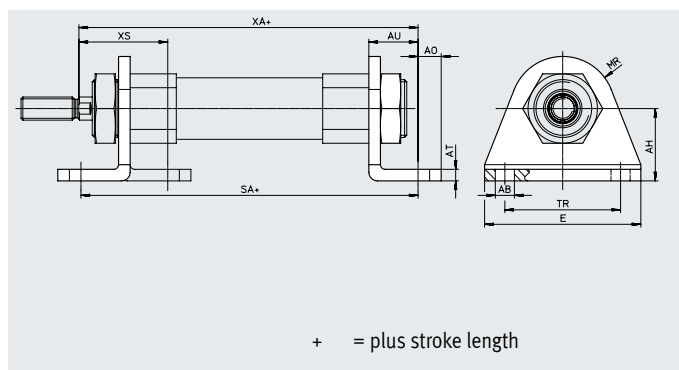

Dimensions and ordering data

For \varnothing [mm]	AB \varnothing	AH	AO	AT	AU ± 0.2	E	MR
8	4.5	10	5	2	11	35	7
12	5.5	15	6	3	14	42	10
16	5.5	15	6	3	14	42	10
20	6.6	25	8	4	17	54	18
25	6.6	25	8	4	17	54	18

For \varnothing [mm]	SA		TR ± 0.1	XA		XS
		DSNU-PPS			DSNU-PPS	
8	67.4	–	25	68.7	–	21.3
12	74	–	32	73.3	–	24.3
16	73.5	85	32	72.8	84.3	24.3
20	91.6	91.6	40	92.3	92.3	30.7
25	94.3	94.3	40	97.3	97.3	33

For \varnothing [mm]	Basic version CRC ¹⁾	Weight [g]	Part no.	Type
8, 10	1	12	★ 5407712	HBN-S-8x1
12, 16	1	30	★ 5407772	HBN-S-12/16x1
20, 25	1	77	★ 5407787	HBN-S-20/25x1
	1	165	★ 5407847	HBN-S-20/25x2

1) Corrosion resistance class CRC 1 to Festo standard FN 940070



Low corrosion stress. Dry indoor application or transport and storage protection. Also applies to parts behind covers, in the non-visible interior area, and parts which are covered in the application (e.g. drive trunnions).



Accessories

Ordering data – Piston rod attachments

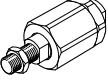
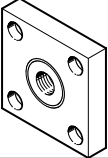
Data sheets → Internet: piston rod attachment

Designation	For ø	Part no.	Type
Self-aligning rod coupler FK			
	8	6528	FK-M4
	12	2061	FK-M6
	16		
	20	2062	FK-M8
	25	6140	FK-M10x1.25
Coupling piece KSG			
	12	-	
	16		
	20		
	25		
	Hex nut MSK		
	16	189007	MSK-M16X1.5
	20	★ 189009	MSK-M22X1.5
	25		

Festo core product range





Generally ready for shipping ex works in 24 hours

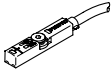
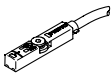

Generally ready for shipping ex works in 5 days

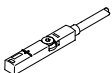
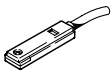
Accessories

Ordering data – Proximity switch for T-slot, magneto-resistive						Data sheets → Internet: smt
	Type of mounting	Switching output	Electrical connection	Cable length [m]	Part no.	Type
N/O contact						
	Inserted in the slot from above, flush with the cylinder profile, short design	PNP	Cable, 3-wire	2.5	★ 574335	SMT-8M-A-PS-24V-E-2.5-OE
			Plug M8x1, 3-pin	0.3	★ 574334	SMT-8M-A-PS-24V-E-0.3-M8D
		NPN	Plug M12x1, 3-pin	0.3	★ 574337	SMT-8M-A-PS-24V-E-0.3-M12
			Cable, 3-wire	2.5	★ 574338	SMT-8M-A-NS-24V-E-2.5-OE
			Plug M8x1, 3-pin	0.3	★ 574339	SMT-8M-A-NS-24V-E-0.3-M8D
N/C contact						
	Inserted in the slot from above, flush with the cylinder profile, short design	PNP	Cable, 3-wire	7.5	★ 574340	SMT-8M-A-PO-24V-E-7.5-OE

Ordering data – Proximity switch for T-slot, magnetic reed						Data sheets → Internet: sme
	Type of mounting	Switching output	Electrical connection	Cable length [m]	Part no.	Type
N/O contact						
	Inserted in the slot from above, flush with the cylinder profile	Contacting	Cable, 3-wire	2.5	★ 543862	SME-8M-DS-24V-K-2.5-OE
				5.0	★ 543863	SME-8M-DS-24V-K-5.0-OE
			Cable, 2-wire	2.5	★ 543872	SME-8M-ZS-24V-K-2.5-OE
			Plug M8x1, 3-pin	0.3	★ 543861	SME-8M-DS-24V-K-0.3-M8D
N/C contact						
	Inserted in the slot lengthwise, flush with the cylinder profile	Contacting	Cable, 3-wire	7.5	160251	SME-8-O-K-LED-24

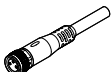
Ordering data – Mounting kits for proximity switch SME/SMT-8				Data sheets → Internet: smbr
Designation	For Ø	Part no.	Type	
Mounting kit SMBR-8				
	8	175091	SMBR-8-8	
	12	★ 175093	SMBR-8-12	
	16	★ 175094	SMBR-8-16	
	20	★ 175095	SMBR-8-20	
	25	★ 175096	SMBR-8-25	

Ordering data – Connecting cables					Data sheets → Internet: nebu
	Electrical connection, left	Electrical connection, right	Cable length [m]	Part no.	Type
	Straight socket, M8x1, 3-pin	Cable, open end, 3-wire	2.5	★ 541333	NEBU-M8G3-K-2.5-LE3
			5	★ 541334	NEBU-M8G3-K-5-LE3
	Straight socket, M12x1, 5-pin	Cable, open end, 3-wire	2.5	★ 541363	NEBU-M12G5-K-2.5-LE3
			5	★ 541364	NEBU-M12G5-K-5-LE3
	Angled socket, M8x1, 3-pin	Cable, open end, 3-wire	2.5	★ 541338	NEBU-M8W3-K-2.5-LE3
			5	★ 541341	NEBU-M8W3-K-5-LE3
	Angled socket, M12x1, 5-pin	Cable, open end, 3-wire	2.5	541367	NEBU-M12W5-K-2.5-LE3
			5	541370	NEBU-M12W5-K-5-LE3

Festo core product range



Generally ready for shipping ex works in 24 hours

Generally ready for shipping ex works in 5 days

Accessories

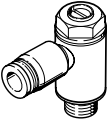
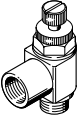
Ordering data – One-way flow control valves					Data sheets → Internet: grl			
	Connection Thread	For tubing O.D.	Material	Part no.	Type			
For exhaust air								
	M5	3	Metal design	★ 193137	GRLA-M5-QS-3-D			
		4		★ 193138	GRLA-M5-QS-4-D			
		6		★ 193139	GRLA-M5-QS-6-D			
	G1/8	3		★ 193142	GRLA-1/8-QS-3-D			
		4		★ 193143	GRLA-1/8-QS-4-D			
		6		★ 193144	GRLA-1/8-QS-6-D			
		8		★ 193145	GRLA-1/8-QS-8-D			
		For supply air						
		M5		3	Metal design	★ 193153	GRLZ-M5-QS-3-D	
				4		★ 193154	GRLZ-M5-QS-4-D	
6			★ 193155	GRLZ-M5-QS-6-D				
G1/8		3	★ 193156	GRLZ-1/8-QS-3-D				
		4	★ 193157	GRLZ-1/8-QS-4-D				
		6	★ 193158	GRLZ-1/8-QS-6-D				
		8	★ 193159	GRLZ-1/8-QS-8-D				

Festo core product range

- ★ Generally ready for shipping ex works in 24 hours
- ☆ Generally ready for shipping ex works in 5 days