

## Feed separators HPV

**FESTO**



## Key features

### Separation of workpieces in the feed process

#### Previously

- At least 2 drives, 2 valves and 4 proximity sensors
- Extensive programming

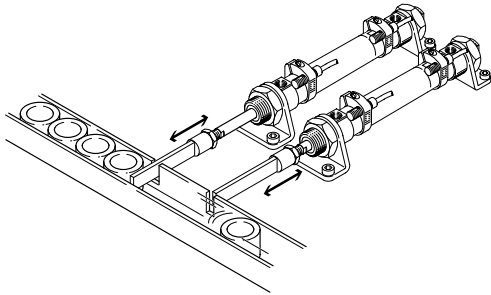

#### Now

- One unit (1 drive, 1 valve and 2 proximity sensors)
- Cheaper
- Reliable
- No programming required

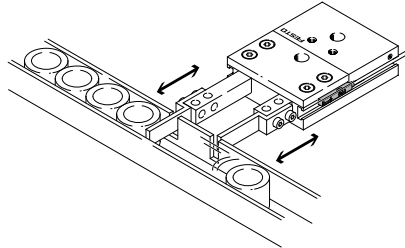

### High functionality

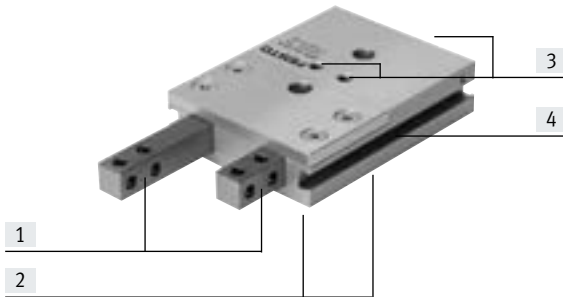

- [1] Corrosion-resistant thanks to stainless steel plungers
- [2] Optimum and precise adaptation options using centring sleeves
- [3] Supply ports optionally at top or rear
- [4] Proximity sensors suitable for integration in the housing can be used (type SME/SMT-8)



#### Note

An integrated mechanical interlock between the two plungers ensures that one plunger cannot retract until the other has advanced. Both plungers are briefly extended during switching and the part to be separated is enclosed.

### Operating principle

Plunger A is retracted. The locking mechanism locks plunger B.

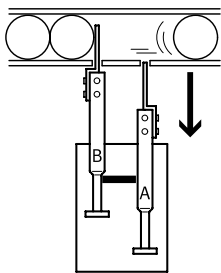

Plunger A advances.

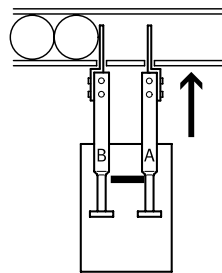

The locking mechanism prevents plunger B from retracting until plunger A is fully advanced.

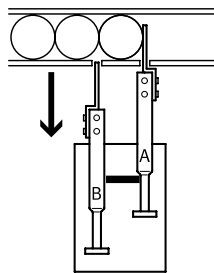

Plunger B advances.

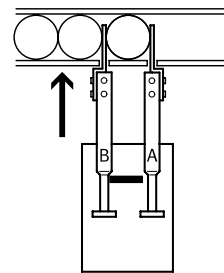

The locking mechanism prevents plunger A from retracting until plunger B is fully advanced.

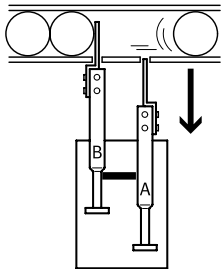

## Peripherals overview and type codes

### Peripherals overview

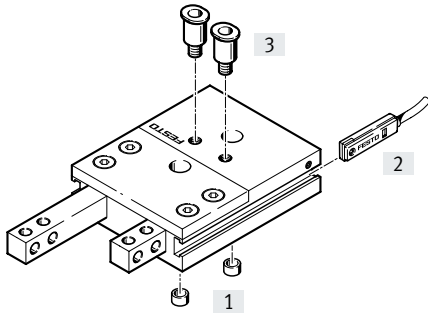



Accessories		Description	→ Page/Internet
[1]	Centring sleeve, connecting sleeve	For centring when mounting	9
[2]	Proximity sensor	For position sensing, integrated in sensor slot	9
[3]	QS push-in fitting	For connecting compressed air tubing with standard O.D.	qs

### Type codes

001	Series	003	Stroke
HPV	Separator, double-acting	10	10
		20	20
		30	30
		40	40
		60	60
002	Size	004	Position sensing
10	10	A	For proximity sensor
14	14		
22	22		

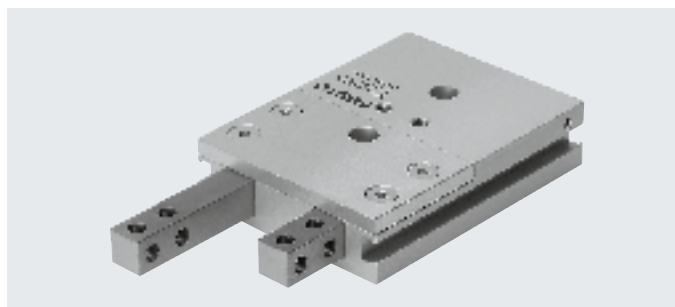
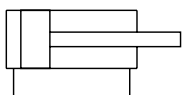
Data sheet



-  Size  
10 ... 22
-  Stroke length  
20 ... 60 mm

General technical data		10	14	22
Size		10	14	22
Pneumatic connection		M5/M3	M5/M5	
Mode of operation		Double-acting		
Operating medium		Compressed air to ISO 8573-1:2010 [7:4:4]		
Note on the operating/pilot medium		Lubricated operation possible (in which case lubricated operation will always be required)		
Design		Double piston		
		Piston rod		
		Locking mechanism		
		Non-rotating		
Protection against rotation/guide		Square		
Max. interchangeability	[mm]	0.3		
Cushioning		None		
Position sensing		Via proximity sensor		
Type of mounting		With through-hole		
		Via female thread		
Mounting position		Any		

Operating and environmental conditions		
Operating pressure	[bar]	3 ... 8
Ambient temperature	[°C]	+5 ... +60
Degree of protection		IP40
Corrosion resistance class CRC <sup>1)</sup>		2

1) Corrosion resistance class CRC 2 to Festo standard FN 940070  
Moderate corrosion stress. Indoor applications in which condensation can occur. External visible parts with primarily decorative surface requirements which are in direct contact with a normal industrial environment.

Forces [N]		10	14	22
Theoretical force at 6 bar Advancing		45	90	225
Theoretical force at 6 bar Retracting		35	75	180

Weight [g]		10	14	22		
Size		10	14	22		
Stroke		10	20	40	30	60
Product weight		135	290	460	950	1 500

Data sheet

Materials

Sectional view

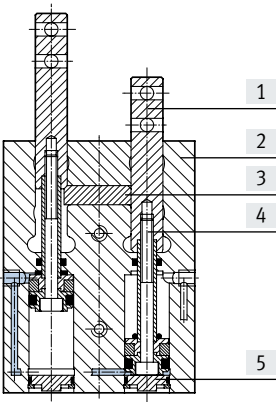

Feed separator		
[1]	Plunger	High-alloy steel
[2]	Housing	Wrought aluminium alloy (with CompCoat)
[3]	Locking mechanism	Case-hardened steel
[4]	Piston rod	High-alloy steel
[5]	End cap	High-alloy steel
-	Seals	Nitrile rubber
Note on materials		Copper/PTFE-free
		RoHS-compliant

Note

The plunger slideways in the housing are determined by choosing the appropriate fit, and cannot be adjusted. The necessary basic lubrication is applied during assembly. We recommend that the feed separator be re-lubricated after 2 million cycles.

Cycle times [ms] without add-on plunger separators at 6 bar (unrestricted)

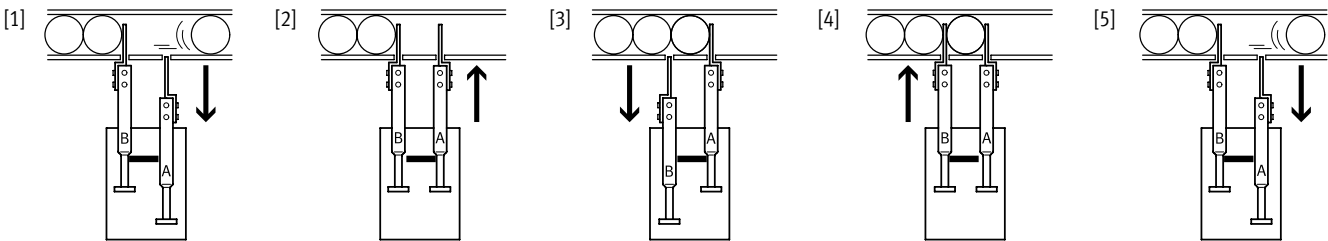

Size	10	14	22		
Stroke	10	20	30	40	60
Half cycle time (number [1] ... [3])	26.5	111.5	234.2	152.4	398.1
Cycle time (number [1] ... [5])	52.5	223	468.4	304.8	796.1

Max. permissible weight [g] of add-on plunger separators for unrestricted operation

Size	10	14	22
Add-on plunger separators <sup>1)</sup>	56	150	395

1) If the max. permissible weights of the add-on plunger separators are exceeded, the retracting and advancing times must be adapted in accordance with the table below using one-way flow control valves. Failure to do so may result in components of the feed separator being damaged.

Retracting and advancing times [s] with add-on plunger separators as a function of the mass [g] of the plunger separators

Size	10	14	22			
Stroke	10	20	30	40	60	
Weight force	100 g	0.03	-	-	-	-
	200 g	0.04	0.03	0.05	-	-
	300 g	0.05	0.04	0.08	-	-
	400 g	0.06	0.05	0.11	0.24	0.48
	500 g	-	0.07	0.13	0.3	0.6
	600 g	-	-	-	0.36	0.72
	700 g	-	-	-	0.42	0.84
	800 g	-	-	-	0.48	0.96

## Data sheet

### Permissible characteristic static load values at the plungers

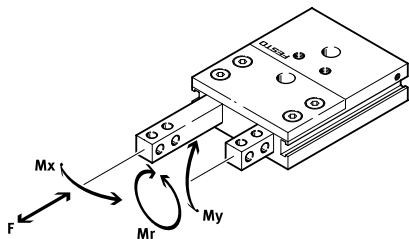

Size		10	14	22
Force F	[N]	75	100	180
Torque $M_x$	[Nm]	3	5	9
Torque $M_y$	[Nm]	3	5	9
Torque $M_r$	[Nm]	3	5	9

### Plunger backlash

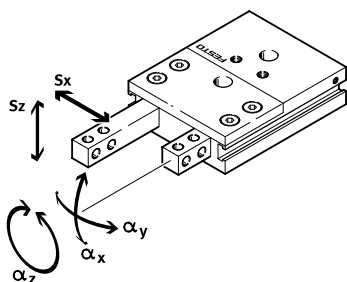

Size		10			14		22	
Stroke		10	20	40	30	60		
$S_x$	[mm]	0.05	0.05	0.05	0.05	0.05		
$S_z$	[mm]	0.03	0.03	0.03	0.03	0.03		
$\alpha_x$	[°]	0.12	0.12	0.07	0.06	0.04		
$\alpha_y$	[°]	0.2	0.2	0.12	0.11	0.07		
$\alpha_z$	[°]	0.262	0.175	0.175	0.12	0.12		

### Minimum clearances

To prevent malfunctioning of the proximity sensors, the feed separators must comply with the minimum clearances specified in the table.

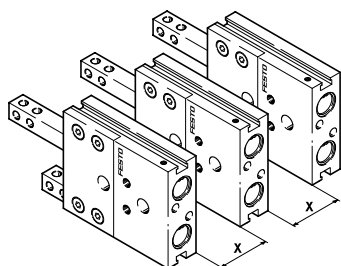

Size		10	14	22
For SME-8-...	[mm]	60	59	73
For SMT-8-...-B	[mm]	60	54	69

## Data sheet

### Projection of proximity sensors

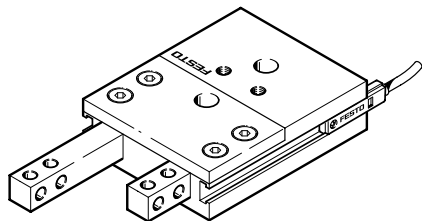

Size		10	14	22
For SME-8-...	[mm]	max. 14 <sup>1)</sup>		
For SMT-8-...	[mm]	max. 22 <sup>1)</sup>		

1) Depending on mounting position

### Mounting options

Only the underside (opposite the supply ports) may be used as a mounting surface.

#### From above via through-hole

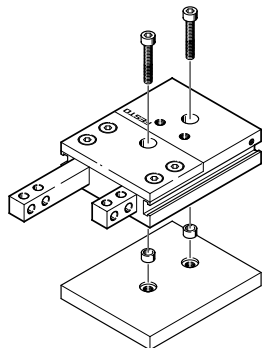

Size		10	14	22
Screw		M3	M4	M6
Permitted tightening torque	[Nm]	1.2	2.9	9.9

#### From below via female thread

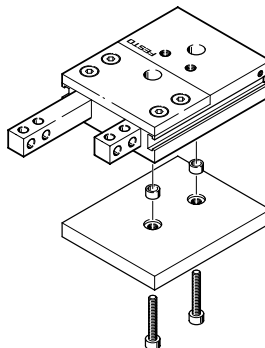

Size		10	14	22
Screw		M4	M5	M8
Permitted tightening torque	[Nm]	2.9	5.9	24

### Surface finish and positional accuracy of bearing surface

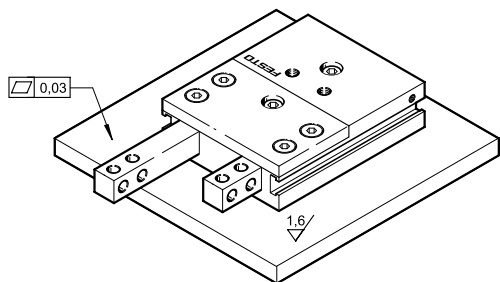

Data sheet

Dimensions

Download CAD data → [www.festo.com](http://www.festo.com)

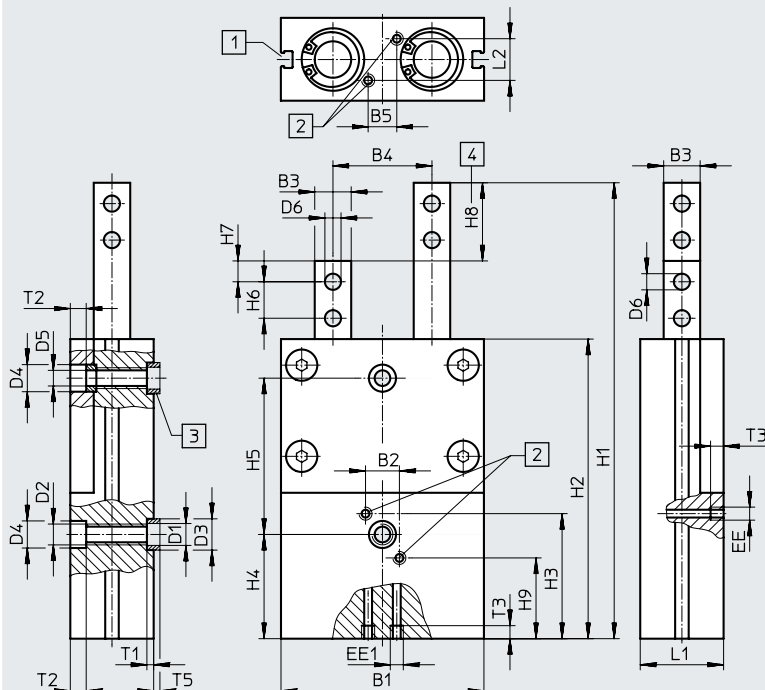

- [1] Sensor slot for proximity sensor
- [2] Choice of supply port
- [3] Centring sleeves (2 included in scope of delivery)
- [4] Stroke

Type	B1	B2	B3 ±0.02	B4 ±0.05	B5	D1 ∅	D2	D3 H8/h7 ∅	D4 H13 ∅	D5 H13 ∅	D6 H13 ∅	EE	EE1	H1
HPV-10-10-A	47	6	7	20	7	5.3	M4	7	6	–	3.2	M5	M3	78
HPV-14-20-A	60	12	10	30	10	5.3	M5	7	7.4	–	4.2	M5	M5	119
HPV-14-40-A	60	12	10	30	10	5.3	M5	7	7.4	–	4.2	M5	M5	189
HPV-22-30-A	78	13	14	38	11	8.4	M8	12	10.4	6.2	6.2	M5	M5	175
HPV-22-60-A	78	13	14	38	11	8.4	M8	12	10.4	6.2	6.2	M5	M5	280

Type	H2	H3	H4 ±0.1	H5 <sup>1)</sup>	H6 ±0.2	H7 ±0.1	H8 ±0.5	H9	L1	L2	T1 +0.1	T2	T3 min.	T5 –0.3
HPV-10-10-A	53	24.5	16	30	7	4	10	7.5	18	9	1.6	3.1	4	1.4
HPV-14-20-A	79	36	20	30	10	5	20	36	19	7	1.6	4.6	5	1.4
HPV-14-40-A	129	56	20	60	10	5	40	56	19	7	1.6	4.6	5	1.4
HPV-22-30-A	115	48	40	60	14	8	30	48	32	16	2.6	6.1	5	2.4
HPV-22-60-A	190	78	40	120	14	8	60	78	32	16	2.6	6.1	5	2.4

1) Tolerance for centring hole ±0.02  
Tolerance for thread and through-hole ±0.1

Ordering data

Size	Stroke [mm]	Part no.	Type
10	10	550908	HPV-10-10-A
14	20	529351	HPV-14-20-A
	40	529352	HPV-14-40-A
22	30	529353	HPV-22-30-A
	60	529354	HPV-22-60-A





## Accessories

Ordering data		Part no.	Type	Data sheets → Internet: zbh
For size				PU <sup>1)</sup>
<b>Centring sleeve ZBH</b>				
	10, 14	8146544	ZBH-7-B	10
	22	189653	ZBH-12	10

1) Packaging unit

Ordering data – Proximity sensor for T-slot, magneto-resistive					Data sheets → Internet: smt	
Type of mounting	Switching output	Electrical connection	Cable length [m]	Part no.	Type	
<b>N/O contact</b>						
	Inserted in the slot from above, flush with the cylinder profile, short design	PNP	Cable, 3-wire	2.5	574335	SMT-8M-A-PS-24V-E-2.5-OE
			Plug M8x1, 3-pin	0.3	574334	SMT-8M-A-PS-24V-E-0.3-M8D

Ordering data – Proximity sensor for T-slot, magnetic reed					Data sheets → Internet: sme	
Type of mounting	Switching output	Electrical connection	Cable length [m]	Part no.	Type	
<b>N/O contact</b>						
	Inserted in the slot lengthwise, flush with the cylinder profile	Contacting	Cable, 3-wire	2.5	150855	SME-8-K-LED-24
				Plug M8x1, 3-pin	0.3	150857

Ordering data – Connecting cables				Data sheets → Internet: nebu	
Electrical connection, left	Electrical connection, right	Cable length [m]	Part no.	Type	
	Straight socket, M8x1, 3-pin	Cable, open end, 3-wire	2.5	541333	NEBU-M8G3-K-2.5-LE3
			5	541334	NEBU-M8G3-K-5-LE3
	Straight socket, M12x1, 5-pin	Cable, open end, 3-wire	2.5	541363	NEBU-M12G5-K-2.5-LE3
			5	541364	NEBU-M12G5-K-5-LE3
	Angled socket, M8x1, 3-pin	Cable, open end, 3-wire	2.5	541338	NEBU-M8W3-K-2.5-LE3
			5	541341	NEBU-M8W3-K-5-LE3
	Angled socket, M12x1, 5-pin	Cable, open end, 3-wire	2.5	541367	NEBU-M12W5-K-2.5-LE3
			5	541370	NEBU-M12W5-K-5-LE3

Ordering data – Slot cover				
Mounting	Length [m]	Part no.	Type	
	Inserted from above	2 x 0.5	151680	ABP-5-S

Ordering data – One-way flow control valves				Data sheets → Internet: grla-m5-qs	
Connection Thread	For tubing O.D.	Material	Part no.	Type	
	M5	Metal design	3	193137	GRLA-M5-QS-3-D
			4	193138	GRLA-M5-QS-4-D
			6	193139	GRLA-M5-QS-6-D