

Guided drives DFM-N-B, NPT

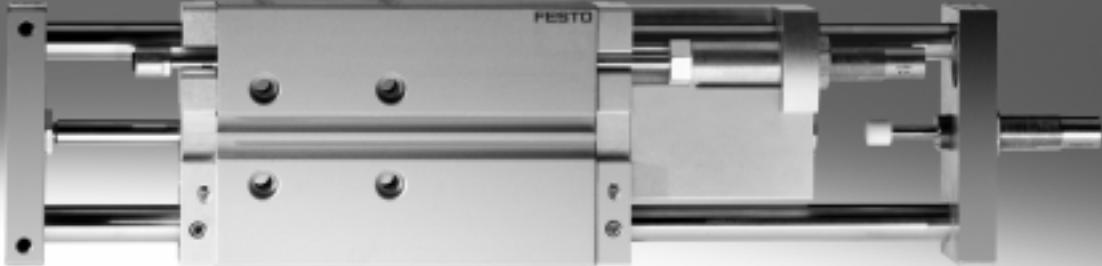

Guided drives DFM-N-B, NPT

Key features

FESTO

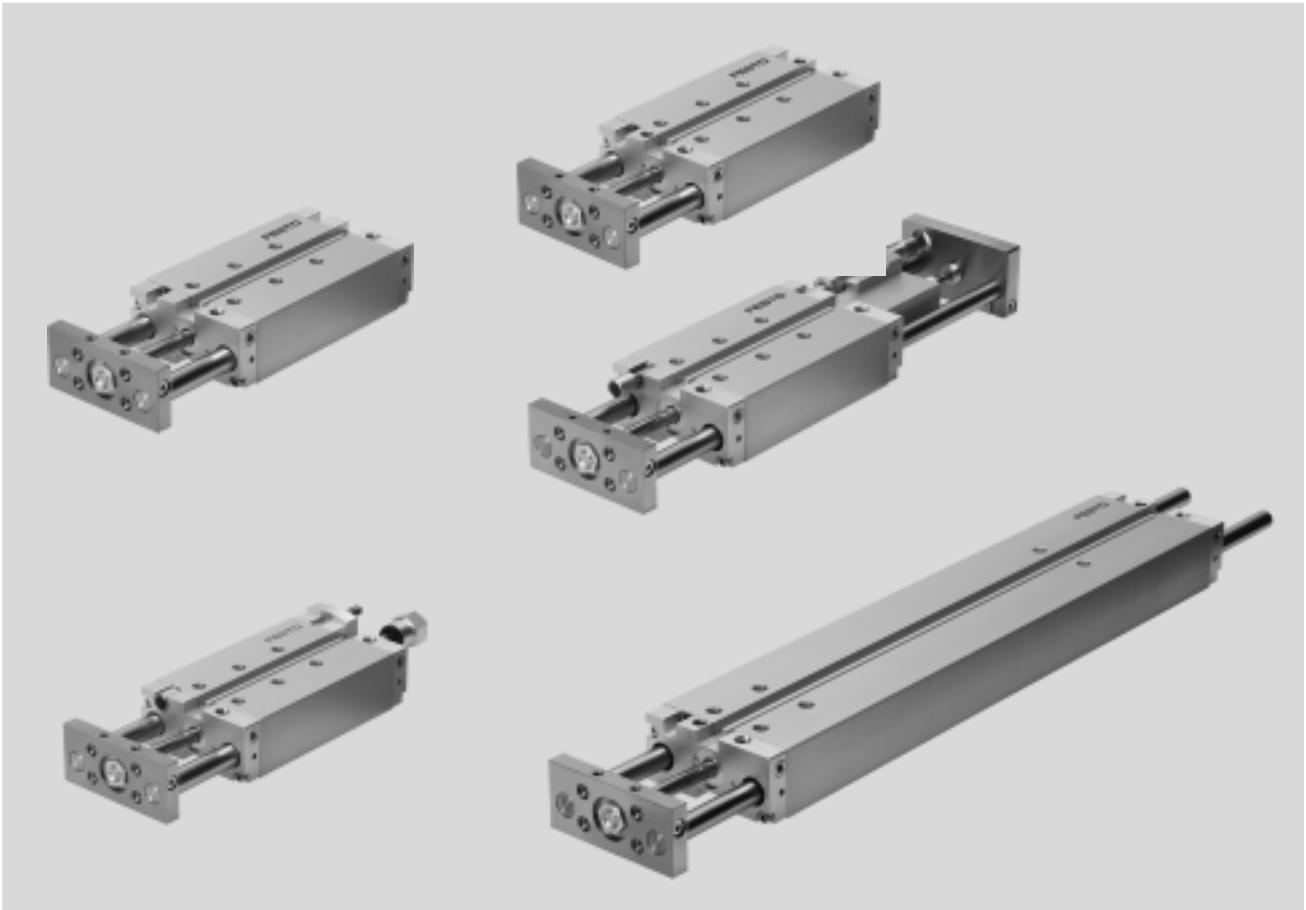

Drive and guide unit in a single housing

- Minimal space requirement
- Minimal assembly time
- Choice of supply ports
- Wide range of mounting options

Sturdy and precise

- Good protection against torsion
- Rigid construction
- Maintenance-free

High resistance to torques and lateral forces

- With plain-bearing guide: It offers high rigidity thanks to its guide rods with large diameter and four plain-bearing bushes
- With recirculating ball bearing guide: For applications involving torque loads

Wide choice of variants

- With heat-resistant seals up to 120 °C
- With adjustable end position
- With shock absorbers
- With pneumatic end-position cushioning
- Long-stroke versions

Guided drives DFM-N-B, NPT

Key features

Use in conveyor systems

Lifting

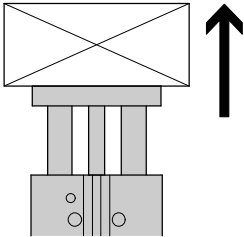

Pushing

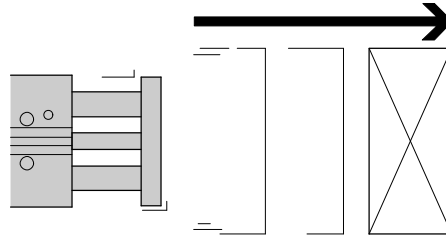

Stopping

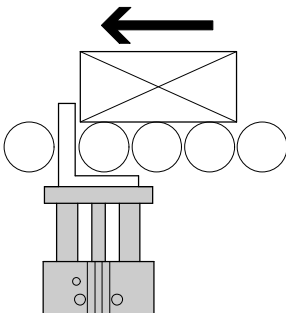

Stopping via stop bracket

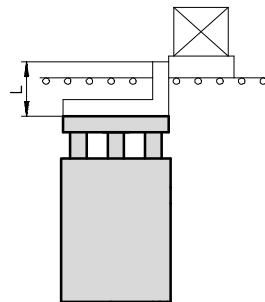

It is recommended to fit a buffer on the workpiece carrier.

Mounting options

Flat from above

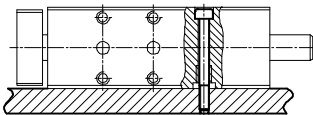

Flat from below

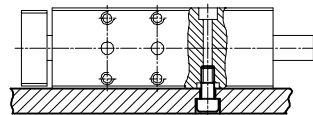

Side from below

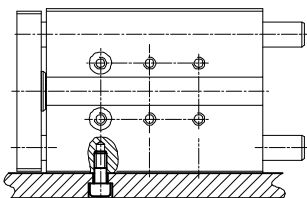

On end

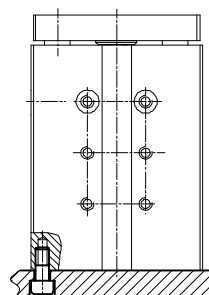

Guided drives DFM-N-B, NPT

Product range overview

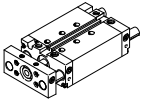
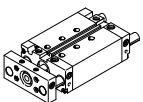
Function	Version	Type	Piston \varnothing	Stroke	Variable stroke
			[mm]	[mm]	[mm]
Double-acting	DFM-N-B with recirculating ball bearing guide				
		DFM-N-B Single-ended piston rod	12, 16	10, 20, 25, 30, 40, 50, 80, 100, 125, 160, 200	10 ... 200
			20, 25, 32	20, 25, 30, 40, 50, 80, 100, 125, 160, 200, 250, 320, 400	20 ... 400
			40, 50, 63	25, 50, 80, 100, 125, 160, 200, 250, 320, 400	25 ... 400
	DFM-N-B with plain-bearing guide				
		DFM-N-B Single-ended piston rod	12, 16	10, 20, 25, 30, 40, 50, 80, 100, 125, 160, 200	10 ... 200
			20, 25, 32	20, 25, 30, 40, 50, 80, 100, 125, 160, 200, 250, 320, 400	20 ... 400
			40, 50, 63	25, 50, 80, 100, 125, 160, 200, 250, 320, 400	25 ... 400

Guided drives DFM-N-B, NPT

Product range overview

Type	Position sensing	Cushioning			Heat-resistant seals	Precision end-position adjustment		→ Page/Internet
		Not adjustable	Adjustable for heavy loads	Self-adjusting end position adjustable for heavy loads		Advanced end position	Retracted end position	
	A	P	PPV	YSRW	S6	AJ	EJ	
DFM-N-B with recirculating ball bearing guide								
DFM-N-B Single-ended piston rod	■	■	■ Ø 16 and above	■ Ø 20 and above	–	■	■ Ø 20 and above	6
DFM-N-B with plain-bearing guide								
DFM-N-B Single-ended piston rod	■	■	■ Ø 16 and above	–	■	■	■ Ø 20 and above	6

Guided drives DFM-N-B, NPT

Peripherals overview

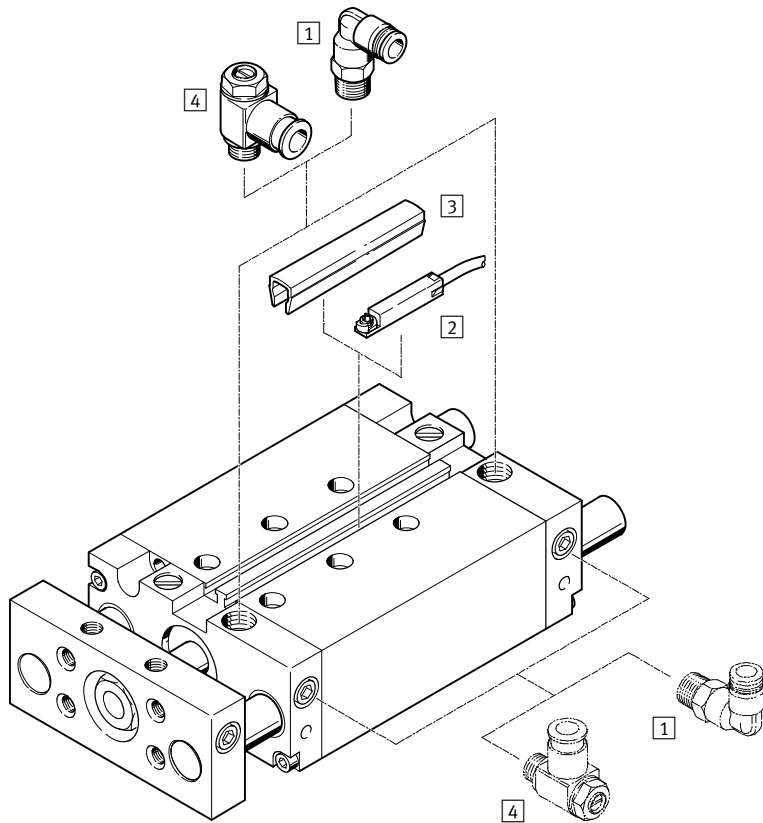

DFM-N-B-12-P

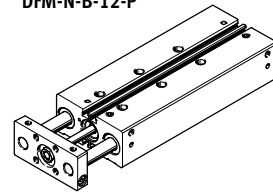

DFM-N-B-12-P-AJ

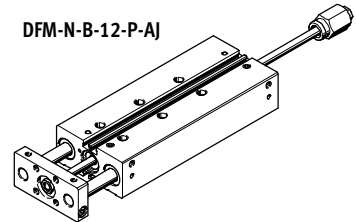

Variants

AJ

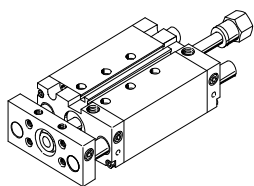

EJ

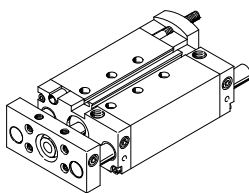

AJ + EJ

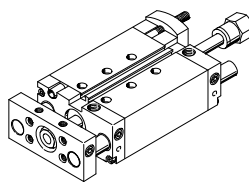

YSRW

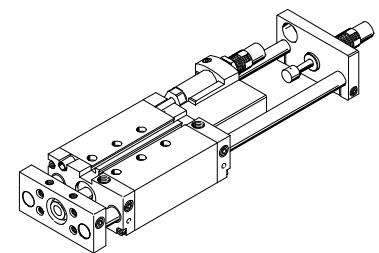

Accessories

Accessories	Description	→ Page/Internet
1 Push-in fitting QS	For connecting compressed air tubing with standard O.D.	qs
2 Proximity sensor SME-/SMT-8	Can be integrated in the profile barrel	41
3 Slot cover ABP-5-S	For protecting the sensor cable and keeping dirt out of the sensor slots	40
4 One-way flow control valve GRLA	For speed regulation	42
- Centring sleeves ZBH	4 or 6 pieces included in the scope of delivery	40

-  - Note
Proximity sensors SM...0-8E cannot be used with the DFM-N-B.

Guided drives DFM-N-B, NPT

Type codes

DFM – N – 50 – 80 – B – P – A – GF – S6 – AJ – ZUB – 10S – G

Type

DFM	Guided drive
-----	--------------

System of units

N	Imperial
---	----------

Piston Ø [mm]

Stroke [mm]

Generation

B	Series
---	--------

Cushioning

P	Flexible cushioning rings/pads at both ends
PPV	Pneumatic cushioning, adjustable at both ends
YSRW	Self-adjusting at both ends

Position sensing

A	Via proximity sensor
---	----------------------

Guide

GF	Plain-bearing guide
KF	Recirculating ball bearing guide

Variant

S6	Heat-resistant seals up to max. 120 °C
----	--

Precision adjustment

AJ	Advanced end position
EJ	Retracted end position

Accessories

ZUB	Supplied separately
-----	---------------------

Slot cover

...S	Sensor slot
------	-------------

Proximity sensor

...G	With cable, 2.5 m
...I	Contactless with cable, 2.5 m

Guided drives DFM-N-B, NPT



Technical data

FESTO

Function

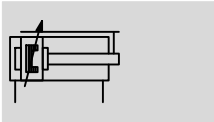
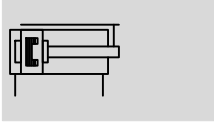
 www.festo.com



-  Diameter
12 ... 63 mm
-  Stroke length
10 ... 400 mm

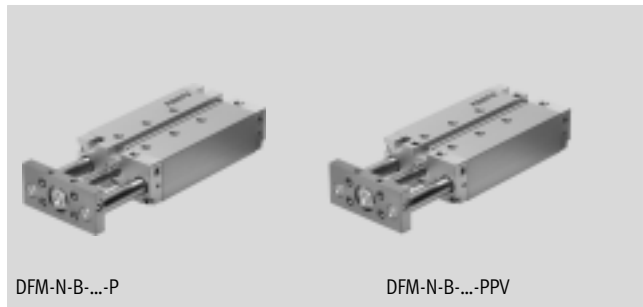

DFM-N-B-...-P

DFM-N-B-...-PPV

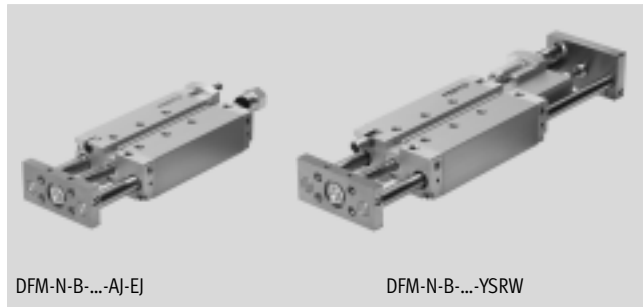

DFM-N-B-...-AJ-EJ

DFM-N-B-...-YSRW

General technical data									
Piston \varnothing		12	16	20	25	32	40	50	63
Pneumatic connection		M5 suitable for 10-32 UNF				1/8NPT		1/4 NPT	
Design		Piston							
		Piston rod							
		Guide rods with yoke							
Cushioning									
DFM-...-P		Flexible cushioning rings/pads at both ends							
DFM-...-PPV		-	Pneumatic cushioning, adjustable at both ends						
DFM-...-YSRW		-	-	Self-adjusting at both ends					
Cushioning length									
DFM-...-PPV	[mm]	-	12	15	15	16	17	19	19
Position sensing		Via proximity sensor							
Type of mounting		Via through-holes							
		Via female thread							
Mounting position		Any							
Protection against torsion/guide		Guide rod with yoke/plain-bearing or recirculating ball bearing guide							
Variant AJ, EJ and YSRW									
Setting range	[mm]	0 ... 10							
Variant EJ and YSRW									
Setting range	[mm]	-	-	0 ... 10					
Variant YSRW with shock absorber									
Repetition accuracy	[mm]	-	-	Max. 0.05					

- || - Note: This product conforms to ISO 1179-1 and to ISO 228-1

Guided drives DFM-N-B, NPT

Technical data

Ambient conditions								
Piston Ø	12	16	20	25	32	40	50	63
Operating pressure [bar]	2 ... 10			1.5 ... 10			1 ... 10	
Operating medium	Compressed air in accordance with ISO 8573-1:2010 [7:4:4]							
Note on operating/pilot medium	Operation with lubricated medium possible (in which case lubricated operation will always be required)							
Ambient temperature ¹⁾								
DFM-...-GF [°C]	-20 ... +80							
DFM-...-KF [°C]	-5 ... +60							
DFM-...-YSRW [°C]	0 ... +60							
DFM-...-S6 [°C]	0 ... +120							
Corrosion resistance class CRC ²⁾								
DFM-...-GF	2							
DFM-...-S6	2							
ATEX	Specified types → www.festo.com							

1) Note operating range of proximity sensors

2) Corrosion resistance class 2 to Festo standard 940 070

Components subject to moderate corrosion stress. Externally visible parts with primarily decorative surface requirements which are in direct contact with a normal industrial environment or media such as coolants or lubricating agents

Speed [m/s]								
Piston Ø	12	16	20	25	32	40	50	63
Cushioning P, precision stroke adjustment AJ and EJ								
Maximum speed advancing, retracting	0.8	0.8	0.8	0.8	0.8	0.8	0.6	0.6
Cushioning P, plain-bearing guide GF in combination with S6								
Maximum speed advancing, retracting	0.5	0.5	0.5	0.5	0.5	0.5	0.4	0.4
Cushioning PPV, YSRW, PPV S6								
Maximum speed advancing, retracting	-	1.5	1.5	1.5	1.5	1.5	1	1

Forces [N]								
Piston Ø	12	16	20	25	32	40	50	63
Cushioning P, PPV, YSRW, precision stroke adjustment EJ								
Theoretical force at 6 bar, advancing	68	121	188	295	482	754	1178	1870
Theoretical force at 6 bar, retracting	51	90	141	247	415	686	1057	1750
Precision stroke adjustment AJ and AJ+EJ								
Theoretical force at 6 bar, advancing	51	90	141	247	415	686	1057	1750
Theoretical force at 6 bar, retracting	51	90	141	247	415	686	1057	1750

Guided drives DFM-N-B, NPT

Technical data

Impact energy [J]								
Piston Ø	12	16	20	25	32	40	50	63
Cushioning P								
Max. impact energy in the end positions	0.09	0.15	0.2	0.35	0.40	0.7	1.0	1.3
Max. impact energy in the end positions S6	0.035	0.075	0.1	0.15	0.2	0.35	0.5	0.65
Cushioning YSRW								
Max. energy absorption per stroke	-	-	4	8	12	35	35	70
Max. energy absorption per hour	-	-	21000	30000	41000	68000	68000	100000

Permissible impact velocity:
$$v_{perm.} = \sqrt{\frac{2 \times E_{perm.}}{m_{dead} + m_{load}}}$$

Maximum permissible load:
$$m_{load} = \frac{2 \times E_{perm.}}{v^2} - m_{dead}$$

- $v_{perm.}$ Permissible impact velocity
- $E_{perm.}$ Max. impact energy
- $m_{intrinsic}$ Moving load (drive)
- m_{Load} Moving effective load

 Note
This data represents the maximum values that can be achieved. The maximum permissible impact energy must be observed.

Guided drives DFM-N-B, NPT

Technical data

DFM-N-B with plain-bearing guide GF, cushioning P, PPV								
Stroke [mm]	Piston Ø [mm]							
	12	16	20	25	32	40	50	63
Product weight [g]								
10	385	621	–	–	–	–	–	–
20	432	680	1026	1474	2163	–	–	–
25	452	706	1068	1530	2238	2606	4290	5568
30	476	736	1109	1586	2337	–	–	–
40	523	795	1215	1726	2489	–	–	–
50	570	854	1298	1838	2640	3047	5019	6457
80	712	1033	1572	2218	3210	3663	5909	7503
100	803	1148	1733	2435	3502	3981	6376	8116
125	962	1352	2000	2800	4018	4534	7151	9050
160	1128	1560	2293	3193	4549	5118	8017	10137
200	1318	1797	2628	3642	5158	5786	9007	11379
250	–	–	3237	4430	6259	6962	10813	13509
320	–	–	3823	5215	7322	8129	12545	15682
400	–	–	4493	6113	8537	9462	14525	18165
Moving load [g]								
10	201	283	–	–	–	–	–	–
20	216	302	506	715	1147	–	–	–
25	223	312	520	734	1176	1305	2217	2640
30	230	322	534	753	1230	–	–	–
40	245	342	586	823	1289	–	–	–
50	260	362	615	861	1347	1476	2567	2990
80	304	423	724	1022	1644	1776	3002	3426
100	333	463	781	1098	1764	1893	3189	3613
125	420	579	917	1289	2059	2188	3586	4009
160	472	649	1016	1422	2264	2393	3913	4336
200	530	730	1129	1573	2499	2627	4286	4710
250	–	–	1489	2017	3164	3293	5351	5774
320	–	–	1688	2283	3574	3703	6005	6428
400	–	–	1914	2587	4042	4171	6752	7176

Guided drives DFM-N-B, NPT



Technical data

DFM-N-B with plain-bearing guide GF, cushioning P, PPV, variant S6								
Stroke [mm]	Piston Ø [mm]							
	12	16	20	25	32	40	50	63
Product weight [g]								
0	283	488	745	1080	1594	1847	3124	3992
10	328	548	–	–	–	–	–	–
20	376	607	907	1298	1889	–	–	–
25	395	633	949	1354	1964	2257	3735	4762
30	419	663	990	1410	2063	–	–	–
40	466	722	1096	1550	2215	–	–	–
50	514	781	1179	1662	2366	2698	4464	5651
80	656	959	1452	2042	2936	3314	5354	6696
100	747	1074	1614	2259	3228	3632	5821	7310
125	905	1279	1880	2624	3745	4186	6596	8244
160	1072	1486	2173	3017	4276	4770	7462	9331
200	1261	1724	2508	3466	4884	5437	8452	10573
250	–	–	3118	4254	5985	6613	10258	12703
320	–	–	3704	5039	7048	7780	11990	14876
400	–	–	4374	5937	8264	9114	19970	17359
Moving load [g]								
0	130	188	329	463	755	810	1428	1601
10	145	208	–	–	–	–	–	–
20	159	229	386	539	873	–	–	–
25	167	239	400	558	902	956	1662	1834
30	174	249	414	577	956	–	–	–
40	188	269	467	647	1015	–	–	–
50	203	289	495	685	1073	1127	2012	2184
80	247	349	604	847	1373	1427	2447	2620
100	276	389	661	922	1490	1544	2634	2806
125	364	506	797	1113	1785	1840	3031	3203
160	415	576	896	1246	1990	2045	3358	3530
200	474	657	1010	1397	2225	2279	3731	3904
250	–	–	1370	1842	2890	2944	4796	4968
320	–	–	1568	2107	3300	3354	5450	5622
400	–	–	1794	2411	3768	3823	6197	6370

Guided drives DFM-N-B, NPT

Technical data

DFM-N-B with recirculating ball bearing guide KF, cushioning P, PPV								
Stroke [mm]	Piston Ø [mm]							
	12	16	20	25	32	40	50	63
Product weight [g]								
10	345	543	–	–	–	–	–	–
20	388	596	935	1395	1932	–	–	–
25	405	619	974	1447	1998	2366	3907	5185
30	427	647	1012	1499	2079	–	–	–
40	470	700	1105	1624	2213	–	–	–
50	513	754	1181	1729	2346	2753	4523	5961
80	641	916	1428	2074	2817	3270	5272	6865
100	723	1020	1577	2276	3073	3552	5682	7423
125	852	1190	1809	2599	3490	4006	6327	8226
160	1002	1378	2079	2966	3958	4526	7094	9214
200	1174	1593	2388	3384	4494	5121	7971	10343
250	–	–	2905	4073	5369	6072	9419	12115
320	–	–	3445	4805	6305	7112	10953	14091
400	–	–	4063	5642	7376	8301	12707	16347
Moving load [g]								
10	168	239	–	–	–	–	–	–
20	178	254	437	631	933	–	–	–
25	183	261	447	646	954	1082	1830	2254
30	188	268	458	661	990	–	–	–
40	198	283	498	716	1030	–	–	–
50	208	297	520	746	1071	1199	2067	2491
80	238	341	602	873	1271	1400	2361	2785
100	259	370	646	934	1352	1481	2492	2915
125	316	452	748	1083	1548	1677	2758	3182
160	352	503	824	1189	1690	1819	2986	3410
200	392	561	911	1310	1852	1981	3247	3671
250	–	–	1180	1656	2291	2420	3953	4377
320	–	–	1332	1868	2575	2703	4410	4833
400	–	–	1505	2111	2899	3027	4931	5355

Guided drives DFM-N-B, NPT

Technical data

FESTO

Additional weights with precision stroke adjustment AJ – GF, KF

When using the precision stroke adjustment AJ, the following weight must be taken into account in addition to the load specified from page 10.

Product weight [g] – Precision stroke adjustment AJ (piston rod + stop)								
Stroke [mm]	Piston Ø [mm]							
	12	16	20	25	32	40	50	63
10	55.4	58.8	–	–	–	–	–	–
20	57.6	61	75.6	115.4	185.7	–	–	–
25	58.7	62.1	77.6	118.5	190.2	188.7	350.7	350.5
30	59.9	63.3	79.6	121.6	194.7	–	–	–
40	62.1	65.5	83.6	127.8	203.6	–	–	–
50	64.3	67.7	87.5	134	212.5	211	390.4	390.2
80	71	74.4	99.5	152.6	239.3	237.8	438	437.8
100	75.5	78.9	107.5	165	257.2	255.7	469.8	469.6
125	81.1	84.5	117.3	180.5	279.5	278	509.5	509.3
160	88.9	92.3	131.2	202.5	310.8	309.3	565.1	564.9
200	97.8	101.2	147.1	227	346.5	345	628.6	628.4
250	–	–	167	258.1	391.2	389.7	708.1	707.9
320	–	–	194.8	301.5	453.8	452.3	819.2	819
400	–	–	226.5	351.1	525.2	523.7	946.3	946.1

Moving load [g] – Precision stroke adjustment AJ (piston rod + stop)								
Stroke [mm]	Piston Ø [mm]							
	12	16	20	25	32	40	50	63
10	51.5	52.3	–	–	–	–	–	–
20	53.7	54.5	76	116.6	185.9	–	–	–
25	54.8	55.6	78	119.7	190.4	190	351.7	351.7
30	56	56.8	80	122.8	194.9	–	–	–
40	58.2	59	84	129	203.8	–	–	–
50	60.4	61.2	87.9	135.2	212.7	212.7	391.4	391.4
80	67.1	67.9	99.9	153.8	239.5	239.5	439	439
100	71.6	72.4	107.8	166.2	257.4	257.4	470.8	470.8
125	77.2	78	117.7	181.7	279.7	279.7	510.5	510.5
160	85	85.8	131.6	203.4	311	311	566.1	566.1
200	93.9	94.7	147.5	228.2	346.7	346.7	629.6	629.6
250	–	–	167.4	259.3	391.4	391.4	709.1	709.1
320	–	–	195.2	302.7	454	454	820.2	820.2
400	–	–	226.9	352.3	525.4	525.4	947.3	947.3

Guided drives DFM-N-B, NPT

Technical data

Additional weights with precision stroke adjustment EJ – GF, KF

When using the precision stroke adjustment EJ, the following weight must be taken into account in addition to the load specified from page 10.

Product weight [g] – Precision stroke adjustment EJ (piston rod + stop)						
Stroke [mm]	Piston Ø [mm]					
	20	25	32	40	50	63
20	55.7	117.1	134.1	–	–	–
25	56.4	119.1	136.1	153.9	302.8	354
30	57.2	121	138	–	–	–
40	58.8	125	142	–	–	–
50	60.3	129	146	163.8	318.3	369.5
80	65	140.9	157.9	175.7	336.9	388.1
100	68.1	148.8	165.8	183.6	349.4	400.6
125	71.9	158.8	175.8	193.6	364.9	416.1
160	77.4	172.7	189.7	207.5	386.6	437.8
200	83.6	188.5	205.5	223.3	411.4	462.6
250	91.3	208.4	225.4	243.2	442.4	493.6
320	102.2	236.2	253.2	271	485.9	537.1
400	114.6	268	285	302.8	535.5	586.7

DFM-N-B with recirculating ball bearing guide KF, cushioning YSRW						
Stroke [mm]	Piston Ø [mm]					
	20	25	32	40	50	63
Product weight [g]						
20	1684	2641	3717	–	–	–
25	1733	2707	3801	4995	7594	10816
30	1780	2773	3884	–	–	–
40	1874	2903	4053	–	–	–
50	1970	3035	4222	5455	8275	11657
80	2257	3429	4720	5999	9092	12629
100	2444	3687	5047	6352	9614	13298
125	2677	4008	5458	6801	10294	14137
160	3015	4473	6050	7446	11255	15319
200	3401	5004	6728	8183	12354	16670
250	3855	5641	7545	9074	13700	18340
320	4530	6569	8730	10363	15623	20704
400	5302	7631	10085	11837	17821	23405
Moving load [g]						
20	874	1323	1933	–	–	–
25	894	1350	1696	2386	3735	4996
30	914	1378	2005	–	–	–
40	953	1432	2077	–	–	–
50	993	1487	2149	2566	4021	5282
80	1111	1650	2365	2782	4365	5625
100	1190	1759	2509	2926	4594	5855
125	1289	1896	2690	3106	4880	6141
160	1427	2087	2942	3359	5281	6542
200	1585	2305	3230	3647	5739	7000
250	1782	2578	3590	4007	6312	7572
320	2059	2959	4095	4512	7114	8374
400	2375	3396	4671	5088	8030	9290

Guided drives DFM-N-B, NPT

Technical data

Materials

Sectional view

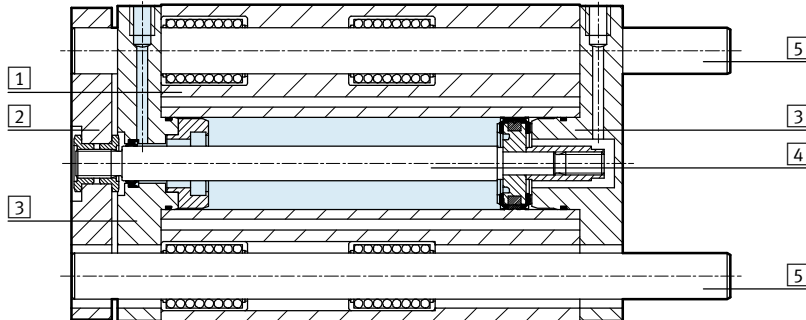

Guided drive	Plain-bearing guide GF	Recirculating ball bearing guide KF	S6
1 Housing	Anodised wrought aluminium alloy	Anodised wrought aluminium alloy	Anodised wrought aluminium alloy
2 Yoke plate	Tempered steel	Tempered steel	Wrought aluminium alloy
3 Bearing and end caps	Anodised wrought aluminium alloy	Anodised wrought aluminium alloy	Anodised wrought aluminium alloy
4 Piston rod	High-alloy stainless steel	High-alloy stainless steel	High-alloy stainless steel
5 Guide rods	High-alloy steel	Tempered steel	High-alloy steel
- Static seals	Nitrile rubber	Nitrile rubber	Fluoro elastomer
- Dynamic seals	Polyurethane	Polyurethane	Fluoro elastomer
Note on material	RoHS-compliant		

Guided drives DFM-N-B, NPT

Technical data

FESTO

Maximum effective load F [N]

Plain-bearing guide GF and recirculating ball bearing guide KF

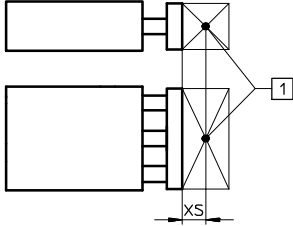

1 Centre of gravity of effective load

Piston Ø	12	16	20	25	32	40	50	63
XS [mm]	25	50	50	50	50	50	50	50

Stroke [mm]		Piston Ø							
		12	16	20	25	32	40	50	63
10	GF	53	95	–	–	–	–	–	–
	KF	47	75	–	–	–	–	–	–
20	GF	47	86	99	121	188	–	–	–
	KF	42	69	80	88	120	–	–	–
25	GF	45	83	96	116	180	180	257	257
	KF	40	66	77	86	118	118	182	182
30	GF	43	79	92	112	173	–	–	–
	KF	38	64	75	84	116	–	–	–
40	GF	39	73	110	123	161	–	–	–
	KF	35	58	91	100	112	–	–	–
50	GF	36	67	103	115	150	150	216	216
	KF	32	56	88	97	109	109	168	168
80	GF	28	55	86	96	166	166	234	234
	KF	26	51	80	89	134	134	201	201
100	GF	25	49	77	86	150	150	212	212
	KF	23	48	75	85	128	128	193	193
125	GF	23	37	71	86	168	168	229	229
	KF	20	30	65	80	144	144	211	211
160	GF	20	30	63	76	146	146	200	200
	KF	16	21	56	66	135	135	199	199
200	GF	15	25	55	67	127	127	174	174
	KF	13	17	47	56	126	126	188	188
250	GF	–	–	47	53	106	106	145	145
	KF	–	–	40	46	135	135	179	179
320	GF	–	–	41	45	91	91	124	124
	KF	–	–	34	38	125	125	158	158
400	GF	–	–	35	39	78	78	105	105
	KF	–	–	29	32	100	100	130	130

Guided drives DFM-N-B, NPT

Technical data

Permissible torque [Nm]

Plain-bearing guide GF and recirculating ball bearing guide KF

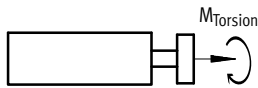

Stroke [mm]		Piston \varnothing								
		12	16	20	25	32	40	50	63	
10	GF	1.09	2.19	–	–	–	–	–	–	–
	KF	0.96	1.73	–	–	–	–	–	–	–
20	GF	0.96	1.98	2.87	4.15	7.30	–	–	–	–
	KF	0.86	1.59	2.32	3.00	4.70	–	–	–	–
25	GF	0.92	1.91	2.78	3.95	7.00	7.90	14.15	15.90	–
	KF	0.82	1.52	2.23	2.92	4.60	5.20	10.00	11.30	–
30	GF	0.88	1.82	2.67	3.80	6.70	–	–	–	–
	KF	0.78	1.47	2.18	2.85	4.55	–	–	–	–
40	GF	0.80	1.68	3.19	4.20	6.20	–	–	–	–
	KF	0.72	1.33	2.64	3.40	4.40	–	–	–	–
50	GF	0.74	1.54	2.99	3.90	5.80	6.55	11.85	13.30	–
	KF	0.66	1.29	2.55	3.30	4.25	4.80	9.30	10.50	–
80	GF	0.57	1.27	2.49	3.25	6.40	7.25	12.85	14.45	–
	KF	0.53	1.17	2.32	3.02	5.25	5.90	11.00	12.50	–
100	GF	0.51	1.13	2.23	2.90	5.80	6.55	11.65	13.10	–
	KF	0.47	1.10	2.18	2.89	5.00	5.65	10.60	12.00	–
125	GF	0.47	0.85	2.06	2.90	6.50	7.35	12.55	14.10	–
	KF	0.41	0.69	1.89	2.70	5.60	6.35	11.60	13.20	–
160	GF	0.41	0.69	1.83	2.60	5.70	6.40	11.00	12.30	–
	KF	0.33	0.48	1.62	2.20	5.25	5.95	11.00	12.40	–
200	GF	0.31	0.58	1.60	2.30	5.00	5.55	9.60	10.70	–
	KF	0.27	0.39	1.36	1.90	4.90	5.55	10.30	11.70	–
250	GF	–	–	1.36	1.80	4.10	4.60	7.98	9.06	–
	KF	–	–	1.16	1.50	5.20	5.95	9.82	11.16	–
320	GF	–	–	1.19	1.50	3.50	4.00	6.82	7.75	–
	KF	–	–	0.99	1.30	4.80	5.50	8.67	9.85	–
400	GF	–	–	1.02	1.30	3.00	3.40	5.78	6.56	–
	KF	–	–	0.84	1.10	3.90	4.40	7.17	8.15	–

Torsional backlash p

Plain-bearing guide GF and recirculating ball bearing guide KF in retracted state, without load

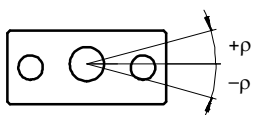

Piston \varnothing		12	16	20	25	32	40	50	63
Torsional backlash [°]	GF	0.03	0.04	0.03	0.02	0.03	0.02	0.02	0.02
	KF	0.03	0.02	0.02	0.02	0.01	0.01	0.02	0.02

Guided drives DFM-N-B, NPT

Technical data



Deflection of piston rod – Plain-bearing guide GF

Mean deflection f_1 due to bearing backlash as a function of stroke l

DFM-N-GF with 2 bearings per guide rod

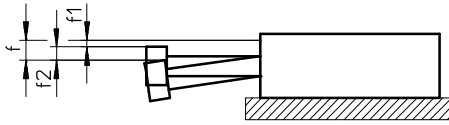

$$f = f_1 + f_2$$

f = Total deflection of piston rod

f_1 = Deflection due to bearing backlash
(with production tolerance ± 0.01 mm)

f_2 = Deflection due to lateral force

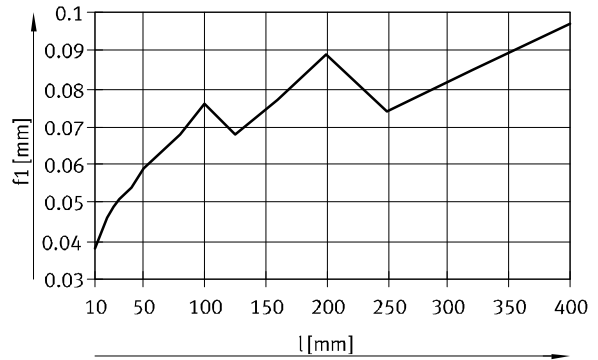

Deflection f_2 due to lateral force F as a function of stroke with plain-bearing guide GF

Stroke 50 mm

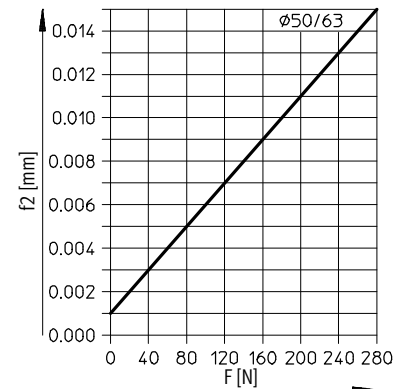
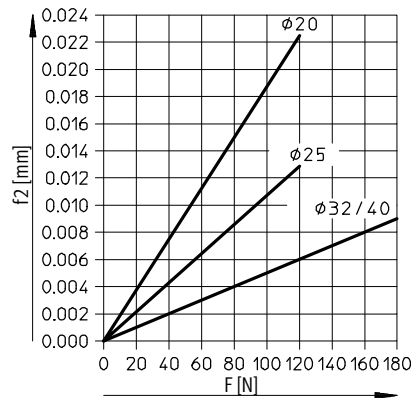
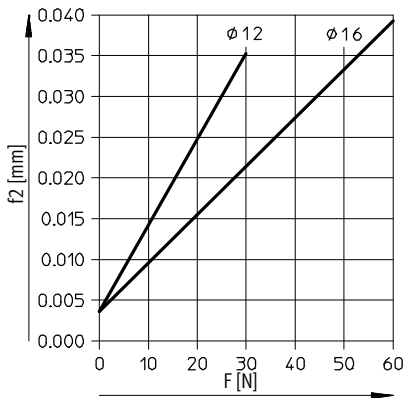

Stroke 100 mm

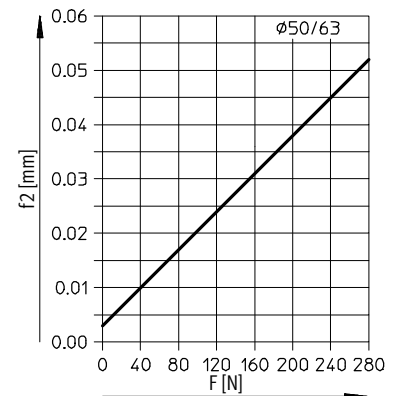
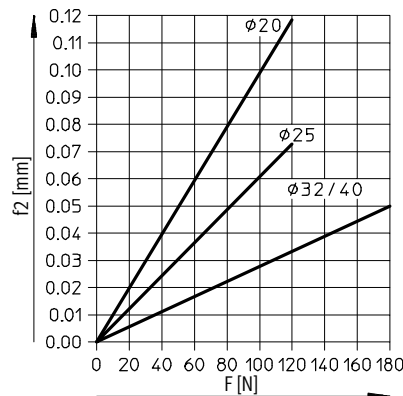
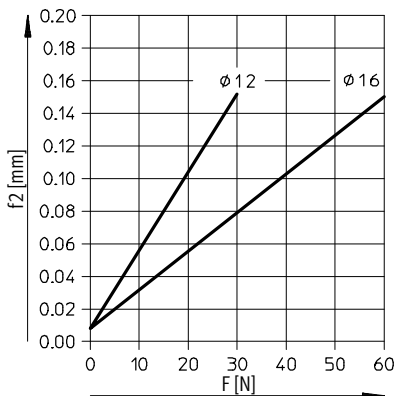

Guided drives DFM-N-B, NPT

Technical data



Deflection of piston rod – Plain-bearing guide GF

Mean deflection f_1 due to bearing backlash as a function of stroke l

DFM-N-GF with 2 bearings per guide rod

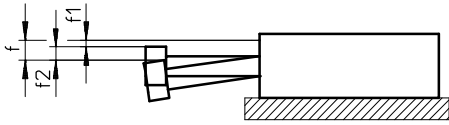

$$f = f_1 + f_2$$

f = Total deflection of piston rod

f_1 = Deflection due to bearing backlash
(with production tolerance ± 0.01 mm)

f_2 = Deflection due to lateral force

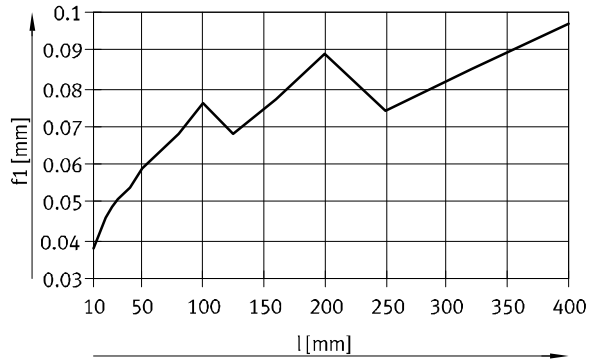

Deflection f_2 due to lateral force F as a function of stroke with plain-bearing guide GF

Stroke 200 mm

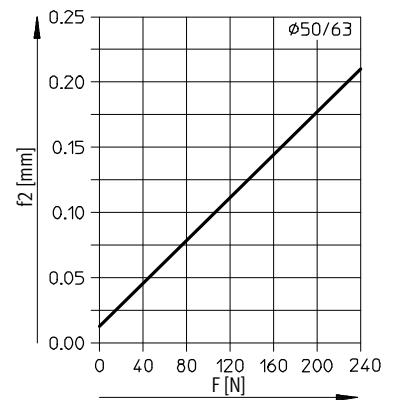
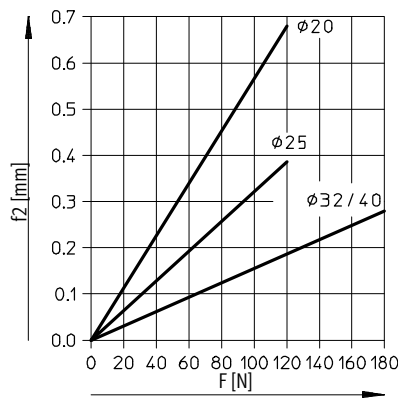
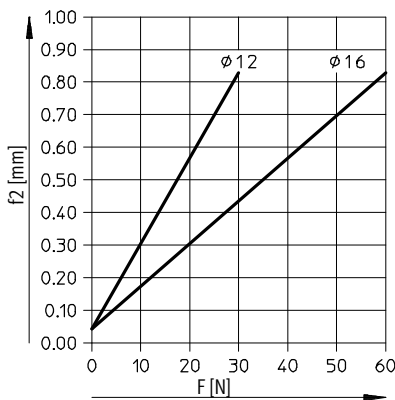

Stroke 400 mm

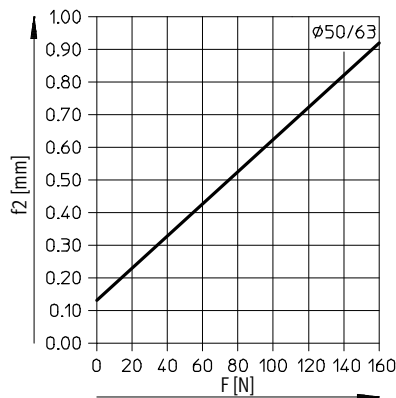
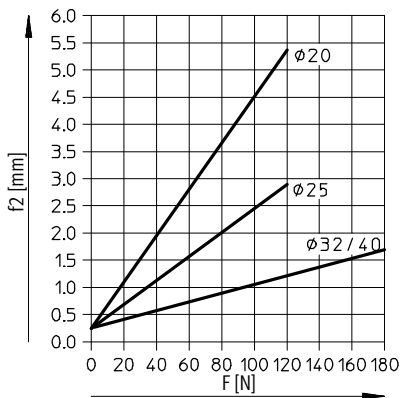

Guided drives DFM-N-B, NPT

Technical data



Deflection of piston rod – Recirculating ball bearing guide KF

Mean deflection f_1 due to bearing backlash as a function of stroke l

DFM-N-KF with 2 bearings per guide rod

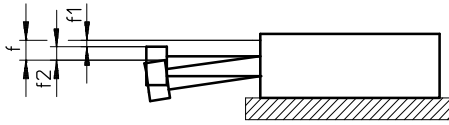

$$f = f_1 + f_2$$

f = Total deflection of piston rod

f_1 = Deflection due to bearing backlash
(with production tolerance ± 0.01 mm)

f_2 = Deflection due to lateral force

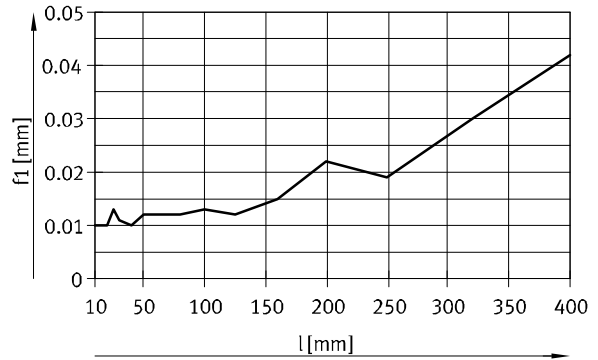

Deflection f_2 due to lateral force F as a function of stroke with recirculating ball bearing guide KF

Stroke 50 mm

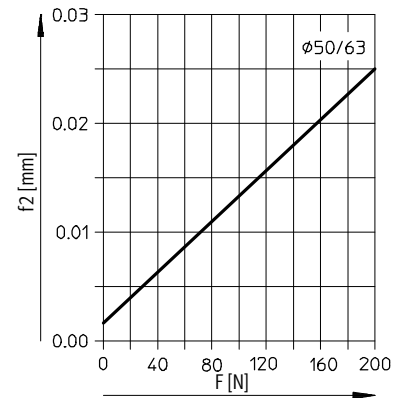
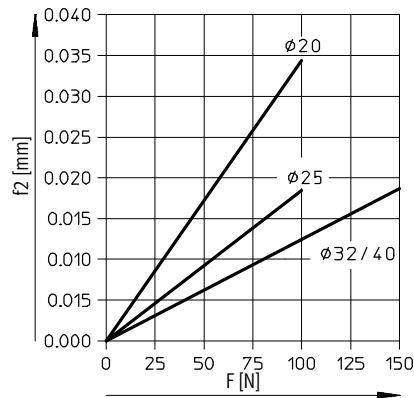
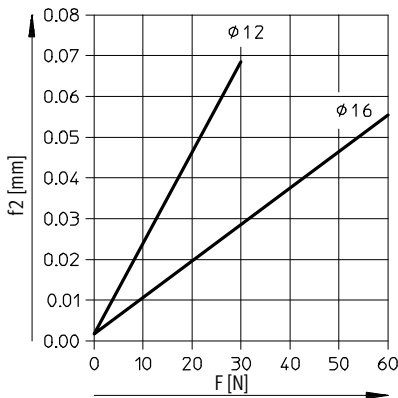

Stroke 100 mm

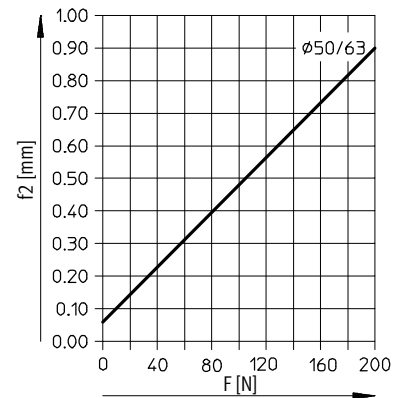
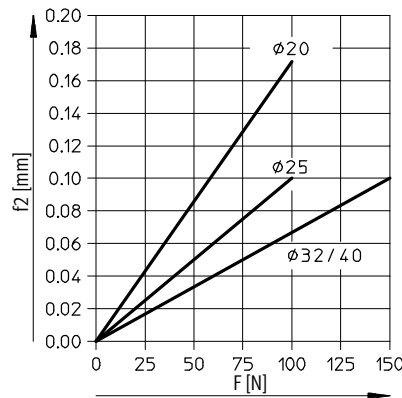
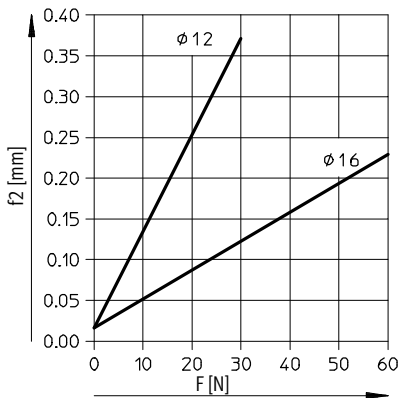

Guided drives DFM-N-B, NPT

Technical data



Deflection of piston rod – Recirculating ball bearing guide KF

Mean deflection f_1 due to bearing backlash as a function of stroke l

DFM-N-KF with 2 bearings per guide rod

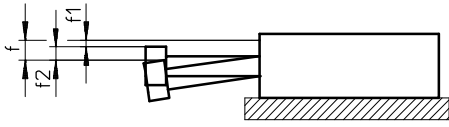

$$f = f_1 + f_2$$

f = Total deflection of piston rod

f_1 = Deflection due to bearing backlash
(with production tolerance ± 0.01 mm)

f_2 = Deflection due to lateral force

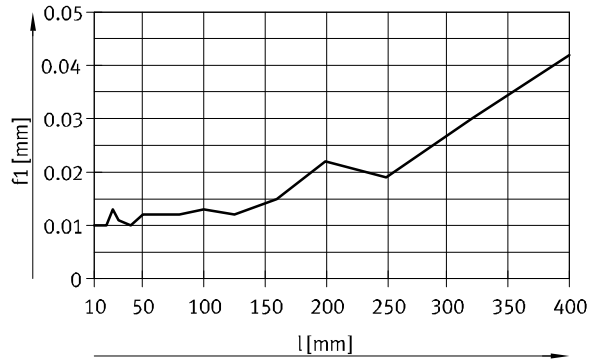

Deflection f_2 due to lateral force F as a function of stroke with recirculating ball bearing guide KF

Stroke 200 mm

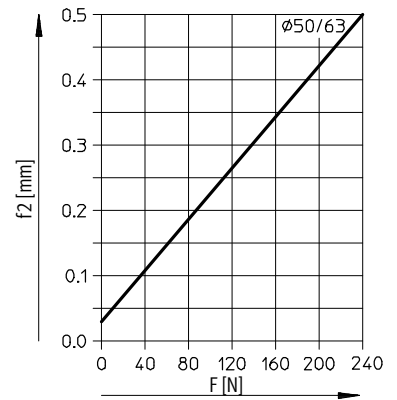
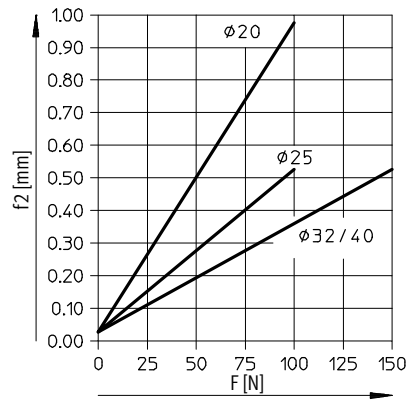
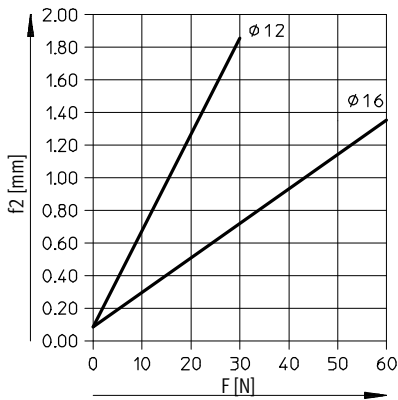

Stroke 400 mm

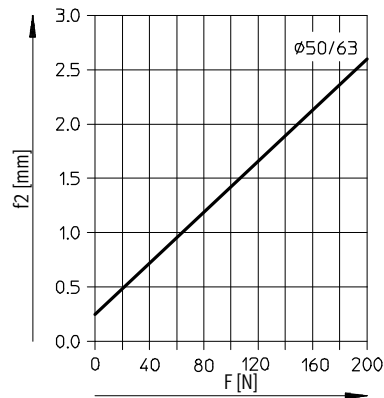
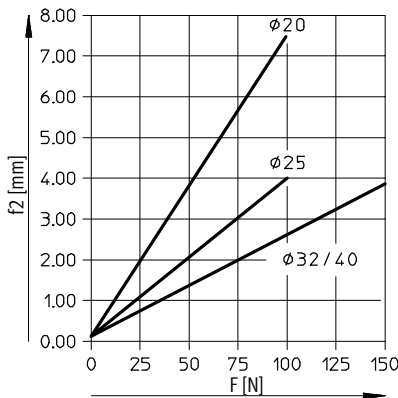

Guided drives DFM-N-B, NPT

Technical data

Used as a lifting cylinder

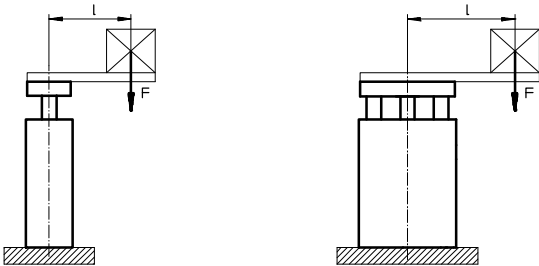

F = Longitudinal force [N]
l = Lever arm [mm]

Permissible load with plain-bearing guide GF

Stroke 40 ... 400 mm

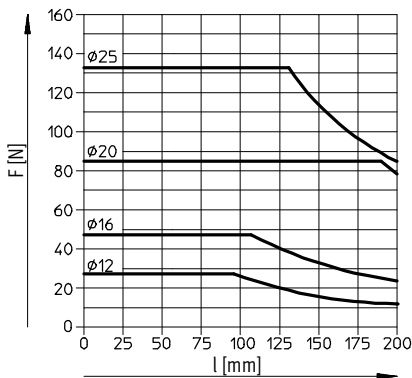

Stroke 250 ... 400 mm

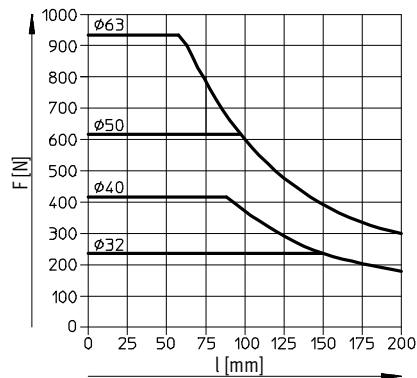

Permissible load with recirculating ball bearing guide KF

Stroke 40 ... 100 mm

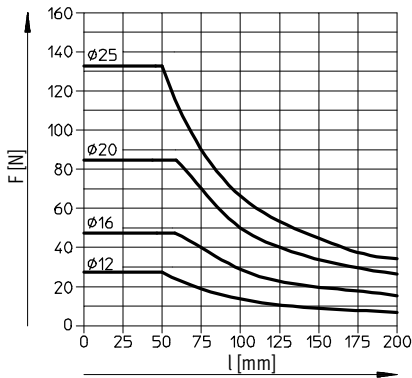

Stroke 125 ... 200 mm

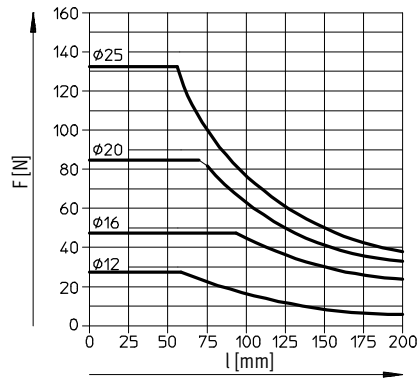

Stroke 250 ... 400 mm

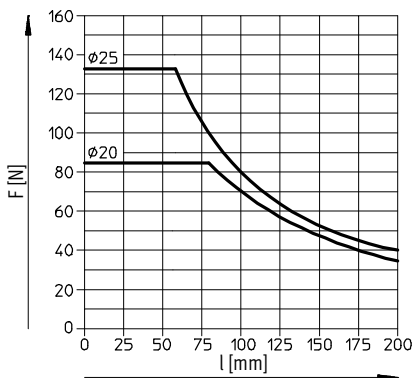

Stroke 200 ... 400 mm

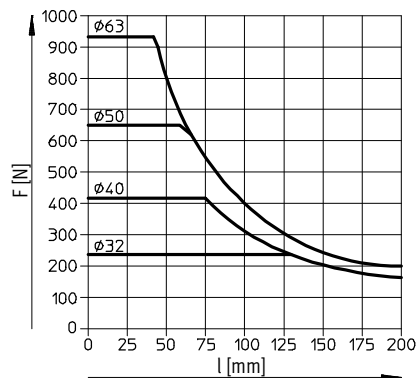

Guided drives DFM-N-B, NPT

Technical data



Permissible load m as a function of permissible speed v
Horizontal operation, cushioning YSRW

DFM-N-20-...-B-YSRW

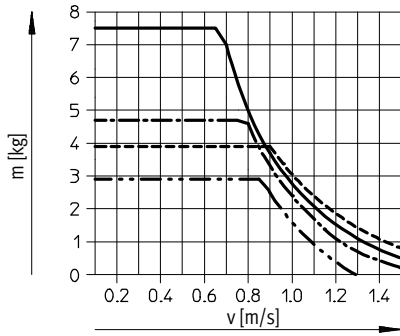

DFM-N-25-...-B-YSRW

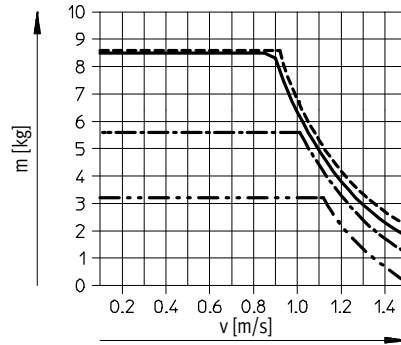

DFM-N-32-...-B-YSRW

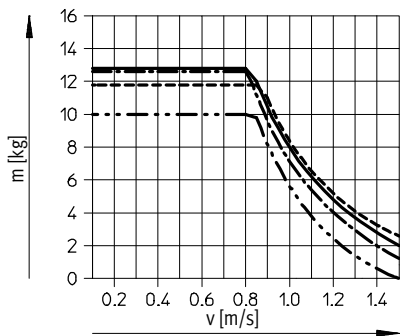

DFM-N-40-...-B-YSRW

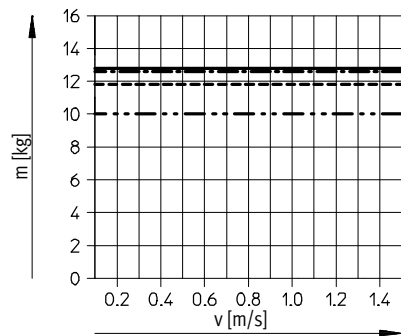

DFM-N-50-...-B-YSRW

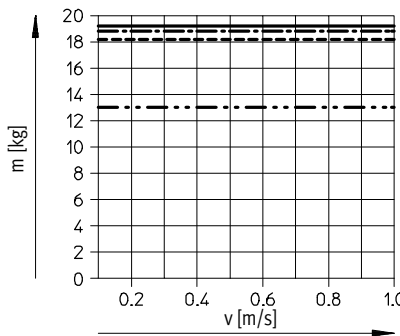

DFM-N-63-...-B-YSRW

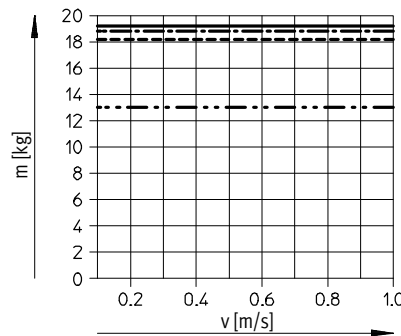

- 25 mm stroke
- 100 mm stroke
- · - · - 200 mm stroke
- · · · · 400 mm stroke

Guided drives DFM-N-B, NPT

Technical data

Permissible load m as a function of permissible speed v

Vertical operation, cushioning YSRW

DFM-N-20-...-B-YSRW

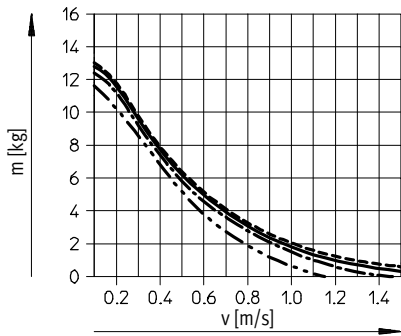

DFM-N-25-...-B-YSRW

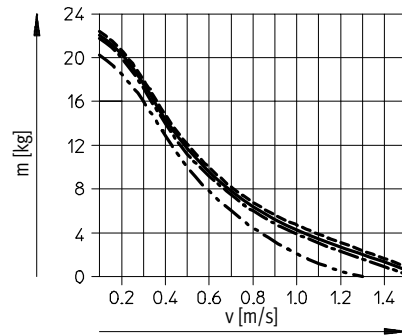

DFM-N-32-...-B-YSRW

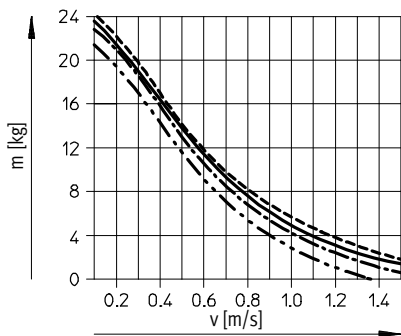

DFM-N-40-...-B-YSRW

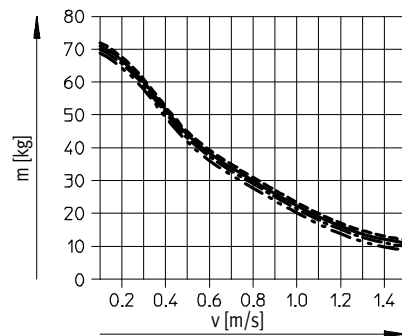

DFM-N-50-...-B-YSRW

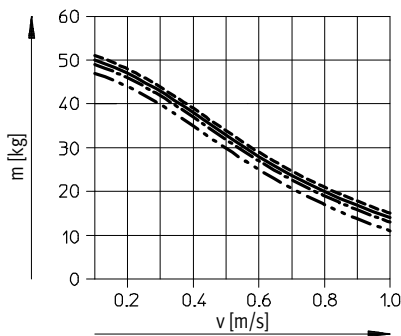

DFM-N-63-...-B-YSRW

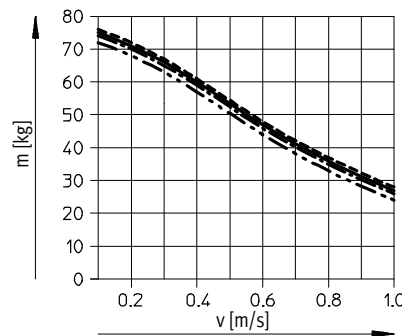

- 25 mm stroke
- 100 mm stroke
- · - · - 200 mm stroke
- · · · · 400 mm stroke

Guided drives DFM-N-B, NPT

Technical data

FESTO

Dimensions

Download CAD data → www.festo.com

∅ 12, 16 mm

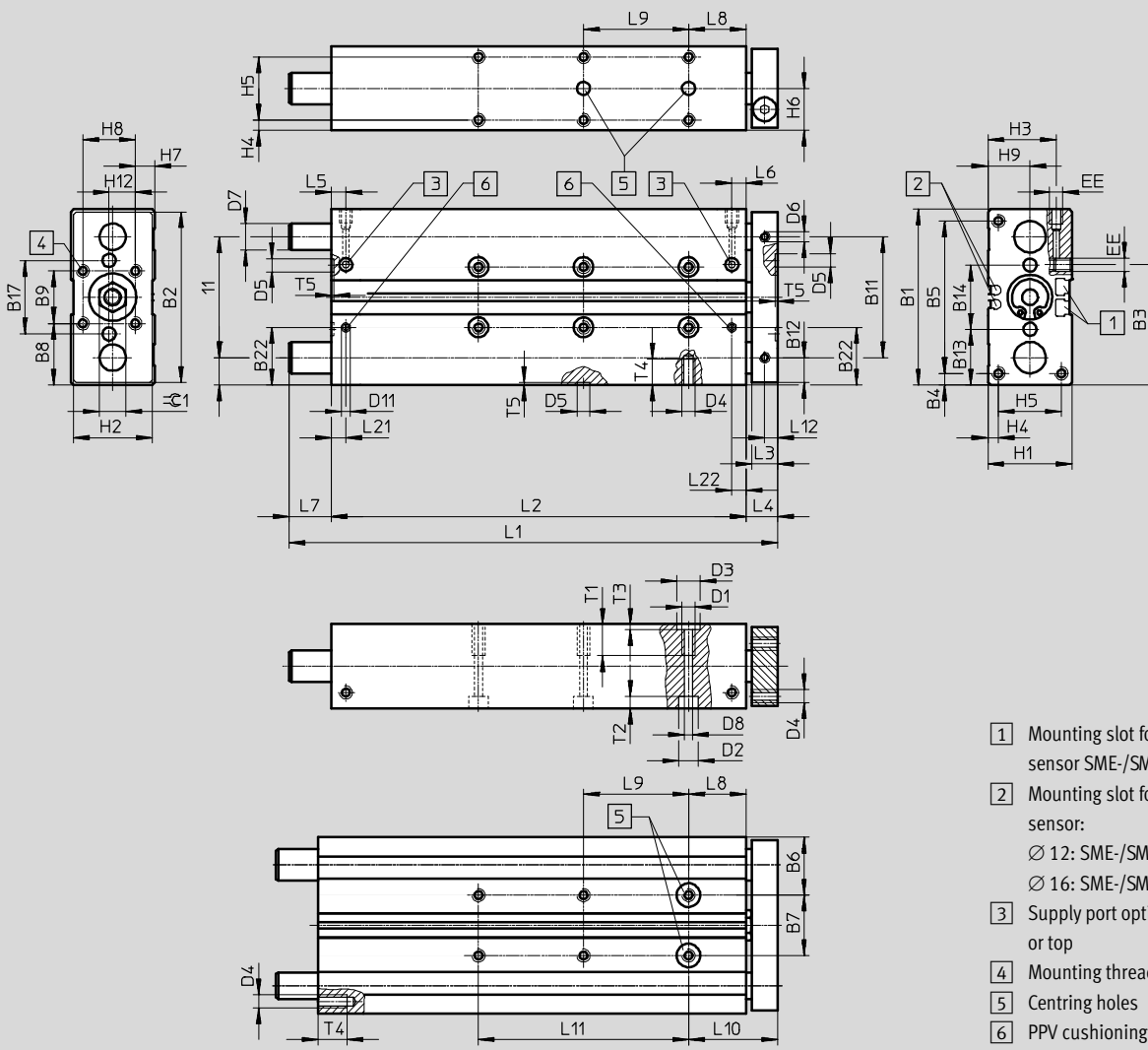

- 1) Mounting slot for proximity sensor SME-/SMT-8
- 2) Mounting slot for proximity sensor:
∅ 12: SME-/SMT-10
∅ 16: SME-/SMT-8
- 3) Supply port optionally at side or top
- 4) Mounting thread
- 5) Centring holes
- 6) PPV cushioning

∅	B1	B2	B3	B4	B5	B6	B7	B8	B9	B10	B11	B12	B13	B14	B17	B22	D1
[mm]							±0.02 ¹⁾							±0.02 ¹⁾			
12	60	58	44.2	4.5	51	20.5	19	20	20	9.5	41	8.5	19.5	21	25	–	M5
16	67	65	45	4.5	58	22	23	23.5	20	10.5	46	9.5	21.3	24.4	28	22.5	M5

∅	D2	D3	D4	D5	D6	D7		D8	D11	EE ²⁾	H1	H2	H3	H4	H5	H6	H7
	∅	∅		∅		∅	∅	∅									
[mm]		H7		H7		GF	KF	H7									
12	8	9	M4	5	M4	10 _{h8}	8 _{h6}	4.3	–	M5	28	26	24	4	20	14	4
16	7.5	9	M5	5	M4	12 _{h8}	10 _{h6}	4.3	3.3	M5	32	30	26.5	4	24	16	7.4

∅	H8	H9	H12	L3	L4	L5	L6	L8	L10	L12	L21	L22	T1	T2	T3	T4	T5	⊖C1
[mm]																		
12	20	14	10	10	13	14.8	11.2	21	34	5	–	–	10	9.4	2.1	8	1.2	10
16	20	16	10	10	12	9.8	9.3	22	34	5	9.8	9.3	12	4.6	2.1	10	1.2	10

1) Tolerance between centring holes
2) Suitable for 10-32 UNF

Guided drives DFM-N-B, NPT

Technical data

Stroke [mm]	Piston Ø [mm]									
	12					16				
	L1	L2	L7	L9 ±0.02 ¹⁾	L11	L1	L2	L7	L9 ±0.02 ¹⁾	L11
10	74	50	11	-	-	80	68	-	-	-
20	84	60	11	-	-	90	78	-	-	-
25	89	65	11	20	-	95	83	-	20	-
30	94	70	11	20	-	100	88	-	20	-
40	104	80	11	20	-	110	98	-	20	-
50	114	90	11	40	-	120	108	-	40	-
80	144	120	11	40	-	150	138	-	40	-
100	164	140	11	40	80	170	158	-	40	80
125	230	165	52	40	80	229	183	34	40	80
160	265	200	52	40	120	264	218	34	40	120
200	305	240	52	40	160	304	258	34	40	160

1) Tolerance between centring holes

 - Note

If the guide rods project beyond the housing when the unit is in its retracted end position (→ dimension L7), a recess must be provided in the mounting surface if the unit is to be mounted against a surface in order to allow the guide rods to move freely.

When using a variable stroke, the dimensions L1, L2, L7, L9 and L11 correspond to the next longest standard stroke.

Dimensions

Download CAD data → www.festo.com

AJ – Precision stroke adjustment, advanced end position

Ø 12, 16 mm

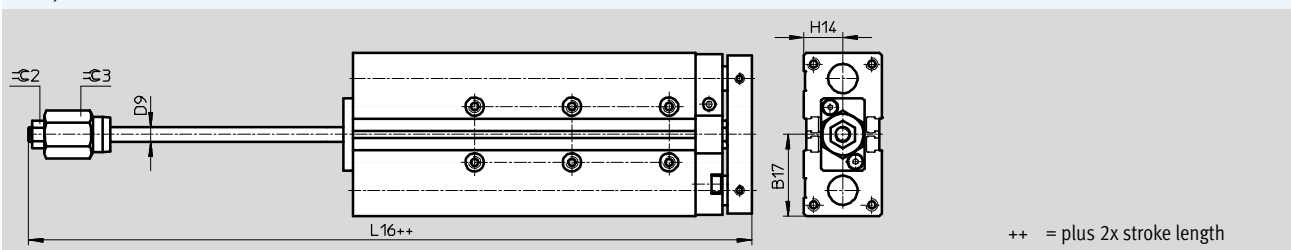

Ø	B17	D9 Ø	H14	L16	Ø2	Ø3
[mm]						
12	30.5	6	14	90.6	10	17
16	33.5	6	16	107.9	10	17

Guided drives DFM-N-B, NPT

Technical data



Dimensions

∅ 20 ... 40 mm

Download CAD data → www.festo.com

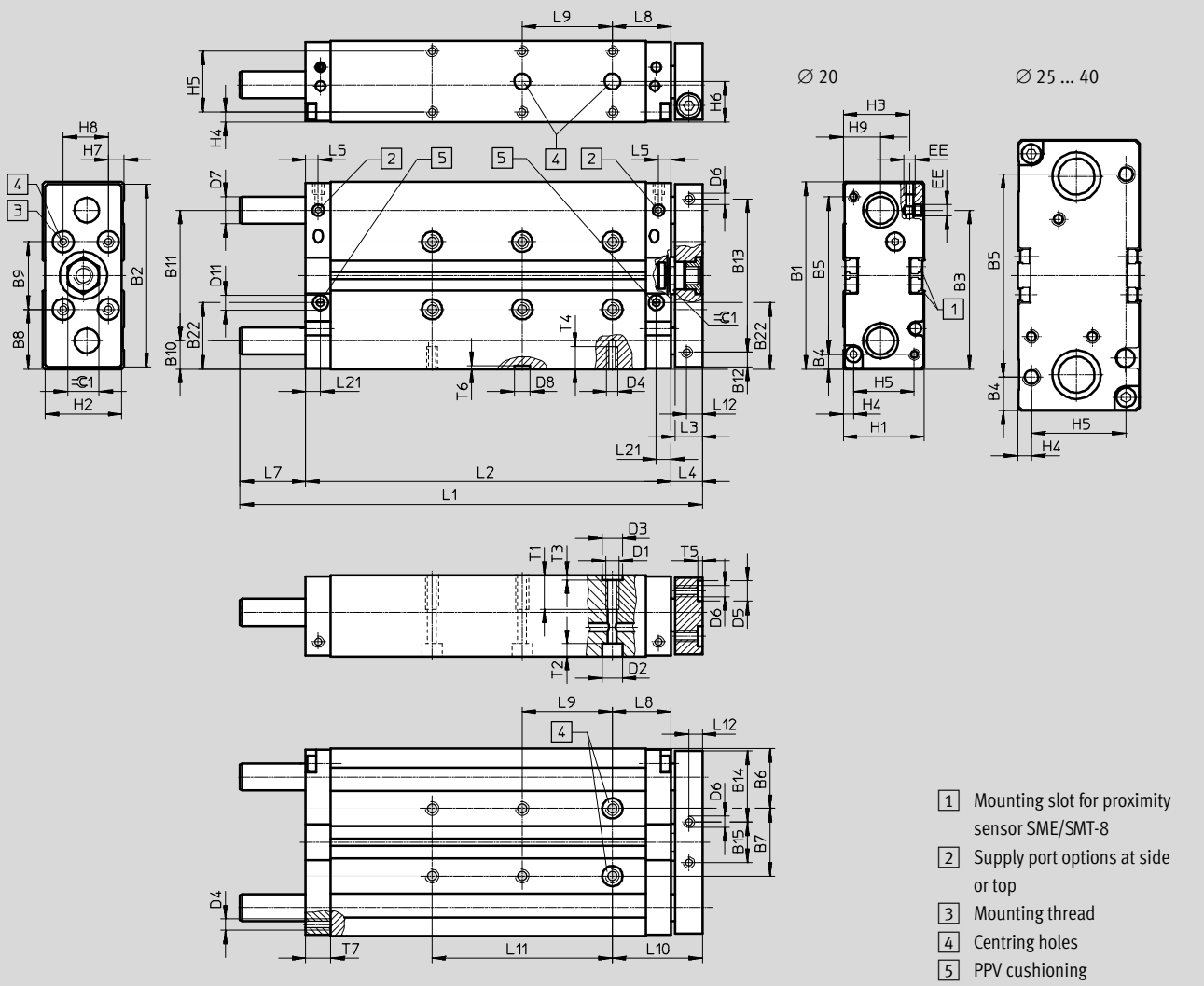

Guided drives DFM-N-B, NPT

Technical data

∅ [mm]	B1	B2	B3	B4	B5	B6	B7 ±0.02 ¹⁾	B8	B9 ±0.02 ¹⁾	B10	B11	B12	B13	B14	B15	B22	D1
20	83	81	70	6.5	70	26.5	30	26.5	30	12.5	58	6.5	68	31.5	18	28	M6
25	95	93	69	15.5	64	30	35	27.5	40	13.5	68	12.5	68	32.5	28	32	M6
32	110	108	79.5	20	70	33.5	43	35	40	16	78	15	78	41	26	38	M8
40	120	118	85.5	15	90	34.5	51	35	50	16	88	15	88	41	36	41.5	M8

∅ [mm]	D2 ∅	D3 ∅ H7	D4	D5 ∅ H7	D6 ∅	D7 ∅		D8 ∅ H7	D11 ∅	EE	H1	H2	H3	H4	H5	H6	H7
						GF	KF										
20	9	9	M5	9	M5	14	12	7	8.5	M5 ²⁾	36	34	28.5	4.5	27	18	7
25	9	9	M6	9	M6	16	14	7	8.8	1/8NPT	44	42	34	4.5	35	22	12
32	11	12	M6	9	M6	20	16	9	8.8	1/8NPT	49	47	37	6	37	24.5	8.5
40	11	12	M8	9	M6	20	16	9	8.8	1/8NPT	54	52	41.5	6	42	27	10

∅ [mm]	H8	H9	L3	L4	L5	L8	L10	L12	L21	T1	T2	T3	T4	T5	T6	T7	∅C1
20	20	16.5	12	14	6	26	40	6	6.5	12	5.7	2.1	10	2.1	1.6	11	14
25	20	19	12	14	8.5	26	40	6	8.5	15	5.7	2.1	12	2.1	1.6	15	17
32	30	21	14	16	9	29	45	7	9	20	6.8	2.6	11	2.1	2.1	15	17
40	30	26	14	16	8.5	29	45	7	9.5	20	6.8	2.6	16	2.1	2.1	15	17

Stroke [mm]	Piston ∅ [mm]																				
	20					25					32					40					
	L1	L2	L7	L9 ±0.02 ¹⁾	L11	L1	L2	L7	L9 ±0.02 ¹⁾	L11	L1	L2	L7	L9 ±0.02 ¹⁾	L11	L1	L2	L7	L9 ±0.02 ¹⁾	L11	
20	105	82	9	20	-	111	90	7	20	-	118	95	7	20	-	-	96	-	-	-	
25	110	87				116	95				123	100				123	101	6	20		
30	115	92				121	100				133	105				-	106	-	-		
40	135	102				141	110				143	115				12	116	-	-		
50	145	112	19	40	-	151	120	17	40	-	153	125	12	40	-	153	126	11	40	-	
80	185	142				196	150				208	155				208	156	36			
100	205	162	29	40	80	216	170	32	40	80	228	175	37	40	80	228	176	36	40	-	
125	257	187				271	195				283	200				283	201				
160	292	222	56	40	-	120	306	230	62	40	120	318	235	67	40	120	318	236	66	40	120
200	332	262				160	346	270			160	358	275			160	358	276			
250	472	312				200	476	320			200	483	325			200	483	326			
320	542	382				240	546	390			240	553	395			240	553	396			141
400	622	462	146	40	-	320	626	470	142	40	320	633	475	142	40	320	633	476	141	40	320

1) Tolerance between centring holes

2) Suitable for 10-32 UNF

• - Note: This product conforms to ISO 1179-1 and to ISO 228-1

- Note

If the guide rods project beyond the housing when the unit is in its retracted end position (→ dimension L7), a recess must be provided in the mounting surface if the unit is to be mounted against a surface in order to allow the guide rods to move freely.

When using a variable stroke, the dimensions L1, L2, L7, L9 and L11 correspond to the next longest standard stroke.

Guided drives DFM-N-B, NPT

Technical data

Dimensions

Download CAD data → www.festo.com

YSRW – Self-adjusting cushioning

Ø 20 ... 40 mm

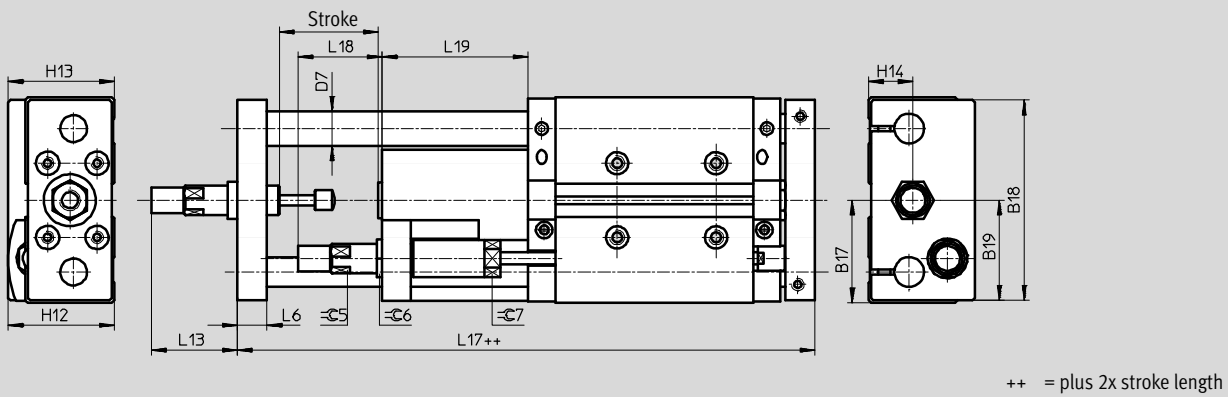

AJ/EJ – Precision stroke adjustment, advanced end position and retracted end position

Ø 20 ... 40 mm

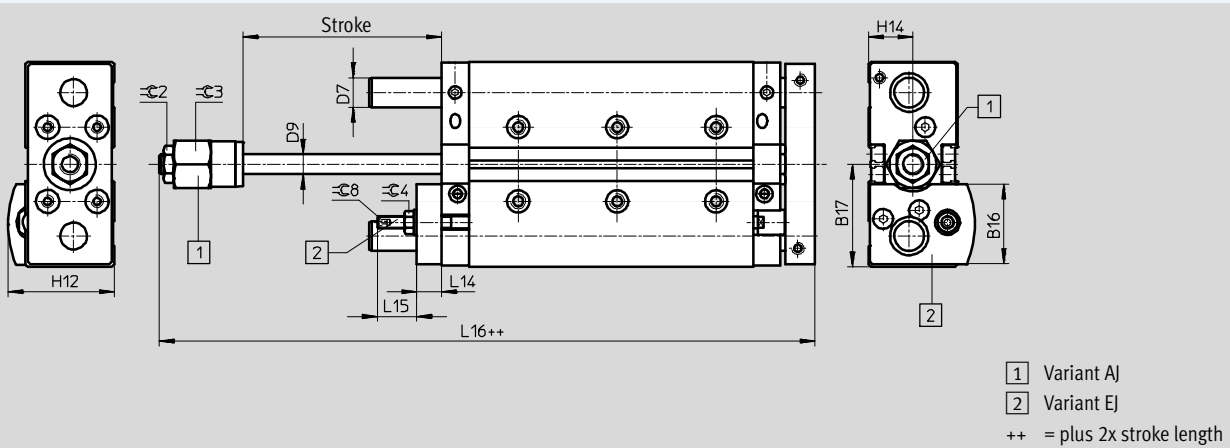

Guided drives DFM-N-B, NPT

Technical data

∅ [mm]	B16	B17	B18	B19	D7 ∅		D9 ∅	H12	H13	H14	L6	L13	L14
					GF	KF							
20	32.5	41.5	81	40.5	14	12	8	43	43	18	12	36.5	10
25	38.6	47.5	90	45	16	14	10	49.5	50.5	22	14	43	12
32	43.4	55	105	52.5	20	16	12	56.5	56	24.5	16	52	12
40	46.2	60	116	58	20	16	12	62.5	63.5	27	16	72	12

∅ [mm]	L15	L16	L17	L18	L19	≈C2	≈C3	≈C4	≈C5	≈C6	≈C7	≈C8
20	16	110	153.5	34	59	13	19	8	11	15	13	2.5
25	23.5	119.5	176.5	37.5	71	17	24	13	13	17	16	4
32	18.5	129.5	190.5	48.5	76	17	30	13	15	17	19	4
40	18.5	132	209.5	55.5	95	17	30	13	20	22	27	4

Guided drives DFM-N-B, NPT

Technical data

FESTO

Dimensions

∅ 50 ... 63 mm

Download CAD data → www.festo.com

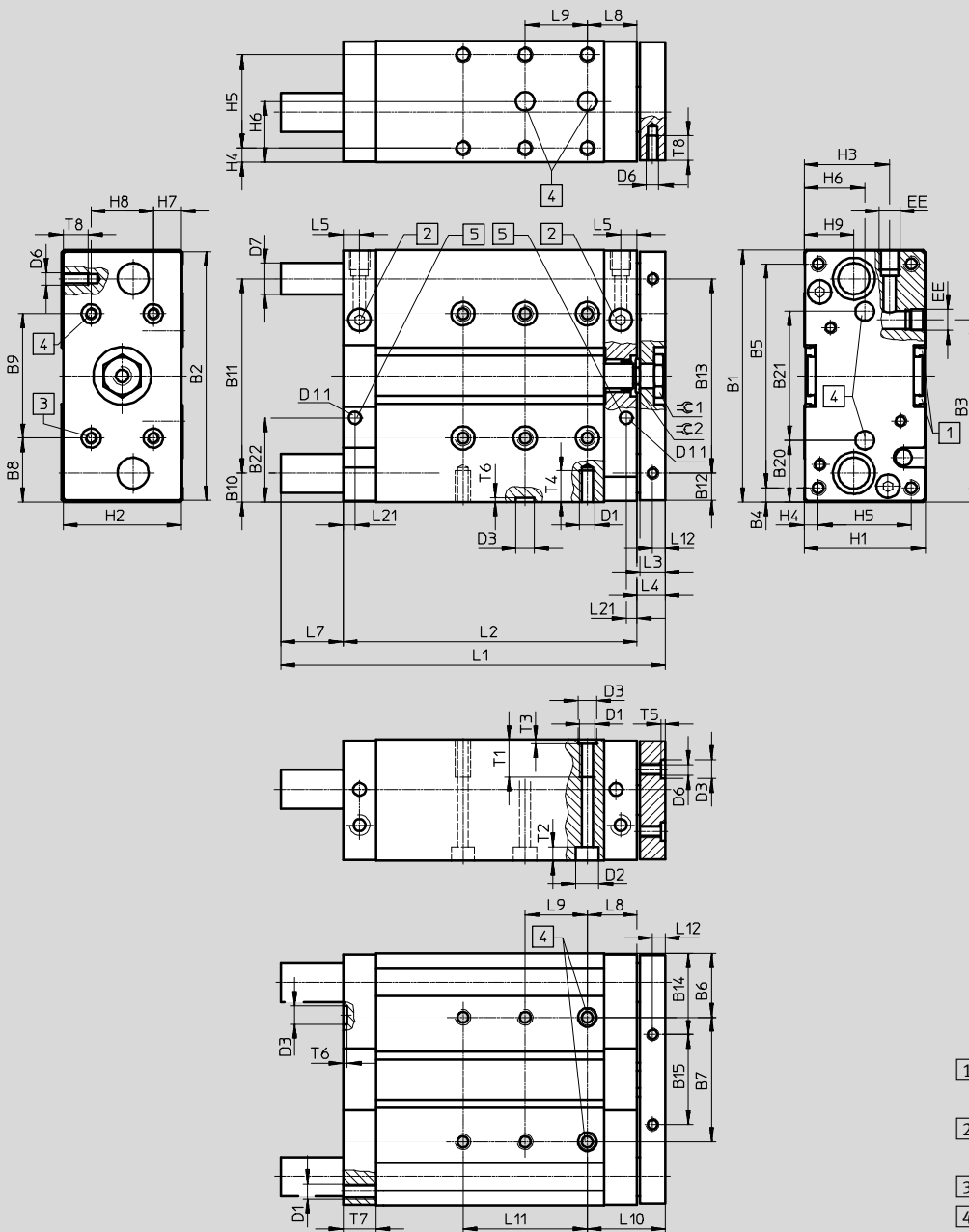

- 1 Mounting slot for proximity sensor
- 2 Supply port options at side or top
- 3 Mounting thread
- 4 Centring holes
- 5 PPV cushioning

Guided drives DFM-N-B, NPT

Technical data

∅	B1	B2	B3	B4	B5	B6	B7	B8	B9	B10	B11	B12	B13	B14	B15	B20	B21
[mm]							±0.02 ¹⁾		±0.02 ¹⁾								±0.02 ¹⁾
50	148	146	104.5	19	110	42	64	44	60	19	110	18	110	52	42	40	68
63	162	160	116.5	9	144	41	80	41	80	18.5	125	17.5	125	51	58	39.5	83

∅	B22	D1	D2	D3	D6	D7		D11	EE ²⁾	H1	H2	H3	H4	H5	H6	H7	H8
[mm]			∅	∅	∅	GF	KF	∅									
50	52.5	M8	11	12	M8	25	20	8.8	1/4NPT	64	62	48.5	7	50	32	12	40
63	53.5	M10	15	12	M8	25	20	8.8	1/4NPT	78	76	54.5	9	60	39	19	40

∅	H9	L3	L4	L5	L8	L10	L12	L21	T1	T2	T3	T4	T5	T6	T7	T8	≈C1	≈C2
[mm]																		
50	29	16	18	11.5	32	50	8	11.5	20	6.8	2.6	16	2.6	2.6	21	16	24	19
63	32	16	18	10.5	32	50	8	10.5	24	9	2.6	20	2.6	2.6	21	16	24	19

Stroke [mm]	Piston ∅ [mm]									
	50					63				
	L1	L2	L7	L9 ±0.02 ¹⁾	L11	L1	L2	L7	L9 ±0.02 ¹⁾	L11
25	137	113	6	20	-	137	114	5	20	-
50	177	138	21	177		139	20			
80	227	168	41	40	80	227	169	40	40	80
100	247	188				247	189			
125	293	213	62	40	80	293	214	61	40	120
160	328	248				120	328			
200	368	288	139	40	80	160	368	289	138	200
250	495	338				200	495	339		
320	565	408	139	40	80	240	565	409	138	320
400	645	488				320	645	489		

1) Tolerance between centring holes

2) Suitable for 10-32 UNF

· || - Note: This product conforms to ISO 1179-1 and to ISO 228-1

 Note

Since the guide rods project beyond the housing when the unit is in its retracted end position (→ dimension L7), a recess must be provided in the mounting surface if the unit is to be mounted against a surface in order to allow the guide rods to move freely.

When using a variable stroke, the dimensions L1, L2, L7, L9 and L11 correspond to the next longest standard stroke.

Guided drives DFM-N-B, NPT

Technical data



Dimensions

Download CAD data → www.festo.com

YSRW – Self-adjusting cushioning

∅ 50 ... 63 mm

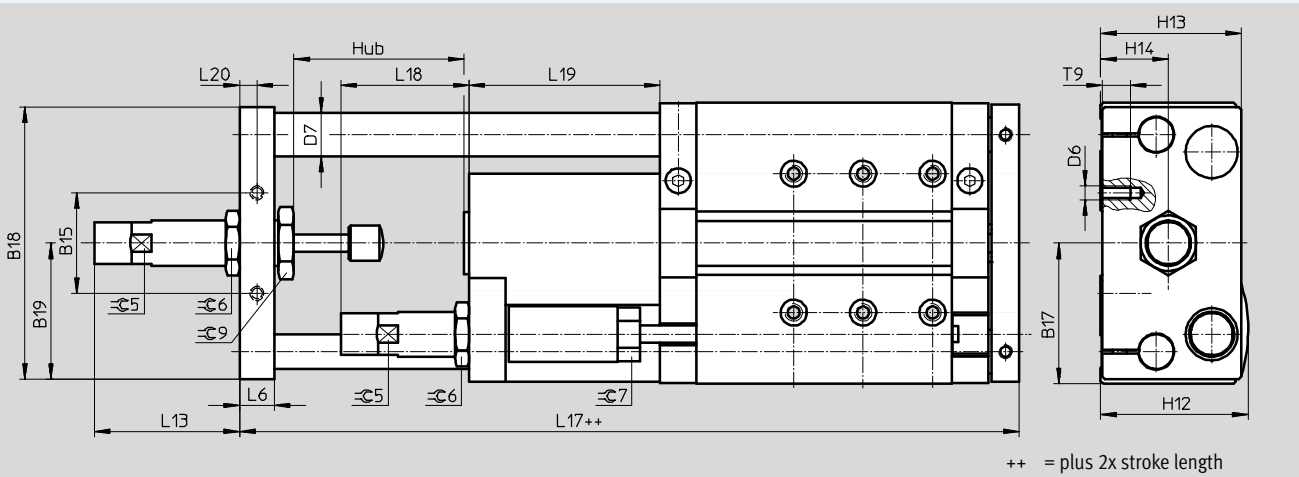

A/EJ – Precision stroke adjustment, advanced end position and retracted end position

∅ 50 ... 63 mm

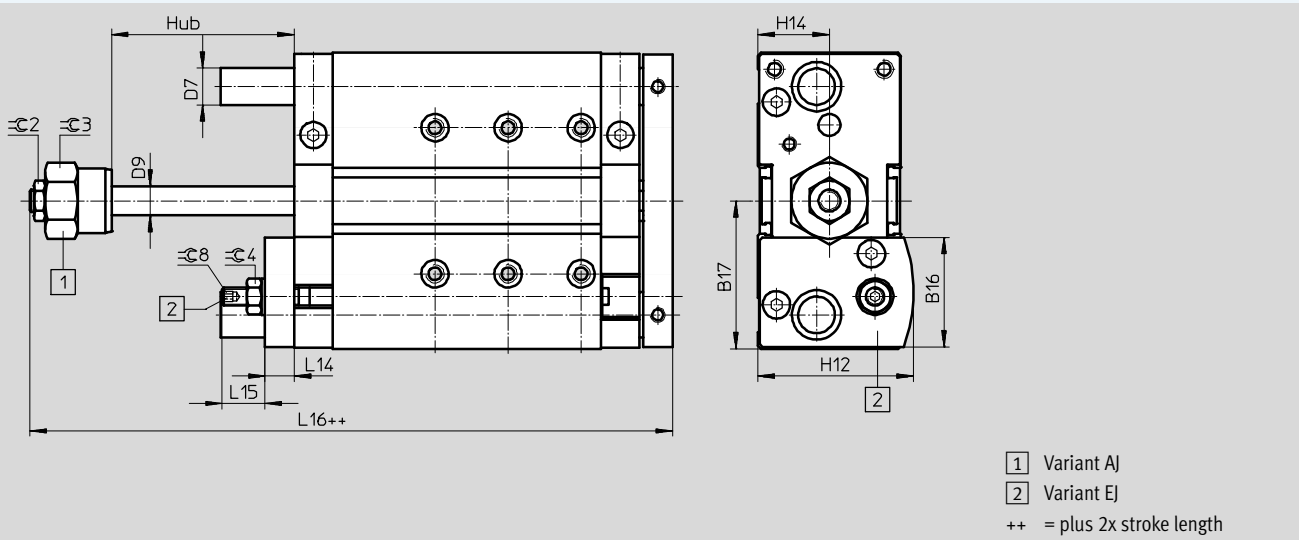

∅	B15	B16	B17	B18	B19	D6	D7		D9	H12	H13	H14	L6	L13	L14
							∅	∅							
[mm]							GF	KF							
50	42	57.6	74	157	72	M8	25	20	16	74	71	32	16	67.6	16
63	58	60	81	144	78.5	M8	25	20	16	81	81	39	20	83.3	16

∅	L15	L16	L17	L18	L19	L20	T9	C2	C3	C4	C5	C6	C7	C8	C9
50	24.5	152.1	226.4	58.5	93	8	16	19	36	17	20	27	22	5	30
63	23.5	151.8	249.2	74	110	10	16	19	36	17	24	32	27	5	36

Guided drives DFM-N-B, NPT

Ordering data – Standard types

Ordering data – Plain-bearing guide GF						
Stroke [mm]	Part No.	Type	Part No.	Type	Part No.	Type
	Ø 12 mm		Ø 16 mm		Ø 20 mm	
10	570547	DFM-N-12-10-B-P-A-GF	570555	DFM-N-16-10-B-P-A-GF	–	–
20	570548	DFM-N-12-20-B-P-A-GF	570556	DFM-N-16-20-B-P-A-GF	570563	DFM-N-20-20-B-P-A-GF
25	570549	DFM-N-12-25-B-P-A-GF	570557	DFM-N-16-25-B-P-A-GF	570564	DFM-N-20-25-B-P-A-GF
30	570550	DFM-N-12-30-B-P-A-GF	570558	DFM-N-16-30-B-P-A-GF	570565	DFM-N-20-30-B-P-A-GF
40	570551	DFM-N-12-40-B-P-A-GF	570559	DFM-N-16-40-B-P-A-GF	570566	DFM-N-20-40-B-P-A-GF
50	570552	DFM-N-12-50-B-P-A-GF	570560	DFM-N-16-50-B-P-A-GF	570567	DFM-N-20-50-B-P-A-GF
80	570553	DFM-N-12-80-B-P-A-GF	570561	DFM-N-16-80-B-P-A-GF	570568	DFM-N-20-80-B-P-A-GF
100	570554	DFM-N-12-100-B-P-A-GF	570562	DFM-N-16-100-B-P-A-GF	570569	DFM-N-20-100-B-P-A-GF
125	–	–	–	–	–	–
160	–	–	–	–	–	–
200	–	–	–	–	–	–
	Ø 25 mm		Ø 32 mm		Ø 40 mm	
10	–	–	–	–	–	–
20	570570	DFM-N-25-20-B-P-A-GF	570577	DFM-N-32-20-B-P-A-GF	–	–
25	570571	DFM-N-25-25P-A-GF	570578	DFM-N-32-25-B-P-A-GF	570587	DFM-N-40-25-B-P-A-GF
30	570572	DFM-N-25-30-B-P-A-GF	570579	DFM-N-32-30-B-P-A-GF	–	–
40	570573	DFM-N-25-40-B-P-A-GF	570580	DFM-N-32-40-B-P-A-GF	–	–
50	570574	DFM-N-25-50-B-P-A-GF	570581	DFM-N-32-50-B-P-A-GF	570588	DFM-N-40-50-B-P-A-GF
80	570575	DFM-N-25-80-B-P-A-GF	570582	DFM-N-32-80-B-P-A-GF	570589	DFM-N-40-80-B-P-A-GF
100	570576	DFM-N-25-100-B-P-A-GF	570583	DFM-N-32-100-B-P-A-GF	570590	DFM-N-40-100-B-P-A-GF
125	–	–	570584	DFM-N-32-125-B-P-A-GF	570591	DFM-N-40-125-B-P-A-GF
160	–	–	570585	DFM-N-32-160-B-P-A-GF	570592	DFM-N-40-160-B-P-A-GF
200	–	–	570586	DFM-N-32-200-B-P-A-GF	570593	DFM-N-40-200-B-P-A-GF
	Ø 50 mm		Ø 63 mm			
10	–	–	–	–		
20	–	–	–	–		
25	570594	DFM-N-50-25-B-P-A-GF	570601	DFM-N-63-25-B-P-A-GF		
30	–	–	–	–		
40	–	–	–	–		
50	570595	DFM-N-50-50-B-P-A-GF	570602	DFM-N-63-50-B-P-A-GF		
80	570596	DFM-N-50-80-B-P-A-GF	570603	DFM-N-63-80-B-P-A-GF		
100	570597	DFM-N-50-100-B-P-A-GF	570604	DFM-N-63-100-B-P-A-GF		
125	570598	DFM-N-50-125-B-P-A-GF	570605	DFM-N-63-125-B-P-A-GF		
160	570599	DFM-N-50-160-B-P-A-GF	570606	DFM-N-63-160-B-P-A-GF		
200	570600	DFM-N-50-200-B-P-A-GF	570607	DFM-N-63-200-B-P-A-GF		

Guided drives DFM-N-B, with plain-bearing guide GF, NPT



Ordering data – Modular products

Ordering table											
Size	12	16	20	25	32	40	50	63	Condi- tions	Code	Enter code
M Module No.	529119	529120	532316	532317	532318	532319	534769	534770			
Function	Guided drive									DFM	DFM
Thread	NPT thread									N	-N
Piston \varnothing [mm]	12	16	20	25	32	40	50	63		-...	
Stroke [mm]	10	10	-	-	-	-	-	-		-...	
	20	20	20	20	20	-	-	-		-...	
	25	25	25	25	25	25	25	25		-...	
	30	30	30	30	30	-	-	-		-...	
	40	40	40	40	40	-	-	-		-...	
	50	50	50	50	50	50	50	50		-...	
	80	80	80	80	80	80	80	80		-...	
	100	100	100	100	100	100	100	100		-...	
	125	125	125	125	125	125	125	125		-...	
	160	160	160	160	160	160	160	160		-...	
	200	200	200	200	200	200	200	200		-...	
		-	-	250	250	250	250	250	250		-...
	-	-	320	320	320	320	320	320		-...	
	-	-	400	400	400	400	400	400		-...	
Variable stroke [mm]	10 ... 200		20 ... 400			25 ... 400			1	-...	
Generation	B series									-B	-B
Cushioning	Flexible cushioning rings/pads at both ends									-P	
	- Pneumatic cushioning, adjustable at both ends									2	-PPV
Position sensing	Via proximity sensor									-A	-A
Guide	Plain-bearing guide									-GF	-GF

1 ... Not with precision adjustment AJ

2 **PPV** Not with precision adjustment AJ, EJ

M Mandatory data

O Options

Transfer order code

DFM - **N** - - - **B** - - **A** - **GF**

Guided drives DFM-N-B, with plain-bearing guide GF, NPT

Ordering data – Modular products

Ordering table											
Size	12	16	20	25	32	40	50	63	Condi- tions	Code	Enter code
<input type="checkbox"/> Temperature resistance	Heat-resistant seals up to max. 120 °C								<input type="checkbox"/>	S6	
<input type="checkbox"/> Precision adjustment advanced	Precision adjustment into the end positions, advanced									-AJ	
<input type="checkbox"/> Precision adjustment retracted	-	-	Precision adjustment into the end positions, retracted							-EJ	
<input type="checkbox"/> Accessories	Supplied separately									ZUB-	ZUB-
<input type="checkbox"/> Slot cover for sensor slot	1 ... 10									...S	
<input type="checkbox"/> Proximity sensor	With cable, 2.5 m									...G	
	Contactless with cable, 2.5 m									...I	

S6 Not with precision adjustment AJ, EJ

- Mandatory data
- Options

Transfer order code

- - - **ZUB** -

Guided drives DFM-B, with recirculating ball bearing guide KF, NPT



Ordering data – Modular products

Ordering table												
Size	12	16	20	25	32	40	50	63	Condi- tions	Code	Enter code	
M Module No.	529119	529120	532316	532317	532318	532319	534769	534770				
Function	Guided drive									DFM	DFM	
Thread	NPT thread									N	-N	
Piston \varnothing [mm]	12	16	20	25	32	40	50	63		-...		
Stroke [mm]	10	10	-	-	-	-	-	-		-...		
	20	20	20	20	20	-	-	-		-...		
	25	25	25	25	25	25	25	25		-...		
	30	30	30	30	30	-	-	-		-...		
	40	40	40	40	40	-	-	-		-...		
	50	50	50	50	50	50	50	50		-...		
	80	80	80	80	80	80	80	80		-...		
	100	100	100	100	100	100	100	100		-...		
	125	125	125	125	125	125	125	125		-...		
	160	160	160	160	160	160	160	160		-...		
	200	200	200	200	200	200	200	200		-...		
	-	-	250	250	250	250	250	250		-...		
	-	-	320	320	320	320	320	320		-...		
-	-	400	400	400	400	400	400		-...			
Variable stroke [mm]	10 ... 200		20 ... 400			25 ... 400			1	-...		
Generation	B series									-B	-B	
Cushioning	Flexible cushioning rings/pads at both ends									-P		
	-	Pneumatic cushioning, adjustable at both ends								2	-PPV	
	-	Shock absorber, self-adjusting, progressive								3	-YSRW	
Position sensing	Via proximity sensor									-A	-A	
Guide	Recirculating ball bearing guide									-KF	-KF	

1 ... Not with precision adjustment AJ, cushioning YSRW
2 **PPV** Not with precision adjustment AJ, EJ

3 **YSRW** Not with precision adjustment AJ, EJ, since already integrated

- M** Mandatory data
- O** Options

Transfer order code

	DFM	-	N	-		-		-	B	-		-	A	-	KF
--	------------	---	----------	---	--	---	--	---	----------	---	--	---	----------	---	-----------

Guided drives DFM-B, with recirculating ball bearing guide KF, NPT

Ordering data – Modular products

Ordering table													
Size	12	16	20	25	32	40	50	63	Condi- tions	Code	Enter code		
<input type="checkbox"/> Precision adjustment advanced	Precision adjustment into the end positions, advanced									-AJ			
<input type="checkbox"/> Precision adjustment retracted	-	-	Precision adjustment into the end positions, retracted									-EJ	
Accessories	Supplied separately									ZUB-	ZUB-		
Slot cover for sensor slot	1 ... 10									...S			
Proximity sensor	With cable, 2.5 m									...G			
	Contactless with cable, 2.5 m									...I			

- Mandatory data
- Options

Transfer order code

- - ZUB -

Guided drives DFM-N-B, NPT

Accessories

FESTO

Centring sleeve ZBH

Material:
High-alloy steel

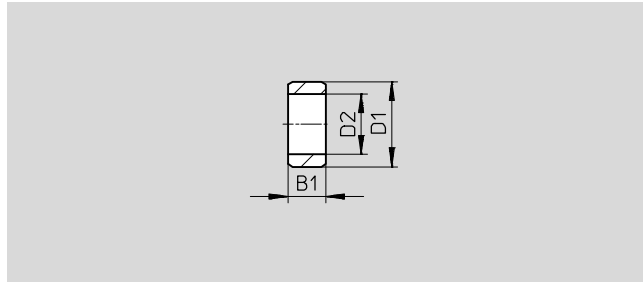

Dimensions and ordering data (repeat order)							
B1	D1	D2	CRC ¹⁾	Weight	Part No.	Type	PU ²⁾
-0.2	∅ h7	∅		[g]			
2.4	5	3.2	2	1	189652	ZBH-5	10
3	7	5.3	2	1	186717	ZBH-7	10
4	9	6.4	2	1	150927	ZBH-9	10
5	12	10.3	2	1	189653	ZBH-12	10

- 1) Corrosion resistance class 2 to Festo standard 940 070
Components subject to moderate corrosion stress. Externally visible parts with primarily decorative surface requirements which are in direct contact with a normal industrial environment or media such as coolants or lubricating agents
- 2) Packaging unit

Centring sleeves included in the scope of delivery			
DFM-N-B	Piston ∅ [mm]	Centring sleeves	
		For housing	For yoke plate
	12	2x ZBH-5, 2x ZBH-9	2x ZBH-5
	16	2x ZBH-5, 2x ZBH-9	2x ZBH-5
	20	2x ZBH-7, 2x ZBH-9	2x ZBH-9
	25	2x ZBH-7, 2x ZBH-9	2x ZBH-9
	32	2x ZBH-9, 2x ZBH-12	2x ZBH-9
	40	2x ZBH-9, 2x ZBH-12	2x ZBH-9
	50	2x ZBH-12	2x ZBH-12
	63	2x ZBH-12	2x ZBH-12

Ordering data – Slot cover for T-slot			
	Assembly	Length	Part No. Type
	Insertable from above	2x 0.5 m	151680 ABP-5-S

Guided drives DFM-N-B, NPT

Accessories

FESTO

Proximity sensors for piston $\varnothing 12$

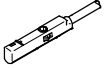
Ordering data – Proximity sensors for C-slot, magneto-resistive						Technical data → Internet: smt	
	Type of mounting	Switch output	Electrical connection, connection direction	Cable length [m]	Part No.	Type	
N/O contact							
	Insertable in the slot from above	PNP	Cable, 3-wire, in-line	2.5	551373	SMT-10M-PS-24V-E-2,5-L-OE	
			Plug M8x1, 3-pin, in-line	0.3	551375	SMT-10M-PS-24V-E-0,3-L-M8D	
			Plug M8x1, 3-pin, angled	0.3	551376	SMT-10M-PS-24V-E-0,3-Q-M8D	

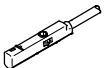
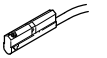
Ordering data – Proximity sensors for C-slot, magnetic reed						Technical data → Internet: sme	
	Type of mounting	Switch output	Electrical connection, connection direction	Cable length [m]	Part No.	Type	
N/O contact							
	Insertable in the slot from above	Contacting	Plug M8x1, 3-pin, in-line	0.3	551367	SME-10M-DS-24V-E-0,3-L-M8D	
			Cable, 3-wire, in-line	2.5	551365	SME-10M-DS-24V-E-2,5-L-OE	
			Cable, 2-wire, in-line	2.5	551369	SME-10M-ZS-24V-E-2,5-L-OE	
	Insertable in the slot from above	Contacting	Plug M8x1, 3-pin, in-line	0.3	173212	SME-10-SL-LED-24	
			Cable, 3-wire, in-line	2.5	173210	SME-10-KL-LED-24	

Proximity sensors for piston $\varnothing 16 \dots 63$

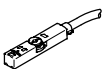
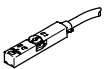

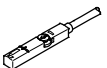
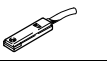
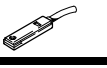
Ordering data – Proximity sensors for T-slot, magneto-resistive						Technical data → Internet: smt	
	Type of mounting	Switch output	Electrical connection	Cable length [m]	Part No.	Type	
N/O contact							
	Insertable in the slot from above, flush with cylinder profile, short design	PNP	Cable, 3-wire	2.5	574335	SMT-8M-A-PS-24V-E-2,5-OE	
			Plug M8x1, 3-pin	0.3	574334	SMT-8M-A-PS-24V-E-0,3-M8D	
			Plug M12x1, 3-pin	0.3	574337	SMT-8M-A-PS-24V-E-0,3-M12	
		NPN	Cable, 3-wire	2.5	574338	SMT-8M-A-NS-24V-E-2,5-OE	
			Plug M8x1, 3-pin	0.3	574339	SMT-8M-A-NS-24V-E-0,3-M8D	
N/C contact							
	Insertable in the slot from above, flush with cylinder profile, short design	PNP	Cable, 3-wire	7.5	574340	SMT-8M-A-PO-24V-E-7,5-OE	

Ordering data – Proximity sensors for T-slot, magnetic reed						Technical data → Internet: sme		
	Type of mounting	Switch output	Electrical connection	Cable length [m]	Part No.	Type		
N/O contact								
	Insertable in the slot from above, flush with the cylinder profile	Contacting	Cable, 3-wire	2.5	543862	SME-8M-DS-24V-K-2,5-OE		
				5.0	543863	SME-8M-DS-24V-K-5,0-OE		
			Plug M8x1, 3-pin	Cable, 2-wire	2.5	543872	SME-8M-ZS-24V-K-2,5-OE	
				0.3	543861	SME-8M-DS-24V-K-0,3-M8D		
	Insertable in the slot lengthwise, flush with the cylinder profile	Contacting	Cable, 3-wire	2.5	150855	SME-8-K-LED-24		
			Plug M8x1, 3-pin	0.3	150857	SME-8-S-LED-24		
N/C contact								
	Insertable in the slot from above, flush with the cylinder profile	Contacting	Cable, 3-wire	7.5	546799	SME-8M-DO-24V-K-7,5-OE		

Guided drives DFM-N-B, NPT

Accessories

FESTO

Ordering data – Connecting cables				Technical data → Internet: nebu		
	Electrical connection, left		Electrical connection, right	Cable length [m]	Part No.	Type
		Straight socket, M8x1, 3-pin		Cable, open end, 3-wire	2.5	541333
5					541334	NEBU-M8G3-K-5-LE3
Straight socket, M12x1, 5-pin		Cable, open end, 3-wire	2.5	541363	NEBU-M12G5-K-2.5-LE3	
			5	541364	NEBU-M12G5-K-5-LE3	
	Angled socket, M8x1, 3-pin		Cable, open end, 3-wire	2.5	541338	NEBU-M8W3-K-2.5-LE3
				5	541341	NEBU-M8W3-K-5-LE3
	Angled socket, M12x1, 5-pin		Cable, open end, 3-wire	2.5	541367	NEBU-M12W5-K-2.5-LE3
				5	541370	NEBU-M12W5-K-5-LE3

Ordering data – One-way flow control valves				Technical data → Internet: grla	
	Connection		Material	Part No.	Type
	Thread	For tubing O.D. [inch]			
	M5 ¹⁾	1/8	Plastic design ²⁾	564839	GRLA-10-32-UNF-QB-1/8-U
		5/32	Metal design ³⁾	564840	GRLA-10-32-UNF-QB-5/32-U
		1/4		564842	GRLA-10-32-UNF-QB-1/4-U
	1/8NPT	5/32		534656	GRLA-1/8-QB-5/32-U
		1/4		534658	GRLA-1/8-QB-1/4-U
		5/16		534659	GRLA-1/8-QB-5/16-U
	1/4NPT	1/4		534661	GRLA-1/4-QB-1/4-U
		5/16		534662	GRLA-1/4-QB-5/16-U
		3/8		190947	GRLA-1/4-NPT-QS-3/8-U

1) Suitable for 10-32 UNF

2) Operating pressure range -0.95 ... +8 bar

3) Operating pressure range 1 ... 9 bar

Guided drives DFM-N-B, NPT

Accessories



Adapter kit
DHAA, HAPB

Material:
Wrought aluminium alloy
Free of copper and PTFE
RoHS-compliant

 Note
The kit includes the individual mounting interface as well as the necessary mounting material.

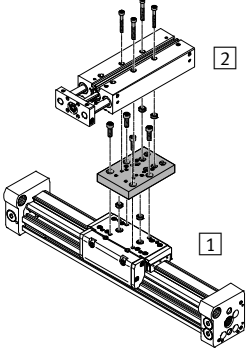
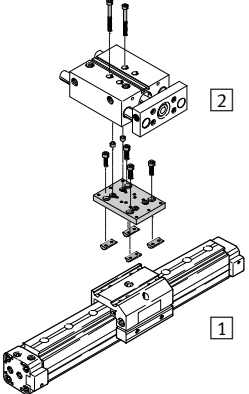
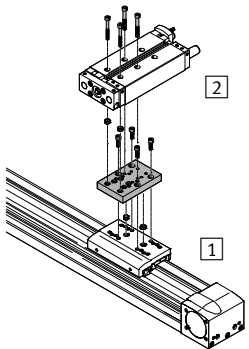
Permissible drive/drive combinations with adapter kit				Download CAD data → www.festo.com	
Combination	1	2	Adapter kit		
	Drive	Drive	CRC ¹⁾	Part No.	Type
DGC/DFM	DGC	DFM	DHAA		
	25	12, 16, 20	2	562152	DHAA-D-L-25-G7-12
	20, 25	32		562153	DHAA-D-L-32-G7-20
	25, 32, 40	40		562154	DHAA-D-L-40-G7-25
DGPL, DGE/DFM	DG...	DFM	HAPB		
	25	12, 16	2	192690	HAPB-12/16
	32 ²⁾	20, 25		192691	HAPB-20/25
	40	32, 40		192692	HAPB-32/40
EGC/DFM	EGC	DFM	DHAA		
	80	12, 16, 20	2	562152	DHAA-D-L-25-G7-12
	120	25, 32, 40		562154	DHAA-D-L-40-G7-25

1) Corrosion resistance class CRC 2 to Festo standard FN 940070
Moderate corrosion stress. Indoor applications in which condensation may occur. External visible parts with primarily decorative requirements for the surface and which are in direct contact with the ambient atmosphere typical for industrial applications.

2) Only for DGPL