



FESTO

Specification for

12019703 Volvo Cars, engine in Skövde

Date of creation
29.06.2017

**Festo components for pneumatics,
electro-pneumatics and local control**

Originator
Thorsten Weiss

Version
1.4

Festo AG & Co. KG

Telefon +49 (711) 347-2030
Telefax +49 (711) 34754-2030
E-Mail thorsten.weiss@festo.com
Ruiter Straße 82 - 84
73734 Esslingen



Table of Content

1	Document Management Information	3
2	Contact Persons at Volvo Cars and Festo AG & Co. KG.....	4
3	General engineering and design guidelines.....	5
3.1	Valve terminals	5
3.2	Service units	8
3.3	Tubing technology	11
3.4	Clamping technology	11
4	Release list overview	12
4.1	Pneumatic drives	12
4.1.1	Standard cylinders	12
4.1.2	Linear drives and slides	13
4.1.3	Rotary drives	14
4.1.4	Pin locating cylinder	14
4.1.5	Stopper and clamping cylinders	15
4.2	Electromechanical drives	16
4.3	Motors and controllers.....	16
4.4	Grippers	17
4.4.1	Parallel grippers	17
4.4.2	Radial grippers	17
4.5	Valves	18
4.5.1	Standard valves.....	18
4.5.2	Proportional valves	18
4.5.3	Flow control valves.....	19
4.6	Valve terminals	19
4.7	Vacuum technology	20
4.8	Sensors.....	20
4.8.1	Pressure sensors	20
4.8.2	Air gap sensor	21
4.8.3	Proximity sensors	21
4.9	Compressed air preparation.....	22
4.10	Pneumatic fittings system.....	23
4.11	Other pneumatic equipment	24
5	Service Units - Details.....	25
5.1	Service Unit 1 – G1/2”	25
5.2	Service Unit 2 – G3/4”	26
5.3	Service Unit 3 – G3/8”	27
6	Alphabetically list of approved products	28
7	Drawings	29



1 Document Management Information

VERSION	DATE	WHO	TYPE OF CHANGING	PAGES/CHAPTER
1.0	01.12.2013	Leif Lindahl + Thorsten Weiß / Festo	First edition	all
1.1	28.01.2014	Leif Lindahl + Thorsten Weiß / Festo	Correct typcodes of service unit	29
1.2	04.11.2015	Leif Lindahl + Thorsten Weiß / Festo	<ul style="list-style-type: none"> - delete STA / STAF - add DFSP - delete CTLU - add valves VFOF - update service unit - add index 	4.1.4 4.1.4 4.1.4 4.5 5.2 and 3.2 6
1.3	08.12.2016	Leif Lindahl + Thorsten Weiß / Festo	<ul style="list-style-type: none"> - update contact person - add rotary drives DRRD and DRVS - delete DNCE, add DSBF - move SFAM to service units - change part number for gauges MAE - delete PLN - add PUN and PAN - update service unit 	2 4.1.3 4.2 4.8 4.8, 5.2, 5.3 4.9 4.9 5.2
1.4	29.06.2017	Joakim Gustafsson + Thorsten Weiß / Festo	<ul style="list-style-type: none"> - remove DSL - add DGSL and FENG - remove EGSK, EGSP, ELGR, EGSA, DGEA, ADNE, DFME, ELGL, and CMFL - remove HGPD and HGPP - remove HGRT - remove three-point and other grippers - add VMPA valves - remove VTSA - add vacuum technology - remove SPAB and SDE1 - add SPAU - add regulators - remove VZS 	4.1.2 4.1.2 4.2 4.4.1 4.4.2 4.4.3 and 4.4.4 4.5.1 4.6 4.7 4.8.1 4.8.1 4.9 4.11



2 Contact Persons at Volvo Cars and Festo AG & Co. KG

Volvo:

Johan Schelin

Project Engineer
Volvo Car Corporation
Volvovägen 5
54187 Skövde
Tel: +46500274164
Mail: joohan.schelin@volvocars.com

Festo:

Peter Pappert

Automotive Industry
Global Key Account Manager Volvo
Festo AG & Co. KG
Rüiter Straße 82
73734 Esslingen, Germany
Tel: +49 711 347-50077
Fax: +49 711 34754-50077
Mobil: +49 172 7397372
Mail: peter.pappert@festo.com

Joakim Gustafsson

Industry Segment Manager Automotive
Festo AB
Box 14001
40020 Göteborg
Tel: +46 (705) 562326
Mail: joakim.gustafsson@festo.com

Peter Görrel

Sales Engineer
Festo AB
Diabasvägen 2
541 52 Skövde, Sweden
Tel: +46 (40) 6990640
Fax: +46 (40) 383810
Mobil: +46 (706) 055488
Mail: peter.goerrel@festo.com



3 General engineering and design guidelines

This specification defines products and automation concepts which are state of the art and ensure the availability worldwide. The availability of products includes offering additional services to Volvo.

The named contact persons are to be contacted as soon as possible during the start-up phase of the project, to determine the quantity of components to be used and together secure delivery time setup in the project.

Documentation of products and software is in English language available, also in other languages.

Nomenclature should be the same on pneumatic and electric drawings, label holder should be reference designation. Labelling should be done in drawing and on the tube.

If any conflicts occur, then specific and direct discussions must take place with Volvo/Pneumatic supplier and written permission for any deviations must be obtained.

All accessories for cylinders and valves are allowed, please see Festo main catalogue.

3.1 Valve terminals

Valve terminals (VT) must be used for piloting pneumatic actuated cylinders, clamps or other devices. The specified type of VT is the Festo MPA with CPX electrical I/O devices. When use big cylinders, diameter 160 and bigger, use two valves on the valve terminal as first choice, second choice pilot valve near the cylinder.

Valve terminals, with CPX MPA:

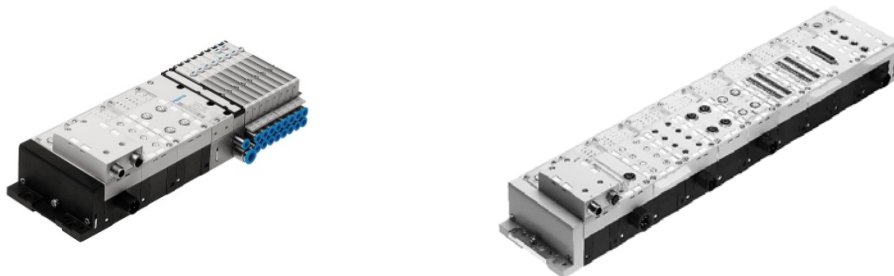

Installation guideline:

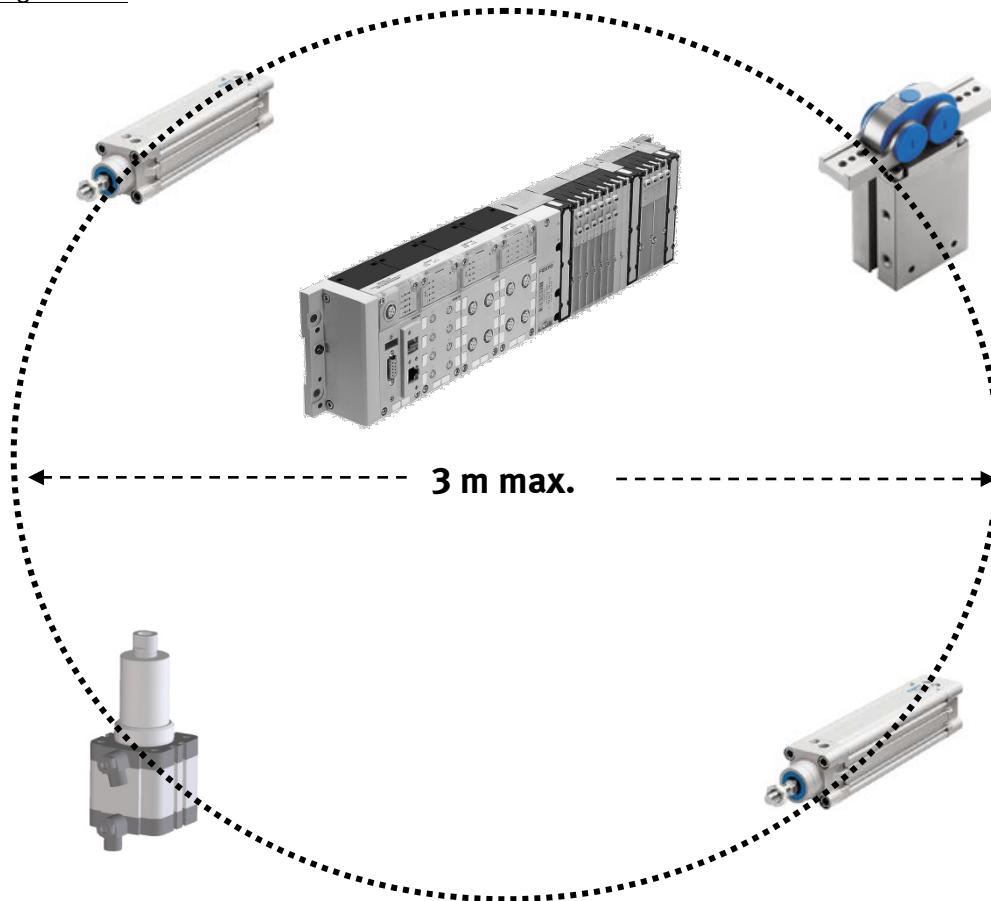

Consideration to Volvos demands of cycle times and availability, when configuring valve terminals must be taken. The VT must be installed as near as possible to the pneumatic actuators to prevent long tubes and to optimize installation costs as well as short cycle times.

Connection definitions:

Electrical connection type: M12

VT design:

VT's must be defined that 10% of the maximum numbers of I/ O and one blanking plate for a valve are free during first installation and SOP.

Recommend standard configuration for VT in fixtures:

No. of electrical input modules:	6 (max.10)
No. of pilot valves:	8 x 5/2 bistable (max.16)
Controller / field bus:	1

Electrical connection of VT:

Standard connection of VT to a Host PLC is via a standard field bus, according to project specification:

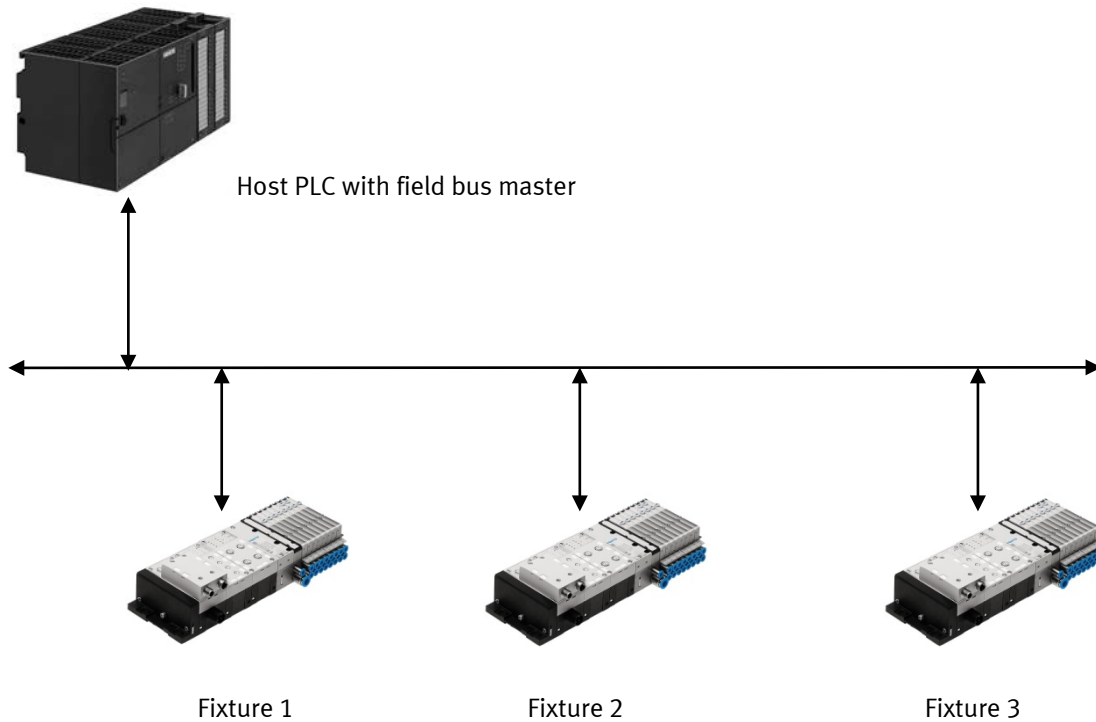



3.2 Service units

The pneumatic system must be dimensioned to have full function at a system pressure of 5 bars. The quality of the compressed air has to meet at least ISO 8573:1 class 5.

The compressed air has to be connected by an air preparation unit equipped with:

- manual cut off valve with venting (lockable with padlock)
- filter (automatic vapour draining)
- regulator
- manometer
- flow meter
- soft start valve
- venting valve (automatic)
- pressure switch

The main valve has to be marked with a sign. Signs specifying the pressure to be set have to be displayed in all places where the pressure can be adjusted.

Cylinders of dimension 8-25mm are to be made according to ISO 6432. Cylinders of dimension 32-320 mm are to be made according to ISO 6431 and VDMA 24562.

At emergency stop, the whole system has to be aired off. The emergency stop function must however not stop a machine function, where the stoppage may cause personal injury or equipment damages.

When an adjustment level is given, this must be given as a max – min levels, not only a single value.

Part number: MS6-1/2" - SE_CS.1396581 (see page 27)

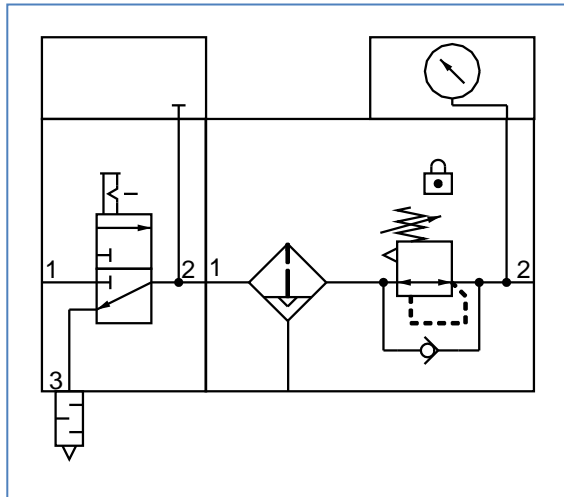

Service unit combination with on-off valve with silencer and filter regulator 0,5-12 bar, 40µm, metal bowl with fully automatic condensate drain.

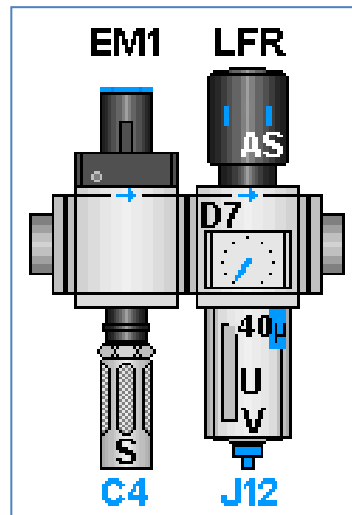

Part number: MS6-3/4" – SE_CS.1482619-B (see page 28)

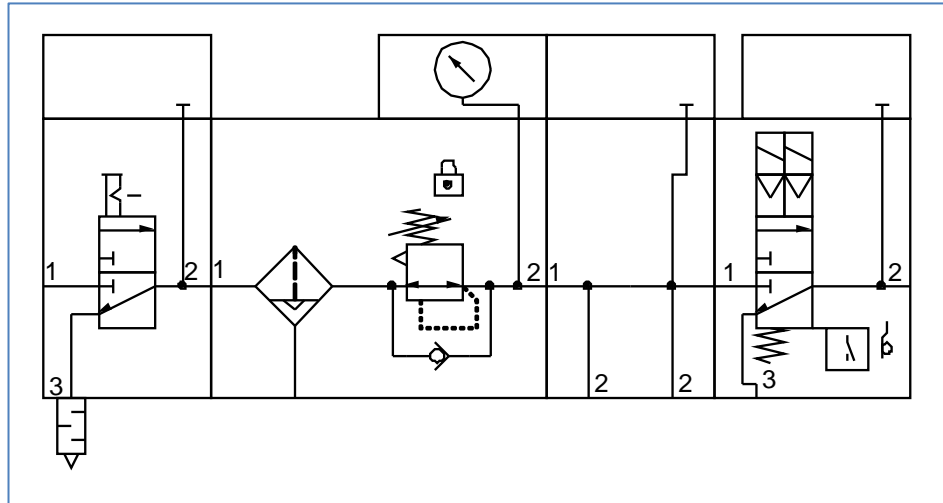

This service unit has performance level PLd.

Service unit combination with on-off valve with silencer, filter regulator 0,5-12 bar, 40µm, metal bowl with fully automatic condensate drain, with soft-start, exhaust valve.

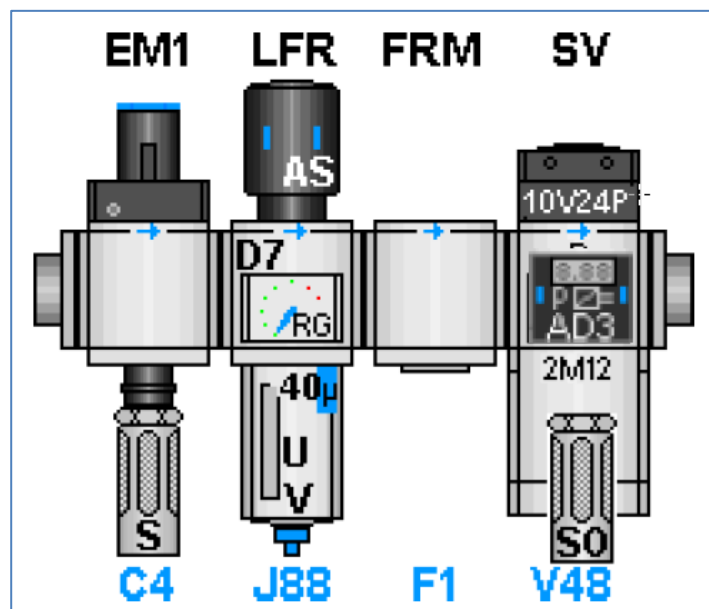

This service unit is also available in performance level PLe with project number SE_CS.1396582-B.

Part number: MS4-3/8" - SE_CS.1396583 (see page 29)

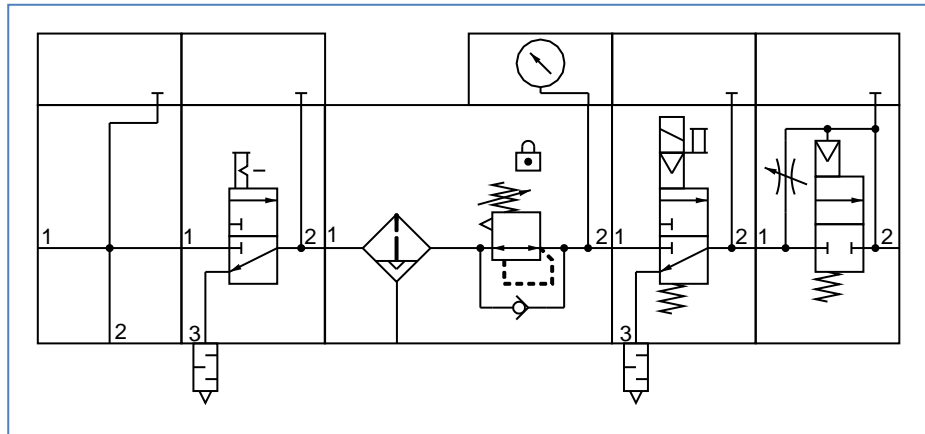

Service unit combination with on-off valve with silencer, filter regulator 0,5-12 bar, 40µm, metal bowl with fully automatic condensate drain, with on-off electrical valve and soft-start valve, pneumatic

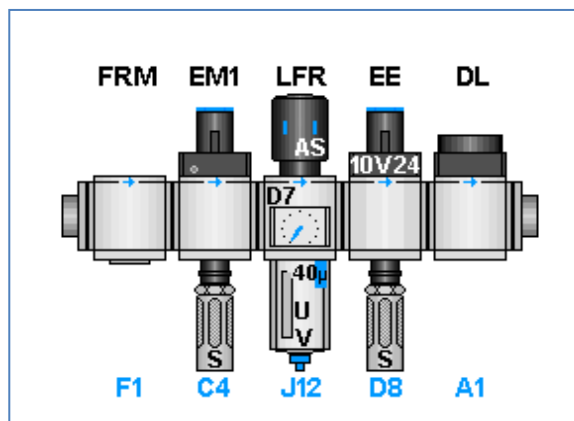

3.3 Tubing technology

Conform to Volvo TPM about colours of tubes.

See also page 23 for hoses.

3.4 Clamping technology

In case of clamping contact Volvo for advice.







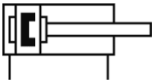

4 Release list overview

4.1 Pneumatic drives

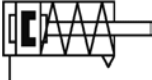

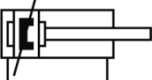







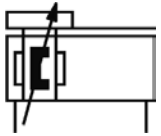

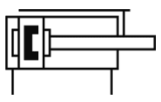
4.1.1 Standard cylinders

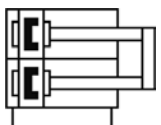
Standard lengths are used primarily, otherwise discuss with Volvo.

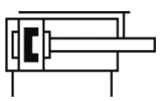
PPS instead of PPV in terms cushions to DSBC, ADN and DSNU cylinders.

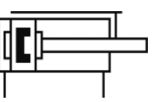

Name	Type	Remarks	Picture	Documentation
Compact cylinder ADN *For Foundry use include R8 vers. ADN-40-50-A-P-A-R8 	ADN-...	Diameter 12, 16, 20, 25, 32, 40, 50, 63, 80, 100, 125 mm Stroke length 1 ... 500 mm Force 51 ... 7363 N Double-acting Position sensing Cushioning fixed/self- adjusting		ADN (engb)
Compact cylinder AEN 	AEN-...	Diameter 12, 16, 20, 25, 32, 40, 50, 63, 80, 100 mm Stroke length 1 ... 25 mm Force 59 ... 4510 N Single-acting, pushing/pulling Position sensing Fixed cushioning		AEN (engb)
Standard cylinder DSBC 	DSBC-...-PPSA-N3 DSBC-...-PPVA-N3 Use Preferred!	Diameter 32, 40, 50, 63, 80, 100 mm Stroke length 1 ... 2800 mm Force 483 ... 4712 N Double-acting Position sensing Adjustable/self-adjusting cushioning - Plus: optional profile with additional sensor slots on three sides		DSBC (engb)
Standard cylinder DSNU, metric 	DSNU-...	Diameter 8, 10, 12, 16, 20, 25 mm Stroke length 1 ... 500 mm Force 19 ... 295 N Double-acting Position sensing Fixed/adjustable/self- adjusting cushioning		DSNU-ISO (engb)

4.1.2 Linear drives and slides



Name	Type	Remarks	Picture	Documentation
Linear drives DGC 	DGC-...	Diameter 8, 12, 18, 25, 32, 40, 50, 63 mm Stroke length 1 to 8500 mm Force 30 to 1870 N Position sensing Various different cushioning options possible Guide options - Basic design - Plain-bearing guide - Recirculating ball bearing guide		DGC (engb)
Mini slide SLS 	SLS-...	Diameter 6, 10, 16 mm Stroke length 5 ... 30 mm Force 17 ... 121 N Position sensing Fixed cushioning Recirculating ball bearing guide.		SLT-SLS-SLF (engb)
Mini slide SLT 	SLT-...	Diameter 6, 10, 16, 20, 25 mm Stroke length 10 ... 200 mm Force 34 ... 590 N Position sensing Fixed cushioning Recirculating ball bearing guide		SLT-SLS-SLF (engb)
Guided drives DFM, metric 	DFM-...	Diameter 12, 16, 20, 25, 32, 40, 50, 63, 80, 100 mm Stroke length 10 ... 400 mm Force 51 ... 4712 N Position sensing Fixed/adjustable cushioning Plain-bearing guide Recirculating ball bearing guide Variants available.		DFM (engb)
Mini slide DGSL, metric 	DGSL-...	Size 4, 6, 8, 10, 12, 16, 20, 25 Diameter 6, 8, 10, 12, 16, 20, 25, 32 mm Stroke length 10 ... 200 mm Force 17 ... 483 N Position sensing Fixed/adjustable cushioning Ball bearing cage guide		DGSL (engb)
Guide units FENG, metric 	FENG-...	For Diameter 32, 40, 50, 63, 80, 100 mm Stroke length 10 ... 500 mm Plain-bearing guide Recirculating ball bearing guide.		FEN-FENG (engb)



4.1.3 Rotary drives





Name	Type	Remarks	Picture	Documentation
Semi-rotary drives DRVS	DRVS-...	Size 6, 8, 12, 16, 25, 32, 40 mm Torque 0.15 ... 20 Nm Swivel angle 90, 180, 270° Position sensing Fixed elastic cushioning elements on both sides		DRVS (engb)
Semi-rotary drives DRRD	DRRD-...	Size 8, 10, 12, 16, 20, 25, 32, 35, 40, 50, 63 mm Torque 0.2 ... 112 Nm Swivel angle 0 ... 180° Position sensing Cushioning: elastic (P), hydraulic shock absorbers Flanged shaft		DRRD (engb)

4.1.4 Pin locating cylinder





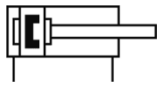



Name	Type	Remarks	Picture	Documentation
Pin locating cylinder STA-SA 	STA-...-P-A-SA 184831 STA-50-25-P-A-SA-23458 185913 STA-50-50-P-A-SA-23551 on request STA-50-75-P-A-SA-1383932A on request STA-80-50-P-A-SA-240204A	Diameter 50 and 80 mm Stroke length 25, 50, 75 mm Permissible impact force on the extended piston rod 170 ... 14600 N Position sensing Fixed cushioning.		STA (de)

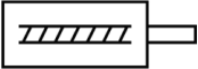

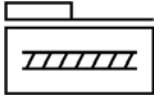
4.1.5 Stopper and clamping cylinders

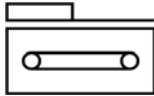
Name	Type	Remarks	Picture	Documentation
Stopper cylinder DFST 	DFST-...	Diameter: 50, 63, 80 mm Stroke length: 30 ... 40 mm Permissible impact force on the advanced piston rod: 3000 ... 6000 N Position sensing Fixed cushioning Toggle lever		DFST (engb)
Stopper cylinders DFSP 	DFSP-...	Diameter 16, 20, 32, 40, 50 mm Stroke length 5 ... 30 mm Permissible impact force on the advanced piston rod 880 ... 6280 N Position sensing Fixed cushioning Variants: trunnion, roller, non-rotating		DFSP (engb)
Clamping units KEC, KPE	KEC-... KPE-...	For round material 4, 6, 8, 10, 12, 16, 20, 25, 32 mm.		KP-KPE-KEC (engb)

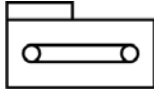
4.2 Electromechanical drives







Name	Type	Remarks	Picture	Documentation
Electric cylinder ESBF 	ESBF-...	Size 32, 40, 50, 63, 80, 100 Stroke length 30 ... 1500 mm Force: 600 ... 17000 N Motor can be mounted using axial or parallel kit Linear drive with ball screw in Clean Design		ESBF (engb)
Spindle axes EGC-BS 	EGC-...-BS	Size 70, 80, 120, 185 mm Stroke length 50 ... 3000 mm Force 300 ... 3000 N		EGC-BS (engb)
Toothed belt axes EGC-TB 	EGC-...-TB	Size 50, 70, 80, 120, 185 mm Stroke length 50 ... 8500 mm Force 50 ... 2500 N		EGC-TB (engb)
Toothed belt axes DGE-ZR 	DGE-...-ZR	Size 8, 12, 18, 25, 40, 63 mm Stroke length 1 ... 5,000 mm Force 15... 1,500 N Speed 1 ... 10 m/s Repetition accuracy 0.08 ... 0.1 mm Position sensing		DGE-ZR (engb)
ERMB rotary modules	ERMB-...	Size 20, 25, 32 mm Max. driving torque 0.7 ... 8.5 Nm Infinite rotation angle		ERMB (engb)

4.3 Motors and controllers



Name	Type	Remarks	Picture	Documentation
Motor unit MTR-DCI	MTR-DCI-...	Size 32, 42, 52, 62 Torque 0.15 ... 11.66 Nm Voltage 24, 48 V DC Nominal current 0.73 ... 6.19 A Suitable motor cable.		MTR-DCI (engb)

4.4 Grippers

4.4.1 Parallel grippers



Name	Type	Remarks	Picture	Documentation
Parallel gripper HGPT 	HGPT-...	Size 16, 20, 25, 35, 40, 50, 63, 80 mm Stroke length 3 ... 20 mm per gripper jaw Force 53 ... 3150 N per gripper jaw Position sensing Sealing air connection.		HGPT-B (engb)
Parallel gripper HGPL 	HGPL-...	Size 14, 25, 40, 63 mm Stroke length 40 ... 150 mm per gripper jaw Force 79 ... 1371 N per gripper jaw Position sensing.		HGPL (engb)
Parallel gripper DHPS 	DHPS-...	Size 6, 10, 16, 20, 25, 35 mm Stroke length 2 ... 12.5 mm per gripper jaw Force: 13.5 ... 483 N per gripper jaw Position sensing Can be used as either a double-acting or single-acting gripper.		DHPS (engb)

4.4.2 Radial grippers

Name	Type	Remarks	Picture	Documentation
Radial gripper DHRS 	DHRS-...	Size 10, 16, 25, 32, 40 mm Opening angle 180° Total gripping torque 15 ... 725 Nm Position sensing With or without gripping force backup		DHRS (engb)

4.5 Valves

4.5.1 Standard valves

Name	Type	Remarks	Picture	Documentation
Standard valves VSVA with round plugs M12x1	VSVA-B-...-1R5L	Flow rate 400 ... 1400 l/min Voltage 24 V DC Sub-base valve Solenoid actuated, piloted Sub-bases.		ISO15407VSVA (engb) ISO5599VSVA (engb)
Valves VUVG, for individual connection	VUVG-...	Connection M3, M5, M7, G1/8 Push-in connector 3, 4, 6, 8 mm Flow rate 90 ... 780 l/min Voltage 5, 12, 24 V DC In-line valves, semi in-line valves, sub-base valves - Solenoid actuated, piloted - Pneumatic and mechanical spring return from the VG series		VTUG-G (engb)
Valves VMPPA	VMPPA-...	Port M7 Flow rate 230 ... 360 l/min Sub-base valve - Solenoid actuated - Signal status display with LED - Integrated current reduction Manifold blocks Manifold sub-bases.		TYP32 (engb) VMPPA1 (engb)

4.5.2 Proportional valves

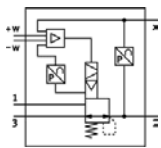

Name	Type	Remarks	Picture	Documentation
Proportional-pressure regulators VPPM	VPPM-...	Connection: G1/8, G1/4 Flow rate: 380 ... 2750 l/min. Pressure regulators 3 selectable presets (fast, universal, precise) Optionally available display.		VPPM-G (engb)



4.5.3 Flow control valves

Name	Type	Remarks	Picture	Documentation
One-way flow control valves 	VFOF-...	Flow rate: 0 ... 650 l/min. Shut-off valve		VFOF (engb)
Non-return valves, piloted HGL 	HGL-... Use only with manual override HAB!	Port M5, G1/8, G1/4, G3/8, G1/2 Flow rate 130 ... 1600 l/min Shut-off valve - Pneumatic piloted non-return valve		HGL (engb)
Manual override tools	HAB-...	Hand lever Manual overrides.		HGL (engb)
One-Way flow control valves (exhaust) GRxA, GRxZ 	GRLA-...	Connection M3, M5, G 1/8, G 1/4, G 3/8, G 1/2 Plug connector 3, 4, 6, 8, 10, 12 mm Flow rate 0 ... 1,400 l/min Non-return and flow control valve.		GR-VF (engb) GRX-VFO (engb)
In-line installation GR 	GR-... GRA-...	Connection M3, M5, G1/8, G1/4, G3/8, G1/2, G3/4 Push-in connector 3, 4, 6, 8 mm Flow 0 ... 3 300 l/min Non-return and flow control valve.		GRX-VFOI (engb)

4.6 Valve terminals

Name	Type	Remarks	Picture	Documentation
MPA-S with CPX terminal type 32	MPA-...	Controlled via fieldbus or control block Max. 64 valve positions/max. 128 solenoid coils - Digital inputs/outputs - Analogue inputs/outputs - Parameterisation of inputs and outputs - Integrated convenient diagnostics system - Preventive maintenance concepts.		TYP32-G (engb)
CPX electrical terminal type 50	CPX-...	Operating mode - Stand-alone - With valve terminal MPA Input/output modules Digital Analogue.		CPX (engb)

4.7 Vacuum technology

Name	Order code	Remarks	Picture	Documentation
OVEM vacuum generator, metric	OVEM-...	Nominal diameter 0.45 ... 2.0 mm Port -Plug connector QS6, QS8 Solenoid valve vacuum IN/OUT Solenoid valve for ejector pulse Integrated vacuum switch.		OVEM (engb)
Vacuum generators VN, pneumatic	VN-...	Nominal size 0.45 to 3 mm Connection -Plug connector QS4, QS6, QS8, QS10, QS12 -Thread M5, G1/8, G1/4, G3/8 -Push-in sleeve 4.6 mm Standard -Vacuum port 90° to supply port Inline -Vacuum port in line with supply port Ejector pulse valve, pneumatic.		VN (engb)

4.8 Sensors





4.8.1 Pressure sensors

Name	Type	Remarks	Picture	Documentation
Pressure sensors SPAU	SPAU-...	Pressure measuring range -1 to 16 bar Voltage 20 ...30 V DC Switching output 2x PNP or 2x NPN selectable Electrical output 0.1 ... 10 V, 1 ... 5 V, 4 ... 20 mA Pneumatic connection G1/8, R1/8, R1/4, NPT1/8, M5, M7, push-in connector 4 mm, 6 mm, 5/32" Pressure switch Vacuum switch		SPAU (engb)
Pressure sensors SDE3 	SDE3-... With analogue outputs preferred!	Pressure sensor Vacuum sensor Differential pressure measurement Illuminated LCD with optimised display		SDE3 (engb)

4.8.2 Air gap sensor

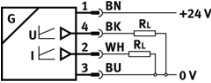
Name	Type	Remarks	Picture	Documentation
Air gap sensors SOPA	SOPA-...	Sensing range 20 ... 200 µm Pressure 4 ... 7 bar Switching outputs PNP or NPN Integrated air jet function Multi-coloured LCD display Filtered compressed air, lubricated or unlubricated H-rail, wall mounting, through-hole		SOPA (engb)

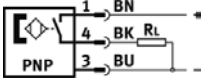
4.8.3 Proximity sensors





Name	Type	Remarks	Picture	Documentation
Position transmitter SMAT 	SMAT-...	0 - 10 V, 0 - 20 mA Path measurement range 48 ... 52 mm Electric connection, 4-pin, M8x1 plug Design for T-slot		SMAT-8E (engb) SMAT-8M (engb)
Proximity sensor SMT-8M-A 	SMT-8M-A-...	Voltage 5...30 V DC Cable length 0.1 ... 30 m Plug connection M8, M12 Electrical Contactless PNP Short design		SMX8 (engb)

4.9 Compressed air preparation







Name	Type	Remarks	Picture	Documentation
Service units MS4	MS4-...	Port G1/8, G1/4, G3/8 Flow rate 550 ... 1500 l/min		MSB-FRC (engb) MS-COMBINATION (engb) MS-CONFIG-COMBINATION (engb) MS-LFR (engb) MS-FILTERS (engb) MS-REGULATORS (engb) MS-START-UP-EXHAUST-VALVES (engb) MS-FRM (engb)
Service units MS6	MS6-...	Port G1/4, G3/8, G1/2, G3/4 Flow rate 1900 ... 5100 l/min		MSB-FRC (engb) MS-COMBINATION (engb) MS-CONFIG-COMBINATION (engb) MS-LFR (engb) MS-FILTERS (engb) MS-REGULATORS (engb) MS-START-UP-EXHAUST-VALVES (engb) MS-FRM (engb) MS-SV (engb)
Service units MS9	MS9-...	Port G1/2, G3/4, G1, G1 1/4, G1 1/2 Flow rate 5100 ... 14000 l/min.		MS-CONFIG-COMBINATION (engb) MS-LFR (engb) MS-FILTERS (engb) MS-REGULATORS (engb) MS-START-UP-EXHAUST-VALVES (engb) MS-FRM (engb) MS-SV (engb)
Flow sensors SFAM	SFAM-... With analogue outputs preferred! Not allowed to take air from the FRM before the SFAM.	Flow measuring ranges - 10 ... 1000 l/min - 30 ... 3000 l/min - 50 ... 5000 l/min Switching output - 2x PNP Analogue output - 0 .. 10V - 4 ... 20mA		SFAM (engb)
Pressure regulators	MS...-LR-...	Port G1/8, G1/4, G3/8, G1/2, G3/4, G1, G1 1/4, G1 1/2 Flow rate 1000 ... 26500 l/min		MS-LR (engb)
Precision pressure regulators	MS6-LRP-...	Port G1/4, G3/8, G1/2, G3/4 Flow rate 800 ... 5000 l/min		MS-LRP (engb)
Pressure gauges MAE	for MS4: for MS6	701608 MAE-MS4/6-10-BAR-RG 701609 MAE-MS4/6-16-BAR-RG 701611 MAE-MS6-10-BAR-RG 701612 MAE-MS6-16-BAR-RG		

[Samples of service units see page 25 to 27.](#)

4.10 Pneumatic fittings system

Name	Type	Remarks	Picture	Documentation
Plastic tubing PEN Up to 60 degrees	PEN-... More extensive resistance to conventional cleaning agents and lubricants	Outside diameter 4 ... 16 mm Temperature-dependent operating pressure -0.95 ... 10 bar Ambient temperature -30 ... 60 °C Operating medium - Compressed air - Vacuum		OD-TUBING (engb)
Plastic tubing PUN	PUN-...	Outside diameter: 3 ... 16 mm Temperature-dependent operating pressure: -0.95 ... 10 bar Ambient temperature: -35 ... 60° C Operating medium - Compressed air - Vacuum		OD-TUBING (engb)
Plastic tubing PAN	PAN-...	Outside diameter: 4 ... 16 mm Temperature-dependent operating pressure: -0.95 ... 19 bar Ambient temperature: -30 ... 80° C Operating medium - Compressed air - Vacuum		OD-TUBING (engb)
Quick Star push-in fittings, standard series QS	QS-...	Connection G 1/8, G 1/4, G 1/2, G 3/8 diameter 4, 6, 8, 10, 12, 16 mm screw connection - G thread with sealing ring suitable for a vacuum push-in fittings push-in bulkhead connectors push-in fittings with push-in sleeves blanking plugs multiple distributor push-in bulkhead fittings.		QS (engb)
Quick Star NPQM, metal, standard	NPQM-...	Connection M5, M7, G1/8, G1/4, G3/8, G1/2 Push-in connector 4, 6, 8, 10, 12, 14 mm Push-in sleeve 4, 6, 8, 10, 12 mm Threaded connection - G thread with sealing ring Push-in fittings Push-in connectors Push-in connectors with push-in sleeves Fully metal design		NPQM (engb)

4.11 Other pneumatic equipment

Name	Type	Remarks	Picture	Documentation
Air Reservoirs CRVZS 	CRVZS-...	Volume: 0.1 ... 20 l Material: High-alloy stainless steel Equivalent to AD 2000.		AIR-RESERVOIRS (engb)
Silencers U 	U-...	Port thread M3, M5, G1/2, G1/4, G1/8, G3/8, G3/4, G1 Noise level 65 ... 84 dB(A)		SILENCERS (engb)
Silencers UC 	UC-...	Port thread M5, M7, G1/8, G1/4 Noise level 58 ... 68 dB(A)		SILENCERS (engb)
Tube holder NPAW	NPAW-...	Mounting attachment for guiding cables and hoses		CLIP-STRAPS (engb)

5 Service Units - Details

5.1 Service Unit 1 – G1/2"

Size: G 1/2"

Order number: Systemtechnic Project Number SE_CS.1396581

Configuration:

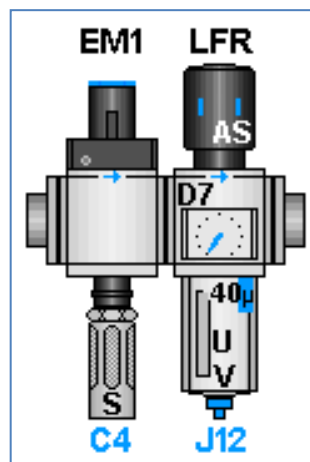

Pneumatic diagram:

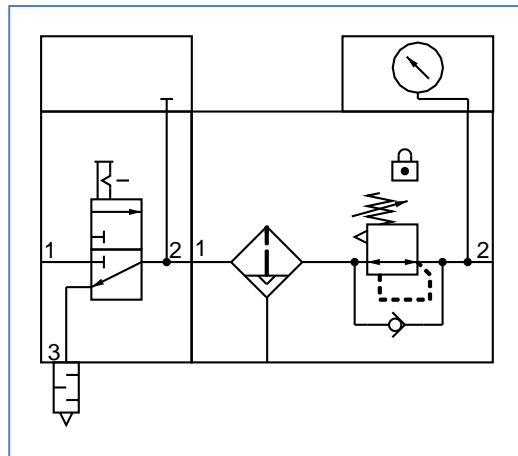

Parts List:

Pos.	Quantity	Description	Type	Part number
1	1	Service unit combination	MSB6-AGD:C4:J12-WP	531030
3	1	Pressure gauges set	MAE-MS6-10-BAR-RG	701611
		Service unit consists of :		
		On-Off valve	MS6-EM1-1/2-S	541268
		Filter Regulator	MS6-LFR-1/2-D7-EUV-AS	529194

5.2 Service Unit 2 – G3/4”

Size: G 3/4”

Order number: Systemtechnic Project Number SE_CS.1482619-B

Configuration:

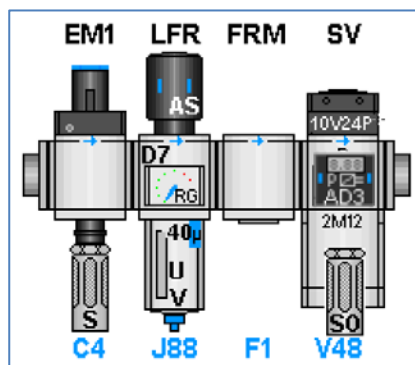

This service unit has performance level PLd.

Pneumatic diagram:

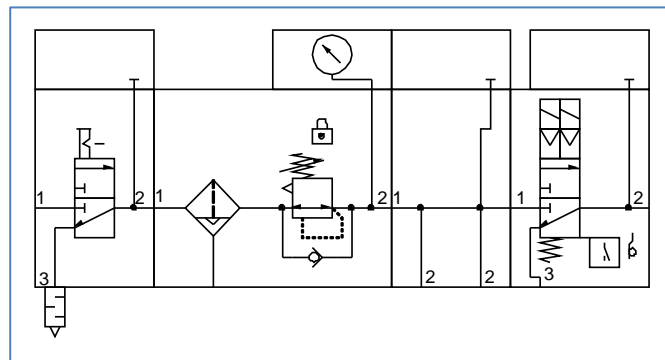

Parts List:

Pos.	Quantity	Description	Type	Part number
1	1	Service unit combination	MSB6-AGE:C4:J12:F1-WP	531030
2	1	Soft start and exhaust valve	MS6-SV-1/2-D-10V24P-2M12-AD3	548713
3	1	Silencer	UOS-1-LF	1901207
4	1	Adapter	MS6-MV	532799
5	4	Blanking plug	B-1/2	3571
6	1	Pressure gauges set	MAE-MS6-10-BAR-RG	701611
		Service unit consists of :		
		On-Off valve	MS6-EM1-1/2-S	541268
		Filter Regulator	MS6-LFR-1/2-D7-EUV-AS	529194
		Branching module	MS6-FRM-1/2	529853

This service unit is also available in performance level PLe with project number SE_CS.1396582-B.

5.3 Service Unit 3 – G3/8”

Size: G 3/8”

Order number: Systemtechnic Project Number SE_CS.1396583

Configuration:

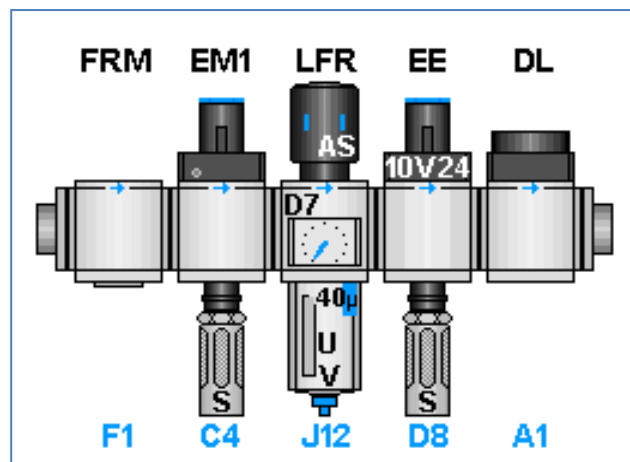

Pneumatic diagram:

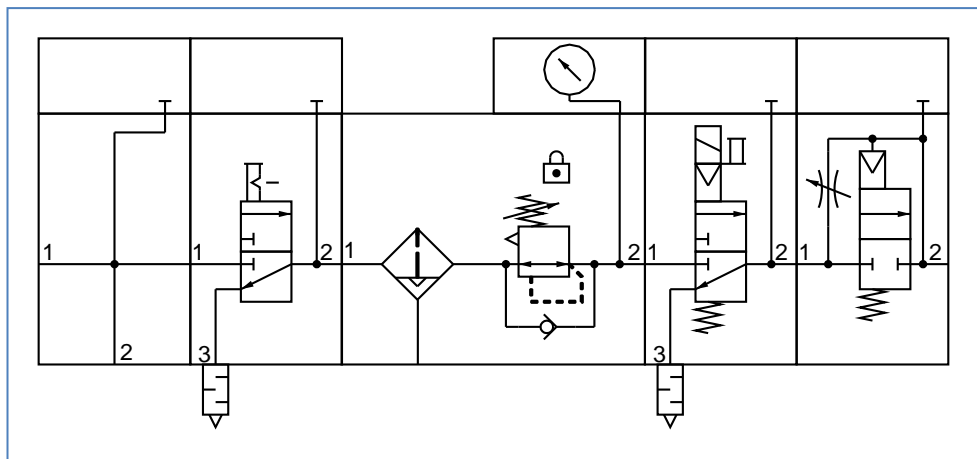

Parts List:

Pos.	Quantity	Description	Type	Part number
1	1	Service unit combination	MSB4-AGC:F1:C4:J12:D8:A1-WP	531029
	1	Pressure gauges set	MAE-MS4/6-10-BAR-RG	701608
3	1	Plug socket with cable	KMEB-1-24-5-LED	151689
4	1	Blanking plug	B-1/4	3569
		Service unit consists of :		
		Branching module	MS4-FRM-1/4	529555
		On-Off valve	MS4-EM1-1/4-S	541259
		Filter Regulator	MS4-LFR-1/4-D7-EUV-AS	535722
		On-Off valve	MS4-EE-1/4-10V24-S	542598
		Soft-start valve	MS4-DL-1/4	529531



6 Alphabetically list of approved products

ADN-.....	12	MS4-... ..	22
AEN-... ..	12	MS6-... ..	22
CPX-.....	19	MS6-LRP-... ..	22
CRVZS-... ..	24	MS9-... ..	22
DFM-.....	13	MTR-DCI-.....	16
DFSP-... ..	15	NPAW-.....	24
DFST-.....	15	NPQM-.....	23
DGC-.....	13	OVEM-... ..	20
DGE-...-ZR.....	16	PAN-... ..	23
DGSL-.....	13	PEN-... ..	23
DHPS-.....	17	PUN-... ..	23
DHRS-.....	17	QS-.....	23
DRRD-.....	14	SDE3-... ..	20
DRVS-... ..	14	SE_CS.1396581	25
DSBC-...-PPSA-N3.....	12	SE_CS.1396583	27
DSBC-...-PPVA-N3.....	12	SE_CS.1482619-B.....	26
DSNU-... ..	12	SFAM-... ..	22
EGC-...-BS.....	16	SLS-... ..	13
EGC-...-TB.....	16	SLT-.....	13
ERMB-... ..	16	SMAT-.....	21
ESBF-... ..	16	SMT-8M-A-... ..	21
FENG-.....	13	SOPA-... ..	21
GR-... ..	19	SPAU-... ..	20
GRA-... ..	19	STA-...-P-A-SA	14
GRLA-... ..	19	STA-50-25-P-A-SA-23458.....	14
HAB-... ..	19	STA-50-50-P-A-SA-23551.....	14
HGL-... ..	19	STA-50-75-P-A-SA-1383932A.....	14
HGPL-... ..	17	STA-80-50-P-A-SA-240204A	14
HGPT-... ..	17	U-... ..	24
KEC-... ..	15	UC-... ..	24
KPE-... ..	15	VFOF-.....	19
MAE-MS4/6-10-BAR-RG	22	VMPA-... ..	18
MAE-MS4/6-16-BAR-RG	22	VN-... ..	20
MAE-MS6-10-BAR-RG	22	VPPM-... ..	18
MAE-MS6-16-BAR-RG	22	VSVA-B-...-1R5L	18
MPA-... ..	19	VUVG-... ..	18
MS-...-LR-.....	22		

7 Drawings

Hub Bestellnr.	Bestellbez.	SA-Nr.	L1	L2	L3
25	184 831 STA-50-25-P-A-SA	SA-23458	70.5	160.5	62.5
50	185 913 STA-50-50-P-A-SA	SA-23551	95.5	185.5	87.5

SA-23458

Index	Anderungs-Nr.	Arzt	Tag	Name
b	155443	1	27.11.06	CHR
Typ: STA-50-25-P-A-SA				
FESTO				
TA-Grp			Tag	Name
gez.			26.11.97	WCH
gezeichnet			26.11.97	HAL
Freigegeben			30.11.04	SBN
Herstell-Nr. 932629				
Dok.-Art: MAS				
Teil-Nr.: 932629				

WEITERE DATEN SIEHE KATALOGBLATT STA-50...

Copyright by Festo AG & Co. KG
All rights reserved
Referred to protection notice ISO 15016