

CMMD-AS-C8-3A

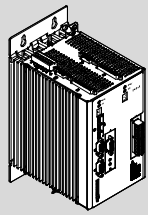

FESTO

Festo AG & Co. KG
Postfach
73726 Esslingen
Germany
+49 711 347-0
www.festo.com

Brief description

8034544
1404a
[8034439]

Original: de

Motorcontroller CMMD-AS-C8-3A **English**
Translation of the original instructions

i You can find the complete documentation for the motor controller CMMD-AS in PDF format on the CD-ROM accompanying the motor controller or via the support portal → www.festo.com/sp.

User documentation on the motor controller CMMD-AS

Description, mounting and installation, GDCP-CMMD-AS-HW-...	Mounting, installation, pin allocations and error messages
Description of the safety function STO, GDCP-CMMD-AS-S1-...	Functional safety engineering for the motor controller with the STO safety function
Description, functions and commissioning, GDCP-CMMS/D-FW-...	Functional description and commissioning with FCT Control interfaces and device profiles
Description of device profile FHPP, GDCP-CMMS/D-C-HP-...	Description of the bus interfaces, control and parameterisation of the motor controller via the device profile FHPP from Festo
Description of device profile CiA 402, GDCP-CMMS/D-C-CO-...	Description of CAN interface of the motor controller, control and parameterisation via device profile CiA 402.
Help on the CMMD-AS FCT plug-in	User interface and functions of the CMMS-AS plug-in for the Festo Configuration Tool → www.festo.com/sp

1 Safety and requirements for product use

1.1 Safety

Warning
Danger of electric shock



Touching live parts causes severe injuries and can lead to death:
– when the module or cover plate is not mounted on the card slot [EXT]
– when cables are not mounted to the plugs [X6] and [X9]
– during disconnection of connecting cables when powered.

The product must be installed in a control cabinet. The product may only be used if all safeguarding has been installed and is operational.

Before touching live parts during maintenance, repair and cleaning work and when there have been long service interruptions:

1. Switch off power to the electrical equipment via the mains switch and secure it against being switched on again.
2. After switch-off, wait at least 5 minutes discharge time and check that power is turned off before accessing the motor controller.

Caution
Danger of burns from hot surfaces



Dependent on the load, housing temperatures > 80 °C are possible in operation.

- Protect hot surfaces from contact in operation.
- Touch them only in a switched-off, cooled-off status.

Note
Danger from unexpected movement of the motor or axis

- Make sure that the movement does not endanger anyone.
- Perform a risk assessment in accordance with the EC Machinery Directive.
- Based on this risk assessment, design the safety system for the entire machine, taking into account all integrated components.

Intended use

The motor controller CMMD-AS is a digital positioning controller for servo motors for

- supply and control of two motors
- regulation of torque (current), speed and position.

The motor controller supports the following **safety function**:

- “Safe torque off” (STO)
Category 3 / PL d in accordance with EN ISO 13849-1.

Use exclusively:

- in an excellent technical status
- in original status, without unauthorised modifications
- within the limits of the product defined through the technical data
- **for the safety function** within the specified service life of the switching elements → Section 9
- in an industrial environment
- as an installed device in a control cabinet.

Issue status of the specified standards

EN 60204-1:2006/A1:2009-02	EN ISO 13849-1:2008-06
EN 61800-5-1:2007-09	

Foreseeable misuse of the safety function

- use outside or in a non-industrial area (residential area),
- use in applications where switching off can result in hazardous movements or conditions.

→ Note

- The STO function is insufficient as the sole safety function for drives subject to permanent torque or force (e.g. suspended loads).
- Bypassing of safety equipment is impermissible.
- Repairs to the motor controller are impermissible!

i The STO (Safe Torque Off) function does not provide protection against electric shock, only against dangerous movements!

In applications with extremely high requirement rates, the service life of the switching elements must be taken into account in the design (replacement interval for the motor controller) → Section 9.

Attainable safety level in accordance with EN ISO 13849-1

The motor controller can be used in applications up to Cat. 3 / PL d in accordance with EN ISO 13849-1. The overall achievable safety level depends on the other components used to achieve the safety function.

1.2 Requirements for product use

For correct and safe use of the product:

- Comply with the connection and ambient conditions of the product and all connected components specified in the technical data. Compliance with the limit values and load limits permits operation of the product in compliance with the relevant safety regulations.
- Observe the instructions and warnings in the documentation.
- **For the safety function:** If the safety function is demanded, protection against automatic restart corresponding to the required category must be furnished, e.g. via an external safety switching device.

Qualification of the specialized personnel (requirements for the personnel)

The product may only be placed in operation by a qualified electrotechnician who is familiar with:

- the installation and operation of electrical control systems,
- the applicable regulations for operating safety-engineered systems,
- the applicable regulations for accident protection and occupational safety, and
- the documentation for the product.

Diagnostic coverage (DC) for the safety function

Diagnostic coverage depends on the interconnection of the motor controller with the control loop system as well as the implemented diagnostics measures.

If a potentially dangerous malfunction is recognised during the diagnostics, appropriate measures must be taken to maintain the safety level.

→ Note

Check whether a fault exclusion of cross circuits in the input circuit and connection wiring is possible in your application.
If necessary, use a safety switching device with cross-circuit detection.

Range of application and certifications

The motor controller with integrated STO safety function is a safety-related part of the control systems. The motor controller carries the CE marking.

i For certificates and the declaration of conformity for this product → www.festo.com/sp.

2 Product overview

Connections with the index ".1" are assigned to axis 1. Connections with the index ".2" are assigned to axis 2. Shared connections do not have an index. The notation ".1/2" refers to both connections (e.g. [X1.1/2]).

2.1 Device view

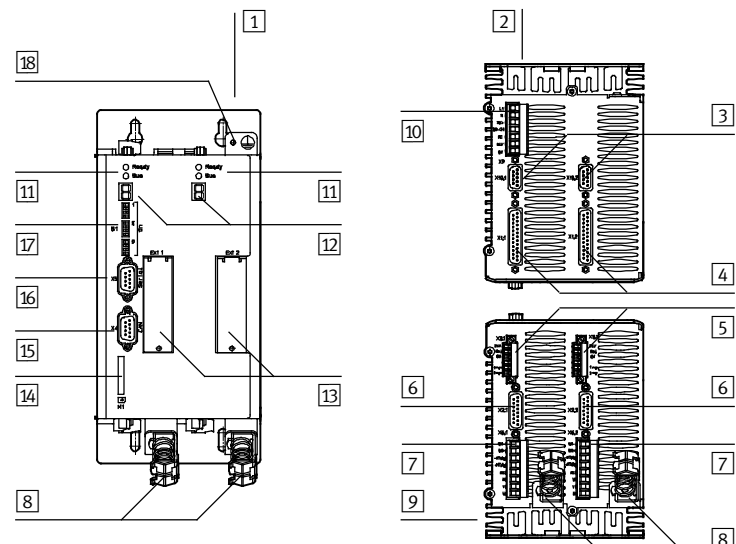

- | | | | |
|----|----------------------------|----|--|
| 1 | Front view | 11 | LED status display |
| 2 | View on top | 12 | 7-segments display |
| 3 | [X10.1/2] Master/slave | 13 | [EXT1/2]: Slot for CAMC... |
| 4 | [X1.1/2] I/O interface | 14 | [M1]: SD memory card |
| 5 | [X3.1/2] STO interface | 15 | [X4.1/2]: CAN bus |
| 6 | [X2.1/2] Encoder | 16 | [X5]: RS232/RS485 |
| 7 | [X6.1/2] Motor | 17 | [S1]: DIP switch |
| 8 | Shield connection terminal | 18 | Earthing screw (central PE connection) |
| 9 | View underneath | | |
| 10 | [X9] Power supply | | |

Fig. 1 Motor controller CMMD-AS

2.2 Display and control elements

7-segments display¹⁾

	Rotating outside segments	Speed mode (speed adjustment): Display changes corresponding to rotor position and speed.
	Middle segment	Controller enable active (motor is energised).
	I	Force mode (current control).
	P x x x	Positioning mode, record number x x x
	P H x	Homing phase x
	H	Two-channel safety function requested (DIN4 [X1.21] and Rel [X3.2]).
	Point	Start program (Bootloader) active.
	Flashing point	– Firmware file (memory card) is being read. – Display of errors through the start program.
	E x x y	Error (E = error) Number: Two-position main index (x x), single-position subindex (y) Example: E 0 1 0 → Section 7.
	- x x y -	Warning Number: Two-position main index (x x), single-position subindex (y). Example: - 1 7 0 - → Section 7.

1) Several characters are displayed one after the other.

LED indicator

Ready	Green	Operating status/controller enable
	Flashing green	Parameter file (memory card) is being read/written
CAN	Yellow	Status display: CAN bus active

DIP switch

S1.1 ... 7	CAN bus address or MAC-ID
S1.8	Automatic loading of new firmware from memory card
S1.9 ... 10	Setting the CAN-bus transmission rate
S1.11	Activation of the CAN-bus interface
S1.12	Terminating resistor for CAN-bus

3 Mechanical installation

3.1 Mounting

Observe the information on the installation dimensions and free spaces in the → Mounting and installation description GDPC-CMMD-AS-HW-...

For vertical mounting onto a control cabinet mounting plate:

- Mount the accompanying mounting bracket to the motor controller.
- Use the motor controller exclusively in a control cabinet:
 - The mounting position is vertical with the power supply lines [X9] on top
 - Mounting to the mounting brackets with M5 screws.

4 Electrical installation



Caution
Danger from unexpected movement

Faulty pre-assembled lines may destroy the electronics and trigger unexpected movements of the motor.

- When wiring the system, use only the supplied plug connectors and preferably the cables listed in the catalogue as accessories.
 - www.festo.com/catalogue
- Lay all flexible lines so that they are free of kinks and free of mechanical stress; if necessary in an energy chain.



Note

ESD (electrostatic discharge) can cause damage to the device or other system parts at plug connectors that are not used.

- Before installation: Earth the system parts and use appropriate ESD equipment (e.g. shoes, earthing straps etc.).
- After installation: Seal unassigned D-sub plug connectors with protective caps (available at authorized dealers).
- Observe the handling specifications for electrostatically sensitive devices.



Warning
Danger of electric shock

Motor controllers are devices with increased leakage current (> 10 mA). If wiring is incorrect or the device is defective, high voltage can occur on the housing, which can result in serious injury or even death if the housing is touched.

- Before commissioning, also for brief measuring and test purposes, connect the PE protective conductor:
 - to the earthing screw of the controller housing,
 - to pin PE [X9.5], power supply. The cross section of the protective conductor at PE [X9.5] must correspond at least to the cross section of the external conductor L [X9.1].
- Observe the regulations of EN 60204-1.



Observe the information on safe and EMC-suitable installation and on protective earthing in the mounting and installation description, GDPC-CMMD-AS-HW-....

4.1 I/O interface [X1.1/2]

Pin	Value	Assignment in 0 mode – positioning
1	SGND	0 V Screening for analogue signals
2	DIN12/AINO	–/max. 30 V Mode bit 0 /setpoint input 0 ²⁾
3	DIN10	– Record selection bit 4 (high active)
4	+VREF	+10 V ± 4 % Reference output for setpoint value potentiometer
5	–	–
6	GND24	– Reference potential for digital I/O modules
7	DIN1	– Record selection bit 1 (high active)
8	DIN3	– Record selection bit 3 (high active)
9	DIN5	– Controller enable (high active)
10	DIN7	– Limit switch 1
11	DIN9	– Mode bit 1
12	DOUT1	24 V 100 mA Motion complete (high active) ¹⁾
13	DOUT3	24 V 100 mA Common error (low active) ¹⁾
14	AGND	0 V Reference potential for analogue signals
15	DIN13/#AINO	–/Ri = 20 kΩ Stop (low active)/reference potential AINO ²⁾
16	DIN11	– Record selection bit 5 (high active) ²⁾
17	AMONO	0 ... 10 V ± 4 % Output: analogue monitor 0
18	+ 24 V DC	24 V 100 mA Output: 24 V DC, looped through from [X9.6]
19	DINO	– Record selection bit 0 (high active)
20	DIN2	– Record selection bit 2 (high active)
21	DIN4	– Output stage enable (high active)
22	DIN6	– Limit switch 0
23	DIN8	– Start for the positioning procedure (high active)
24	DOUT0	24 V 100 mA Output: Controller ready for operation (high active)
25	DOUT2	24 V 100 mA Start acknowledged (low active) ¹⁾

1) Default setting, configurable in the Festo Configuration Tool (FCT).

2) Pin allocation with control via analogue input

4.2 Encoder [X2.1/2]

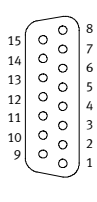
[X2.1/2]	Pin	Value	Description	
	1	M _{T+}	+3.3 V / 3 mA	Temperature sensor, motor temperature.
	2	-U _{SENS}	0 V	Connected internally with pin 3
	3	GND	0 V	Reference potential US and M _{T+}
	5	#DATA	U _{SS} = 5 V	RS485 data transmission line (differential)
	6	#SCLK	U _{SS} = 5 V	Cycle output RS485 EnDat interface
	9	+U _{SENS}	5 V (-0 % ... +5 %)	Connected internally with pin 10
	10	US	5 V (-0 % ... +5 %)	Operating voltage for EnDat encoder
	12	DATA	U _{SS} = 5 V	RS485 data transmission line (differential)
	13	SCLK	U _{SS} = 5 V	Cycle output RS485 EnDat interface

4.3 STO interface [X3.1/3]

Interface [X3] (circuitry without use of the STO safety function)

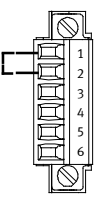
[X3.1/2]	Pin	Value	Description	
	1	24 V	24 V DC	Voltage output (24 V DC logic supply carried out as auxiliary voltage)
	2	REL	0 V/24 V DC	Setting and resetting the relay for interrupting the driver supply
	3	0 V	0 V (GND 24 V DC)	Reference potential for PLC (24 V DC)
	4	-	-	-
	5	NC1	Max. 25 V AC, 30 V DC, 2 A	Potential-free feedback contact for driver supply, N/C contact
	6	NC2		

Circuitry without use of the STO safety function

If you do **not** need the integrated safety function STO in your application, to operate the motor controller you must bridge Pin 1 and Pin 2 at the X3.1/2 interface (delivery status).

This deactivates the integrated safety function!

With this circuitry, safety in the application must be ensured through other appropriate measures.

Use of the STO safety function

For intended use of the safety function STO – “Safe Torque Off”, observe the information in the STO description → GDPC-CMMD-AS-S1-...

Use the “Safe torque off” function (STO) whenever you have to reliably disconnect the energy supply to the motor in your application. To ensure the function STO “Safe Torque Off”, the control ports DIN4 [X1.1/2] Pin 21 and Rel [X3.1/2] Pin 2 must be connected in two channels through parallel wiring. This interface can be part of an emergency stop circuit or a safety door arrangement, for example.

Recommendation for first commissioning without safety engineering:

Minimum circuitry with emergency stop switching device and two-channel switch-off via the control ports REL [X3.1/2] Pin 2 and DIN4 [X1.1/2] Pin 21.

Note
Loss of the safety function.

Lack of the safety function can result in serious, irreversible injuries, e.g. due to uncontrolled movements of the connected actuator technology.

- The STO function request must always run in two channels over [X3.1/2] Pin 2 and [X1.1/2] Pin 21 (end stage enable).
- If uncontrolled coasting can result in a hazard or damage, additional measures are required.
- A clamping unit is actuated by the non-safety-relevant firmware of the motor controller CMMD-AS.
- Make sure that no jumpers or the like can be inserted parallel to the safety wiring, e.g. through the use of the maximum wire cross section of 1.5 mm² or suitable wire end sleeves with insulating collars.
- Use twin wire end sleeves for looping through lines between adjacent devices.
- Comply with the specified environmental and connection conditions, in particular the input voltage tolerances.
- Place the motor controller in operation only if all safeguarding, including the safety function, has been installed and checked.
- The safety function must be checked and, prior to the intended use, a corresponding validation must be carried out.

4.4 CAN [X4]

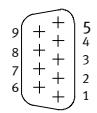
[X4]	Pin	Value	Description	
	2	CANL	5 V, Ri = 60 Ω	CAN low, signal line
	3	GND	-	CAN GND, not galvanically isolated
	5	Screening	-	Connection for the cable screening
	6	GND	-	CAN GND, not galvanically isolated
	7	CANH	5 V, Ri = 60 Ω	CAN high signal line

4.5 Serial interface RS232/RS485 [X5]

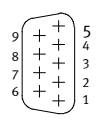
[X5] RS232	Pin ¹⁾	Value	Description	
	2	RS232_RxD	10 V, Ri > 2 kΩ	Receive signal
	3	RS232_TxD	10 V, Ra < 2 kΩ	Transmission signal
	4	RS485_A		Positive transmission and reception signal
	5	GND	0 V	Reference potential 0 V DC
	9	RS485_B		Negative transmission and reception signal

1) Connect only the pins for RS232 or RS485, dependent on the interface used!

4.6 Motor [X6.1/2]

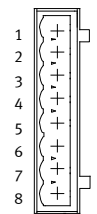
[X6.1/2]	Pin ¹⁾	Value	Description	
	1	BR-	0 V	For motors EMMS-AS-...- TSB/TMB: holding brake (motor)
	2	BR+	24 V	
	3	M _{T-}	0 V	Temperature sensor (N/C contact, N/O contact, PTC or KTY)
	4	M _{T+}	+ 3.3 V, 5 mA	
	5	PE	-	PE connection of the motor cable
	6	W	3 x 0 ... input voltage;	Connection of the three motor phases (→ Mounting and installation description)
	7	V	Axis 1: max. 10 A _{eff} ²⁾	
	8	U	Axis 2: max. 10 A _{eff} ²⁾	

- 1) In the motor and connecting cable, reliable separation of the motor temperature sensor from the motor circuit must be ensured.
- 2) Total nominal current for both axes ≤ 8 A

If third-party cables are used: Place the complete screening of the motor-side cable flat on the plug connector or motor housing. Length ≤ 40 mm.

- Place the complete screening of the motor cable at the screening connection terminal of the related motor controller so that the leaked current can flow back into the controller that causes it
- Do not use the complete screening as strain relief

Connection of a holding brake

Holding brakes are not appropriate for braking the motor. They only serve functional holding of the motor shaft. Additional measures are required for use in safety-oriented applications.

4.7 Power supply [X9]

Logic supply – protective extra-low voltage (PELV)

Warning
Danger of electric shock

- Use for the electrical power supply only PELV circuits in accordance with EN 60206-1 (Protective Extra-Low Voltage, PELV).
- Also observe the general requirements for PELV circuits as per EN 60204-1.
- Use only voltage sources that ensure a reliable electric separation of operating voltage in accordance with EN 60206-1.

Through the use of PELV circuits, protection from electric shock (protection from direct and indirect contact) in accordance with EN 60206-1 is ensured (Electrical equipment of machines. General requirements). A 24 V power supply unit used in the system must meet the requirements of EN 60204-1 for DC power supply units (behaviour in case of voltage interruptions, etc.).

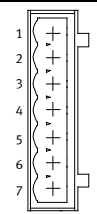
[X9]	Pin	Value	Description	
	1	L1	single-phase	Mains voltage connection for intermediate circuit voltage
	2	N	95 ... 250 V AC	
	3	IC+	320 V DC (max. 400 V DC)	Connection for external braking resistor → Description GDPC-CMMD-AS-HW-... Not short-circuit proof against L1, N, PE
	4	BR-CH	0 V/400 V, max. 4 A	
	5	PE	PE	Mains-side PE connection
	6	24 V	+24 V/3.6 A	Supply of the control section, DOUT..., etc.
	7	0 V	GND	Common reference potential L1/24 V

4.8 Master/slave interface [X10.1/2]

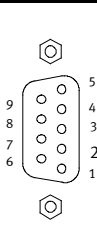
[X10.1/2]	Pin	Description	
	1	A/CLK/CW	Tracking signal A/pulse CLK/steps CW
	2	B/DIR/CCW	Tracking signal B/direction DIR/steps CCW
	3	N	Incremental encoder zero pulse N
	4	GND ¹⁾	Reference GND for incremental encoder
	5	VCC	Auxiliary supply, maximum load 100 mA
	6	#A/#CLK/#CW	Tracking signal A/pulse CLK/steps clockwise CW
	7	#B/#DIR/#CCW	Tracking signal B/direction DIR/steps CCW
	8	#N	Zero pulse N
	9	GND ¹⁾	Screening for the connecting cable

1) Pin 4 and pin 9 are connected internally

5 Commissioning



Note

Danger from unexpected movement of the motor or axis

- Make sure that the movement does not endanger anyone.
- Parameterise the motor controller with the Festo Configuration Tool (FCT) before enabling the controller via DIN5 [X1.1/2] Pin 9.
- Bypassing of safety equipment is impermissible
Recommendation for first commissioning without safety equipment
→ Section 4.3



Note

Damage to the motor controller

The motor controller is damaged in case of

- excessive operating voltage
- polarity reversal of the operating voltage connections
- interchange of operating voltage and motor connections
- short circuits in the motor circuit between the motor phases and PE
- Comply with the specified values for the supply voltage.
- Before switching on, check the connections [X9] and [X6.1/2].
- Check to ensure there is no PE short in the motor connection circuit.

Before switching on the power supply:

Check the installation of the motor controller:

- Check all connections.
- Connect all PE protective conductors, even for brief measuring and test purposes.
- Mounted module or cover plate on the card slot [EXT1/2]. Mounted line on [X9] and [X6.1/2].

Checking readiness to operate

1. Make sure that the controller enable is switched off (controller enable: DIN 5 [X1.1/2] Pin 9).
2. Switch on the power supplies of all devices. The READY LED on the front of the device should now light up.

If the READY LED is not lit, there is a malfunction. If an “E” appears in the 7-segments display followed by a sequence of numbers, this is an error message and you must eliminate the cause of the error.



Additional steps for preparation of commissioning can be found in the
→ Function description GDCP-CMMS/D-FW- ...

6 Obligations of the operator for the safety function

The functionality of the safety device is to be checked at adequate intervals. It is the responsibility of the operator to choose the type of check and time intervals in the specified time period. The check is to be conducted so the excellent functioning of the safety device in interaction with all the components can be verified. Recommendation: Carry out a performance test at least every 24 hours.

7 Diagnostics and fault clearance

No.	Message group	Cause/measure
01-x	Internal error – stack overflow	Load approved firmware.
02-x	Undervoltage in intermediate circuit	Check power supply, intermediate circuit voltage, undervoltage monitoring (threshold value).
03-x	Temperature monitoring, motor	Check parameterisation (current regulator, limits).
04-x	Temperature monitoring, electronics	Check installation conditions and cylinder sizing.
05-x	Internal power supply	Check 24 V logic supply. If error is present without connected peripheral equipment → Repair.
06-x	Intermediate circuit (over-current)	Check motor, cable and motor controller.
07-x	Intermediate circuit (overvoltage)	Check design and connection of the braking resistor.
08-x	Angle encoder	Check encoder and encoder signals.
11-x	Homing	Check homing, switch arrangement.
12-x	CAN	Re-start CAN controller. Check CAN configuration in the controller. Check wiring.
14-x	Motor identification	Check intermediate circuit voltage, encoder cable. Motor blocked, e.g. holding brake does not release?
16-x	Initialization	Load firmware again. Hardware defective?
17-x	Following error monitoring	Increase error window. Parameterise acceleration to be less. Motor overloaded?
18-x	Temperature monitoring	Check installation conditions.
19-x	I ² t monitoring	Motor/mechanics blocked or sluggish?
21-x	Current measurement	If the error occurs repeatedly → Hardware defective.
22-x	PROFIBUS	Check slave address, bus termination, cabling.
25-x	Firmware	Update the firmware.
26-x	Data flash	Load factory setting. Hardware defective?
29-x	SD card	Check SD card.
31-x	I ² t monitoring	Check motor and mechanical system.
32-x	Intermediate circuit	Check mains voltage/power supply, braking resistor.
35-x	Fast stop	Check parameterisation.
40-x	Software end position	Check target data and positioning range.
41-x	Path program	Check parameterisation.

No.	Message group	Cause/measure
42-x	Positioning	Parameterisation/sequence control, homing?
43-x	Limit switch error	Check parameterisation, wiring and limit switches.
45-x	STO error	Check activation; the error must not recur.
64-x	DeviceNet error	Check configuration and network.
65-x	DeviceNet error	Check configuration and network.
70-x	Operating mode error	Check factor group and impermissible change.
76-x	SSIO error	Check wiring and screening.
79-x	RS232 error	Check wiring and transferred data.

8 Repair and disposal



Repair or maintenance of the motor controller is not permissible. If required, replace the motor controller.



Observe the local regulations for environmentally friendly disposal of electronic components.

9 Technical data



The complete technical data on the CMMD-AS → Mounting and installation description GDCP-CMMD-AS-HW-....

When using the safety function, observe the special technical data and restrictions on environmental conditions in dependence on required output nominal power in the description STO → GDCP-CMMD-AS-S1-...

Safety reference data and safety specifications

Safety function	STO	Safely switched off torque (STO, Safe Torque Off)
Category	3	Grading in categories in accordance with EN ISO 13849-1
Performance Level	PL d	Performance level in accordance with EN ISO 13849-1
T [Years]	20	Proof test interval duration of use in accordance with EN ISO 13849-1
MTTF _d [Years]	2521	Mean time to dangerous failure.
Due to the service life of the internal switching relay, the safety data for the STO function apply for an annual actuation rate of $n_{op} = 500,000 / a$ (CMMD-AS-...from Rev 02).		
Type test	The functional safety engineering of the product has been certified by an independent testing authority (certificate → www.festo.com/sp).	
Reliable component	yes, for the STO safety function	

General technical data

Product conformity and certifications	
CE marking (declaration of conformity → www.festo.com/sp)	In accordance with EU Machinery Directive 2006/42/EC In accordance with EU Low Voltage Directive 2006/95/EC In accordance with EU EMC Directive 2004/108/EC
The device is intended for use in an industrial environment. Measures for interference suppression may need to be implemented in residential areas.	
Operating and environmental conditions	
Permissible setup altitude above sea level	
with rated output [m]	1000
with power reduction [m]	1000 ... 2000
Air humidity [%]	0 ... 90 (non-condensing)
Degree of protection	IP20
Degree of contamination	2
Ambient temperature	
with nominal power [°C]	0 ... +40
with power reduction [°C]	+40 ... +50
Storage temperature [°C]	-25 ... +70
Vibration and resistance to shocks	
Operation	in accordance with EN 61800-5-1, section 5.2.6.4

Power supply/braking resistor [X9]

Load voltage supply	
Input voltage range	[V AC] 95 ... 250 (single-phase)
Nominal current	[A] 10
Mains frequency	[Hz] 50 ... 60
Logic supply	
Nominal voltage	[V DC] 24 ± 20 %
Current consumption (outputs unloaded, without holding brake)	[A] 0.7
Peak current (incl. holding brake)	[A] 3.6
Connection for external braking resistor	
Braking resistor	[Ω] ≥ 100
Pulse power (for 500 ms)	[W] ≤ 1600
Nominal power	[W] ≤ 100
Operating voltage	[V DC] 400