

Terminal CPX

Input module CPX-F8DE-P

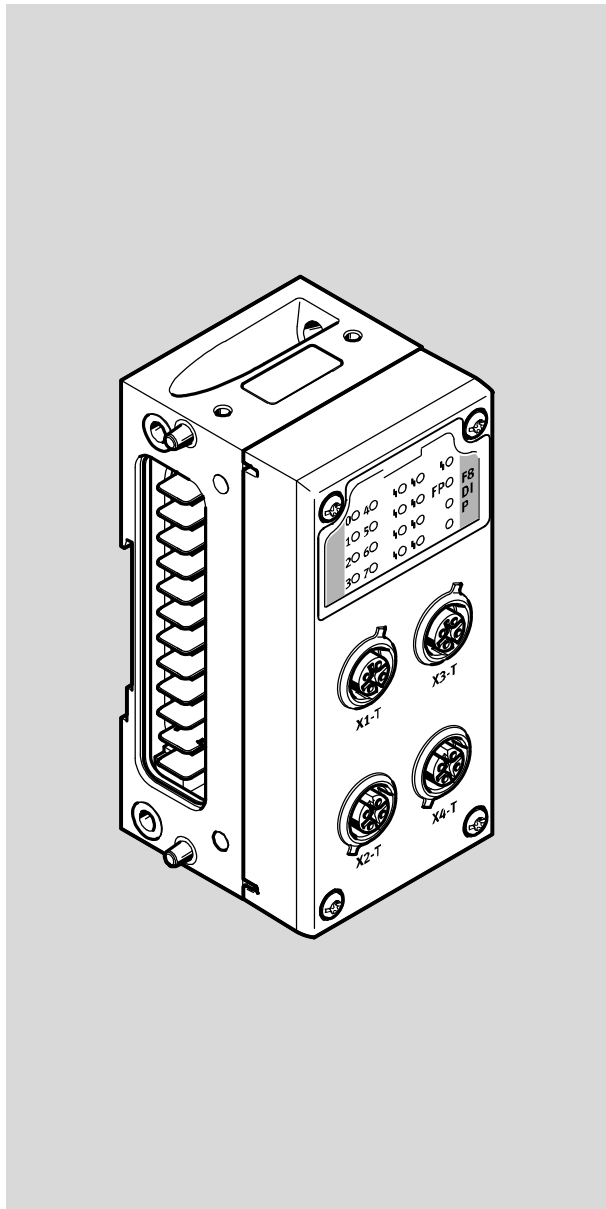

FESTO

Description

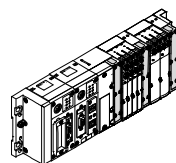

8035497
en 1610a
[8066145]

Contents and general instructions

Translation of the original instructions

Original de

Version en 1610a

Designation P.BE-CPX-F8DE-P-EN

Order no. 8035497

© (Festo AG & Co., 73726 Esslingen, Germany, 2016)

Internet: www.festo.com

e-mail: service_international@festo.com

Reproduction, distribution and utilisation of this document, as well as the communication of its contents to others without explicit authorisation, is prohibited. Offenders will be held liable for damages. All rights are reserved, in particular the right to file patent, utility model or registered design applications.

CAGE CLAMP®, PI PROFIBUS PROFINET®, SIEMENS® are registered trademarks of the respective trademark owners in certain countries.

Contents

General safety instructions	VI
Intended use	VII
Rules for product configuration	VIII
Possible misuse	X
Achievable safety classification	XI
Failures due to a common cause (Common Cause Failure – CCF)	XIII
Requirements for product use	XIII
Transport and storage conditions	XVI
Service	XVI
Range of application and certifications	XVI
Quoted guidelines and standards	XVIII
Product identification	XVIII
Instructions on this description	XXI
Important user information	XXII
Product specific terms and abbreviations	XXIV
1. System overview CPX-F8DE-P	1-1
1.1 CPX terminal with CPX-F8DE-P	1-3
1.1.1 Layout of the input module	1-3
1.1.2 Components	1-4
1.1.3 Supported product versions from CPX	1-8
1.1.4 Required bus topology (control loop system)	1-10
1.2 PROFIsafe	1-11
1.2.1 Safety profile PROFIsafe	1-11
1.2.2 Process image (I/O image)	1-12
1.2.3 Bit pattern of the output and input data (F-user data)	1-13
1.2.4 Channel-wise passivation	1-15
1.3 Functional method of the input module	1-17
1.3.1 Safe system status	1-18
1.3.2 Overview of applications	1-18
1.3.3 Details of the function modes	1-20
1.3.4 Use of switching signals	1-39
1.3.5 Channel bundling	1-40

1.4	Application examples	1-41
1.4.1	Control console	1-41
1.4.2	rotary indexing table	1-43
1.4.3	Limit position switch	1-45
1.4.4	Light curtain	1-46
1.4.5	Acknowledge button with request	1-47
1.4.6	2 two-wire sensors	1-48
1.4.7	2 protective doors on one channel pair	1-48
1.4.8	Protective door with two NO switches	1-49
2.	Installation	2-1
2.1	General instructions on installation	2-3
2.1.1	Module-related rules for configuration	2-4
2.2	Electrical connection and display components	2-5
2.2.1	Pin allocation on connection block CPX-M-AB-4-M12X2-5POL-T ..	2-6
2.2.2	Pin allocation on connection block CPX-M-AB-4-M12X2-5POL	2-7
2.2.3	Pin allocation on connection block CPX-AB-8-KL-4POL	2-8
2.3	Installation of the electronic module	2-9
2.3.1	Dismantling the electronics module	2-10
2.3.2	Mounting the electronics module	2-10
2.4	Set PROFI-safe address	2-11
2.5	Connection of sensors	2-13
2.5.1	Ensuring the protection class	2-14
3.	Commissioning	3-1
3.1	General instructions	3-3
3.2	Device master file (GSDML and GSD)	3-4
3.3	Module identifiers	3-4
3.4	Preparing for commissioning	3-5
3.5	Commissioning steps	3-6
3.6	Set the PROFI-safe parameters	3-7
3.7	Interrogation of the CPX module parameters	3-9
3.7.1	Parameter and signal display with the operator unit CPX-MMI-1 ..	3-11

3.8	Configuration with Siemens STEP 7 (example)	3-13
3.8.1	Addressing example	3-16
4.	Operation	4-1
4.1	LED status display	4-3
4.1.1	Behaviour during the start-up phase (Startup)	4-4
4.1.2	Normal operating status	4-4
5.	Diagnostics and error handling	5-1
5.1	Overview	5-3
5.2	Error characteristics	5-4
5.3	Diagnosis via LEDs	5-6
5.3.1	Behaviour in response to original module faults	5-10
5.3.2	Behaviour in response to channel faults	5-11
5.4	Diagnostics via the bus node	5-13
5.4.1	Diagnostics with the operator unit CPX-MMI	5-13
6.	Service, repair, waste management	6-1
6.1	Service	6-3
6.2	Repair	6-3
6.3	Disposal	6-4
A.	Technical appendix	A-1
A.1	Technical data	A-3
A.1.1	Safety characteristics	A-3
A.1.2	Characteristic values of the input module	A-5
A.2	Technical data of the connection blocks	A-8
B.	Index	B-1

General safety instructions



Warning

Nonobservance of safety instructions can result in death, serious injuries or heavy material damage.

- Always observe all safety instructions and warnings!
- For technical safety requirements, refer to the short description → P.BE-CPX-F8DE-P-...



Note

Electronic modules include electrostatically sensitive devices. Incorrect handling can cause damage to the electronics modules.

- Observe the handling specifications for electrostatically sensitive devices.
- Discharge yourself electrostatically before installing or disassembling modules to protect the modules.



Observe the regulations for the electrical supply .(Protective Extra-Low Voltage, PELV) of CPX terminals in the CPX system description P.BE-CPX-SYS-...

Intended use

The input module CPX-F8DE-P is intended for use to reliably acquire and evaluate signals of connected sensors.

The input module provides up to eight secure inputs that can be used by a primary safety control unit in a safety function. Communication with that primary safety control unit is performed by the secure protocol PROFIsafe via a PROFIBUS or PROFINET IO field bus connection.

The inputs on the input module can be combined for multi-channel sensor applications. In each case, 2 inputs form a channel pair that can be set separately with one of 11 function modes. These function modes have an influence on the evaluation of input signals, and optionally on the generation of clock signals.

The characteristics of the inputs comply with standard IEC 61131-2 for Type 2 digital inputs.

The input module CPX-F8DE-P is a product with safety-related functions. The input module is intended for installation in machines or automated systems and may be used only as follows:

- in excellent technical condition
- In original condition, without unauthorised modifications
- only in the configurations named in this description
→ Chapter 1.3.3
- within the limits of the product defined by the technical data → Appendix A.1
- in an industrial environment.



Note

- Observe that the safety engineering system limits of the output module are also its physical limits.

Responsibility for use of the input module in a safety function is a matter for the user.

Rules for product configuration

Operation of the output module CPX-F8DE-P is permissible only in CPX terminals from Festo of the variant .

Operation of the CPX-F8DE-P is permissible only in combination with the following PROFIsafe-capable CPX bus nodes (bus node rating plate):

bus node	from Revision	Network protocol
CPX-FB13 ¹⁾	30	PROFIBUS
CPX-FB33 ²⁾	21	PROFINET IO
CPX-M-FB34 ²⁾	21	PROFINET IO
CPX-M-FB35 ²⁾	21	PROFINET IO
¹⁾ → Description P.BE-CPX-FB13... ²⁾ → Description P.BE-CPX-PNIO...		

Tab. 0/1: Permissible PROFIsafe-capable CPX bus nodes

- Only use for manifold blocks implemented in metal – e. g. B. CPX-M-GE-EV → Chapter 1.1.2.
- Comply with all technical data → Appendix A.1. Otherwise, operative malfunctions can occur.

Operation of the CPX-F8DE-P is only possible with the following manifold blocks:

Manifold block	Application examples
CPX-M-AB-4-M12X2-5POL-T	Connection of OSSD-sensors with a current consumption of up to 0.7 A – Power supply via contacts T0, T2, T4, T6 Connection of sensors for mechanical switch contacts – Clock signals via contacts T0 ... T7
CPX-M-AB-4-M12X2-5POL	Connection of OSSD-sensors with a current consumption of up to 2 A
CPX-AB-8-KL-4POL	Connection of sensors via terminal strip
CPX-AB-ID-P	Setting of a coded identifier using an 8x DIL switch – It is not possible to connect sensors

Tab. 0/2: Permitted connection blocks



Further information about the supported product variants of CPX can be found in Chapter 1.1.3.

Possible misuse

The following applications are NOT intended use:

- use outdoors
- use in non-industrial areas
- use outside the limits of the product defined in the technical data
- use in inappropriate function modes
- unauthorised modifications.



Note

The use of connection and manifold blocks that are not named is **not permissible** → Tab. 1/1 and Tab. 1/3.



Note

In the following cases, the use of the input module CPX-F8DE-P for formation of safety circuits is **not permissible**:

- in a CPX terminal equipped with CPX-FEC or CPX-CEC
- in a CPX terminal of variant P
- in other than the named configurations
→ Chapter 1.3.3, Function modes.



Note

In the event of damage caused by unauthorised manipulation or other than intended use, the guarantee is invalidated and the manufacturer will not be liable for damages.

Achievable safety classification

With the CPX-F8DE-P, safety functions can be implemented up to:

- Performance Level e, Cat. 4 in accordance with EN ISO 13849-1
- Safety integrity level SIL 3 in accordance with EN 61508
- Performance limit SIL CL3 in accordance with EN 62061.

The attainable safety level of the entire safety system depends on the function mode setting of other components used to implement the safety function.

- Make sure that the overall safety function of the system is analysed and validated.
It is the responsibility of the operator to determine and verify the required safety rating (safety integrity level, performance level and category) of the system.
- Note the residual risks in your system that remain despite measures taken to integrate safety during design and building, despite safety precautions and despite supplementary protective measures.
These residual risks are also influenced by your safety specifications and the safety characteristics of your system.



Note about retention of a safety classification

- Test the operational capability of the safety equipment at adequate intervals.

Recommendation:

- At least once per year for PL d
- At least once per month for PL e

Selecting the type and time intervals of these tests is the responsibility of the operator.

- Conduct the tests in such a way that flawless functioning of the safety device can be verified and documented in interaction with all components.
- Ensure that, after every safety request, self-diagnosis initiates troubleshooting and a reboot of the system under the supervision of the personnel responsible.

Failures due to a common cause (Common Cause Failure – CCF)

Common cause failures cause the loss of the safety function, since all channels in a multi-channel system fail simultaneously.

Through the following measures, you ensure that common cause failures are avoided:

- Comply with operating voltage range
- Comply with signal voltage range
- Comply with temperature and environmental conditions.

Additional measures for avoidance of common cause faults may result from the application.

Requirements for product use

- Make this description available to the design engineer, installation technician and personnel responsible for commissioning the machine or system in which this product is used.
- Make sure that the specifications of the documentation are always complied with. Also comply with the documentation for the other components and modules (e.g. bus nodes, pneumatics).
- Take into consideration the legal regulations applicable for the installation site as well as:
 - regulations and standards
 - Regulations of the testing organisations and insurers
 - national specifications.
- Remove all transport packing such as foils, caps, cardboard. The material used in the packaging has been specifically chosen for its recyclability (exception: oil paper = residual waste).

- Only properly trained and certified technicians are permitted to install this equipment.

To maintain the IP protection class:

- Screw the connection block on tight → Chapter 2.3
- Install cable tips and seals professionally
- Seal unused connections with cover caps.

Technical requirements

General technical requirements for correct and safe use of the product:

- Comply with all limits of the product defined by the technical data → Appendix A.1.
Only then is operation of the product in accordance with the relevant safety regulations ensured.
- When connecting standard auxiliary components, also observe the specified limit values for electrical connection values and environmental conditions.

Qualified specialists

The device may only be commissioned by trained control and automation technology professionals, who are familiar with:

- installation and operation of control systems
- the applicable regulations for operating safety-engineered systems
- the applicable regulations for accident prevention and industrial safety
- the documentation for the product.



Note

Work on safety-related systems may only be carried out by authorised specialists trained in safety engineering.

Transport and storage conditions

- Protect the product during transport and storage from excessive stress factors, such as:
 - mechanical loads
 - impermissible temperatures
 - moisture
 - aggressive atmospheres.
- Store and transport the product in its original packaging. The original packaging offers sufficient protection from typical stresses.

Service

- In the event of technical problems, contact your local Festo Service centre.

Range of application and certifications

This product is a safety device as defined in the Machinery Directive 2006/42/EC and carries the CE marking.



Safety-related standards and test values with which the product complies and which it satisfied can be found in Technical Data, → Appendix A.1. The product-related EC guidelines and standards are itemized in the Declaration of Conformity. The certificates and the Declaration of Conformity relating to this product can be found on the Internet → www.festo.com/sp

- Note that only the input module CPX-F8DE-P is required to comply with these standards.

Certain configurations of the product have been certified by Underwriters Laboratories Inc. (UL) for the USA and Canada. These configurations bear the following mark:



UL Recognized Component Mark for Canada and the United States

**Only for connection to an NEC/CEC Class 2 supply.
Only connect to an NEC/CEC Class 2 circuit.**



Please Note

Observe the following if the UL requirements are to be complied with in your application:

- Rules for complying with the UL certification can be found in the separate UL-specific special documentation. The relevant technical data there also apply with priority unless they have some adverse influence on safety-related engineering characteristics.
- The technical data in this documentation may show values deviating from this.

Quoted guidelines and standards

Issue status	
EN ISO 13849-1:2008-06 + AC:2009	EN 61508 Parts 1-7:2010
EN ISO 13849-2:2012	EN 62061:2005-04 + AC:2010 + A1:2013
EN 574:1996 + A1:2008	IEC 61131-2:2007-07
EN 60529:1991 + A1:1999 + A2:2013	IEC 60204-1:2005/A1:2009 + AC:2010

Tab. 0/3: Guidelines and standards quoted in the document

Product identification

The product identifier is the module ID plus the product. The module ID can be seen through the transparent cover of the connection block.

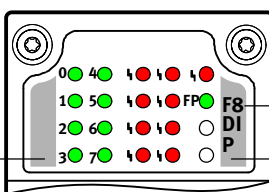
Module ID	Function
 <p>The diagram shows a top-down view of the CPX-F8DE-P input module. It features a 4x4 grid of indicator lights. The first column has lights numbered 0, 1, 2, and 3. The second column has lights numbered 4, 5, 6, and 7. The third and fourth columns each have four red lights. To the right of the grid, the text 'F8DI P' is printed. 'F8' is on a yellow background, while 'DI' and 'P' are on a white background. A box labeled '1' points to the 'F8DI P' text, and a box labeled '2' points to the yellow background.</p>	<ul style="list-style-type: none"> Module ID 1: F8DIP (F=Safety; 8=Number; D=Digital; I=Inputs; P=PROFIsafe) Yellow background 2 for identification of the safety function

Tab. 0/4: Module ID of the input module CPX-F8DE-P

The product label of the electronic module CPX-F8DE-P shows the following information:

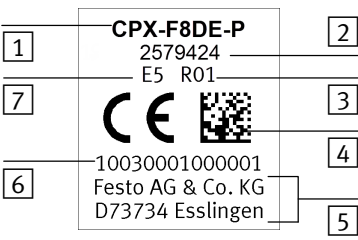
Product label (example)	Function
 <p>The image shows a product label for CPX-F8DE-P. It contains the following information: <ul style="list-style-type: none"> 1: CPX-F8DE-P 2: 2579424 7: E5 R01 3: A data matrix code (QR code) 4: 10030001000001 6: Festo AG & Co. KG 5: D73734 Esslingen </p>	<ul style="list-style-type: none"> - Product designation 1 - Part number 2¹⁾ - Revision code (here R01) 3 - Serial number represented as data matrix code 4²⁾ - Manufacturer and manufacturer's address 5 - 14-character serial number 6²⁾ - Manufacturing period (encrypted) 7³⁾ (here E5 = May 2014)
<p>¹⁾ Part number of the electronic module CPX-F8DE-P. ²⁾ The serial number enables the product to be traced. ³⁾ → Tab. 0/6 and Tab. 0/7</p>	

Tab. 0/5: Product description of the electronic module CPX-F8DE-P



You will find further information about this in the system description P.BE-CPX-SYS-...

Revision status

- Determining the revision status of a CPX module:
 - with the operating device CPX-MMI-1
→ [Module data][Revision]
 - with the appropriate configuration software
→ Module data, revision code
 - from the product label of the relevant module (in dismantled condition, → Tab. 0/5).
- Prior to replacement of a module, check to see if the revision code on the bus node complies with the requirements of the module → Tab. 0/1.

Manufacturing time period

The manufacturing period is encrypted on the product label in the form of a two-digit code → Tab. 0/5.

The letter specifies the manufacturing year and the character behind it (number or letter) the month of production.

Manufacturing year					
X = 2009	A = 2010	B = 2011	C = 2012	D = 2013	E = 2014
F = 2015	H = 2016	J = 2017	K = 2018	L = 2019	M = 2020

Tab. 0/6: Manufacturing year (20-year cycle)

Manufacturing month			
1	January	7	July
2	February	8	August
3	March	9	September
4	April	O	October
5	May	N	November
6	June	D	December

Tab. 0/7: Manufacturing month

Instructions on this description

This description contains general, basic information about how to operate, assemble and install the input module CPX-F8DE-P in conjunction with the CPX terminal and refers exclusively to the following revisions of the input module:

This description applies to the following product		
Product	Part number	Revision ¹⁾
CPX-F8DE-P	2597424	Rxx
¹⁾ xx stands for a numeral between 01 and 99 → Tab. 0/5.		

Tab. 0/8: Validity range

General basic information about how to operate, mount, install and commission CPX terminals can be found in the CPX system description.

Special information about commissioning, parameterisation and diagnostics of a CPX terminal with the bus node you are using can be found in the corresponding description for the bus node. Information about other CPX modules can be found in the separate description of each module.

Information about the pneumatics can be found in the corresponding description of pneumatics.



An overview of the structure of the user documentation for the CPX terminal can be found in the CPX system description P.BE-CPX-SYS-...

Important user information

Danger categories

This description includes instructions on the possible dangers which can occur if the product is used incorrectly. These instructions are marked with a signal word (Warning, Caution, etc.), printed on a shaded background and marked additionally with a pictogram. A distinction is made between the following danger warnings:



Warning

... means that non-observance can result in serious personal injury or damage to property.



Caution

... means that any failure to comply can result in personal injury or material damage.



Note

... means that failure to observe this instruction can result in damage to equipment.

In addition, the following pictogram marks passages in the text which describe activities with electrostatically sensitive devices:



Electrostatically sensitive devices: Incorrect handling can cause damage to devices.

Marking of special information

The following pictograms mark passages in the text which contain special information.

Pictograms



Information:
Recommendations, tips and references to other information sources.



Accessories:
Specifications on necessary or useful accessories for the Festo product.



Environment:
Information on the environmentally friendly use of Festo products.

Text designations

- Bullet points denote activities that can be carried out in any order.
- 1. Numerals label activities that must be carried out in the sequence specified.
- Arrowheads indicate general lists.

Product specific terms and abbreviations

Term/abbreviation	Significance
Acknowledgment	<p>Signal or procedure for depassivation. An acknowledgment from the user confirms that the input module can be brought back on line without danger, and/or that the input channel can be depassivized without any attendant risk.</p> <p>Once the complete input module has been passivized (→ Module-based passivation), acknowledgment involves regular → Reintegration (standard PROFIsafe process).</p> <p>If an input channel has been passivized (→ Channel-based passivation), acknowledgment involves the use of an acknowledgment signal on the process image → Chapter 1.2.3.</p>
Black channel	<p>The “black channel” is the name given to a transmission route without technical safety properties across which secure communication can be effected through the additional of failsafe mechanisms. For example, the field bus and the bus node (PROFIBUS or PROFINET IO) is part of the black channel across which PROFIsafe-communication is processed.</p>
Category	<p>Category (Cat.) is a measure of the resistance of a safety-aligned system to faults and of its subsequent behaviour after a fault, achieved through the structure of its component arrangement, fault detection and its reliability level → EN ISO 13849-1.</p>
Channel-wise passivation	<p>Type of passivation whereby only the channel pair of the affected defective input channel is passivized. The input module remains incorporated.</p> <p>To depassivize, an Acknowledge signal is required via the process image → Chapter 1.2.4.</p>
CRC signature	<p>Test value in security telegram from PROFIsafe to check integrity of telegram data (Cyclic Redundancy Check).</p>
Cross circuit	<p>Unintended electrical connection between signals. Cross circuits falsify the signal and cause failure of the safety function.</p>
Cross-circuit monitoring	<p>Function that detects possible cross-circuiting in the circuits connected to the device and that adopts a safe mode for the device and/or for the input channel affected. This can involve → Cycle monitoring and/or discrepancy monitoring.</p>
Cycle monitoring	<p>In the function modes with cycle monitoring, the inputs are used to detect if the actual cycle, an external cycle or the sensor power supply is present. The information is not released in the PROFIsafe input image until the anticipated cycle has been detected.</p>

Term/abbreviation	Significance
Cycle output	Output with a specific clock signal that is directed by a sensor and that is detected by a related input. This clock signal distinguishes itself from other cycles similar to functions and enables the diagnosis of cross-circuiting on switched signals.
Depassivation	In the operating mode “Passivation by channel”, depassivation involves setting the Acknowledge bit in the output data → Chapter 1.3.2. In the operating mode “Passivation by module”, depassivation involves → Reintegration.
Duct	→ Input channel
F-Device	Collective designation for safety-related devices → Safety control unit.
F-Host	Safety control unit for control of safety-related devices.
Forced dynamisation	Functional testing procedure to determine the switching capability of signals. With outputs, this procedure is often used in the form of test pulses, and for clocked inputs. Generally speaking, many safety-related signals can be found to have forced dynamic responses in order to detect short circuits and cross-circuiting.
F-System	Safety-related system that moves to a safe status when dangerous system and device errors occur.
GSDML/GSD	Device description file
Input channel	Input circuits in acc. with IEC 61131-2 for Type2 digital inputs to record signals from connected sensors.
Input image	→ Process image at input of safety control unit
i-Parameter	Technology-specific individual parameters for a defined device.

Term/abbreviation	Significance
Module-based passivation	<p>Type of passivation in which all channel pairs on the input module are passivized, e.g.:</p> <ul style="list-style-type: none"> – with errors in the safety-oriented communication (PROFIsafe) – with self-test errors – With channel faults where the “Channel-based passivation” is switched off. <p>With “Module-based passivation”, regular re-incorporation is required (standard process of PROFIsafe for acknowledgment).</p> <ul style="list-style-type: none"> – The input module sets the “Device_Fault” signal. – As soon as the cause of the fault has been remedied, the input module retracts the “Device_Fault” signal itself. With faults that cannot be remedied during runtime, “Device_Fault” remains set until the next time the system is powered down. – To ensure that substitute values (0) continue to be transmitted once the cause of the fault has been remedied, the safety control unit can transmit “Activate_FV” to the input module. The input module replies to this with “FV_Activated” until the safety control unit displays, with the “Activate_FV” signal, that safe operation with process values is possible once again.
NC	English abbreviation for normally-closed switch → Sensor
NO	English abbreviation for normally-open switch → Sensor
OSSD	Output Signal Switching Device. Sensor with autonomous line monitoring.
Output image	→ Process image at output of safety control unit
Passivation	<p>Safety function in which the input module CPX-F8DE-P adopts a safe status, depending on which fault occurs for all input channels (→ Module-based passivation) or only for defective input channels (→ Channel-based passivation). Instead of process values in such cases → Substitute values (0) are transmitted instead.</p>
Performance Level (PL ...)	<p>Discrete characteristics level that specifies the ability of safety-related parts of a safety control unit to perform a safety function under defined conditions. In EN ISO 13849-1 5 levels are defined. PL a is the lowest level and PL e is the highest level.</p>
Process error	The combination of monitored sensor signals is invalid.

Term/abbreviation	Significance
Process image	The process image is part of a controller's system memory. At the start of the cyclical program, the signal states of the input assemblies are transferred to the process diagram for the inputs. At the end of the cyclical program, the process diagram for the outputs are transferred to the output assemblies as the signal state.
PROFIBUS	Standard for field bus communication between control units (SPS/IPC) and devices in automation technology (PROcess Field BUS) ➔ www.profibus.com
PROFINET IO	Field bus standard based on Industrial Ethernet for communication between control units (SPS/IPC) and devices ➔ www.profinet.com
PROFIsafe	<p>Safety-based bus profile for PROFIBUS and PROFINET IO that, in conjunction with PROFIsafe-compliant devices (F-Host und F-Device) facilitates correct and reliable transmission of safety messages. Serving as mechanisms for safe transmission and error detection are:</p> <ul style="list-style-type: none"> – CRC signatures (data integrity check), – Consecutive numbering of safety-related messages, – Address data check ➔ PROFIsafe address – Time monitoring. <p>In case of errors, the F-Device can automatically trigger predefined safety measures. Based on the continuous numbering, receivers can tell whether they have received the messages in the correct sequence and completely. For this purpose, F-Host and F-Device have their own finite state machines that are synchronised with the help of a control and status byte. Correct synchronization is monitored by incorporation of counter values in the calculation of the CRC signature.</p>
PROFIsafe address	For identification of the addressee of a message, each PROFIsafe-capable device or module has a unique PROFIsafe address. The PROFIsafe address is specified in the configuration program and set at the PROFIsafe-capable device or module through DIL switches. Configuration errors can be determined automatically through comparison between the set and actual configuration.
PROFIsafe monitoring time	Monitoring time for safety-related communication between F-Host and F-Device
Reentry	Changeover from substitute values to process values = depassivation (➔ Passivation). Reintegration is a standard process of PROFIsafe to depassivize a passivized module (PROFIsafe specification).
Reintegration	Reintegration is the standard PROFIsafe process for the reincorporation of passivized modules.

Term/abbreviation	Significance
Replacement value	Preset safe value that replaces the real process value and/or the programmed value in the event of a malfunction and when booting safety-related systems. With CPX-F8DE-P (digital inputs) a value of 0 is transmitted in the input image.
Safe status	Status in which a system works with secured process values or safe substitute values to prevent potentially dangerous movements or other types of hazard.
Safety chain	All elements of a safety unit.
Safety circuit	Total of all signals processed for a safety function and their sources. Example: 2 door switches including wiring and 2 related discrepancy-monitored inputs, their monitoring and the related technical safety actuators.
Safety classification	An indicator of Functional Safety comprising → Performance Level, → Category and → Safety integrity level.
Safety control	Programmable controller with special elements for processing safe input information into safe output information.
Safety integrity	Effectiveness of safety functions in a safety-related system under requirement-based parameters governing the use of a product (e.g. voltage, temperature, industrial environments, PELV)
Safety integrity level	Safety Integrity Level for safety-related systems in acc. with EN 61508. There are 4 levels (SIL 1 thru SIL 4). SIL 1 is the lowest level and SIL 4 is the highest level of safety integrity. The higher the level the less probable it is that the system will fail in a dangerous manner.
Safety-oriented control circuit	Safety circuit including safety-oriented activation through the controller.
Safety program	Safety-based user program in the F-host.
Safety-related communication	Exchange of safety-related messages between F-Host and F-Device (e.g. via → PROFIsafe).
Sensor	In the context of a technical safety evaluation, a sensor is a device that converts the technical safety status of a system into digital switch signals, e.g. emergency stop switch, light curtain, door switch.
Short circuit	Connection of switching points with normally different electrical potentials, e.g. of 0 V and 24 V of one voltage source.

Term/abbreviation	Significance
SIL	Safety Integrity Level → SIL.
SIL CL	SIL Claim Limit: Claim limit for sub-systems in a safety-related electrical control system.
Test pulse	Fast switch impulses (e.g. from OSSD sensor) for monitoring of switchability and for detection of cross-circuiting → Forced dynamic response. Test impulses are tolerate for up to a max. duration of 0.7 ms.
Wire break detection	Function that, under certain conditions, detects and reports a cable break.

Tab. 0/9: Product-specific terms and abbreviations

Contents and general instructions

System overview CPX-F8DE-P

Chapter 1

Contents

1.	System overview CPX-F8DE-P	1-1
1.1	CPX terminal with CPX-F8DE-P	1-3
1.1.1	Layout of the input module	1-3
1.1.2	Components	1-4
1.1.3	Supported product versions from CPX	1-8
1.1.4	Required bus topology (control loop system)	1-10
1.2	PROFIsafe	1-11
1.2.1	Safety profile PROFIsafe	1-11
1.2.2	Process image (I/O image)	1-12
1.2.3	Bit pattern of the output and input data (F-user data)	1-13
1.2.4	Channel-wise passivation	1-15
1.3	Functional method of the input module	1-17
1.3.1	Safe system status	1-18
1.3.2	Overview of applications	1-18
1.3.3	Details of the function modes	1-20
1.3.4	Use of switching signals	1-39
1.3.5	Channel bundling	1-40
1.4	Application examples	1-41
1.4.1	Control console	1-41
1.4.2	rotary indexing table	1-43
1.4.3	Limit position switch	1-45
1.4.4	Light curtain	1-46
1.4.5	Acknowledge button with request	1-47
1.4.6	2 two-wire sensors	1-48
1.4.7	2 protective doors on one channel pair	1-48
1.4.8	Protective door with two NO switches	1-49

1.1 CPX terminal with CPX-F8DE-P

1.1.1 Layout of the input module

- 1 Manifold block
CPX-M-AB-4-
M12X2-5POL(-T)
- 2 Connection block
CPX-AB-8-KL-4POL
- 3 Connection block
CPX-AB-ID-P with
internal 8x DIL
switch for coding
- 4 Electronics
module
CPX-F8DE-P
- 5 10-element DIL
switch for
PROFIsafe
address
- 6 Manifold block
with bus bars, e.g.
CPX-M-GE-EV
- 7 Product labelling
- 8 Electrical plug
connector
- 9 LEDs on the input
module
- 10 Mounting screws

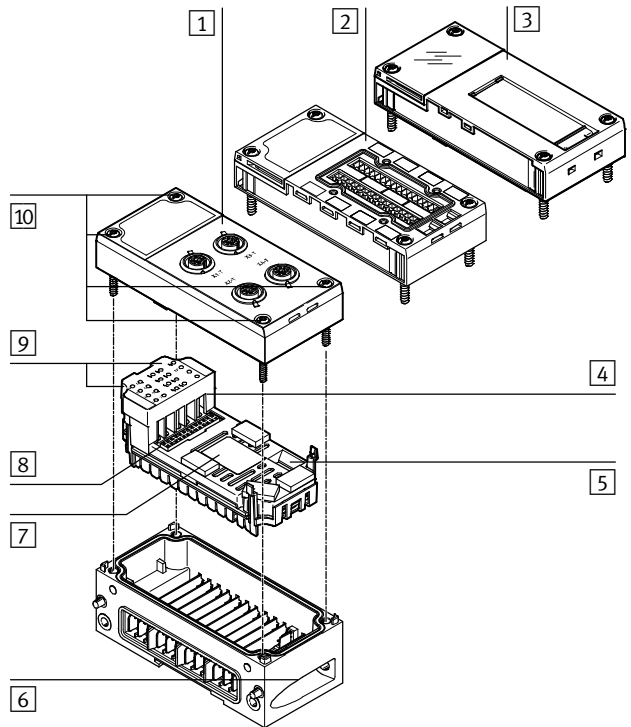

Fig. 1/1: Layout of the input module CPX-F8DE-P

- Only use manifold blocks implemented in metal.

1. System overview CPX-F8DE-P

1.1.2 Components

Connection blocks

The connection block provides the input module with connection technology. Operation of the CPX-F8DE-P is only possible with the following connection blocks:

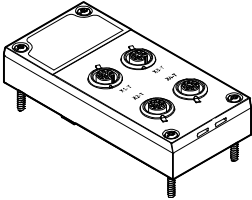
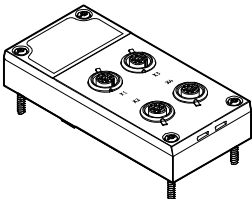
Connection block	Description
 <p>CPX-M-AB-4-M12X2-5POL-T</p>	<p>M12 metal connection technology</p> <ul style="list-style-type: none">– 4 M12 sockets with metal thread, 5-pin– for the use of sensors with static or switched 24V power supply– for use of sensors with a current consumption up to 0.7A– Protection class IP65 when using cover caps ISK-M12 for unused connections
 <p>CPX-M-AB-4-M12X2-5POL</p>	<p>M12 metal connection technology</p> <ul style="list-style-type: none">– 4 M12 sockets with metal thread, 5-pin– for the use of sensors that only have static 24V power supply– for use of electronic sensors with a current consumption up to 2A– Protection class IP65 when using cover caps ISK-M12 for unused connections

1. System overview CPX-F8DE-P

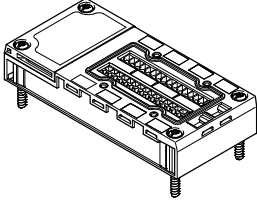
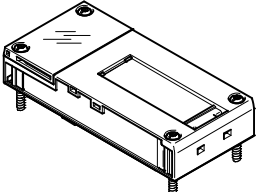
Connection block	Description
<p data-bbox="140 359 308 379">CPX-AB-8-KL-4POL</p> 	<p data-bbox="427 359 756 379">Terminal strip connection technology</p> <ul data-bbox="427 383 1013 606" style="list-style-type: none"><li data-bbox="427 383 756 403">– 2 terminal strips, 16-pin (4 x 4-pin)<li data-bbox="427 406 985 427">– all cores can be placed individually in a spring tension clamp<li data-bbox="427 430 996 483">– Connections are arranged in groups of 4, one functional-earth connection per group<li data-bbox="427 486 1013 539">– for the use of sensors with static or switched 24V power supply<li data-bbox="427 542 974 595">– for the use of sensors with mechanical switch contacts and electronic sensors with a current consumption up to 0.7A<li data-bbox="427 598 683 619">– Degree of protection IP20<li data-bbox="427 622 901 643">– Degree of protection IP65 with use of cover AK-8KL
<p data-bbox="140 641 252 662">CPX-AB-ID-P</p> 	<p data-bbox="427 641 862 662">Connection block without connection technology</p> <ul data-bbox="427 665 593 686" style="list-style-type: none"><li data-bbox="427 665 593 686">– coded identifier

Tab. 1/1: Permitted connection blocks

Information about electrical connection and display elements
➔ Chapter 2.2.

1. System overview CPX-F8DE-P

Electronics module

The electronic module contains the electronic components of the input module. It is connected to the Manifold block and the connection block by means of electric plug connectors.

Via a DIL switch the PROFIsafe address can be set directly on the electronics module → Chapter 2.4.

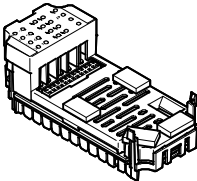
Electronics module	Description
<p data-bbox="87 608 194 630">CPX-F8DE-P</p> 	<ul style="list-style-type: none"><li data-bbox="367 608 598 630">– 8 digital input channels<li data-bbox="367 633 975 683">– Evaluation of the digital input channels with safety-related PLC via PROFIsafe<li data-bbox="367 686 762 708">– Status and error display per input channel<li data-bbox="367 711 575 734">– Module error display<li data-bbox="367 737 602 759">– Short circuit protection.

Tab. 1/2: Electronics module

Manifold blocks

A manifold block makes the mechanical and electrical connection to the CPX terminal.



Note

Malfunctions are possible due to lack of shielding.

- Only use manifold blocks implemented in metal.

1. System overview CPX-F8DE-P

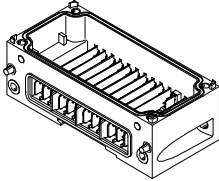
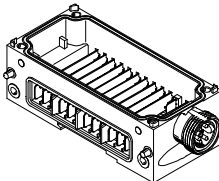
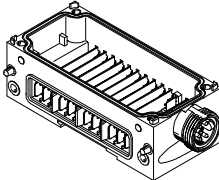
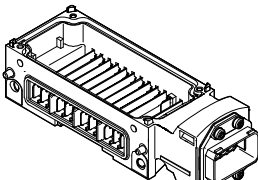
Manifold block	Description
<p data-bbox="140 355 260 376">CPX-M-GE-EV</p> 	<p data-bbox="427 355 692 376">without system power supply</p>
<p data-bbox="140 592 372 612">CPX-M-GE-EV-S-7/8-5POL</p> 	<p data-bbox="427 592 882 612">with system power supply, connection: 7/8" (5-pin)</p>
<p data-bbox="140 831 384 852">CPX-M-GE-EV-S-7/8-CIP-4P</p> 	<p data-bbox="427 831 882 852">with system power supply, connection: 7/8" (4-pin)</p>
<p data-bbox="140 1070 361 1091">CPX-M-GE-EV-S-PP-5POL</p> 	<p data-bbox="427 1070 818 1091">with system power supply: push-pull (5-pin)</p>

1. System overview CPX-F8DE-P

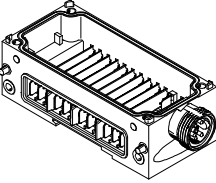
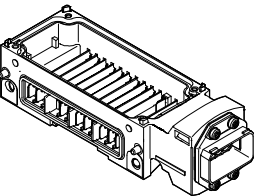
Manifold block	Description
CPX-M-GE-EV-Z-7/8-5POL 	with additional power supply, connection: 7/8" (5-pin)
CPX-M-GE-EV-Z-PP-5POL 	with additional power supply, connection: push-pull (5-pin)

Tab. 1/3: Permitted manifold blocks

1.1.3 Supported product versions from CPX

To activate the input module CPX-F8DE-P a PROFIBUS or PROFINET-compliant bus node is required. The CPX terminal must be equipped with one of the following bus nodes:

➔ Product label.

bus node	from Revision	Network protocol
CPX-FB13	30	PROFIBUS
CPX-FB33	21	PROFINET IO
CPX-M-FB34	21	PROFINET IO
CPX-M-FB35	21	PROFINET IO

Tab. 1/4: Bus node for control of the CPX-F8DE-P

1. System overview CPX-F8DE-P

The following product versions of the CPX terminal support operation of the input module in conjunction with the named bus nodes CPX-F8DE-P:

Product version	Description
Electrical terminal	Modular electrical terminal CPX (without pneumatics modules)
MPA-S-FB-VI	Valve terminal MPA-S with CPX modular electrical peripherals
VTSA-FB-VI VTSA-FB-NPT-VI	Valve terminal VTSA with CPX modular electrical peripherals
VTSA-F-FB-VI VTSA-F-FB-NPT-VI	Valve terminal VTSA-F with CPX modular electrical peripherals

Tab. 1/5: Supported product versions in combination with above bus node

Product versions	
Valve terminal	Valve types
MPA-S-FB-VI	MPA1, MPA2 on VMPA...-FB-EMG-...
VTSA-FB-VI	All up to width of 52 mm
VTSA-F-FB-VI	All up to width of 52 mm

Tab. 1/6: Supported product versions of the CPX terminal

1. System overview CPX-F8DE-P

1.1.4 Required bus topology (control loop system)

To set up safety-related systems, hardware and software components are required. E.g., a safety controller is needed (F-Host) with corresponding planning and programming tools.

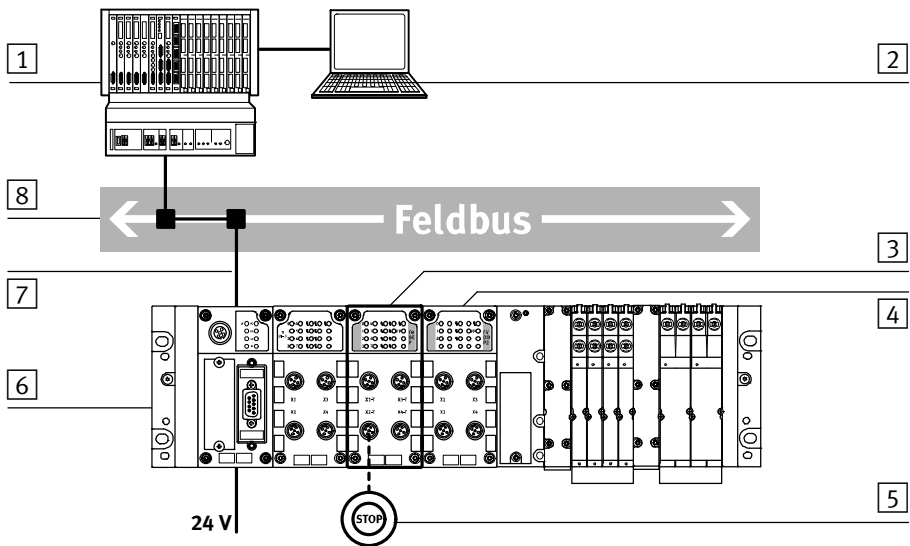

- | | |
|---|--|
| 1 Safety controller (F-Host) | 5 EMERGENCY STOP pushbutton (example) |
| 2 Safety Configuration Tool (for safety controller) | 6 CPX terminal with bus node for PROFIBUS or PROFINET IO |
| 3 Input module CPX-F8DE-P | 7 Embedded PROFIsafe data (black channel) |
| 4 Output module CPX-FVDA-P2 (example) | 8 PROFIBUS or PROFINET IO |

Fig. 1/2: Communication between safety controller and safety modules via PROFIsafe

1.2 PROFIsafe

Data exchange between the input module and the safety controller is made with the safety-related bus profile PROFIsafe from PROFIBUS or PROFINET IO.

1.2.1 Safety profile PROFIsafe

The PROFIsafe telegrams are embedded in standard telegrams and are directed via the so-called black channel from the safety controller to the input module. The black channel extends from the field bus connection on the safety controller via the bus node to the input module CPX-F8DE-P → Fig. 1/2. There the PROFIsafe telegrams are processed by the input module.

In addition to the process data, safety information is transmitted in the PROFIsafe telegram. For that reason, the CPX-F8DE-P assigns 6 bytes in the input image and 7 bytes in the output image of the CPX terminal → Fig. 1/3; [3], [4], [5].

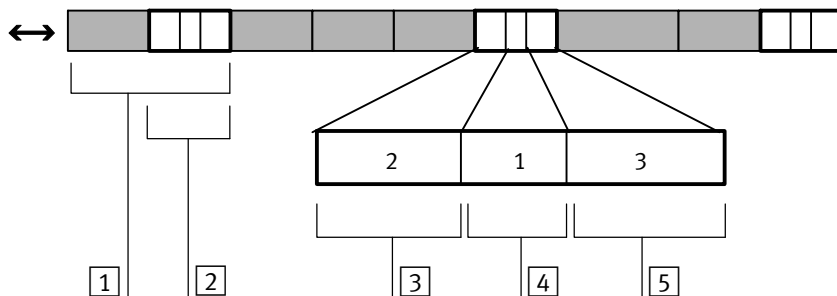

- | | |
|--|--|
| [1] Standard telegram with embedded PROFIsafe data | [3] 2 bytes for F usage data from the module
3 bytes for F usage data to the module |
| [2] Embedded PROFIsafe telegram | [4] 1 byte status or control byte |
| | [5] 3 bytes CRC signature (CRC2) |

Fig. 1/3: Telegram layout of the input module CPX-F8DE-P

1. System overview CPX-F8DE-P

Data are transmitted on the same physical basis as the transfer of process data to a standard module. There is a distinction to be made between the kind of data and the interpretation of that data by the F-Device (PROFIsafe slave).

For PROFIsafe communication in conjunction with input module CPX-F8DE-P the following applies:

- the module supports the PROFIsafe V2.4 bus profile in V2-mode
- Parametrisation on V1 mode is rejected.

1.2.2 Process image (I/O image)

Due to the safety mechanisms of PROFIsafe the input module CPX-F8DE-P in the process image of the CPX terminal assigns 7 bytes for outputs and 6 bytes for inputs.

Outputs consist of:

- 3 bytes of output data (F usage data, ➔ Tab. 1/7)
- 1 control byte (for PROFIsafe communication)
- 3 bytes of CRC (for PROFIsafe communication).

Inputs consist of:

- 2 bytes of input data (F usage data, ➔ Tab. 1/8)
- 1 status byte (for PROFIsafe communication)
- 3 bytes of CRC (for PROFIsafe communication).

Function modes are set via the output data from the input module.



1. System overview CPX-F8DE-P

1.2.3 Bit pattern of the output and input data (F-user data)

Output data

Byte 0 serves to activate channel-based passivation and to acknowledge channel errors → Chapter 1.2.4.

Bytes 1 and 2 serve to select the function modes for all channel pairs and are set as a 16-bit wide word by the F-host.

Bit samples for the output data									
Byte	Bit 7	Bit 6	Bit 5	Bit 4	Bit 3	Bit 2	Bit 1	Bit 0	
0	0	0	0	0	0	0	1/0	1/0	
	Operating mode: 1 = channel-based passivation 0 = module-based passivation								
	1 = Acknowledgment of a channel error								
1	8	4	2	1	8	4	2	1	
	Function mode for channel pair 7/6				Function mode for channel pair 5/4				
2	8	4	2	1	8	4	2	1	
	Function mode for channel pair 3/2				Function mode for channel pair 1/0				

Tab. 1/7: Bit pattern for output data (F usage data, bytes 0, 1 and 2)

- Ensure that the data in the output image contain a valid module configuration for your safety application.

1. System overview CPX-F8DE-P

Input data

Via bytes 0 the input module reflects the logical actual values as input module back to the F-Host → Tab. 1/8.

Corresponding to the input module, byte 1 receives qualification information.

Bit pattern of input data: byte 0 and byte 1								
Byte	Bit 7	Bit 6	Bit 5	Bit 4	Bit 3	Bit 2	Bit 1	Bit 0
0	E7	E5	E3	E1	E6	E4	E2	E0
Input image								
1	Q7	Q5	Q3	Q1	Q6	Q4	Q2	Q0
Qualification bits Qx = 1: Signal Ex is valid Qx = 0: Signal Ex is invalid, incorrect input function in accordance with function mode/ channel error/module fault								

Tab. 1/8: Bit pattern of input data (F-usage data, byte 0 and byte 1)

Byte 0 contains the logical status of the inputs in accordance with function mode. These input bits are only set to 1 if the related qualification bit is also set to 1.

Byte 1 contains the qualification bits. The qualification bits only change to 1 if no channel error is present, and if the channel was depassivized after a previous error in the channel.

Byte	Bit 7	Bit 6	Bit 5	Bit 4	Bit 3	Bit 2	Bit 1	Bit 0
0	0	0	E3	E1	0	0	E2	E0
1	1	1	1	1	1	1	1	1

Tab. 1/9: Input image for channel pairs E0/E1 and E2/ E3

1.2.4 Channel-wise passivation

Via bit 1 of byte 0 for output data (PAA) “channel-wise passivation” can be switched on or off → Tab. 1/7.

Channel-wise passivation disabled

While this function is disabled (0 = Off), in accordance with PROFIsafe specification and even when there is only one channel error, the input module switches all information on the input image into a safe status (= module-wise passivation).

- All inputs = 0
- All qualification bits = 0



Passivation in the event of a fault is based on PROFIsafe specification.

For troubleshooting

- Note diagnostic messages from module in the F-Host.

Channel-wise passivation enabled

If this function is enabled (1 = on) when a channel error occurs, the input module switches the input information of the affected channel pair to 0, depending on the function mode.

The input information of unaffected channel pairs does not change and the input module remains integrated.

The input module indicates via the input image the current channel error status to the control unit:

- All input bits relating to the channel bundle = 0
- All qualification bits relating to the channel bundle = 0

1. System overview CPX-F8DE-P

Acknowledgment sequence

When using the channel-wise passivation, acknowledgment is made with the help of the safety program via bit 0 from byte 0 of the output data (PAA) → Tab. 1/7.

The following description of the sequence shows the bits in the input and output depiction of the input module that are relevant to channel-wise passivation.

no.	Process	Channel-wise passivation ¹⁾	Electrical status at input	Status in the input image ²⁾	Qualification bit ²⁾	Acknowledgment of the channel fault ¹⁾
1	Module is not passivated	1 (active)	X	X	1	0
	Channel fault appears					
2	Module has detected the channel error	1 (active)	X	0	0	0
	F-Host detects the channel error in the assembly					
3	User eliminates a channel error					
	User acknowledges the channel error (at least 1 F-I/O clock signal)	1 (active)	X	0	0	1
4	Channel is no longer passivated	1 (active)	X	X	1	X
<p>The grey-marked cells emphasise the bits relevant for the respective table line. ¹⁾ Bit in output image → Tab. 1/7 ²⁾ Bit in input image → Tab. 1/8, byte 1 X: Signal can be 0 or 1</p>						

Tab. 1/10: Channel error acknowledgment – example

Automatic acknowledgment is possible by holding the acknowledgment bit permanently at “1”.

If acknowledged while an error is still present, the input image remains in safe mode. In the event of undesired automatic acknowledgment, a safety program must ensure that the safety controller cancels that acknowledgment.



Note

In the event of a restart of the F-Host (Stop → Run), the channel monitoring function of the input module CPX-F8DE-P also restarts.

If the cause of the error is still present, the channel error will be triggered again.

1.3 Functional method of the input module

The inputs on the input module are always evaluated using 2 independent internal channel paths. To this end, the input module is equipped with 2 processors that monitor one another continuously and can also monitor the input channels for cross-circuiting, depending on the selected function modes.

The input module is designed such that the input channels can provide either secure data or no data at all, even when a fault is present in the system, e.g. with:

- overvoltage, undervoltage, overload, short circuit and cross circuit
- Failure or malfunction of communication via PROFIsafe
- Failure or defect of individual safety-determining components of the input module.

1.3.1 Safe system status

Whenever a fault is diagnosed in the input information for the module, the reaction depends on the module operating mode selected:

- With the operating mode “Module-based passivation” (PAA byte 0, bit 1 = 0) that module passivation is performed in accordance with the PROFIsafe specification.
- With the “Channel-wise passivation” operating mode (PAA byte 0, bit 1 = 1) the affected channel bits (Ex, Qx) in the input image (PAE bytes 0 and 1) are set to logical zero.

With a diagnosed internal module error, module passivation is based on the PROFIsafe specification.

In the event of a massive stochastic failure of the module hardware, the system responds with a PROFIsafe timeout.

1.3.2 Overview of applications

The input module can be used for the following tasks:

- Connection of different switches and sensors to the safety chain
- Use of multi-channel sensor applications with up to 8 secure inputs, groupable and suitable for configuration with the help of 11 different function modes
- Use as an input module for a primary safety controller. Several input modules can be used together and these monitor mutually independent sensors.

The following overview constitutes a selection and lists some but not all possible applications.



1. System overview CPX-F8DE-P

no.	Application	Architecture	Type of contact	Function mode	Max. sensor applications
1	Pushbutton, switch, sensor	1oo1	Electronic	1; 2	8
		1oo1 T	Mechanical	3	8
		1oo1 D	antivalent	4	8
		1oo2	OSSD	5	4
		1oo2 T	Mechanical	6	4
2	Sensor with clock signal input	1oo1 T	OSSD	3	8
3	Emergency stop	1oo1 D	antivalent	4	8
		1oo2	OSSD	5	4
		1oo2 T	Mechanical	6	4
4	Light curtain	1oo2	OSSD	5	4
		1oo2 T	Mechanical	6	4
5	Two-hand control device of type IIIC according to EN 574	1oo2 D	antivalent	7	4
6	Safety door	1oo2 T robust	Mechanical	8	4
7	Operating mode switch, round switching table	1 of N	mechanical, electronic, OSSD	9	2
8	Tool detection	Identifier	mechanical, electronic, OSSD	10	1

Tab. 1/11: Possible applications with contact types and appropriate function modes

1. System overview CPX-F8DE-P

1.3.3 Details of the function modes

To create safety circuits with recommended sensors, the input module CPX-F8DE-P provides various function modes. These function modes can be set separately for each channel pair.

Recommended sensors	Function mode									
	1	2	3	4	5	6	7	8	9	10
Sensors with mechanical switch contacts	–	–	◇	✱	–	✱	✱	✱	✱	✱
Sensors with self-monitored electronic outputs	◇	◇	–	–	✱	–	–	–	✱	✱
Electronic 3-wire sensors with a readiness delay of < 23 ms or Electronic 2-wire sensors with a readiness delay of < 2 ms	–	–	◇	–	–	◇	–	◇	–	–
Additionally: – with polarity reversal protection in positive power supply connection or – without freewheel diode at sensor output.	–	–	–	✱	–	–	–	–	–	–
✱ Recommended function mode ◇ Can be used with low safety requirement										

Tab. 1/12: Recommended sensors



Note

The setting of function modes can restrict the selection of usable connection blocks.

- Make sure that the connection block required for the safety function is present.

1. System overview CPX-F8DE-P



Note

The following applies for all applications involving sensors and switches in combination with the corresponding function modes of the input module CPX-F8DE-P:

The achievable safety integrity level, Performance Level and category of your system are limited by the component of the safety chain with the lowest characteristic value.

- Only use switches and sensors that meet the technical safety requirements of the application.
- When using tried and tested components in accordance with EN 13849-2, Table D.3, calculate the safety rating from the respective manufacturer's specifications.

The technical specifications for the switches and sensors include information relating to safety considerations and operating conditions.



Note

Malfunctions are possible on unused inputs.

- Ensure that for unused channel pairs, it is always function mode 0 that is set.



On function modes with switching signals:

- Clock outputs T0, T2, T4 and T6 use different clock signals for each other and for T1/T3/T5/T7.
- Clock output signals T0, T2, T4 and T6 run different switching signals to one another, and in respect of T1/T3/T5/T7.



Note

In case of bit-wise programming of the function mode:

- Make sure that the mode switchover is performed within a PROFIsafe cycle. Otherwise, a short-term change into another function mode can occur, which can result in unexpected reactions. Consider this in your application.

Function mode 0 – no signal evaluation



When switching on the input module, all channel pairs are preset to this mode. This function mode serves for the initial commissioning of wiring and sensors.

Circuit diagram	Channel pair ports			
	T0/24 V	T2/24 V	T4/24 V	T6/24 V
	E1	E3	E5	E7
	0 V			
	E0	E2	E4	E6
	T1/FE	T3/FE	T5/FE	T7/FE

Tab. 1/13: Function mode 0

Both channels always produce a logical 0 as input information and a logical 1 as a qualifier in the input image.

The signals from connected sensors are only displayed via the status LEDs.

1. System overview CPX-F8DE-P

Functional safety

A safety-related evaluation is **not** conducted in function mode 0.

Function mode 1 – 1001 (T0, T2, T4, T6 static on)

Signal evaluation of up to 2 independent single-channel switches/sensors (NO or NC) per channel pair. T0, T2, T4, T6 run in this function mode on static 24 V DC.

Circuit diagram	Channel pair ports			
	T0/24 V	T2/24 V	T4/24 V	T6/24 V
	E1	E3	E5	E7
	0 V			
	E0	E2	E4	E6
	T1/FE	T3/FE	T5/FE	T7/FE

Tab. 1/14: Function mode 1 – 1001

Functional safety

- PL c, Cat. 1 / SIL 1
with switch/sensor operationally tried and tested in accordance with EN 13849-2, Table D.3,
and with wiring protection of the customer application in accordance with EN 13849-2, Table D.4

Function mode 2 – 1oo1 Test (T0, T2, T4, T6 static off)

Signal evaluation of up to 2 independent single-channel switches/sensors (NO or NC) per channel pair. In this function mode, T0, T2, T4, T6 are not connected to any voltage.

Circuit diagram	Channel pair ports			
	T0	T2	T4	T6
	E1	E3	E5	E7
	0 V			
	E0	E2	E4	E6
		T1/FE	T3/FE	T5/FE

Tab. 1/15: Function mode 2 – 1oo1 Test



Function mode 2 can be used as a test mode when you connect sensors for function mode 1

This way, a safety controller used alternately in function modes 1 and 2 can generate user-specific test signals and evaluate if a zero crossing has taken place.

Software-generated test signals only work with the following connection blocks:

- CPX-M-AB-4-M12X2-5POL-T
- CPX-AB-8-KL-4POL.



Note

During the test period, safety requirements cannot be evaluated with the safety controller.

Function mode 2 can alternatively be used for resetting sensors with self-monitoring electronic outputs.

Functional safety

- PL c, Cat. 1 / SIL 1
with switch/sensor operationally tried and tested in accordance with EN 13849-2, Table D.3,
and with wiring protection of the customer application in accordance with EN 13849-2, Table D.4

Function mode 3 – 1oo1 T (with clock signal monitoring)

Signal evaluation of up to 2 independent single-channel switches/sensors with individually switched sensor power supply via T0, T2, T4, T6 and with shared clock signal via T1, T3, T5, T7.



This function mode detects short circuits and cross-circuiting in the sensor wiring.

Example A

2 single-channel switches/sensors (NO or NC)

Circuit diagram	Channel pair ports			
	T0	T2	T4	T6
	E1	E3	E5	E7
	0 V			
	E0	E2	E4	E6
	T1	T3	T5	T7

Tab. 1/16: Function mode 3 – 1oo1 T (example A)



Note

Safety-related evaluation only with the following connection blocks:

- CPX-M-AB-4-M12X2-5POL-T
- CPX-AB-8-KL-4POL.

Example B

2 single-channel safety sensors with test input

Circuit diagram	Channel pair ports			
	24 V	24 V	24 V	24 V
	T0	T2	T4	T6
	E1	E3	E5	E7
	0 V			
	E0	E2	E4	E6
	T1	T3	T5	T7

Tab. 1/17: Function mode 3 – 1oo1 T (example B)



Note

safety-related evaluation only with the following connection block:

- CPX-AB-8-KL-4POL.



On this connection block 8 single-channel safety sensors can be connected.

Functional safety for both examples

- PL c, Cat. 1 / SIL 1
with switch/sensor operationally tried and tested in accordance with EN 13849-2, Table D.3
- **up to** PL c, Cat. 3 / SIL 2
with certified switch/sensor of an appropriate safety category
and with wiring protection of the customer application in accordance with EN 13849-2, Table D.4,
and with testing of the safety application once a year

1. System overview CPX-F8DE-P

- **up to** PL e, Cat. 3 / SIL 3
with certified sensor and appropriate safety category
and with wiring monitoring through the connected sensor (example B).

Function mode 4 – 1oo1 D (antivalent)

Signal evaluation of up to 2 independent two-channel switches/sensors (NO or NC) or up to 4 operationally tried and tested switches per channel pair.

For E1, E3, E5 and E7, the clock signals are wired as a mirror image of E0, E2, E4 and E6

Circuit diagrams	Channel pair ports			
	T0	T2	T4	T6
	E1	E3	E5	E7
	0 V			
	E0	E2	E4	E6
	T1	T3	T5	T7
	T0	T2	T4	T6
	E1	E3	E5	E7
	0 V			
	E0	E2	E4	E6
	T1	T3	T5	T7

Tab. 1/18: Function mode 4 – 1oo1 D



This function mode tests the switch function and wiring of the sensors.

- Only use sensors with antivalent outputs on which one contact opens before the other contact closes.

1. System overview CPX-F8DE-P

- Ensure that the NO and/or NC switch on sensors with the appropriate clock signal connections for the channel pair are connected up → Circuit diagram.
- Note that before every actuation, a zero crossing is required (standby contact of the NC switch closed).



Note

Safety-related evaluation only with the following connection blocks:

- CPX-M-AB-4-M12X2-5POL-T
- CPX-AB-8-KL-4POL.

Functional safety

- PL e, Cat. 3 / SIL 3
with 2 independent switches/sensors operationally tested in accordance with EN 13849-2, Table D.3, these switches / sensors are to be realized as independent systems in the customer application
- **up to** PL e, Cat. 3 / SIL 3
with certified switch/sensor of a suitable safety category.

1. System overview CPX-F8DE-P

Function mode 5 – 1oo2 (equivalent)

Signal evaluation of a sensor (typically OSSD) that switches both signals of a channel pair simultaneously.

The sensor can monitor for short circuits and for cross-circuiting.

Example A

A two-channel sensor (internally equivalent) per channel pair with standard unswitched sensor power supply. T0, T2, T4, T6 run in this function mode on static 24 V DC.

Circuit diagram	Channel pair ports			
	T0/24 V	T2/24 V	T4/24 V	T6/24 V
	E1	E3	E5	E7
	0 V			
	E0	E2	E4	E6
	T1/FE	T3/FE	T5/FE	T7/FE

Tab. 1/19: Function mode 5 – 1oo2 (example A)

Example B

OSSD sensor

Circuit diagram	Channel pair ports			
	24 V	24 V	24 V	24 V
	E1	E3	E5	E7
	0 V			
	E0	E2	E4	E6
	T1/FE	T3/FE	T5/FE	T7/FE
	FE contact of sensor via the M12 connector screw connection on the module			

Tab. 1/20: Function mode 5 – 1oo2 (example B)



Note

Malfunction when using OSSD sensors on the connection block CPX-M-AB-4-M12X2-5POL-T.

The connection of an FE contact to pin 5 of an M12 socket will result in a short circuit. This would result in a malfunctioning of the signals T1, T3, T5 and T7.

The input module reports module fault 2: "Short circuit".

- Connect the FE contact of a sensor only to the M12 plug connector fitting of the module.

Functional safety

- **up to** PL d, Cat. 2 / SIL 2
with certified switch/sensor of an appropriate safety category
and with automatic testing of the safety function by the machine within 24 hours
- **up to** PL d, Cat. 2 / SIL 3
with certified switch/sensor of an appropriate safety category
and with wiring protection of the customer application in accordance with EN 13849-2, Table D.4,
and with automatic testing of the safety function by the machine within 24 hours
- **up to** PL e, Cat. 4 / SIL 3
with certified sensor (OSSD) and appropriate safety category
and with wiring monitoring through the connected sensor (example B).

1. System overview CPX-F8DE-P

Function mode 6 – 1oo2 T (equivalent, with clock signal monitoring)

Signal evaluation of a two-channel switch/sensor (internal equivalent) per channel pair with individually switched power supply.

Circuit diagram	Channel pair ports			
		T0	T2	T4
E1		E3	E5	E7
0 V				
E0		E2	E4	E6
T1		T3	T5	T7

Tab. 1/21: Function mode 6 – 1oo2T



This function mode detects short circuits and cross-circuiting in the sensor wiring.

This function mode is especially well suited to applications that expect fast reactions (e.g. emergency stop, certified switches/sensors).



Note

Safety-related evaluation only with the following connection blocks:

- CPX-M-AB-4-M12X2-5POL-T
- CPX-AB-8-KL-4POL.

Functional safety

- **up to** PL e, Cat. 3 / SIL 2
with certified switch/sensor of suitable safety category

1. System overview CPX-F8DE-P

- **up to** PL e, Cat. 4 / SIL 3
with certified switch/sensor of an appropriate safety category
and with automatic testing of the safety function by a machine within 24 hours
- **up to** PL e, Cat. 4 / SIL 3
with certified switch/sensor of an appropriate safety category
and with wiring protection of the customer application in accordance with EN 13849-2, Table D.4.

Function mode 7 – 1oo2 D (two-hand control device of type IIC in accordance with EN 574)

Signal evaluation of up to 2 dependent two-channel switches/sensors per channel pair, with temporal monitoring of signal change.

For E1, E3, E5 and E7, the clock signals are wired as a mirror image of E0, E2, E4 and E6

Actuation of both buttons within 500 ms generates a logical 1 in the input image of the channel pair.

Note that before every actuation, a zero crossing is required (both NC standby contacts closed).

Circuit diagram	Channel pair ports			
	T0	T2	T4	T6
	E1	E3	E5	E7
	0 V			
	E0	E2	E4	E6
	T1	T3	T5	T7

Tab. 1/22: Function mode 7 – 1oo2 D

1. System overview CPX-F8DE-P

- Only use sensors with antivalent outputs on which one contact opens before the other contact closes.
- Ensure that the NO and/or NC switch on sensors with the appropriate clock signal connections for the channel pair are connected up → Circuit diagram.



Note

Safety-related evaluation only with the following connection blocks:

- CPX-M-AB-4-M12X2-5POL-T
- CPX-AB-8-KL-4POL.

Functional safety

- PL e, Cat. 4 / SIL 3
with 2 switches/sensors, wiring and safety function in accordance with EN 574 type IIIC.

Function mode 8 – 1oo2 T (equivalent, with clock signal monitoring, robust)

Signal evaluation of mechanical contacts on a two-channel switch/sensor (internal equivalent) or of 2 independent, tried and tested switches.

Circuit diagram	Channel pair ports			
	T0	T2	T4	T6
	E1	E3	E5	E7
	0 V			
	E0	E2	E4	E6
	T1	T3	T5	T7

Tab. 1/23: Function mode 8 – 1oo2 T (robust)



This function mode corresponds to function mode 6, but due to an extended evaluation time it is not affected by contact bouncing.

The function mode is therefore unsuitable for applications that expect fast reactions (e.g. air grids).

- Note the extended reaction time.
- Only use this function mode when intended to have a maximum request rate of 1 per 60 seconds.



Note

Safety-related evaluation only with the following connection blocks:

- CPX-M-AB-4-M12X2-5POL-T
- CPX-AB-8-KL-4POL.

Functional safety

- **up to** PL e, Cat. 3 / SIL 2
with certified switch/sensor of an appropriate safety category or 2 independent, tried and tested switches in accordance with EN 13849-2, Table D.3
- **up to** PL e, Cat. 4 / SIL 3
with certified switch/sensor of an appropriate safety category or 2 independent, tried and tested switches in accordance with EN 13849-2, Table D.3,
and with automatic testing of the safety function by the machine within 24 hours
- **up to** PL e, Cat. 4 / SIL 3
with certified switch/sensor of an appropriate safety category or 2 independent, tried and tested switches in accordance with EN 13849-2, Table D.3,
and with wiring protection of the customer application in accordance with EN 13849-2, Table D.4.

Function mode 9 – 1 of N (one off N)

Evaluation of one of a maximum of 8 signals with monitoring of the signal change over time, e.g. Mode selector switch. The input image is switched 100 ms after actuation.

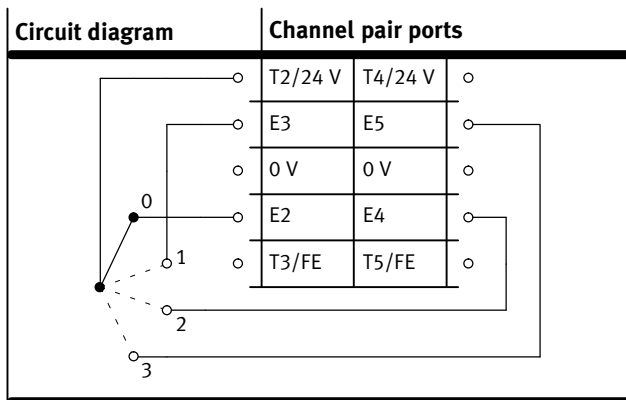

Tab. 1/24: Function mode 9 – 1 of N (one of N)

This function mode serves to evaluate an operating mode switch or a rotary indexing table.

- For channel bundling, only use consecutive channel pairs.
- Enable this function mode for all channel pairs used. Variants: 1 of 2, 1 of 4, 1 of 6 or 1 of 8.

The circuit diagram (→ Tab. 1/24) shows, by way of example, variant “1 of 4”. The directly consecutive channel pairs E2/E3 and E4/E5 are used, both of which must be configured to function mode 9. The power supply can either be switched from T2 or 24 V to one of inputs E2, E3, E4, E5.



This is required for this example: channel pairs E0/E1 and E6/E7 are **not** configured to function mode 9.

Functional safety

- PL c, Cat. 1 / SIL 2
with tried and tested switches/sensors in accordance with EN 13849-2, Table D.3
- **up to** PL e, Cat. 3 / SIL 3
with certified switches/sensors of an appropriate safety category.

Several channel pairs in function mode 9



Note

For the evaluation of more than two signals in a circuit:

- Use directly consecutive channel pairs.

When configuring two independent “1 of N” circuits on one input module:

- Ensure that the channel pairs used for the different circuits are **not** directly consecutive to one another.

In the next section, you will find all the permitted configurations for setting function mode 9 on several channel pairs.

Channel pair	E0 E1	E2 E3	E4 E5	E6 E7
“1 of 4” circuits	Mode 9	Mode 9		
		Mode 9	Mode 9	
			Mode 9	Mode 9
“1 of 4” and “1 of 2” circuits	Mode 9		Mode 9	Mode 9
	Mode 9	Mode 9		Mode 9
“1 of 6” switching circuits	Mode 9	Mode 9	Mode 9	
		Mode 9	Mode 9	Mode 9
“1 of 8” circuits	Mode 9	Mode 9	Mode 9	Mode 9
Two independent “1 of 2” circuits	Mode 9		Mode 9	
		Mode 9		Mode 9
	Mode 9			Mode 9

Tab. 1/25: Function mode 9 for up to 2 circuits

- Set the other channel pairs to any function mode except for mode 9.

Function mode 10 – coded identifier

Evaluation of a coded identifier by DIL switch in connection block CPX-AB-ID-P.



Prerequisite for use of a coded identifier:

All channel pairs are set via the output image to function mode 10.

8-element DIL switch	Switches	Value	Inlet
	8	Parity bit	E7
	7	64	E5
	6	32	E3
	5	16	E1
	4	8	E6
	3	4	E4
	2	2	E2
	1	1	E0

Tab. 1/26: Function mode 10 – coded identifier

Setting a coded identifier

1. With switches 1 to 7, set the desired identifier. Only use values 1 to 126.
2. If you have an odd number of switches 1 to 7 set to ON: Also set parity bit (switch 8) to ON.

Input image

The input image always outputs a 0 instead of the parity bit, to enable the set identifier to be used directly in the safety controller.

Functional safety

- PL e, Cat. 3 / SIL 3
with certified switch of an appropriate safety category or independent, tried and tested switches in accordance with EN 13849-2, Table D.3,
and with protection of the application against simple manipulation.

The connection block CPX-AB-ID-P meets these requirements regarding functional safety without any supplementary measures.

1.3.4 Use of switching signals

Clock signals are used to monitor the wiring on the input channels of the input module.

Via T0, T2, T4 and T6 specific switching signals are made available for the relevant input channel:

- To detect cross-circuiting between inputs and clock signal connections for function modes with switching signals or diagnostics
- To detect short circuits between the inputs/clock signal connections and sensor wiring.



On function modes with switching signals:

- Clock output signals T1, T3, T5 and T7 have the same clock signal signal.
- Clock output signals T0, T2, T4 and T6 run different switching signals to one another, and in respect of T1/T3/T5/T7.



Note

OSSD sensors on connection block CPX-M-AB-4-M12X2-5POL-T will cause a fault to occur.

The connection of an FE contact to Pin 5 on an M12 socket causes a short circuit. This adversely affects signals T1, T3, T5, T7.

The input module reports module fault 02: “Short circuit 0 V at clock signal output T1357”.

- Only connect the FE contact of a sensor to the M12 connector screw connection of the module.

1.3.5 Channel bundling

Depending on the function mode use, 2, 4, 6 or 8 channels can be grouped together to form a channel bundle.

Within a channel bundle, the input and qualification bits behave as follows:

Status of the inputs	Input bits	Qualification bits on the channel bundle
No error	0 or 1 (dependent upon function mode and input signal)	1
Faults	0	0

Tab. 1/27: Behaviour of input data with channel bundles



If channel-wise passivation is not enabled, when a fault is detected, all input data bits are set to 0.

1.4 Application examples

The creation of a safety function involves secure evaluation of connected sensors. The following examples of applications in conjunction with 11 set function modes (→ Chapter 1.3.3) show you the different potential options for the intended use of the CPX-F8DE-P.

1.4.1 Control console

This sample applications shows the possible utilization of all channel pairs on an input module.

For a typical operating panel, the following sensors can be evaluated in a safety-related manner:

- Two-handed circuit for starting a function
- Emergency stop switch for incidents
- Operating mode switch with 4 positions.

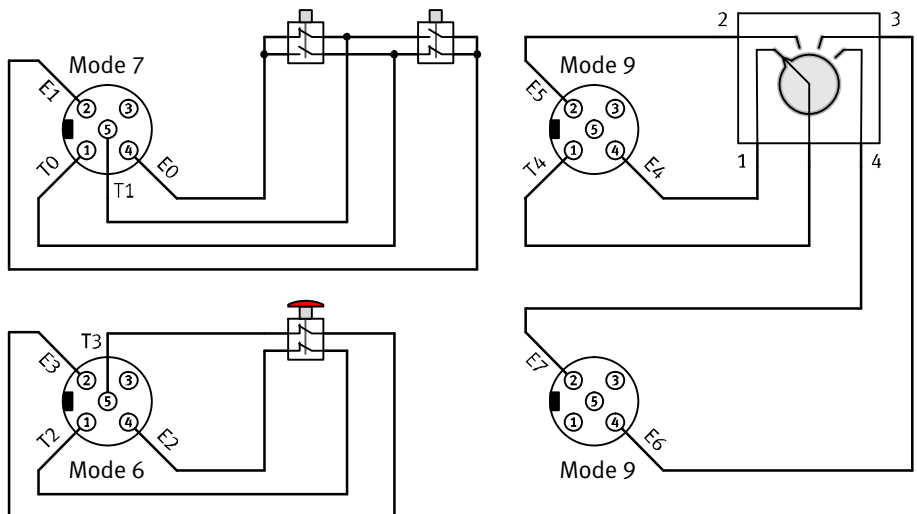

Fig. 1/4: Maximum configuration

1. System overview CPX-F8DE-P

Fig. 1/4 shows the circuitry of channel pairs with permitted sensors → Tab. 1/12. This involves the channel pairs being set with the following function modes:

Channel pair	Mode	Comment
E0/E1	7	Evaluation of the two-handed circuit
E2/E3	6	Evaluation of the emergency stop button
E4/E5	9	Evaluation of an operating mode switch
E6/E7	9	



Note

The safety-related evaluation in this example is only possible on the following connection blocks:

- CPX-M-AB-4-M12X2-5POL-T
- CPX-AB-8-KL-4POL.

1. System overview CPX-F8DE-P

1.4.2 rotary indexing table

This sample application shows the possible use of 2 channel pairs for 4 positions on a rotary indexing table. It involves the use of 4 NC switches that alternately signal the rotary position of the rotary indexing table.

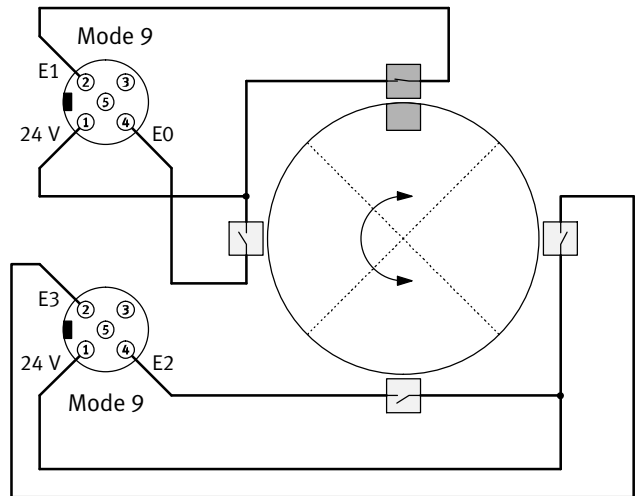

Fig. 1/5: Rotary indexing table with 4 rotary positions

The other channel pairs on the input module can be used to evaluate other sensors on a loading and an unloading station.

When connecting up the sensors (e.g. B. SMT-8M-A) it is advisable to use pre-assembled Y cables from the NEBU modular cable system → www.festo.com/catalogue.

1. System overview CPX-F8DE-P

Fig. 1/5 shows the circuitry of channel pairs with independent sensors. This involves the channel pairs being set with the following function modes:

Channel pair	Mode	Comment
E0/E1	9	Evaluation of 4 positions of the rotary indexing table.
E2/E3	9	



This sample application can also be implemented using electronic sensors (2-wire or 3-wire) sensors.

1.4.3 Limit position switch

In this sample application, piston positions are evaluated with 2 two-channel sensors with mechanical contacts (internally antivalent, NO/NC) via a channel pair on the input module.

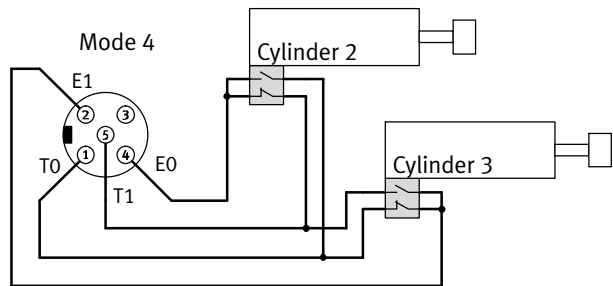

Fig. 1/6: Evaluation of limit position switches



Note

Faults are possible.

- For this function mode, **do not** use electronic sensors with standby diode on a shared sensor output.

Alternatively: Electronic 3-wire sensors with polarity reversal protection in positive power supply connection.



Note

Safety-related evaluation only with the following connection blocks:

- CPX-M-AB-4-M12X2-5POL-T
- CPX-AB-8-KL-4POL.



Antivalency is evaluated in order to diagnose the sensor wiring. Reaching the limit position is output as a secured logical information in the PAE (input image).

1. System overview CPX-F8DE-P

1.4.4 Light curtain

This sample application shows the connection of transmitter and receiver of a light grid via a channel pair on the input module.

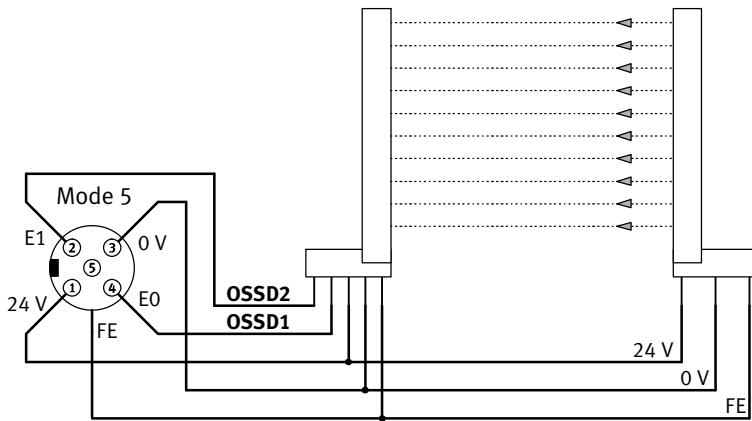

Fig. 1/7: Connection of a light grid

Channel pair	Mode	Comment
E0/E1	5	Signal evaluation of a sensor (typically OSSD)

Depending on the connection block used, the permitted current consumption per connection may vary:

- CPX-M-AB-4-M12X2-5POL up to 2 A
- CPX-M-AB-4-M12X2-5POL-T up to 0.7 A.



When wiring in a switch cabinet, the input module can also be operated with connection block CPX-AB-8-KL-4POL. All signals are available there without any restriction.

1. System overview CPX-F8DE-P

1.4.5 Acknowledge button with request

This sample application shows the circuitry of a button with a light signal. Actuation of this button can only be evaluated while clock signal connection T0 of a channel pair is connected to a 24V power source. At the same time, the LED on the button lights up to indicate the possible evaluation of this actuation.

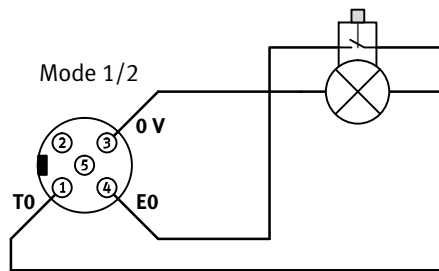

This circuit only functions by a changeover between function modes 1 and 2 in the safety program.



Note

The safety-related evaluation in this example is only possible on the following connection blocks:

- CPX-M-AB-4-M12X2-5POL-T
- CPX-AB-8-KL-4POL.



When using the connection block CPX-AB-8-KL-4POL (connection technology “CageClamp”) another sensor/switch can be connected to the channel pair used via terminals 24V and E1.

1. System overview CPX-F8DE-P

1.4.6 2 two-wire sensors

This sample application shows the circuitry of 2 electronic two-wire sensors on one channel pair.

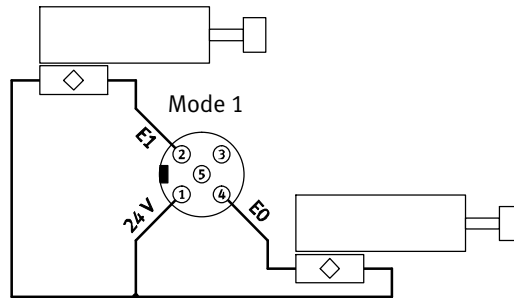

Fig. 1/8: 2 electronic two-wire sensors



The input module CPX-F8DE-P has Digital Inputs Type 2 in accordance with IEC 61131-2. This makes it possible to use up to 8 electronic two-wire sensors.

1.4.7 2 protective doors on one channel pair

This sample application shows the circuitry of two protective doors on one channel pair.

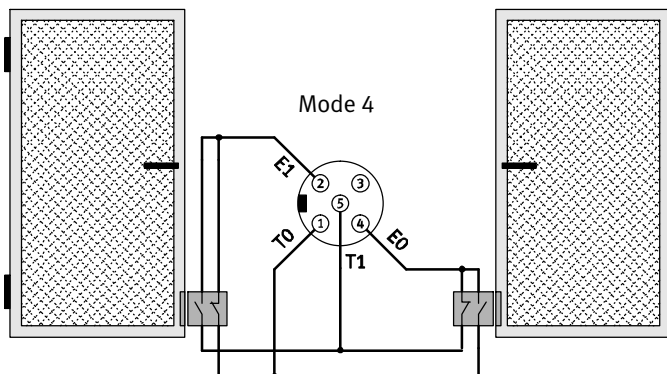

Fig. 1/9: 2 protective door sensors on one channel pair

1.4.8 Protective door with two NO switches

This sample application is suitable for settings with vibrations, e.g. close to a press or stamping machine.

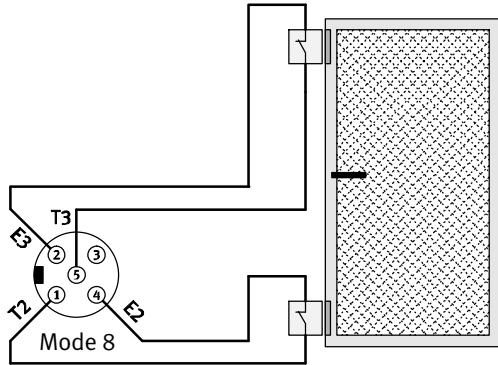

Fig. 1/10: 2 NO switches on one channel pair



With function mode 8, a robust version of the safety circuit is implemented. This safety function is enabled only if both switches are closed within 60 seconds of one another. If a switch was not previously opened, the channel or module is passivated. The input module reports channel error 55: “Process value”.

1. System overview CPX-F8DE-P

Installation

Chapter 2

2. Installation

Contents

2.	Installation	2-1
2.1	General instructions on installation	2-3
2.1.1	Module-related rules for configuration	2-4
2.2	Electrical connection and display components	2-5
2.2.1	Pin allocation on connection block CPX-M-AB-4-M12X2-5POL-T	2-6
2.2.2	Pin allocation on connection block CPX-M-AB-4-M12X2-5POL	2-7
2.2.3	Pin allocation on connection block CPX-AB-8-KL-4POL	2-8
2.3	Installation of the electronic module	2-9
2.3.1	Dismantling the electronics module	2-10
2.3.2	Mounting the electronics module	2-10
2.4	Set PROFIsafe address	2-11
2.5	Connection of sensors	2-13
2.5.1	Ensuring the protection class	2-14

2. Installation

2.1 General instructions on installation



Warning

Electrical voltage

Injury caused by electric shock, damage to machine and to system.

- For the electrical power supply, only use PELV power circuits in accordance with IEC 60204-1 (Protective Extra-Low Voltage, PELV).
- Note the general requirements of IEC 60204-1 in respect of PELV-power circuits.
- Use only voltage sources that guarantee a reliable electric disconnection of operating and load voltage in accordance with IEC 60204-1.
- Always connect all of the power circuits for operating and load voltage supplies $U_{EL/SEN}$, U_{VAL} and U_{OUT} .

Through the use of PELV circuits, protection from electric shock (protection from direct and indirect contact) in accordance with IEC 60204-1 is ensured (refer to Electrical Equipment of Machines. General Requirements).

2. Installation

2.1.1 Module-related rules for configuration

- Plug input module CPX-F8DE-P into one of the following interconnecting blocks, only:
 - CPX-M-GE-EV
 - CPX-M-GE-EV-S-7/8-5POL
 - CPX-M-GE-EV-S-7/8-CIP-4P
 - CPX-M-GE-EV-S-PP-5POL
 - CPX-M-GE-EV-Z-7/8-5POL
 - CPX-M-GE-EV-Z-PP-5POL.
- Only operate input module with one of the following connection blocks:
 - CPX-M-AB-4-M12X2- 5PIN-T
 - CPX-M-AB-4-M12X2- 5POL
 - CPX-AB-8-KL-4POL
 - CPX-AB-ID-P.
- Only use input module in conjunction with permitted product versions of the CPX terminal → Chapter 1.1.3.

2. Installation

2.2 Electrical connection and display components

The LEDs and the module identification can be seen through the transparent cover of the connection block.

- 1 Product label on connection and interconnecting block
- 2 Status LED (green); one on each input channel
- 3 Channel error LED (red); one per input channel
- 4 Module error LED (red)
- 5 FP-LED (green) - Failsafe Protocol
- 6 Module identifier F8DIP (for CPX-F8DE-P)
- 7 Area for electrical connections (here CPX-AB-8-KL-4POL)

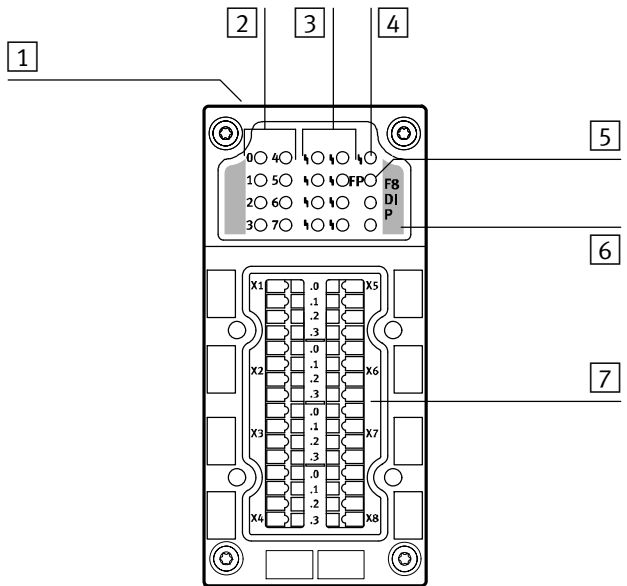

Fig. 2/1: Display and connecting elements CPX-F8DE-P



Detailed information about the LEDs → Chapter 5.3.

2. Installation

2.2.1 Pin allocation on connection block CPX-M-AB-4-M12X2-5POL-T

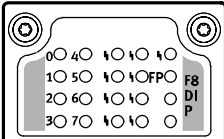
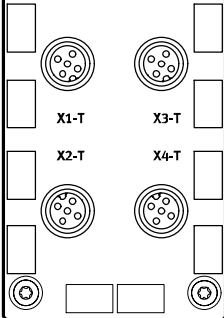
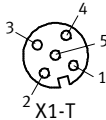
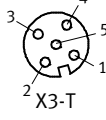
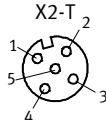
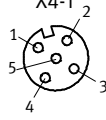
CPX-F8DE-P with connection block CPX-M-AB-4-M12X2-5POL-T				
Connection block	Pin allocation X1-T, X2-T		Pin allocation X3-T, X4-T	
 	 <p>Socket X1-T</p> <ol style="list-style-type: none"> 1: T0 2: E1 3: 0 V 4: E0 5: T1¹⁾ 	 <p>Socket X3-T</p> <ol style="list-style-type: none"> 1: T4 2: E5 3: 0 V 4: E4 5: T5¹⁾ 	 <p>Socket X2-T</p> <ol style="list-style-type: none"> 1: T2 2: E3 3: 0 V 4: E2 5: T3¹⁾ 	 <p>Socket X4-T</p> <ol style="list-style-type: none"> 1: T6 2: E7 3: 0 V 4: E6 5: T7¹⁾
<p>¹⁾ For this connection technology, never connect Function Earth (FE) to Pin 5. The metal thread on the connection block can be used as the function earth for connected sensors.</p>				

Tab. 2/1: Pin allocation with M12 connection block CPX-M-AB-4-M12X2-5POL-T

2. Installation

2.2.2 Pin allocation on connection block CPX-M-AB-4-M12X2-5POL

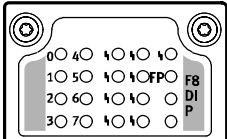
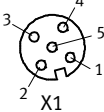
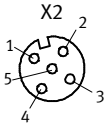
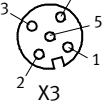
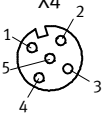
CPX-F8DE-P with connection block CPX-M-AB-4-M12X2-5POL			
Connection block	Pin allocation X1, X2		Pin allocation X3, X4
  	<p>Socket X1</p> <ul style="list-style-type: none"> 1: 24 V 2: E1 3: 0 V 4: E0 5: FE <p>Socket X2</p> <ul style="list-style-type: none"> 1: 24 V 2: E3 3: 0 V 4: E2 5: FE 	 	<p>Socket X3</p> <ul style="list-style-type: none"> 1: 24 V 2: E5 3: 0 V 4: E4 5: FE <p>Socket X4</p> <ul style="list-style-type: none"> 1: 24 V 2: E7 3: 0 V 4: E6 5: FE
<p>FE = functional earth n.c. = free (not connected)</p>			

Tab. 2/2: Pin allocation with M12 connection block CPX-M-AB-4-M12X2-5POL



The metal threads of the connection block CPX-M-AB-4-M12X2-5POL are connected internally to pin 5 (function earth FE).

2.3 Installation of the electronic module



Note

Incorrect handling can cause damage to the electronics modules.

- Never push/pull the electronics module into/out of the interlinking block when powered.

Electronic modules include electrostatically sensitive devices.

- Observe the handling specifications for electrostatically sensitive devices.
- Discharge yourself electrostatically before assembling or disassembling modules to protect the modules.

Before the CPX terminal can be extended or converted, it must first be unscrewed and dismantled. Instructions on this can be found in the CPX system description.

CPX terminals are supplied from the factory completely fitted. It may be necessary to fit or remove the connection blocks for the following reasons:

- Replacement of the connection block
- Changing the DIL switch setting → Chapter 2.4, on setting the PROFIsafe address
- replacement of a defective electronics module.

The plugs connected to the connection block may remain attached whilst dismantling the connection block.

2. Installation

2.3.1 Dismantling the electronics module

1. Switch off operating and load voltage supplies to the CPX terminal.
2. Unscrew and remove mounting screws **10** → Fig. 1/1.
3. Carefully lift off connection block **1**, **2** or **3**.
4. If required, carefully remove electronic module **4** from the bus bars.

2.3.2 Mounting the electronics module

- Ensure prior to assembly that the PROFIsafe address on the electronic modules is set correctly → Chapter 2.4.



Note

- Handle the components with care.
- Ensure that the interconnecting block is clean and free of foreign bodies, especially on and near the contact rails.
- Check the seal and the sealing surfaces. Replace damaged parts.
- Ensure that connecting surfaces are clean. This helps to optimise the sealing action and to prevent contact faults.

1. Position input module correctly in interconnecting block **6** without tilting it and press it to the stop → Fig. 1/1.
2. Align connection block **1**, **2** or **3** and fit to electronic module **4**.
3. Screw the mounting screws **10** into the existing threads.
4. Screw the mounting screws crosswise.
Tightening torque: 0.9 ... 1.1 Nm.

2. Installation

2.4 Set PROFIsafe address

The input module is controlled by an F-Host via PROFIsafe and needs a PROFIsafe address for the F-host to identify itself uniquely. The PROFIsafe address is defined by configuration software and is set using binary coding on the 10-bit DIL switch. Both settings must match.

Permitted PROFIsafe addresses: 1 ... 1022

The 10-bit DIL switch is located directly on the electronics module and can be set while the connection block is not mounted → Fig. 1/1.



The DIL switch setting is evaluated during the start phase of the firmware.

1. Set the DIL-switch carefully using a small screwdriver.
2. Switch the input module back on to use a new address.

Information on address allocation by configuration software can be found in the documentation of the software used.

The PROFIsafe address 0 is preset at the factory.

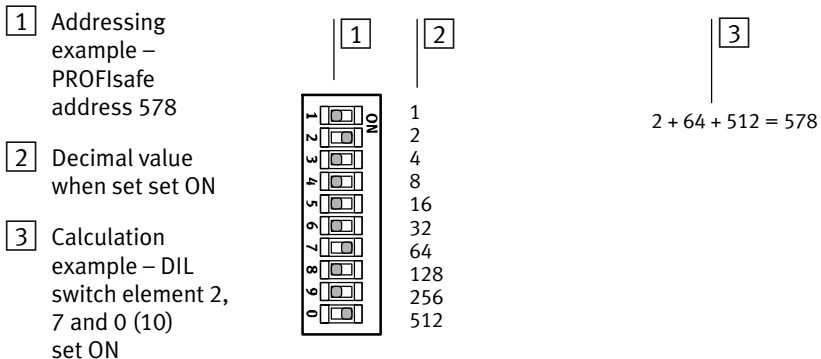

Fig. 2/2: 10-bit DIL switch for setting the PROFIsafe address – binary coded

2. Installation



Note

Malfunctions

- Prior to commissioning of the automated system:
Set PROFIsafe-address in accordance with installation planning and applicable allocation rules.



Note

Incorrect handling can result in damage to the electronics module.

- Switch off operating and load voltage supplies before any assembly and installation work.
- Do not switch on the operating and load voltage supplies until the product has been mounted completely and all installation work has been completed.

Procedure:

1. Switch off operating and load voltage supplies to the CPX terminal.
2. Remove the connection block → Chapter 2.3.1.
3. Set PROFIsafe address on binary coded 10-bit DIL switch → Fig. 2/2.
Permitted PROFIsafe addresses: 1 ... 1022
4. Reinstall the connection block → Chapter 2.3.2.
5. Switch input module back on.

2.5 Connection of sensors

**Note**

Incorrect handling can result in damage to the electronics module.

- Switch off operating and load voltage supplies before any assembly and installation work.
- Do not switch on the operating and load voltage supplies until the product has been mounted completely and all installation work has been completed.

The sensors for the input module are connected to the connection block. This means, for example when replacing the electronic module, that the connectors and cables stay on the connection block.

Maximum permitted cable lengths to the sensors
(→ Appendix A.1, Tab. A/2).

Festo plug connector(s) (→ www.festo.com/catalogue).

**Note**

Cross circuit monitoring of sensor wiring depends on the function mode being used (→ Chapter 1.3.3).

- Ensure that cross circuits in power circuits with voltages above the maximum input voltage are not possible using appropriate installation measures.

2. Installation

2.5.1 Ensuring the protection class

The type of protection on the input module depends on the connection block being used (→ Appendix A.2) and on the plug connectors, cover caps and covers being used.

- Always ensure that the connection technology being used has the required protection classification.
- Use cover caps to seal unused M12 connections.
- Close terminal strip of connection block CPX-AB-8-KL-4POL with cover AK-8KL.

Accessories → www.festo.com/catalogue

Commissioning

Chapter 3

Contents

3.	Commissioning	3-1
3.1	General instructions	3-3
3.2	Device master file (GSDML and GSD)	3-4
3.3	Module identifiers	3-4
3.4	Preparing for commissioning	3-5
3.5	Commissioning steps	3-6
3.6	Set the PROFI-safe parameters	3-7
3.7	Interrogation of the CPX module parameters	3-9
3.7.1	Parameter and signal display with the operator unit CPX-MMI-1 ..	3-11
3.8	Configuration with Siemens STEP 7 (example).	3-13
3.8.1	Addressing example	3-16

3. Commissioning

3.1 General instructions

Operation of the input module is only possible with the following bus node, core device files and the following control unit software:

bus node	Device master file	Controller software
<ul style="list-style-type: none">– CPX-FB13 Rev. 30¹⁾ and higher– CPX-FB33 Rev. 21¹⁾ and higher– CPX-M-FB34 Rev. 21¹⁾ and higher– CPX-M-FB35 Rev. 21¹⁾ and higher	<ul style="list-style-type: none">– PROFIBUS: CPXe059E.gsd dated 17.03.2014 and higher– PROFINET IO: GSDML-V2.31-Festo-CPX-20141203.xml dated 03.12.2014 and higher	Compatible with device PROFIsafe V2 (Version 2.4)
¹⁾ Revision code → Product nomenclature bus node		

Tab. 3/1: Required versions

The configuration is dependent on the control system used. The basic approach and required configuration data are presented in the following pages.

3. Commissioning

3.2 Device master file (GSDML and GSD)

In conjunction with the input module CPX-F8DE-P you need a current GSDML/GSD device master file for configuration and programming.

Reference source

Current versions of the GSDML/GSD-files for CPX terminals can be found on the Festo website → www.festo.com/sp.

After importing the GSDML/GSD-file into the project of the F-Host configuration program you can select and edit the CPX terminal using the input module CPX-F8DE-P in the configuration program.



Configuration, parametrisation and commissioning of the CPX terminal with CPX-F8DE-P are dependent on the control system used.

You will find detailed information in the documentation of the control system used and the online help of the configuration software.

3.3 Module identifiers

Each module has its own identifier (module identifier).

- Adopt the module identifiers – as in the CPX terminal arranged from left to right – into your configuration program.

Module (order code)	Module indicator ¹⁾	Assigned I/O bytes ²⁾
CPX-F8DE-P	F8DI-P	6 byte I + 7 byte O
¹⁾ Module identifier in the operator unit ²⁾ Four bytes each are used exclusively for PROFIsafe communication		

Tab. 3/2: Module identifiers on the input module CPX-F8DE-P

3. Commissioning

3.4 Preparing for commissioning

1. Ensure that the CPX terminal is mounted correctly → CPX system description.
2. Check the wiring (connection cables, contact allocation) → Chapter 2.2.1.
3. Dismantle the connection block on the input module → Chapter 2.3.1.
4. Check that the input module functions perfectly.
5. Set the PROFIsafe address on the input module using the DIL switch and install the connection block → Chapter 2.3.2.

3.5 Commissioning steps



Detailed information on configuration, programming and commissioning in combination with the F-Host used can be found in the documentation of the F-Host manufacturer. You can find notes on the configuration and commissioning of the CPX terminal in the description of the bus node.

1. Integrate the GSDML/GSD file in the configuration software of the F-Host → Description of the bus node.
2. Configure and parameterize the CPX terminal including the input module with the configuration software of the F-Host.
 - Integrate CPX terminal in the configuration → Description of the bus node
 - If necessary: Set the starting addresses for inputs and outputs
 - Set standard parameters on the input module
 - Set PROFIsafe parameters on the input module → Chapter 3.6.
3. Create and load a backup program.
4. Commission CPX terminal on field bus (PROFIBUS or PROFINET IO) and validate its behaviour in a test run.

3.6 Set the PROFIsafe parameters

PROFIsafe-specific parameters can be viewed or set with the configurator of the F-Host (e.g. HW Config). These are designated after the PROFIsafe profile in the GSDML/GSD file. As a result, access is possible only after the password is entered in the F-Host.



The function mode is set via the output data on the process image → Chapter 1.2.3.

PROFIsafe parameters	General description	For CPX-F8DE-P, the following apply:	Value
F_Check_iPar	Establishes whether the individual device parameters (CPX module parameter) should be taken into account in the consistency check (CRC calculation) of the F-user data telegram.	– CPX-F8DE-P makes no individual device parameters available.	– No check (cannot be altered)
F_Check_SeqNo	Establishes whether the sequence number should be taken into account in the consistency check (CRC calculation) of the F-user data telegram.	– CPX-F8DE-P supports only the V2 mode. The sequence number is always incorporated in V2 mode in the CRC2 test.	– Check (not changeable)
F_SIL	Safety integrity level (SIL) which is expected by the module.	– CPX-F8DE-P supports the SIL 3 requirement.	– SIL 3
F_CRC_Length	Communicates the expected length of CRC2 key to the F-Host in the safety telegram.	– This parameter cannot be CPX-F8DE-P changed because the CRC2 key is always allocated 3 bytes.	– 3 -byte CRC (cannot be altered)
F_Block_ID	Shows if the data record for the value of F_iPar_CRC has been extended by 4 bytes. The parameter F_Block_ID has a value of 1 if the parameter F_iPar_CRC is present, otherwise it has a value of 0.	– CPX-F8DE-P makes no individual device parameters available.	– 0 (not changeable)

3. Commissioning

PROFIsafe parameters	General description	For CPX-F8DE-P, the following apply:	Value
F_Par_Version	Specifies the PROFIsafe operating mode of the device. The setting 1 corresponds to PROFIsafe V2-MODE.	– CPX-F8DE-P works exclusively in PROFIsafe V2-MODE.	– 1 (not changeable)
F_Source_Add (PROFIsafe source address)	Unique PROFIsafe source address of the F-Host.	– Unique PROFIsafe source address of the F-Host.	Specified through F-Host
F_Dest_Add (PROFIsafe target address)	Unique PROFIsafe target address of the F-Device within the PROFIsafe network. The target address set by the configuration software must match the PROFIsafe address set on the input module using the DIL switch.	– CPX-F8DE-P compares both settings to check the authenticity of the connection → Chapter 2.4.	– 1 ... 1022 (0 and 1023 are not permitted)
F_WD_Time	Time period (Watchdog Time) within which a valid current safety telegram must arrive from the F-Host. Otherwise, the F-Device goes into the safe status.	– The time period must be short enough that the system can react quickly enough to communication failures or malfunctions. On the other hand, the time period must be long enough to tolerate typical delays in transmission. The clock time for calling the safety program must be less than the time period set here.	– 50 ... 65535 [ms]
F_iPar_CRC	CRC through the individual device parameters (i-parameter).	– CPX-F8DE-P makes no individual device parameters available.	– 0 (not changeable)

Tab. 3/3: PROFIsafe parameters

3. Commissioning

3.7 Interrogation of the CPX module parameters



Further information on parameterization can be found in the CPX-system description P.BE-CPX-SYS-... or in the description of the bus node.

The following table provides an overview of the existing CPX module parameters on the input module.

Overview of module parameters CPX-F8DE-P			
Function number ¹⁾	Bit	Module parameter	Presetting
4828 + m * 64 + 1 ... 5	0 ... 7	Reserved	–
4828 + m * 64 + 8 ... 21	0 ... 7	Reserved for PROFIsafe	–
4828 + m * 64 + 22	0 ... 7	Position of 10x-DIL-switch for the PROFIsafe address of the module, bits 0 ... 7	0 ¹⁾
4828 + m * 64 + 23	0, 1	Position of 10x-DIL-switch for the PROFIsafe address of the module, bits 8 and 9 ...	0 ¹⁾
¹⁾ Parameters only readable through operator unit and command interpreter (CI).			

Tab. 3/4: Overview – module parameters CPX-F8DE-P

3. Commissioning

Module parameter: DIL switch setting		Operator unit																											
Function no.	4828 + m * 64 + 22 m = module number (0 ... 47) 4828 + m * 64 + 23																												
Description	Indicates the switch setting of the PROFIsafe address selector switch on the input module. In addition to the PROFIsafe parameter F_Dest_Add (→ Chapter 3.6) the setting of the address selector switch can be interrogated by CPX parameters for diagnostic purposes – e.g. with the operator unit (read only).																												
Bit	Low byte (4828 + m * 64 + 22) Bit 0: SW 0 Bit 1: SW 1 ... Bit 7: SW 7 High byte 4828 + m * 64 + 23) Bit 0: SW 8 Bit 1: SW 9 Bit 2 ... 7: reserved or 0	[PROFIsafe Addr]																											
Values	<table border="1"> <thead> <tr> <th>Bit 7</th> <th>Bit 6</th> <th>Bit 5</th> <th>Bit 4</th> <th>Bit 3</th> <th>Bit 2</th> <th>Bit 1</th> <th>Bit 0</th> <th></th> </tr> </thead> <tbody> <tr> <td>SW 7</td> <td>SW 6</td> <td>SW 5</td> <td>SW 4</td> <td>SW 3</td> <td>SW 2</td> <td>SW 1</td> <td>SW 0</td> <td>Lowbyte</td> </tr> <tr> <td>0</td> <td>0</td> <td>0</td> <td>0</td> <td>0</td> <td>0</td> <td>SW 9</td> <td>SW 8</td> <td>high byte</td> </tr> </tbody> </table>	Bit 7	Bit 6	Bit 5	Bit 4	Bit 3	Bit 2	Bit 1	Bit 0		SW 7	SW 6	SW 5	SW 4	SW 3	SW 2	SW 1	SW 0	Lowbyte	0	0	0	0	0	0	SW 9	SW 8	high byte	
	Bit 7	Bit 6	Bit 5	Bit 4	Bit 3	Bit 2	Bit 1	Bit 0																					
SW 7	SW 6	SW 5	SW 4	SW 3	SW 2	SW 1	SW 0	Lowbyte																					
0	0	0	0	0	0	SW 9	SW 8	high byte																					
	0: switch element is OFF 1: switch element is ON	[0] [1]																											
Comment	This parameter can only be changed by changing the DIL switch setting (read only).																												

Tab. 3/5: DIL switch setting

3. Commissioning

3.7.1 Parameter and signal display with the operator unit CPX-MMI-1

The universal operator unit CPX-MMI-1 offers convenient functions that support you during the commissioning process. With the operator unit, you can view the CPX module parameters and you can change them if necessary. The PROFIsafe parameters of the input module cannot be influenced using the operator unit. This is for technical safety reasons.



General information on the operator unit and about commissioning of the CPX terminal using the operator unit can be found in the description P.BE-CPX-MMI-1-... Knowledge of the basic functions of the operator unit are assumed in the following.

The main menu of the operator unit displays the name [F8DI-P Input Module Safety] for the input module. In the header on the operator unit, the short text message [F8DI-P] is displayed. An example is shown in the diagram below:

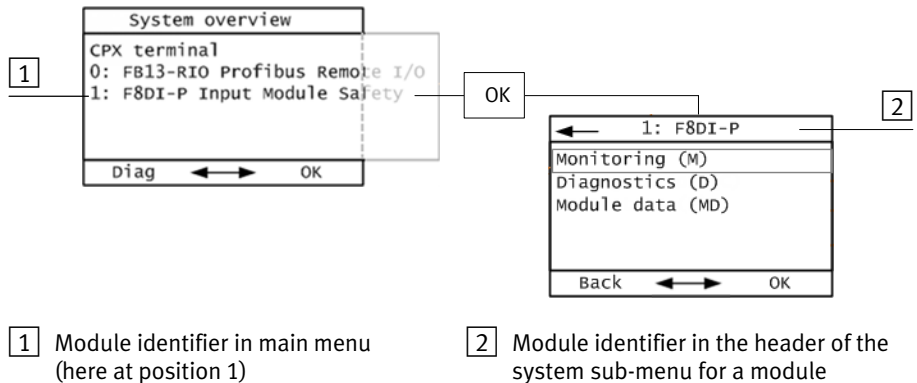
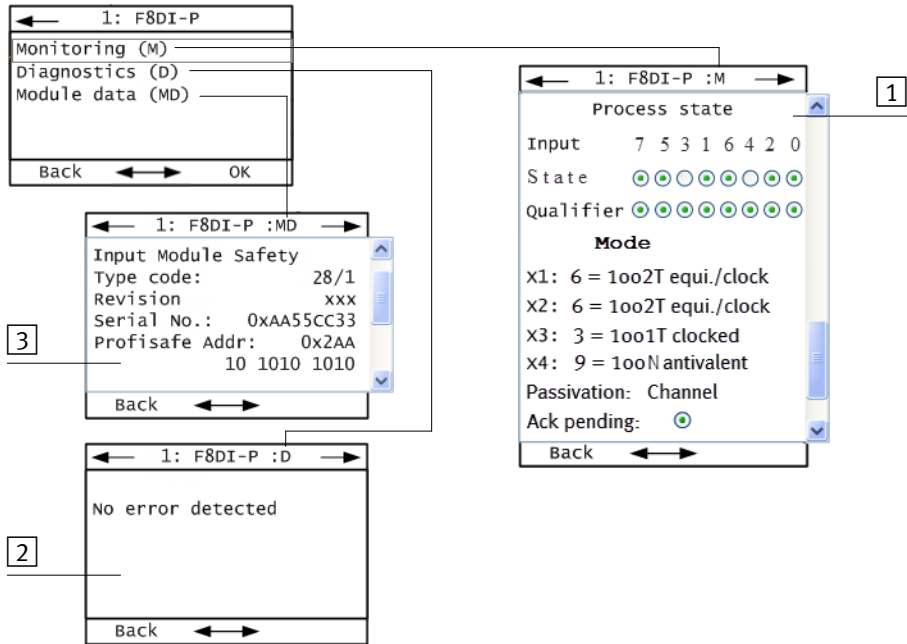

Fig. 3/1: Modul identifier of input module CPX-F8DE-P on operator unit

3. Commissioning

The following image shows, by way of example, the specific views for the input module CPX-F8DE-P.



1 Monitoring (M)

3 Module data (MD)

2 Diagnostics (D)

Fig. 3/2: Special representations for CPX-F8DE-P on the operator unit

When calling up the command [Monitoring (M)] the logical statuses of the 8 input channels and the related qualification bits (Qualifiers) are displayed in accordance with the set function modes. The display of input signals and qualification bits corresponds here to the PROFIsafe process image.

3.8 Configuration with Siemens STEP 7 (example).

The configuration examples shown in this chapter are based on the use of a Siemens programmable controller and the configuration and programming software Siemens STEP 7 Version 5.4 with Distributed Safety Version 5.4. PROFIBUS or PROFINET IO is used as a bus system.

Knowledge of how to operate the STEP 7 software is assumed in the following.



You can find notes on the configuration and commissioning of the CPX terminal in the description of the bus node.

1. Integrate the GSDML/GSD file in the configuration software of the F-Host → Description of the bus node.
2. Configure the CPX terminal including the input module with the configuration software of the F-Host.
Integrate CPX terminal in the configuration → Description of the bus node.
3. In the configuration table, double-click the row of input module CPX-F8DE-P.
The dialogue window “Properties – F8DE-P” is displayed.

“Addresses”
register

4. Set the required starting addresses for inputs and outputs → Fig. 3/3.

Register
“Parameter”

5. Set standard parameters on the input module.

In online mode here, the PROFIsafe addresses of the DIL switch settings are displayed.

3. Commissioning

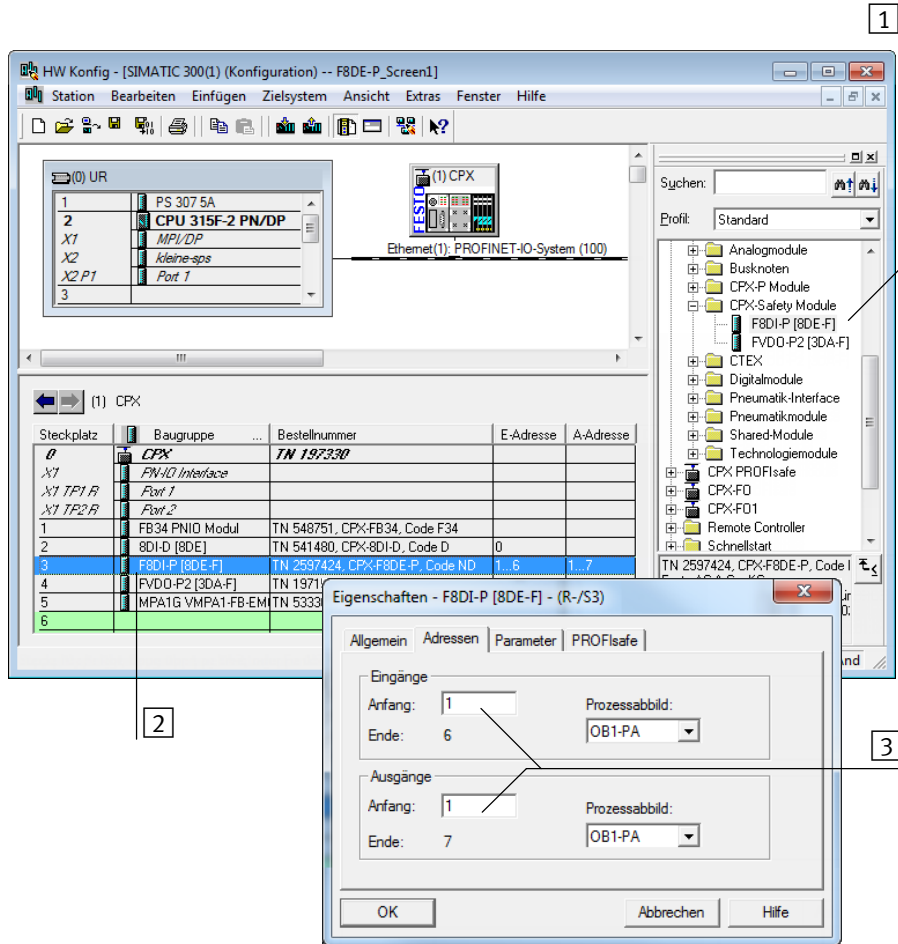

- 1 Input module CPX-F8DE-P in the hardware catalogue
- 2 Input module CPX-F8DE-P in the configuration table if the CPX terminal
- 3 Starting addresses of the input module for inputs and outputs (here 1)

Fig. 3/3: CPX terminal configuration with Siemens STEP 7 – HW Config

3. Commissioning

“PROFIsafe”
register

- For parameter [F_Dest_Add], set a correct PROFIsafe target address → Fig. 3/4.
The target address must match the PROFIsafe address set on the input module using the DIL switch → Fig. 2/2.

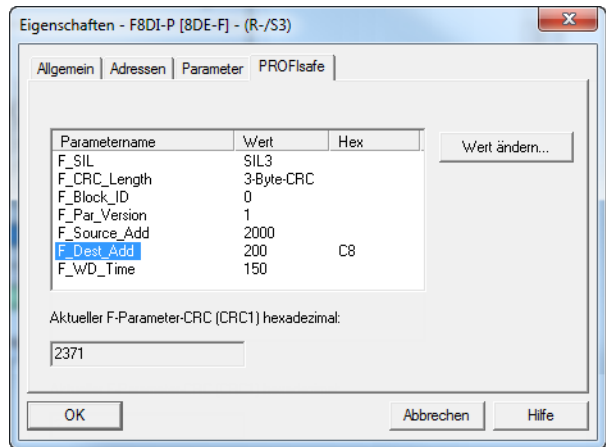

Fig. 3/4: PROFIsafe parameters



In this register you have access to the PROFIsafe parameters of the input module. You can find detailed information about the individual parameters in Chapter 3.6.

3. Commissioning

3.8.1 Addressing example

Addressing example: CPX terminal with MPA pneumatics

Addresses from input/output byte 0 used:

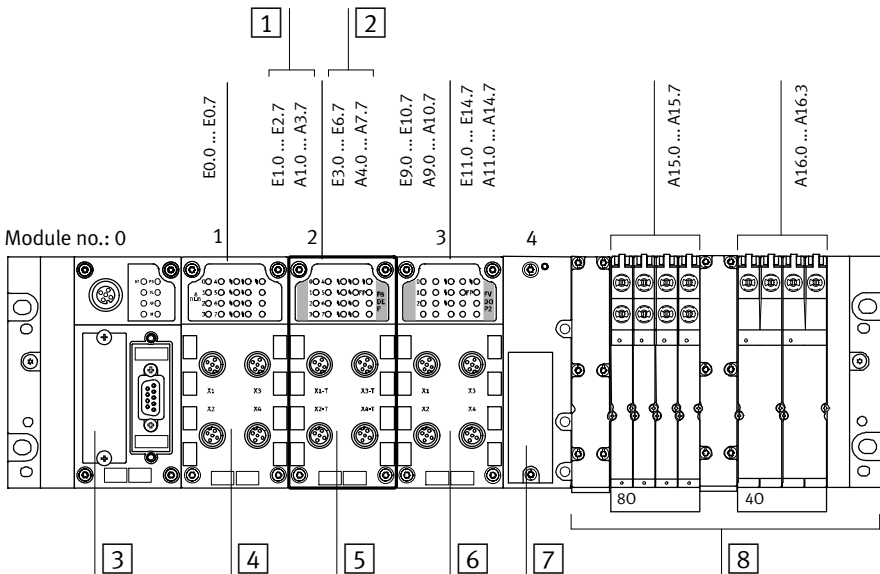

- | | | | |
|---|---|---|---------------------------|
| 1 | F-usage data: 2 Byte Safety inputs and 3 Byte Safety outputs | 5 | Input module CPX-F8DE-P |
| 2 | Not usable range (each 1 byte for status/control and 3 bytes CRC) | 6 | Output module CPX-FVDA-P2 |
| 3 | Bus node CPX-FB13 | 7 | Pneumatics interface |
| 4 | Input module with 8 digital inputs and diagnostics | 8 | MPA pneumatics |

Fig. 3/5: Addressing example

3. Commissioning

no.	Module	Input address	Output address
0	Bus node CPX-FB13	–	–
1	Digital 8x input module with single-channel diagnostics CPX-8DI-D	0	–
2	Safety input module CPX-F8DE-P	1 ... 6	1 ... 7
3	Safety output module CPX-FVDA-P2	9 ... 14	9 ... 14
4	MPA: Pneumatic interface	–	–
5	MPA: Pneumatic module VMPPA1-FB-EMG-8 [8DO]	–	15
6	MPA: Pneumatic module VMPPA2-FB-EMG-4 [4DO]	–	16

Tab. 3/6: Input and output addresses for the example → Fig. 3/5

3. Commissioning

Operation

Chapter 4

4. Operation

Contents

4.	Operation	4-1
4.1	LED status display	4-3
4.1.1	Behaviour during the start-up phase (Startup)	4-4
4.1.2	Normal operating status	4-4

4. Operation

4.1 LED status display

- 1 Module error LED (red)
- 2 FP LED (green) - Failsafe Protocol
- 3 Channel error LED (red); one per input channel
- 4 Status LED (green); one per input channel

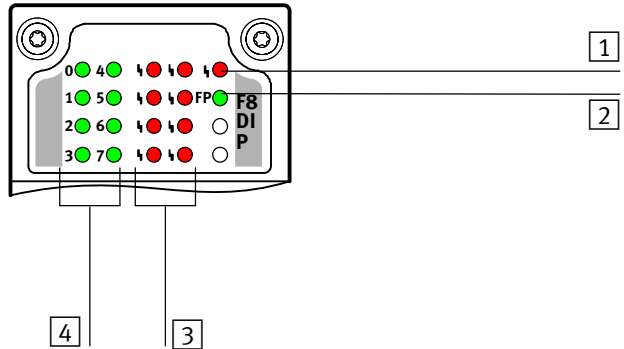

Fig. 4/1: LED display of input module CPX-F8DE-P

In normal operating status, the following LEDs light up:

- FP LED 2
- Status LEDs 4 on the active input channels

The status LEDs on inactive input channels and the module error LEDs 1 and channel error LEDs 3 do not light up.



Note

The designations of the LEDs correspond to the physical contacts E0 to E7.









- Note the special position of the input signals in the input diagram of the CPX-F8DE-P → Chapter 1.2.3.



Detailed information on error characteristics can be found in chapter 5.3.1.





4. Operation

4.1.1 Behaviour during the start-up phase (Startup)

no.	Status LED	Channel error LED	FP LED	Module error LED	I/O illustration	Event/ status
1				 500 ms	0	Start-up of the operating voltage power supply VE _L /SEN (Startup)
2					0	Waiting for secure communication with the control unit (Safety Parameter)

Tab. 4/1: Behaviour during the start-up phase





4.1.2 Normal operating status

Status LED	Channel error LED	FP LED	Module error LED	I/O illustration	Event/ status
Like sensor signal	 ¹⁾			1 ²⁾	PROFIsafe communication running.
Like sensor signal	 ¹⁾			0	PROFIsafe communication running. Channel error detected at input.
		 LED flashes rapidly			PROFIsafe communication running. Operator Acknowledge Requested

¹⁾ Refers to the input channel to which the relevant status LED is assigned.

²⁾ Input diagram based on calculation of operating mode.

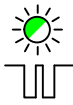
4. Operation

Status LED	Channel error LED	FP LED	Module error LED	I/O illustration	Event/ status
					Parameter received, but no PROFIsafe communication. Possible causes of the fault: <ul style="list-style-type: none"> – Parameter error – Communication timeout – Communication error – PROFIsafe address is not correct.
					Error. Device in a safe functional condition.
					Possible causes of the fault: <ul style="list-style-type: none"> – Module fault – Undervoltage – overvoltage – Excessive temperature – Channel error with module passification.
					Application running, PROFIsafe parameters missing.
			 LED flashes rapidly		Self-test error

Tab. 4/2: Normal operating status

4. Operation

Diagnostics and error handling

Chapter 5

Contents

5.	Diagnostics and error handling	5-1
5.1	Overview	5-3
5.2	Error characteristics	5-4
5.3	Diagnosis via LEDs	5-6
	5.3.1 Behaviour in response to original module faults	5-10
	5.3.2 Behaviour in response to channel faults	5-11
5.4	Diagnostics via the bus node	5-13
	5.4.1 Diagnostics with the operator unit CPX-MMI	5-13

5.1 Overview

The CPX terminal offers extensive possibilities of diagnosis and error treatment. The input module supports the following diagnostic and error handling facilities:

Diagnostics option		Brief description	Reference
On-site diagnostics	LED	The LEDs on the input module display errors in the input channel and modules.	→ Chapter 5.3
	Operator unit (MMI)	On the operator unit, diagnostic information from the input module can be displayed conveniently with menu navigation.	→ Chapter 5.4.1 as well as description of the operator unit
Diagnostics via bus node	System status interrogation (status bits interrogation)	8 status bits of the CPX terminal display common diagnostics messages (global error messages)	→ CPX system description and description of the bus node
	I/O diagnostics interface	CPX-F8DE-P reports specific faults as fault numbers to the bus node. The I/O diagnostic interface enables these data to be interrogated.	→ Tab. 5/2 → CPX system description
	Fieldbus specific diagnostics	Dependent on the bus node (e.g. DPV1)	→ Description of the bus node

Tab. 5/1: Diagnostics options

Reported errors can be evaluated, depending on the bus protocol used. The errors are indicated on-site via the Error LED and, if necessary, can be evaluated with the operator unit.



Information about the diagnostic options on the complete CPX terminal and/or all modules can be found in the CPX system description and/or in the description of the bus node employed.



Note

Ensure that the diagnostic messages cannot be evaluated for safety-related measures.

5.2 Error characteristics

The input module distinguishes between types of error and responds accordingly with:

- Channel passivation if a failure can be allocated to precisely that channel (e.g. with cross-circuiting detection).
- Module passivation if the fault that occurs cannot be allocated precisely to one channel and no component defect is detected (e.g. communication failure with PROFIsafe).
- Safe shut-down if a single microcontroller detects the failure of a component that is required to run the program.
- Passivation as a result of the incorrect setting of a function mode.

The input module can only transmit certain error messages as a function of the selected function mode.

No.	Fault messages	Function mode										
		0	1	2	3	4	5	6	7	8	9	10
02	Channel fault short circuit 24V	–	–	–	✓	✓	–	✓	✓	✓	–	–
02	Module error short circuit 0 V on cycle output T1357	✓	✓	✓	✓	✓	✓	✓	✓	✓	✓	✓
03	Channel fault, wire break	–	–	–	–	✓	–	–	✓	–	–	–
05	Module fault, undervoltage	✓	✓	✓	✓	✓	✓	✓	✓	✓	✓	✓
29	Channel fault, configuration, e.g. invalid function mode	–	–	–	–	–	–	–	–	–	–	–
55	Channel fault, process value	–	–	–	–	–	✓	✓	–	✓	✓	✓
61	Module fault, overvoltage	✓	✓	✓	✓	✓	✓	✓	✓	✓	✓	✓
65	Module fault F_DEST_ADD, differing results	✓	✓	✓	✓	✓	✓	✓	✓	✓	✓	✓

5. Diagnostics and error handling

No.	Error messages	Function mode										
		0	1	2	3	4	5	6	7	8	9	10
66	Module fault, communication	✓	✓	✓	✓	✓	✓	✓	✓	✓	✓	✓
67	Module fault, communication, timeout	✓	✓	✓	✓	✓	✓	✓	✓	✓	✓	✓
68	Channel fault, cross-circuiting	-	-	-	✓	✓	-	✓	✓	✓	-	-
69	Module fault, parameters	✓	✓	✓	✓	✓	✓	✓	✓	✓	✓	✓
75	Module fault, overtemperature	✓	✓	✓	✓	✓	✓	✓	✓	✓	✓	✓
80	Channel fault, channel function	✓	✓	✓	✓	✓	✓	✓	✓	✓	✓	✓
145	Module fault during self-test	✓	✓	✓	✓	✓	✓	✓	✓	✓	✓	✓

Tab. 5/2: Error messages

5.3 Diagnosis via LEDs

For the on-site diagnostics, the following LEDs are located under the transparent cover of the module:

- 1 Module error LED (red)
- 2 FP-LED (green) - Failsafe Protocol
- 3 Channel error LED (red); one per input channel
- 4 Status LED (green); one per input channel

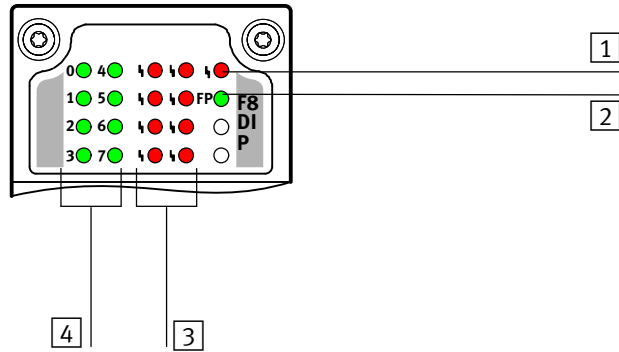

Fig. 5/1: LED display of input module CPX-F8DE-P



Note

The LED display on the input module is not designed in a safety-compliant manner.

- Note that the LEDs may **not** be evaluated for safety-related measures.

When switching on the operating voltage power supply $U_{EL/SEN}$, module fault LED 1 lights up for approx. 500 ms.





Until the input module parameters have been defined correctly by a PROFIsafe-Master, the FP-LED 2 will flash.

In normal operating status, the following LEDs light up:

- FP-LED 2
- Status LEDs 4 on the active input channels

The status LEDs on inactive input channels and the module error LEDs 1 and channel error LEDs 3 do not light up.



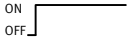

5. Diagnostics and error handling

Module error LED			
LED (red)	Sequence	Status	Significance / error handling
 <p>LED is off</p>		Faultless operation	–
 <p>LED flashes quickly</p>		<ul style="list-style-type: none"> – Self-test fault, input module in safe mode – Internal communication problem 	<ul style="list-style-type: none"> • Switch operating voltage on and off (Power Off/On). ¹⁾
 <p>LED illuminated</p>		<p>Module fault</p> <ul style="list-style-type: none"> – Undervoltage – Overvoltage – Overtemperature – Absence of safety parameterization – Defective safety communication – Channel fault during configuration “Module-based passivation” 	<ol style="list-style-type: none"> 1. Remedy cause of fault 2. Correct the parameterization 3. Reintegrate the input module





¹⁾ If self-test faults reoccur: Replace the input module.

Tab. 5/3: Module error LED

5. Diagnostics and error handling





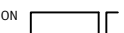





Channel error LED			
LED (red)	Sequence	Status	Significance / error handling
 LED is off		Faultless operation	–
 LED flashes	Blink code is fault-specific	<ul style="list-style-type: none"> – Short-circuit with 24 V – Wire break – Cross circuit – Functional fault – Module expects reintegration 	<ul style="list-style-type: none"> • Fault analysis and remedial action in accordance with Tab. 5/8
 LED illuminated		<ul style="list-style-type: none"> – Configuration error – Invalid process value 	<ul style="list-style-type: none"> • Fault analysis and remedial action in accordance with Tab. 5/8

Tab. 5/4: Channel error LED

Status LED ¹⁾		Function mode										
LED (green)	Sequence	0	1	2	5	9	10	3	4	6	7	8
 LED is off		A signal is not present at the input.	A signal is not present at the input.					A signal is not present at the input.				
 LED illuminates		Any signal is present at the input.	A static signal is present at the input.					A static signal is present at the input.				
								The module's own, equivalent clock signal is present at the input.				
 LED briefly turns off once		–	A clock signal is present at the input.					–				
1) The status LED follows the signal present at the input channel.												

Tab. 5/5: Status LED

5. Diagnostics and error handling

















FP-LED (FP for Failsafe protocol)			
LED (green)	Process	PROFIsafe status	Significance / error handling
 LED flashes 2 x briefly out	ON  OFF	– Wait for Safety Parameter	– Input module waits for parameterization by the F-Host
 LED flashes slowly	ON  OFF	– Address fault – Communication error – Communication timeout – Parameter error	– Set PROFIsafe address does not correlate with safety parameterization. – Safety parameterization invalid – PROFIsafe communication cannot be established
 LED flashes quickly	ON  OFF	– Operator Acknowledge possible	– No module faults are present, and reintegration is possible
 LED illuminated	ON  OFF	– Failsafe protocol active	– Input module communicates with an F-Host via a PROFIsafe protocol.
 LED is off	ON  OFF	– Input module is in a safe shut-down condition	–

Tab. 5/6: FP-LED

- After remedial action, reintegrate the input module.

5. Diagnostics and error handling

5.3.1 Behaviour in response to original module faults

Channel error LED	FP-LED	Module error LED	Error no.	Error description	Remedy
			5	Undervoltage in the power supply	<ul style="list-style-type: none"> Correct power supply voltage or remedy the short circuit
			61	Overvoltage of the supply voltage	<ul style="list-style-type: none"> Correct power supply voltage
			65	Set PROFIsafe address does not correlate with safety parameterization (F_Dest_Add)	<ul style="list-style-type: none"> Check and correct set address / parameter → Chapter 2.4 and 3.8 Transmit new parameters
			66	Error in safe communication	<ul style="list-style-type: none"> Rectify source of fault
			67	The chronological sequence for PROFIsafe communication is impaired	<ul style="list-style-type: none"> Check communication paths Check timeout time → Chapter 3.8
			69	Fault in safe parameterization (safety parameterization invalid)	<ul style="list-style-type: none"> Check parameters in the PROFIsafe protocol Transmit new parameters
			75	Overtemperature of the input module Short circuit/overload in a cycle output	<ul style="list-style-type: none"> Remedy overtemperature Remedy short circuit/overload on T0, T2, T4, T6
			145	Input module has detected a fault during a self-test	<ul style="list-style-type: none"> Switch CPX terminal back on again Replace the input module









Tab. 5/7: Behaviour in response to module faults

All input channels on the input module are passivized in response to module faults











- After remedial action: Reintegrate the input module.

5. Diagnostics and error handling

5.3.2 Behaviour in response to channel faults

Status LED	Channel error LED	Module error LED	Error no.	Error description	Remedy
	 LED flashes slowly	 ¹⁾	2	<ul style="list-style-type: none"> – Short circuit 24 V on input signal – No cycle – Incorrect connection technology 	<ul style="list-style-type: none"> • Check sensors and wiring • Adapt connection technology or function mode
			2	<ul style="list-style-type: none"> – FE or 0 V connected to T1, T3, T5 or T7 	<ul style="list-style-type: none"> • Check sensors and wiring • Check signal form at module input
	 LED flashes once off	 ¹⁾	3	<ul style="list-style-type: none"> – No signal – Antivalent signal not present prior to enabling of the safety function – FE connected to T1, T3, T5 or T7 	<ul style="list-style-type: none"> • Check sensors and wiring • Check normally closed contact of the sensor • Request antivalent sensor signal
		 ¹⁾	29	<ul style="list-style-type: none"> – Fault in the parameterization 	<ul style="list-style-type: none"> • Set permitted mode
		 ¹⁾	55	<ul style="list-style-type: none"> Function mode-dependent fault in process value – Discrepancy – No request for standby position on the application – Unauthorized logical value 	<ul style="list-style-type: none"> • Assure correct logical and time-related reporting values of sensors
				<ul style="list-style-type: none"> – Incorrect connection block installed – FE connected to T1, T3, T5 or T7 – Loose contact on two-channel sensors 	<ul style="list-style-type: none"> • Check sensors and wiring

5. Diagnostics and error handling

Status LED	Channel error LED	Module error LED	Error no.	Error description	Remedy
	 LED flashes 2 x briefly Off	 ¹⁾	68	With cycle monitoring: – Unauthorized cycle – Several cycles at input – Clock signals swapped	<ul style="list-style-type: none"> • Check sensors and wiring • Check wiring of Clock signals
	 LED flashes rapidly	 ¹⁾	80	– Internal monitoring has detected unexpected interference on the affected input channel	<ul style="list-style-type: none"> • Check sensors for faulty signals
	 LED flashes once briefly On		–	– Channel fault has been rectified, qualification bit is still “0”	<ul style="list-style-type: none"> • Acknowledge error • Reintegrate the input module
			–	<ul style="list-style-type: none"> – No signal at module input – Input signal follows the cycle after too much of a delay – Loose contact, signal fails 	<ul style="list-style-type: none"> • Check sensors and wiring • Check signal form at module input
¹⁾ Module fault LED lights up while “Channel-based passivation” is disabled.					

Tab. 5/8: Behaviour in response to channel faults

- After remedial action, always reintegrate the input module.

5.4 Diagnostics via the bus node



Information about diagnostics of the bus node you are using can be found in the description of the corresponding bus node.

5.4.1 Diagnostics with the operator unit CPX-MMI

The operator unit displays current error messages from the input module in clear text.

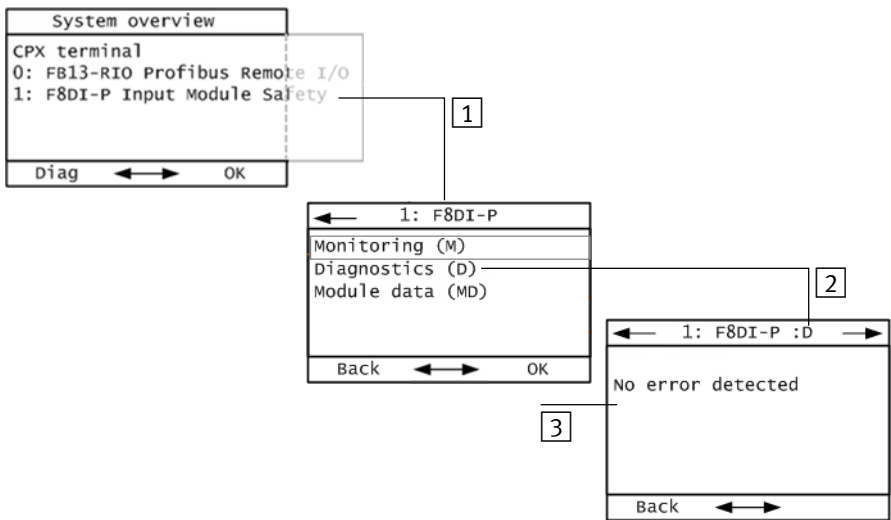

1 Select module in the main menu (module 1 here)

2 Select menu item “Diagnostics”

3 Current module error (here: none)

Fig. 5/2: Module identifier of input module CPX-F8DE-P on operator unit



Furthermore, the operator unit offers access to the diagnostic memory → Description P.BE-CPX-MMI-1-...

5. Diagnostics and error handling

Service, repair, waste management

Chapter 6

6. Service, repair, waste management

Contents

6.	Service, repair, waste management	6-1
6.1	Service	6-3
6.2	Repair	6-3
6.3	Disposal	6-4

6. Service, repair, waste management

6.1 Service

The input module does not contain any components requiring maintenance.

6.2 Repair

Input module CPX-F8DE-P does not contain any wearing parts.



Note

Repairs are impermissible. Repairs cause the input module to lose its compliance status.

A professional replacement of the electronics module is permissible.



Note

- In the event of an internal defect, replace the input module.
- Send the unmodified, defective input module back to Festo for analysis together with a description of the fault and the application involved.



Disassembly and assembly of the electronic module
→ Section 2.3.

6. Service, repair, waste management

6.3 Disposal

The material used in the packaging has been specifically chosen for its recyclability.

For final disposal of the input module, please contact a certified waste disposal business for electronic (WEE) scrap.

Technical appendix

Appendix A

Contents

A.	Technical appendix	A-1
A.1	Technical data	A-3
	A.1.1 Safety characteristics	A-3
	A.1.2 Characteristic values of the input module	A-5
A.2	Technical data of the connection blocks	A-8

A.1 Technical data



General technical data of the CPX terminal → CPX system description P.BE-CPX-SYS...

A.1.1 Safety characteristics

Safety characteristics	Function mode										
	1	2	3	4	5	6	7	8	9	10	
Safety classification CPX-F8DE-P											
– to EN ISO 13849-1	PL d, Cat. 2 ¹⁾			thru PL e, Cat. 4							
– in accordance with EN 61508	SIL 2 ¹⁾			thru SIL 3							
– in accordance with EN 62061	SIL CL 2 ¹⁾			thru SIL CL 3							
T _{WCDT} Worst Case Delay Time (Max. internal response time to the input signal)	[ms]	15	15	60	120	15	60	120	580	15	15
DC _{AVG} Average Diagnostic Coverage (average diagnostic coverage level)	[%]	80 ²⁾		99							
SFF Safe Failure Fraction (proportion of safe failures)	[%]	84 ³⁾		99							
Minimum period of request		> Internal reaction time									
PROFIsafe watchdog time	[ms]	F_WD_Time									
Max. reaction time to a change in input	[ms]	F_WD_Time + T _{WCDT}									
¹⁾ Characteristic value for testing the application within 24 hours: Thru PL eKat 3, SIL 3, SIL CL 3 ²⁾ Characteristic value for testing the application within 24 hours: DC _{AVG} = 94% ³⁾ Characteristic value for testing the application within 24 hours: SFF = 95%											

A. Technical appendix

Safety characteristics	All function modes
T _{DAT} Device Acknowledge Time (internal PROFIsafe processing time) [ms]	< 20
MTTF _d Mean Time To dangerous Failure (average time before a hazardous failure occurs) [years]	> 2500
PFH _D Probability of dangerous Failure per Hour (probability of a dangerous failure occurring within a given one-hour period)	1.0 x 10 ⁻⁹
HFT Hardware fault tolerance (Hardware-Failure-Tolerance)	1
Classification according to EN 61508-2:2010-05	Type B
β Beta factor for common cause failures CCF (Common Cause Failure) [%]	2
Max. duration of use [years]	20
Safety protocol	Profile for Safety Technology on PROFIBUS DP and PROFINET IO; Version 2.4, March 2007
Type test → www.festo.com/sp	The functional safety of the product has been certified by an independent testing body, see EC type test certificate.
CE marking → Declaration of conformity → www.festo.com/sp	according to EC Machinery Directive 2006/42/EC according to EC EMC Directive 2004/108/EC
Certificate issuing authority	01/205/5444.00/15

Tab. A/1: Safety characteristics

A. Technical appendix

A.1.2 Characteristic values of the input module

Electric characteristic values		
Nominal DC operating voltage	[V DC]	24
Residual ripple (peak-to-peak) in operating voltage range $U_{EL/SEN}$	[V _{SS}]	2
Permitted voltage tolerance	[%]	-15 ... +20
Operating voltage	[V DC]	20.4 ... 28.8
Voltage drop bypass time for the internal electronics	[ms]	10
Intrinsic current consumption at nominal operating voltage	[mA]	typ. 35
Undervoltage monitoring $VEL_{/SEN}$	[V]	$V < 19.5$ for $t > 250$ ms
Overvoltage monitoring $VEL_{/SEN}$	[V]	$V < 29.5$ for $t > 250$ ms
Potential reference for the input channels		$VEL_{/SEN}$
Electrical isolation between channels		no
Input characteristics according to IEC 61131-2 for digital inputs		Type 2
Max. accepted test pulse duration at input	[ms]	0.7
Max. load current per clock line T0, T2, T4, T6	[A]	0.7
Max. total current on T1, T3, T5, T7	[A]	0.2
Max. output current at 24V terminals	[A]	2
Max. total current per input module	[A]	3
Cable lengths to sensor		
– Cable type LiFY11Y-OB, unshielded, 3 x 0.14 sq.mm	[m]	200

A. Technical appendix

Electric characteristic values		
– Cable type LiF9Y11Y, unshielded, 4 x 0.10 sq.mm	[m]	200
– Cable type LiYCY, shielded, 4 x 0.14 sq.mm	[m]	200

Tab. A/2: Electric characteristic values

Properties of the clock signals		
duty clock	[ms]	50 (±6)
Pulse duration	[ms]	12
Max. time delay for input signal after clock signal		
– with falling edge	[ms]	1.7
– with rising edge (sensor switched back on again)	[ms]	25

Tab. A/3: Properties of the clock signals

Module characteristic values	Function mode										
	0	1	2	3	4	5	6	7	8	9	10
Module code	28d (1Ch)										
Sub-module code	1d (01h)										
Number of inputs	8										
Switching logic at inputs	PNP (positive-switching)										
Compatible with Fast-Start-Up (FSU)	Yes										

A. Technical appendix

Module characteristic values	Function mode										
	0	1	2	3	4	5	6	7	8	9	10
Time for switch-on phase until input module is ready (startup) [s]	< 2										
Max. tolerance time until diagnostic message of channel fault [s]	–	–	–	0.5	10	0.5	0.5	10	2	2	2

Tab. A/4: Module characteristics

Ambient characteristics	
Ambient operating temperature [°C]	–5 ... +50
Ambient temperature during storage and transportation [°C]	–20 ... +70
Relative humidity (non-condensing) [%]	5 ... 90
Degree of contamination according to DIN EN 60664-1:2007	≤ 2
Degree of protection in accordance with IEC 60529	Depending on the connection block ¹⁾
Electromagnetic compatibility (EMC) – Immunity to interference and emitted interference	Declaration of conformity → www.festo.com/sp
UL certification	c UL us - Recognized (OL)
¹⁾ → Appendix A.2	

Tab. A/5: Ambient characteristics

A.2 Technical data of the connection blocks



General technical data of the CPX terminal → CPX system description P.BE-CPX-SYS...

CPX-M-AB-4-M12X2-5POL-T	
Degree of protection in accordance with EN 60 529 ¹⁾	IP65, completely mounted, plug connector inserted or provided with protective cap ISK-M12
Housing material	Die-cast aluminium
Ports	
– design	4 sockets M12, metal thread, 5-pin
– Contact load capacity	4 A
¹⁾ Degree of protection is reached through the permitted combination with interconnection block and connectors.	

Tab. A/6: Technical data CPX-M-AB-4-M12X2-5POL-T

CPX-M-AB-4-M12X2-5POL	
Degree of protection in accordance with EN 60 529 ¹⁾	IP65, completely mounted, plug connector inserted or provided with protective cap ISK-M12
Housing material	Die-cast aluminium
Ports	
– design	4 sockets M12, metal thread, 5-pin
– Contact load capacity	4 A
¹⁾ Degree of protection is reached through the permitted combination with interconnection block and connectors.	

Tab. A/7: Technical data CPX-M-AB-4-M12X2-5POL

A. Technical appendix

CPX-AB-8-KL-4POL	
Degree of protection in accordance with EN 60 529 ¹⁾	– IP20, completely mounted, cable connected to terminal strip – IP65, completely installed, with cover AK-8KL
Housing material	Reinforced polyamide, polycarbonate
Ports	
– design	2 terminal strips
– Contact load capacity	4 A
¹⁾ Degree of protection is reached through the permitted combination with interconnection block and connectors.	

Tab. A/8: Technical data CPX-AB-8-KL-4POL

CPX-AB-ID-P	
Degree of protection in accordance with EN 60 529 ¹⁾	IP65, completely installed
Housing material	Reinforced polyamide, polycarbonate
¹⁾ Degree of protection is reached through the permitted combination with interconnection block.	

Tab. A/9: Technical data CPX-AB-ID-P

A. Technical appendix

Index

Appendix B

Contents

B.	Index	B-1
B.1	Index	B-3

A

Abbreviations, Product-specific	XXIV
Achievable safety classification	XI
Acknowledgment	XXIV
Acknowledgment sequence	1-16
Addressing example	3-16

B

Behaviour in the event of an error	5-10, 5-12
Black channel	XXIV

C

category	XXIV
CCF	XIII
Channel error LED	5-8
Channel-wise passivation	1-15
Commissioning	3-6
components	1-4
Connection	2-10
Connection blocks	1-4
Connection of sensors	2-13
CRC signature	XXIV
Cross circuit	XXIV
Cross-shorting monitoring	XXIV
Cycle monitoring	XXIV

D

Diagnostics	
on the operator unit (MMI)	3-12
via LED	5-6
Diagnostics	5-6
Diagnostics option	5-3
DIL switch setting	3-10
DIL switches	2-11
Dismantling	2-10

E

Electronics module	1-6
Error messages	5-4

F

F-user data	1-12, 3-16
Feature	
CPX-AB-8-KL-4POL	1-5
CPX-AB-ID-P	1-5
CPX-F8DE-P (Elektronikmodul)	1-6
CPX-M-AB-4-M12X2-5POL	1-4
CPX-M-AB-4-M12X2-5POL-T	1-4
CPX-M-GE-EV	1-7
CPX-M-GE-EV-S-7/8-5POL	1-7
CPX-M-GE-EV-S-7/8-CIP-4P	1-7
CPX-M-GE-EV-S-PP-5POL	1-7
CPX-M-GE-EV-Z-7/8-5POL	1-8
CPX-M-GE-EV-Z-PP-5POL	1-8
Forced dynamisation	XXV
FP-LED	5-9
Function mode	1-20

G

GSD-/GSDML file 3-4

I

Input data 1-14

Intended use VII

L

LED

Channel error LED 5-8

FP-LED 5-9

Module error LED 5-7

Status LED 5-8

M

Manifold blocks 1-6

Misuse X

Module error LED 5-7

Module identifiers 3-4

Module parameters, DIL switch setting 3-10

Module-based passivation XXVI

O

On-site diagnostics 5-6

operating status 4-5

Operator unit 3-11, 5-13

Output data 1-13

P

Parameter	
CPX module parameters	3-9
PROFIsafe parameters	3-7, 3-15
Passivation	XXVI, 1-15
Channel-wise	XXIV
Performance Level	XXVI
Pictograms	XXIII
Presetting	3-9
Process image	1-12
Product design	VIII
Product version	1-9
PROFIsafe	1-11
GSD-/GSDML file	3-4
Process image	1-12
PROFIsafe address	XXVII, 2-11
PROFIsafe parameters	3-7, 3-15
F_Block_ID	3-7
F_Check_iPar	3-7
F_Check_SeqNo	3-7
F_CRC_Length	3-7
F_Dest_Add	3-8
F_iPar_CRC	3-8
F_Par_Version	3-8
F_SIL	3-7
F_Source_Add	3-8
F_WD_Time	3-8
PROFIsafe status	4-4
Protection class	2-14

R

Recommended sensors	1-20
Reentry	XXVII
Reintegration	XXVII
Replacement	6-3

S

Safety chain	XXVIII
Safety circuit	XXVIII
Safety classification	XXVIII
Safety instructions	VI
Safety integrity	XXVIII
Safety integrity level	XXVIII
Sensor	XXVIII
servicing	XVI
Signal display	
on the operator unit (MMI)	3-12
through status LED	4-3, 5-6
Specifications, Function characteristic values	A-6
Starting phase	4-4
Status LED	5-8

T

technical data

Ambient characteristics	A-7
Connection blocks	A-8
Electric characteristic values	A-5
Safety characteristics	A-3
Test pulse	XXIX
Text markings	XXIII
Transport and storage conditions	XVI

U

User instructions	XXII
-------------------------	------