

# Proportional pressure regulator MPPE-3-...B

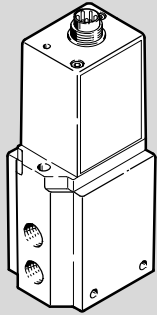

**Festo SE & Co. KG**  
Rüter Straße 82  
73734 Esslingen  
Germany  
+49 711 347-0  
www.festo.com

Operation instructions  
Original instructions

8075536  
2017-07  
[8075538]

English



For all available product documentation → [www.festo.com/pk](http://www.festo.com/pk)

## 1 Overview

### 1.1 Control sections and connections

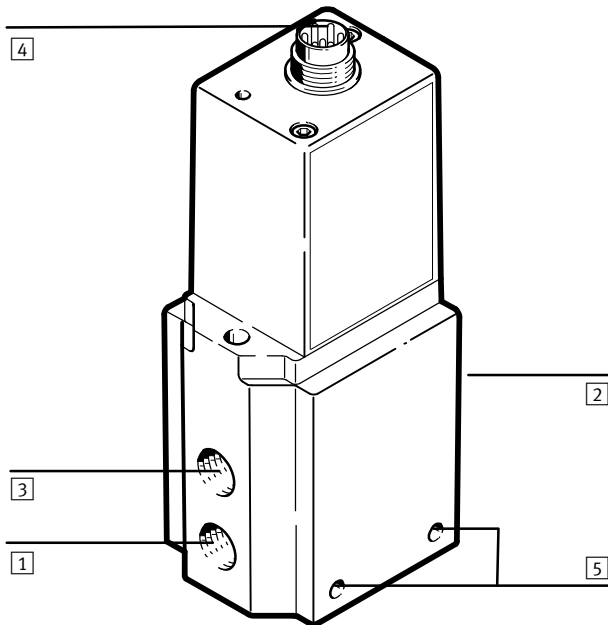

- |   |                             |
|---|-----------------------------|
| 1 Compressed air supply port (pressure input)   | 3 Exhaust port              |
| 2 Air supply port at the rear (pressure output) | 4 Electrical connection     |
|   | 5 Through-hole for mounting |

Fig. 1

## 2 Function and application

The MPPE-... is designed to control pressure proportionately to a specified, electrical setpoint value.

A built-in pressure sensor records the pressure at the air supply port. The electronic control unit compares the pressure value with the setpoint value. An analogue, electrical signal is issued corresponding to the output pressure. If the actual value differs from the setpoint value, the regulating valve is actuated until the output pressure reaches the setpoint value.

- Make sure that the MPPE-... is not subjected to high-frequency irradiation (e.g. by radio sets, mobile telephones or other devices which cause interference). In this way you will avoid increased tolerances in the output pressure (for further information refer to the EMC specifications in the chapter "Technical data").
- Only operate the MPPE in unlubricated condition. When using bio-oils (oils which are based on synthetic or native ester, e.g. rapeseed oil methyl ester), the maximum residual oil content of 0.1 mg/m<sup>3</sup> must not be exceeded (ISO 8573-1-2010 Class 2).

## 3 Prerequisites for use



### Note

General conditions for the correct and safe use of the product, which must be observed at all times:

- Maintain the specified limit values (e.g. for pressures, forces, torques, temperatures and electric voltage).
- Ensure there is a supply of prepared compressed air to ISO 8573-1:2010 [7:4:4], inert gases.
- Please observe the prevailing ambient conditions.
- Also observe the regulations of the trade association, the German Technical Control Board (TÜV), the VDE and relevant national regulations.



### Note

- Remove all transport packaging such as protective wax, foils, caps, cartons (except for plugs in the pneumatic connections). The individual materials can be stored in containers for recycling purposes.
- Pressurise your entire system slowly (e.g. according to Fig. 2) to avoid any uncontrolled movements.
- Please observe the warnings and instructions:
  - on the product
  - in these operating instructions.
- Use the product in its original state, without any unauthorised product modifications.

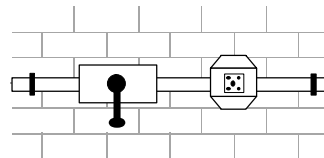

Fig. 2

## 4 Installation

### 4.1 Mechanical

- Handle the MPPE-... with care so that the electrical connection is not damaged. Such damage will reduce operational reliability.

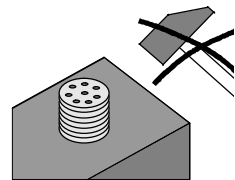

Fig. 3

- Make sure there is sufficient space for the cable connection and tube couplings. In this way you will prevent the connecting cable from being bent.
- Keep the lines between the MPPE-... and the application as short as possible. This will result in enhanced control precision and shorter response times.
- Insert the screws for mounting into the two holes [5].
- Secure the MPPE-... at the intended position.

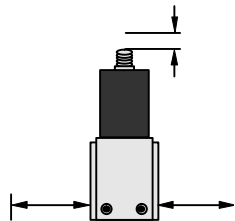

Fig. 4

#### 4.2 Pneumatic

- Remove the sealing elements from the compressed air ports.
- Attach the pneumatic tubing to the following connections (position of the connections → Fig. 1):
  - Compressed air supply port [1]
  - Air supply port [2]
- Screw a silencer (accessories → [www.festo.com/catalogue](http://www.festo.com/catalogue)) into the exhaust port [3].

#### 4.3 Electric



#### Warning

- Use only PELV circuits in accordance with IEC/DIN EN 60204-1 (protective extra-low voltage, PELV) for the electrical power supply.
- Also observe the general requirements for PELV circuits in accordance with IEC/DIN EN 60204-1.
- Use only power sources that guarantee safe electrical isolation of the operating voltage in accordance with IEC/DIN EN 60204-1.

- Note the rating plate.

A distinction is made between the following valve variants (→ Fig. 5).

Designation on the rating plate	MPPE-...-010B	MPPE-...-420B
Designation	Voltage variant	Current variant
Electrical setpoint value	DC 0 ... 10 V	4 ... 20 mA

Fig. 5



#### Note

- Check the use of the following options on the MPPE-3-... :
  - Reference voltage  $V_{ref}$  of DC 10 V on the valve
  - Scanning an external pressure sensor
  - Measuring the actual voltage/current value
- Use the following accessories (accessories → [www.festo.com/catalogue](http://www.festo.com/catalogue)):
  - Socket with cable or
  - Plug socket and
  - shielded cable.
 You can then guarantee that the specified protection class IP 65 and EMC are fulfilled.
- Wire the screening with earth potential at the cable end away from the MPPE.



#### Note

Make sure that the cable is laid as follows:

- not squashed
- not bent
- not stretched



Fig. 6

- Wire the MPPE-... according to one of the connection diagrams:

#### Voltage variant with external set value voltage

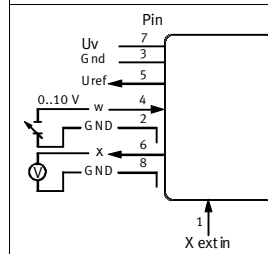

Fig. 7

#### Voltage variant with potentiometer

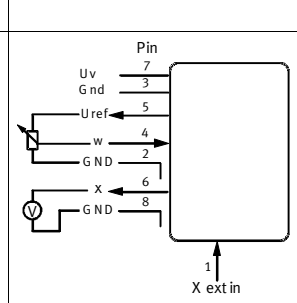

Fig. 8

#### Current variant

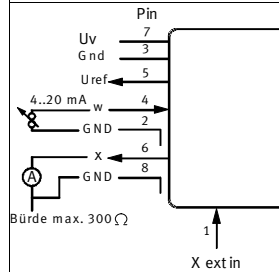

Fig. 9

The individual pins on the electrical connection are assigned as follows:

	Pin number	Description	Voltage variant	Current variant	Cable colour <sup>3)</sup>
	1	X ext in – with actual value reader – without actual value reader	DC 0 ... 10 V 1)	4 ... 20 mA –	White (WH) –
	2	Setpoint value <sup>2)</sup>	GND	GND	Brown (BN)
	3	Supply <sup>2)</sup>	GND	GND	Green (GN)
	4	Setpoint	DC 0...10 V	4...20 mA	Yellow (YE)
	5	Ref. output	DC 10 V	DC 10 V	Grey (GY)
	6	Actual value output	DC 0...10 V	4...20 mA	Pink (PK)
	7	Supply voltage	DC 24 V	DC 24 V	Red (RD)
	8	Actual value <sup>2)</sup>	GND	GND	Blue (BU)

1) Connect to GND for hardware versions from 1.11.98 (see rating plate).

For older hardware versions: no assignment.

2) Connected internally

3) When using the socket with cable type KMPPE-...

Fig. 10

#### 5 Commissioning

- Supply the MPPE-... with direct current (supply voltage  $U_v = DC 24 V$ ).
- Supply the MPPE-... with a setpoint signal.
- Pressurise the MPPE- with an input pressure higher than the maximum required output pressure.

A proportional output pressure  $P_s$  is then set.

Different pressure ranges are assigned to the setpoint signal range DC 0 ... 10 V and 4 ... 20 mA depending on the design (→ Fig. 13 and Fig. 14):

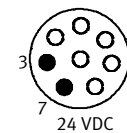

Fig. 11

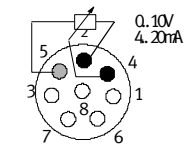

Fig. 12

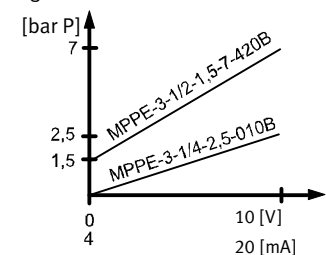

Fig. 13

Type	Setpoint signal range	Pressure range
MPPE-...-(P <sub>u</sub> )-P <sub>o</sub> -010B	DC 0 ... 10 V	P <sub>u</sub> ... P <sub>o</sub> bar
MPPE-...-(P <sub>u</sub> )-P <sub>o</sub> -420B	4 ... 20 mA	P <sub>u</sub> ... P <sub>o</sub> bar
<b>e.g. standard version</b>		
MPPE-3-1/4-2,5-010B	DC 0 ... 10 V	0 ... 2.5 bar
<b>e.g. special adaptation</b>		
MPPE-3-1/2-1,5-7-420B	4 ... 20 mA	1.5 ... 7 bar

Fig. 14

For shorter air supply times:

Recommendation for tube length > 5 m and cylinder volume > 5 l

- Use the external pressure sensor directly on the cylinder.

Because differences in pressure can occur between the valve and cylinder which the internal pressure sensor of the valve does not detect.

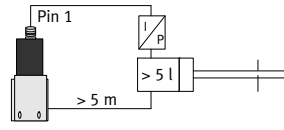

Fig. 15

- Wire the actual output value of the external pressure sensor to Pin 1 on the MPPE-... (input X). The external pressure sensor is then queried automatically instead of the internal pressure sensor.

For visual inspection of the control process:

- Wire the MPPE-... with the following measuring device according to Fig. 16:

Voltage variant (voltage measurement device)	Current variant (Am-meter)

Fig. 16

The actual electrical value can be tracked on the display of the measuring device. This changes proportional to the pressure curve at air supply port [2].

## 6 Operation



### Hinweis

- When switching off the power supply make sure that the compressed air is switched off as well. Otherwise pressure can build up at the valve outlet.
- Make sure the supply pressure P<sub>E</sub>, the output pressure P<sub>A</sub> and the proportional actual value w always exhibit the following relationship:  
0 bar < P<sub>A</sub> (≙ w) < P<sub>E</sub>  
If not, the MPPE-... will wear prematurely through continuous/normal operation.
- Listen for operating noises from the valve (→ Fig. 17).

Noise	Significance
Slight babble:	Normal control procedure
Heavy babble:	Wear!

Fig. 17

**If the same output pressure is still evident despite a modified setpoint value specification:**

- Look for defective cables.  
In the event of fractured setpoint cables (MPPE-...-420B only) or power supply cables, the last specified output pressure is maintained but **not regulated**. Leakage produces a change in output pressure over the long term. The pressure may rise or fall.

## 7 Maintenance and care

- Clean the MPPE-... with soap suds only (max. +60 °C).

## 8 Accessories

→ [www.festo.com/catalogue](http://www.festo.com/catalogue)

## 9 Troubleshooting

Malfunction	Possible cause	Remedy
MPPE-... does not respond	Supply voltage not present	Check the 24 V DC supply voltage connection
	No set value voltage	Check control unit; check connection
	Supply pressure P <sub>E</sub> not present	Increase the supply pressure above the desired setpoint pressure. The supply pressure must be lower than the maximum permissible value (→ Technical data).
MPPE-... defective		Return the MPPE-... to Festo
Flow too low	Restriction of the flow cross section due to connection technology (swivel fittings, silencer too small)	Use an alternative connection
Pressure increase too slow	Large cylinder volume (> 5 l) and tube length (> 5 m)	Connect the external pressure sensor to the cylinder (→ Commissioning)
Heavy babble produced by the MPPE-...	Supply pressure P <sub>E</sub> not present/setpoint signal V <sub>ref</sub> not present (corresponds to the setpoint pressure P <sub>A</sub> )	Increase the supply pressure P <sub>E</sub> . (P <sub>A</sub> < P <sub>E</sub> < P <sub>max</sub> . → Technical data)
	Only applicable for MPPE-...010B (voltage variant) with hardware version from 1.11.98 (see rating plate) without external pressure sensor: Pin 1 (Xext_in) is not connected to GND	

Fig. 18

## 10 Technical data

### 10.1 General data

Voltage variant: MPPE-3-...-010B ≙ DC 0 ... 10 V)

Current variant: MPPE-3-...-420B ≙ 4 ... 20 mA)

Type	MPPE-...
Design	Proportional pressure regulator
Mounting position	As desired, preferably vertical (electronics upward)
Medium	Compressed air to ISO 8573-1:2010 [7:4:4], inert gases
Working pressure	Constant (independent of fluctuations in the compressed air supply). Supply pressure at least 1 bar higher than the max. output pressure
Normal leakage in new condition	< 5 l/h max
Protection class	IP65 in combination with plug socket according to accessories
Permitted temperature range	Ambient temperature: 0 ... + 50 °C Storage temperature: - 20 ... + 70 °C Medium temperature: 0 ... + 60 °C
Permitted supply voltage	DC + 18 ... max. 30 V (nominal value: DC + 24 V)
Reference output current at DC 10 V	< 5 mA
External setpoint value potentiometer	2 kΩ ... 10 kΩ, recommended 4.7 kΩ
Power consumption	max. 3.6 W (at U <sub>vmax</sub> = DC 30 V)
CE mark (see declaration of conformity) <sup>1)</sup>	in accordance with EU EMC Directive → <a href="http://www.festo.com/sp">www.festo.com/sp</a>
Max. cable length	30 m
Linearity	1 % Full Scale
Electrical connection	Pin contact, 8-pin according to DIN 45326
Resolution of actual value output	8 Bit (approx. 40 mV for voltage variant/approx. 0.0625 mA for current variant)
Safety setting	If the power supply cable or the setpoint cable (current) breaks (MPPE-...-420B only), the output pressure is maintained unregulated. In the long-term, a leak will cause a reduction in pressure. In case of a setpoint cable break (voltage) the output pressure is set to 0 bar.
Materials	Housing: Aluminium Cover: Die-cast zinc Seals: Nitrile rubber Sealing compound: Polyurethane Lubrication: Silicone-free
Setpoint variable:	0 ... +10 V (voltage variant) 4 ... 20 mA (current variant)
Permissible load resistance:	min. 2 kΩ (voltage variant) max. 500 Ω (current variant)
Input resistance:	10 kΩ (voltage variant) 250 Ω (current variant)

<sup>1)</sup> The valve is intended for use in an industrial environment. Outside of industrial environments, e.g. in commercial and mixed-residential areas, actions to suppress interference may have to be taken.

Fig. 19

## 10.2 Connection-specific data

Type	MPPE-3-1/8-...	MPPE-3-1/4-...	MPPE3-1/2-...
Connections	1/8	1/4	1/2
Nominal size - pressurisation/exhaust	5 mm/5 mm	7 mm/7 mm	11 mm/12 mm
Weight	650 g	800 g	1900 g

Fig. 20

## 10.3 Product-specific data (part 1)

Type	MPPE-3-1/8-10		MPPE-3-1/4-10		MPPE-3-1/2-10	
	010B	420B	010B	420B	010B	420B
Nominal flow rate $q_n$ 6 → 5 with $p = 11$ bar at 1	1725 l/min		3275 l/min		8800 l/min	
Pressure ranges	– Permissible supply pressure: max. 12 bar – control range: 0...10 bar					
Hysteresis <sup>1)</sup>	max. 50 mbar (with supply voltage: DC 20 ... 30 V) max. 100 mbar (with supply voltage: DC 18 ... 20 V)					
<sup>1)</sup> → EMC specifications (general data)						

Fig. 21

Type	MPPE-3-1/8-6		MPPE-3-1/4-6		MPPE-3-1/2-6	
	010B	420B	010B	420B	010B	420B
Nominal flow rate $q_n$ 3.6 → 3 with $p = 8$ bar at 1	1125 l/min		2550 l/min		6800 l/min	
Pressure ranges	– Permissible supply pressure: max. 8 bar – Control range: 0 ... 6 bar					
Hysteresis <sup>1)</sup>	max. 40 mbar (with supply voltage: DC 20 ... 30 V) max. 80 mbar (with supply voltage: DC 18 ... 20 V)					
<sup>1)</sup> → EMC specifications (general data)						

Fig. 22

## 10.4 Product-specific data (part 2)

Type	MPPE-3-1/8-2,5-		MPPE-3-1/4-2,5-		MPPE-3-1/2-2,5-	
	010B	420B	010B	420B	010B	420B
Nominal flow rate $q_n$ 1.5 → 1.25 with $p = 4$ bar at 1	550 l/min		1390 l/min		3650 l/min	
Pressure ranges	– Permissible supply pressure: max. 6 bar – Control range: 0 ... 2.5 bar					
Hysteresis <sup>1)</sup>	max. 40 mbar (with supply voltage: DC 20 ... 30 V) max. 80 mbar (with supply voltage: DC 18 ... 20 V)					
<sup>1)</sup> → EMC specifications (general data)						

Fig. 23

Type	MPPE-3-1/8-1		MPPE-3-1/4-1		MPPE-3-1/2-1	
	010B	420B	010B	420B	010B	420B
Nominal flow rate $q_n$ 0.6 → 0.5 with $p = 2$ bar at 1	330 l/min		800 l/min		2130 l/min	
Pressure ranges	– Permissible supply pressure: max. 2 bar – Control range: 0 ... 1 bar					
Hysteresis <sup>1)</sup>	max. 30 mbar (with supply voltage: DC 20 ... 30 V) max. 60 mbar (with supply voltage: DC 18 ... 20 V)					
<sup>1)</sup> → EMC specifications (general data)						

Fig. 24

Type	MPPE-3-1/8- $p_u$ - $P_o$		MPPE-3-1/4- $p_u$ - $P_o$		MPPE-3-1/2- $p_u$ - $P_o$	
	010B	420B	010B	420B	010B	420B
Nominal flow rate $q_n$	Depending on special adaptation selected					
Pressure ranges	– Permissible supply pressure: max. ( $P_o + 1$ ) bar (at $P_o < 1$ bar) max. ( $P_o + 2$ ) bar (at $P_o > 1$ bar) – Control range: $P_u \dots P_o$ bar					
Hysteresis <sup>1)</sup>	depending on special adaptation selected (→ catalogue specifications)					
<sup>1)</sup> → EMC specifications (general data)						

Fig. 25