

Dossier Wegventielen

Dossier Wegventielen

- De verschillende ventielen

- Wegventielen

- 2/2-ventiel
- 3/2-ventiel
- 4/2-ventiel
- 5/2-ventiel
- 4/3-ventiel
- 5/3-ventiel



- Regelventielen

- Smoring
- Snelheidsregelventiel
- Snelontluchter



- Terugslagventielen

- Terugslagklep
- Gestuurde terugslagklep
- Wisselventiel (OF-functie)
- Tweedrukventiel (EN-functie)



Dossier Wegventielen

• De symbolen

- Aantal schakelstanden



- Type sturing



- Voorstelling verbindingen tussen aansluitpoorten

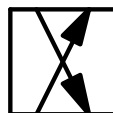

- Voorstelling afgesloten poorten

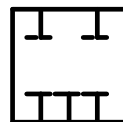

- Afgewerkt symbol :

- 3 aansluitpoorten
- 2 standen

=

- 3/2 ventiel :

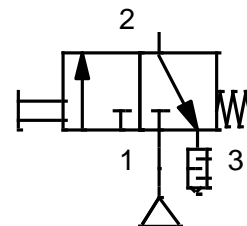

- 5/2 ventiel

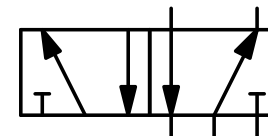

Dossier Wegventielen

- De benaming

- X=Aantal poorten zonder de sturing
- Y=Aantal standen

X/Y

- Afgewerkt symbol :

- 3/2 ventiel

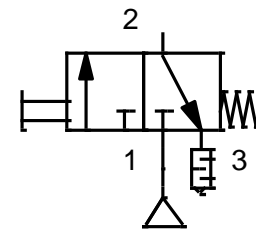

- 5/2 ventiel

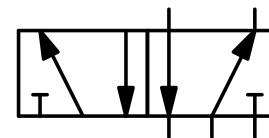





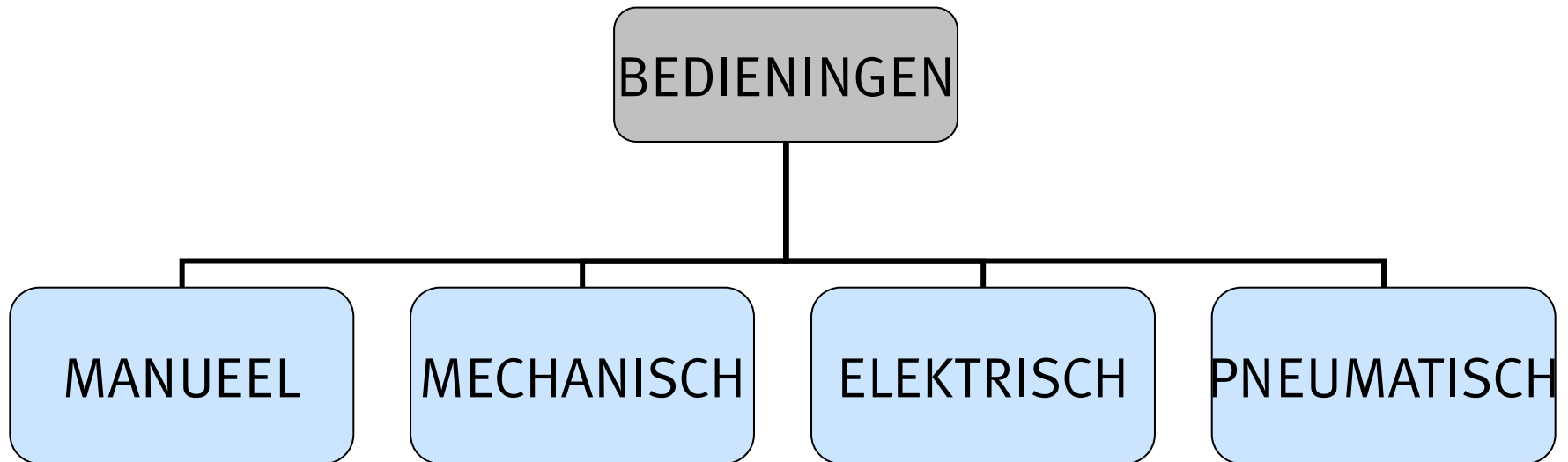



Dossier Wegventielen

- De sturingen

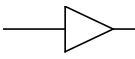

Dossier Wegventielen

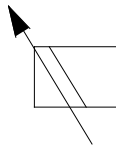
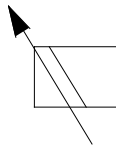
- De sturingen

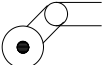
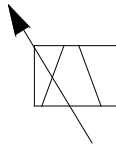
	MANUEEL	MECHANISCH	ELEKTRISCH	PNEUMATISCH
	Handbediening			
	Paddestoelknop			
	Hendel			Proportionele spoel
	Voetbediening			
	Vergrendeling			Proportionele tweerichtings-spoel

Dossier Wegventielen

- **Monostabiele en bistabiele ventielen**

- Monostabiele ventielen.
 - Retour door interne veerkracht

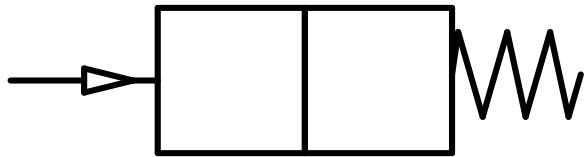

- Bistabiele ventielen
 - Retour door externe kracht

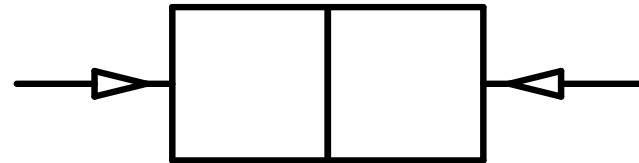

Dossier Wegventielen

- **Het 2/2 ventiel**

- Monostabiele 2/2 ventielen.

- Normaal gesloten

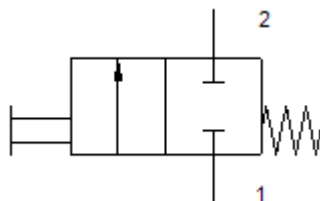

- Normaal open

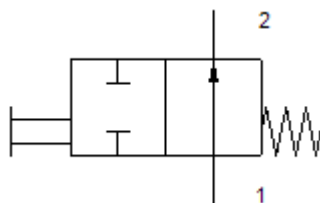

- Bistabiel 2/2 ventiel

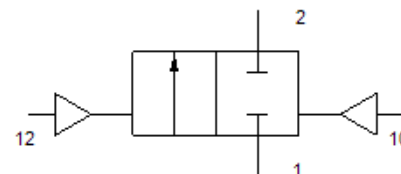

1: Aansluitpoort voor de voeding

2: Aansluitpoort voor de uitgang

12 : Stuurpoort die het ventiel opent (verbinding 1 – 2 na sturing)

10 : Stuurpoort die het ventiel sluit (verbinding 1 – 0 na sturing)

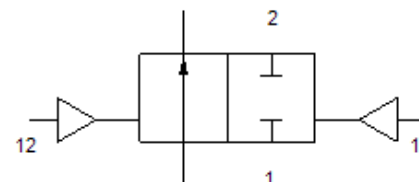

Dossier Wegventielen

- 2/2 ventielen

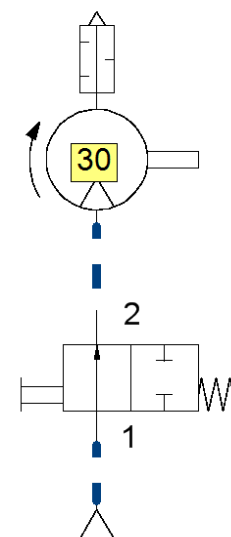
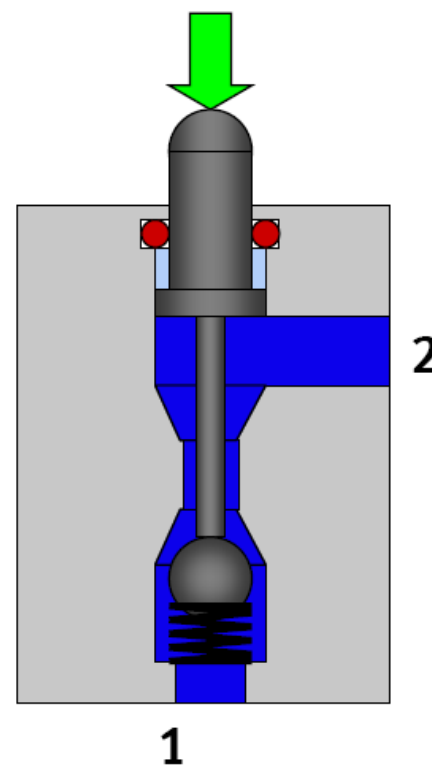
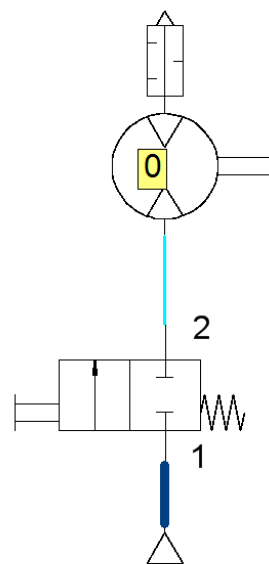
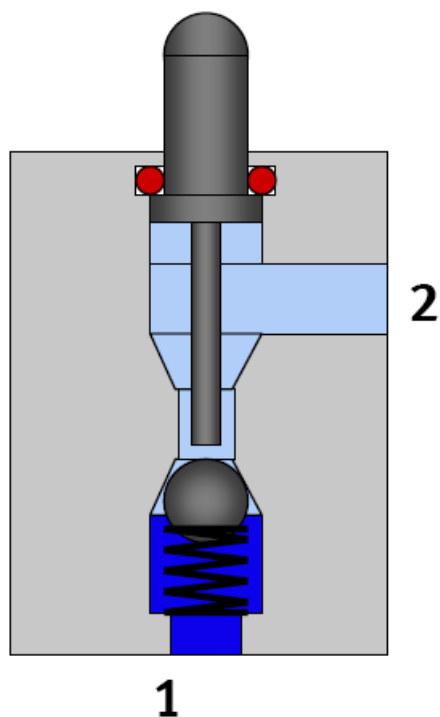

Dossier Wegventielen

- Het 3/2 ventiel

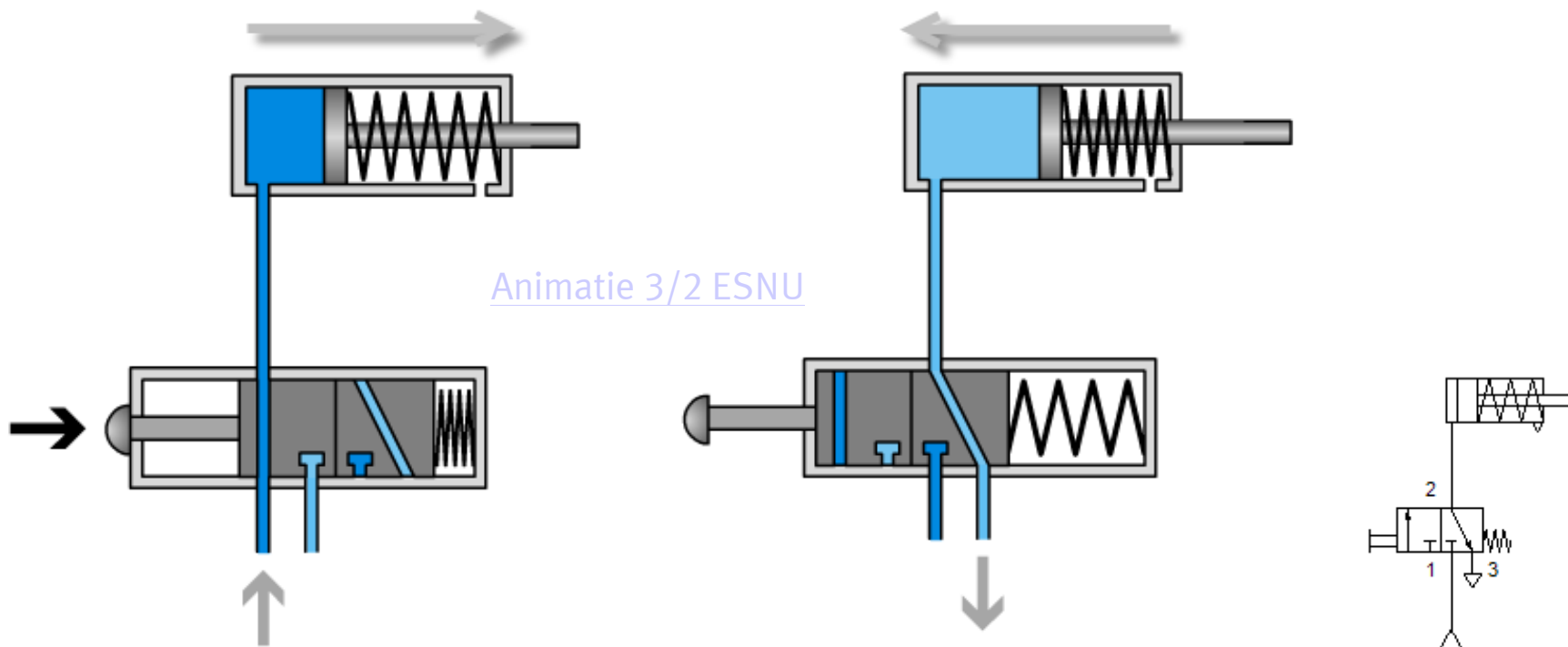

Dossier Wegventielen

• Het 3/2 ventiel

- Monostabiele 3/2 ventielen.

- Normaal gesloten

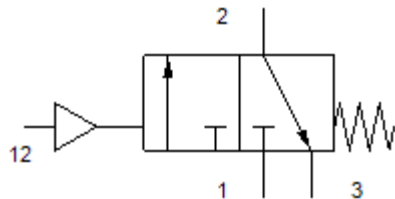

- Normaal open

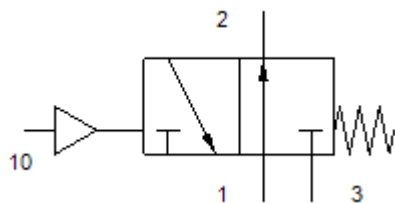

- Bistabiel 3/2 ventiel

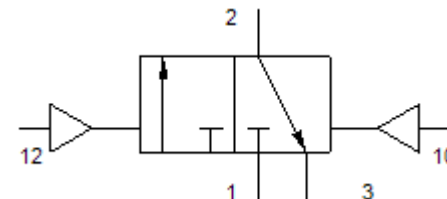

1: Aansluitpoort voor de voeding

2: Aansluitpoort voor de uitgang

3: Aansluitpoort voor de ontluchting

12 : Stuurpoort die het ventiel opent (verbinding 1 – 2 na sturing)

10 : Stuurpoort die het ventiel sluit (verbinding 1 – 0 na sturing)

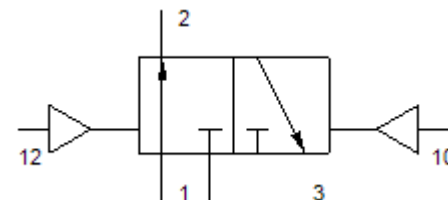

Dossier Wegventielen

- Het 3/2 ventiel

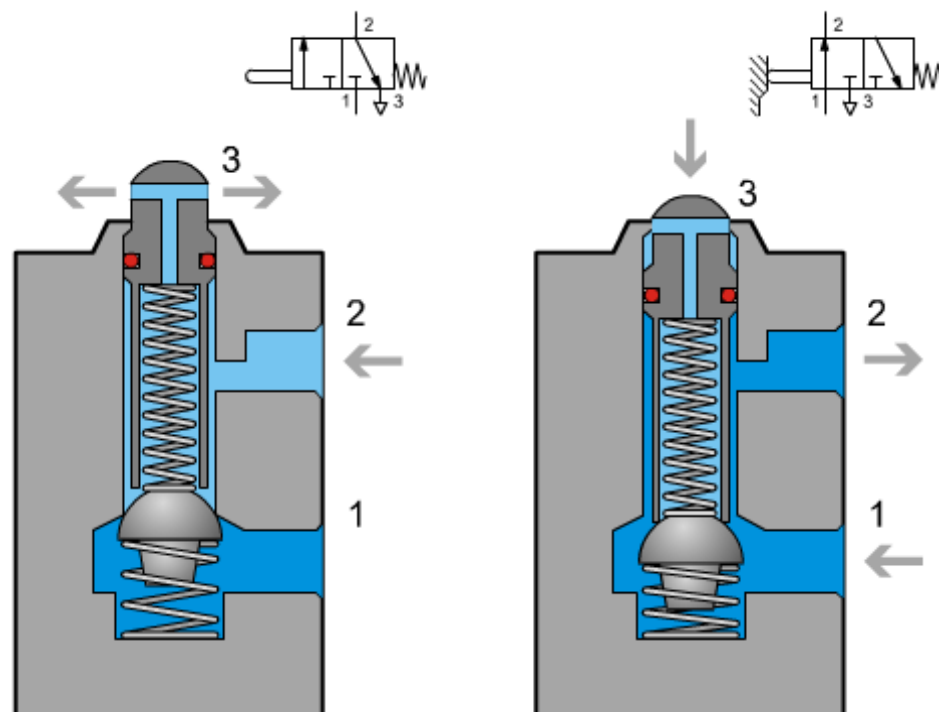

Dossier Wegventielen

• Afbeeldingen 3/2 ventielen

- Monostabiel 3/2 ventiel, luchtgestuurd - veerretour



- FESTO type [VL/O-3-1/8-B](#)
- [Documentatie](#)
- [Informatieblad](#)
- [Accessoires](#)
- [CAD](#)

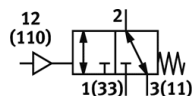

- Monostabiel 3/2 ventiel, handbediend- veerretour



- FESTO type [VHEM-PTC-M32C-M-G18](#)
- [Documentatie](#)
- [Informatieblad](#)
- [Accessoires](#)
- [CAD](#)

Dossier Wegventielen

- 4/2 en 5/2 ventielen
 - Sturing dubbelwerkende cilinder met combinatie van 2 x 3/2 ventiel.

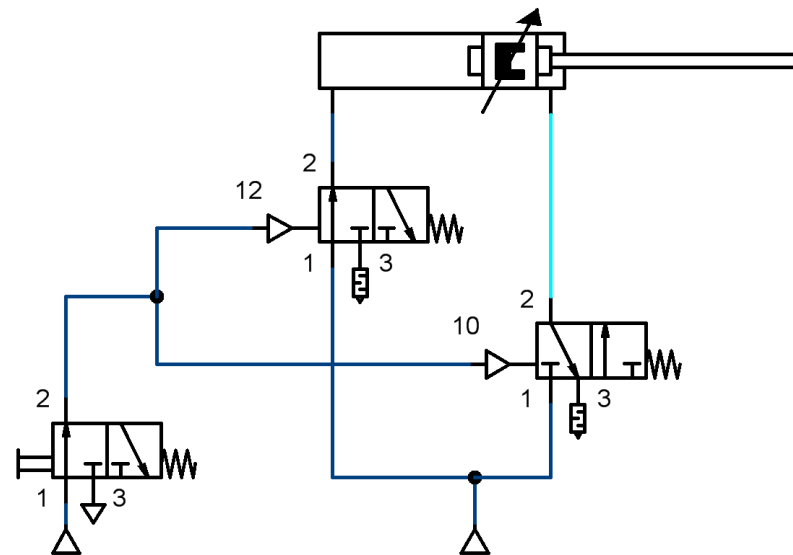
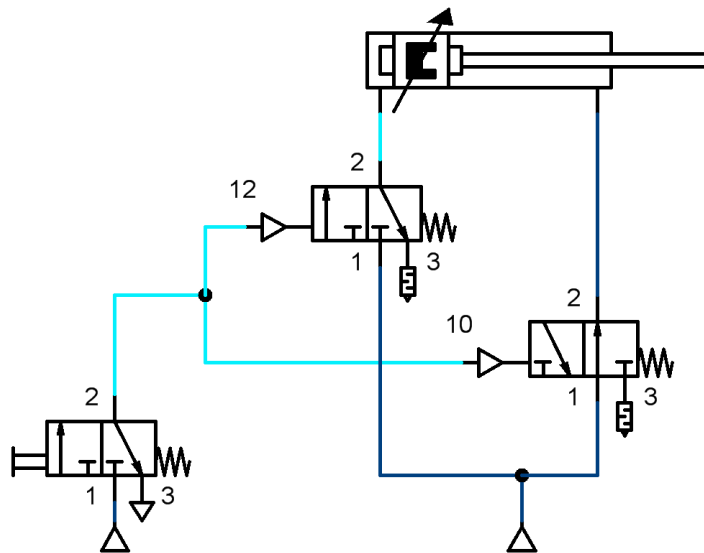

Dossier Wegventielen

- **Het 4/2 ventiel**
 - Sturing dubbelwerkende cilinder met 4/2 ventiel.

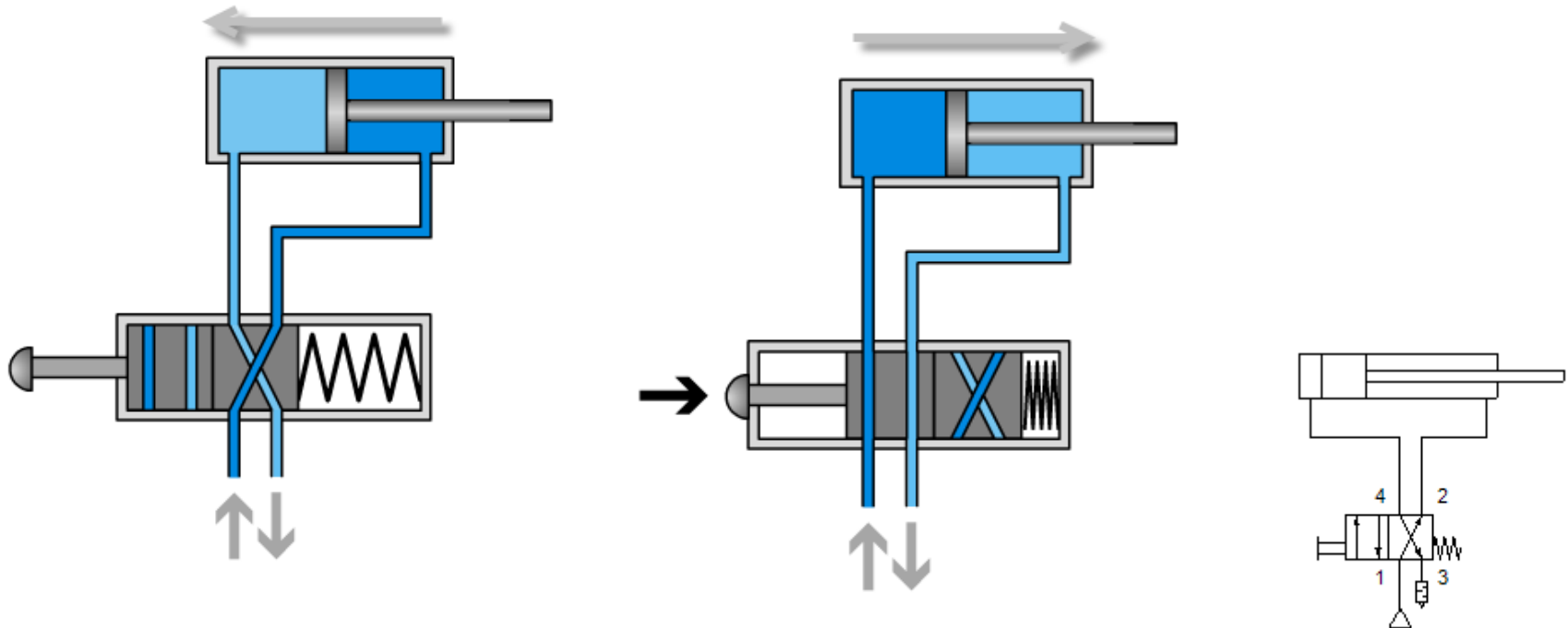

Dossier Wegventielen

- **Het 4/2 ventiel**

- Monostabiel 4/2 ventiel.

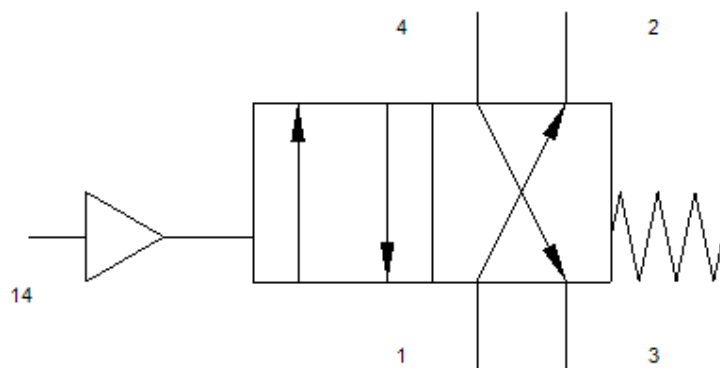

- Bistabiel 4/2 ventiel

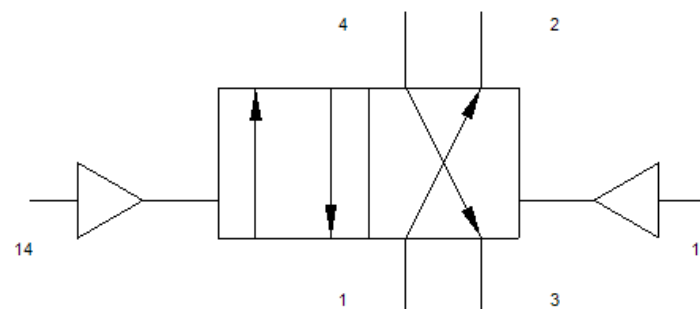

- 1: Aansluitpoort voor de voeding
- 2 en 4: Aansluitpoorten voor de uitgangen
- 3: Aansluitpoort voor de ontluchting
- 12 : Stuurpoort die verbinding 1 – 2 maakt
- 14 : Stuurpoort die verbinding 1 – 4 maakt

Dossier Wegventielen

- **Het 5/2 ventiel**

- Monostabiel 5/2 ventiel.

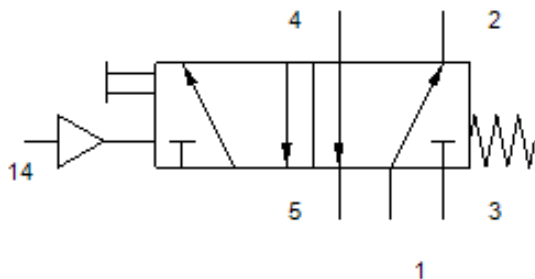

- Bistabiel 5/2 ventiel

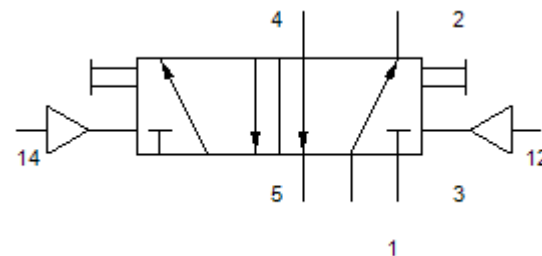

- 1: Aansluitpoort voor de voeding
- 2 en 4: Aansluitpoorten voor de uitgangen
- 3 en 5: Aansluitpoorten voor de ontluchtingen
- 12 : Stuurpoort die verbinding 1 – 2 maakt
- 14 : Stuurpoort die verbinding 1 – 4 maakt

Dossier Wegventielen

- Het 5/2 ventiel

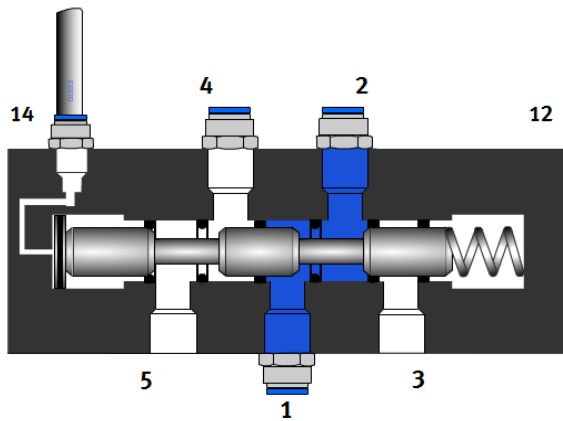

Animatie 5/2 mono

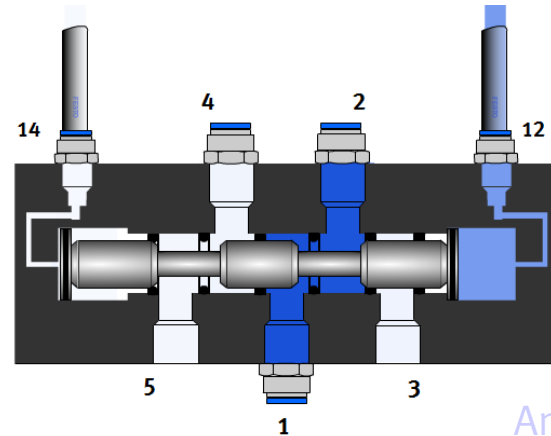

Animatie 5/2 bi

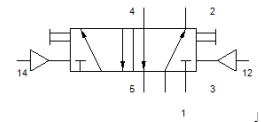
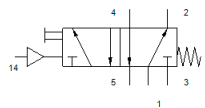
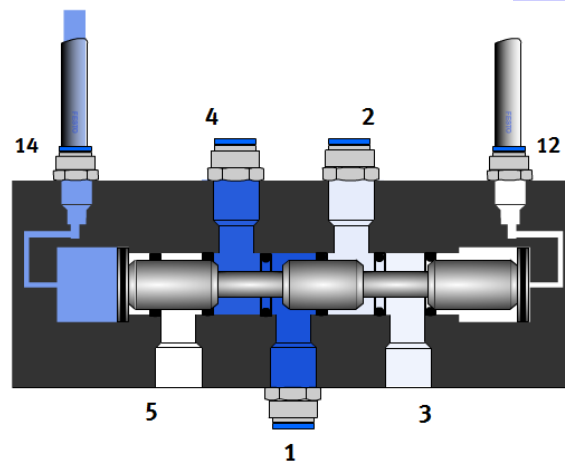

Dossier Wegventielen

- **Het 5/2 ventiel**
 - Sturing dubbelwerkende cilinder met 5/2 ventiel.

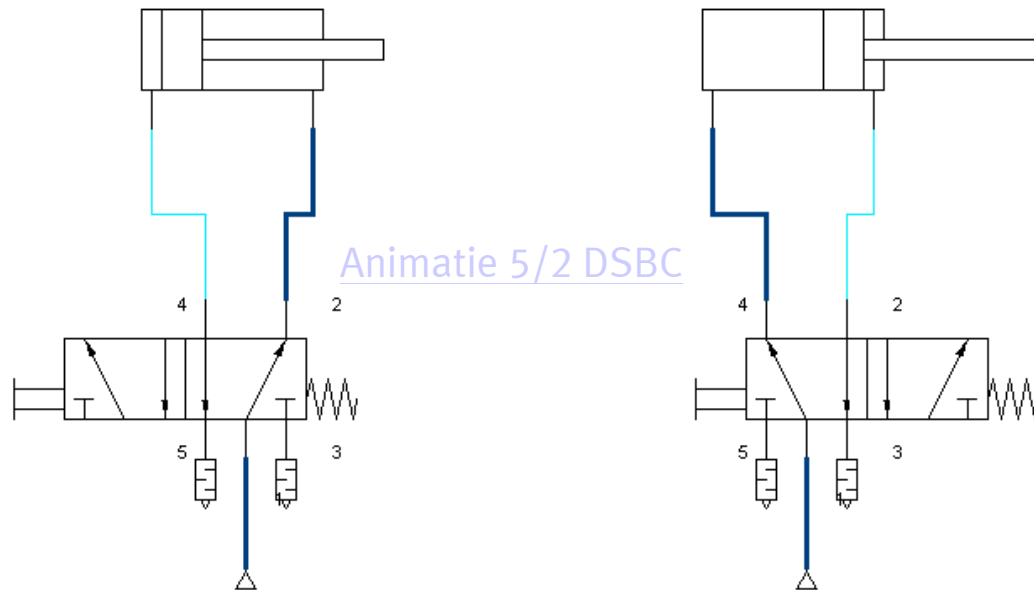

Dossier Wegventielen

• Afbeeldingen 5/2 ventielen

- Monostabiel 5/2 ventiel, hefboombediend handbediend-luchtveerretour



- FESTO type [VHEM-L-M52-A-G18](#)
- [Documentatie](#)
- [Informatieblad](#)
- [Accessoires](#)
- [CAD](#)

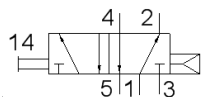

- Bistabiel 5/2 ventiel, luchtgestuurd



- FESTO type [IH-5-1/8](#)
- [Documentatie](#)
- [Informatieblad](#)
- [Accessoires](#)
- [CAD](#)

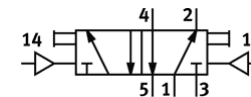

Dossier Wegventielen

- Het 4/3 ventiel

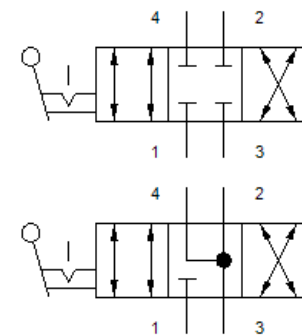
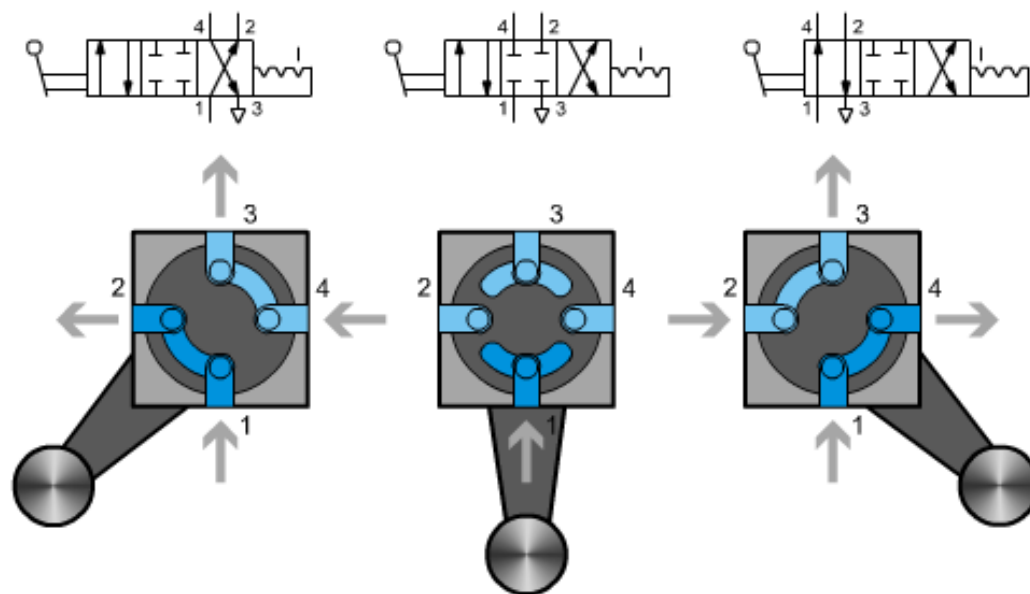

Dossier Wegventielen

- Afbeelding 4/3 ventiel

- 4/3 ventiel met 3 vaste standen, hefboombediend



- FESTO type [VHER-AH-M04C-G18-LD](#)
- [Documentatie](#)
- [Informatieblad](#)
- [Accessoires](#)
- [CAD](#)

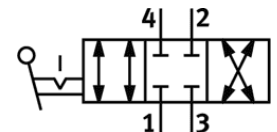

Dossier Wegventielen

- Het 5/3 ventiel

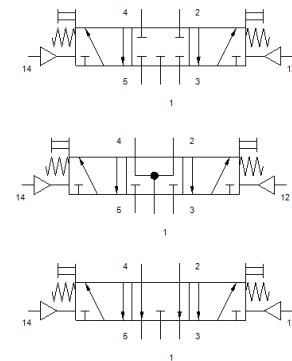
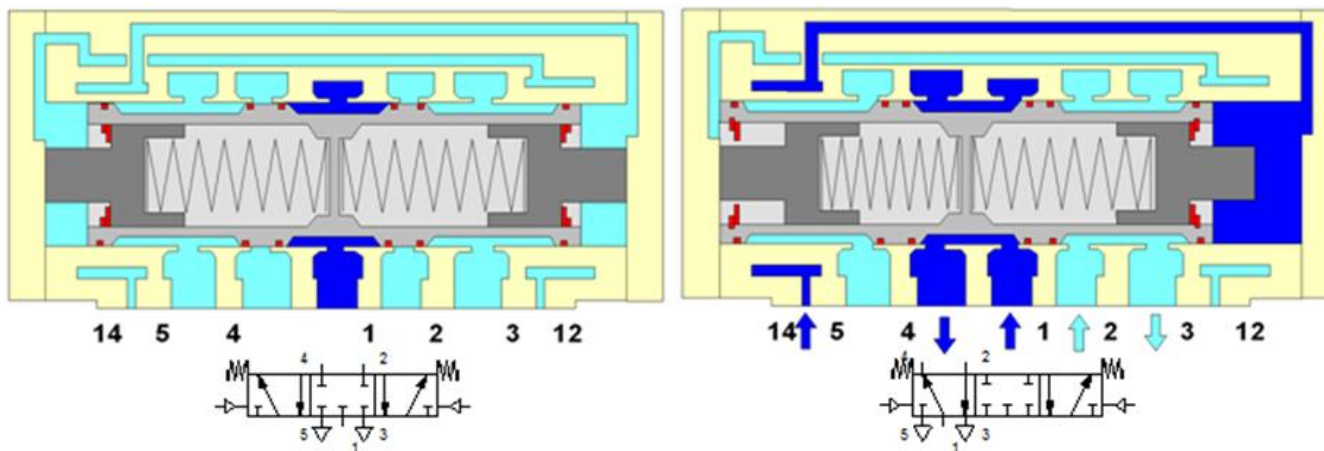

Dossier Wegventielen

- De constructie

- Klepventielen

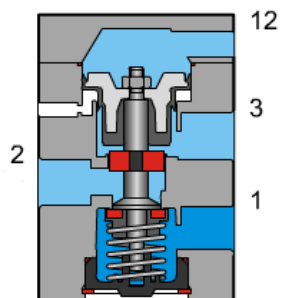
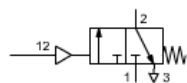

- Schuifventielen

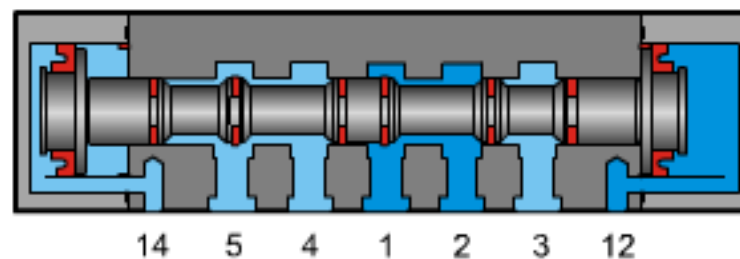
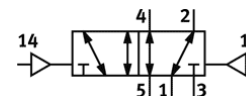

Dossier Wegventielen

- Differentieelventielen

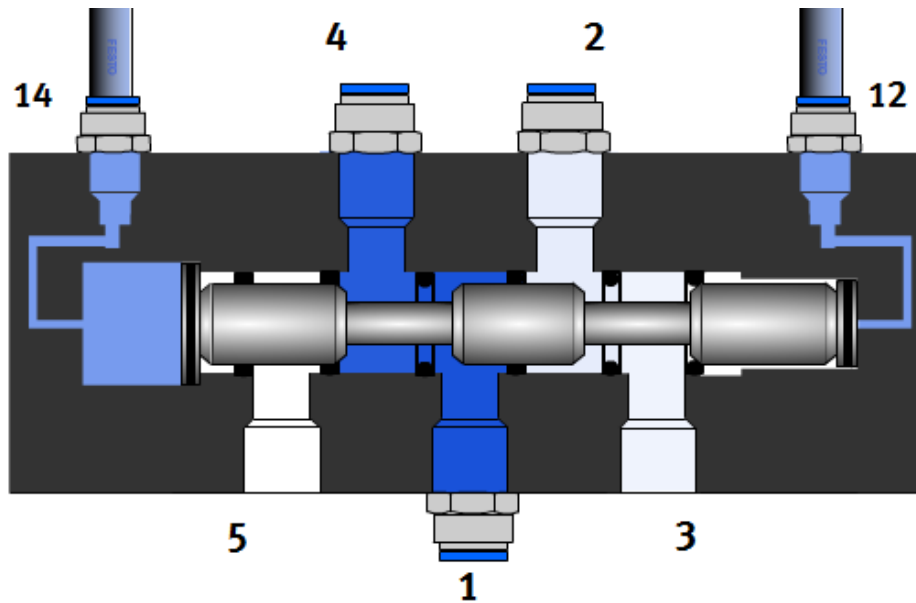

Animatie 5/2 dif

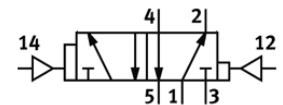

Dossier Wegventielen

- Positieve overlapping

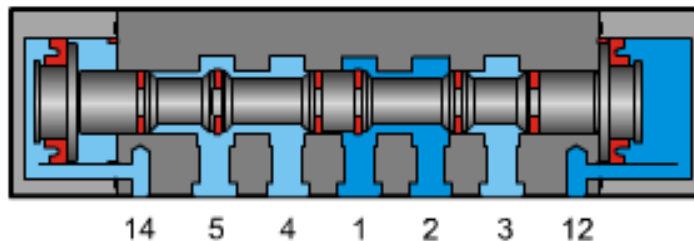

- Negatieve overlapping

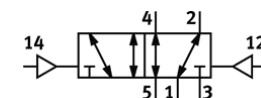
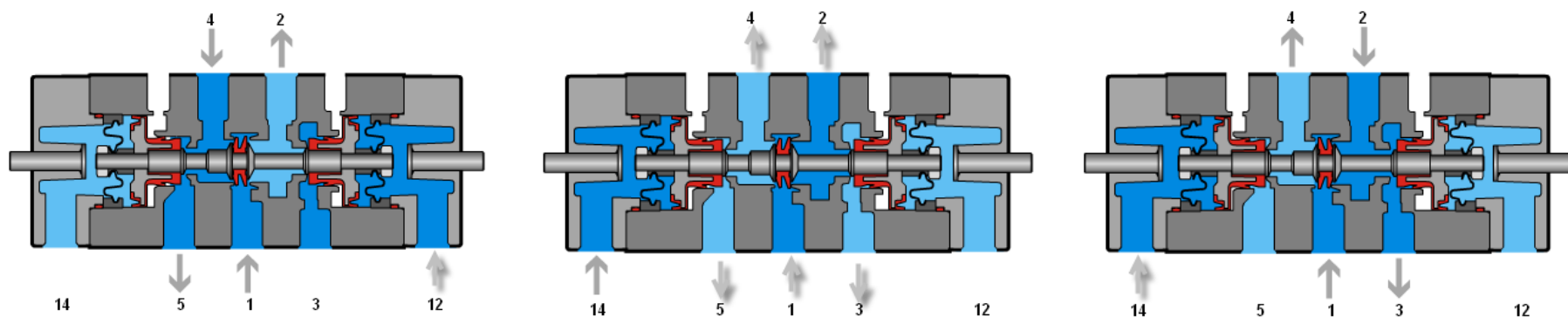

Dossier Wegventielen

- Indirect gestuurde ventielen

- 1 Stuurventiel, mechanisch gestuurd
- 2 Hoofdventiel, luchtgestuurd

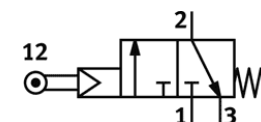
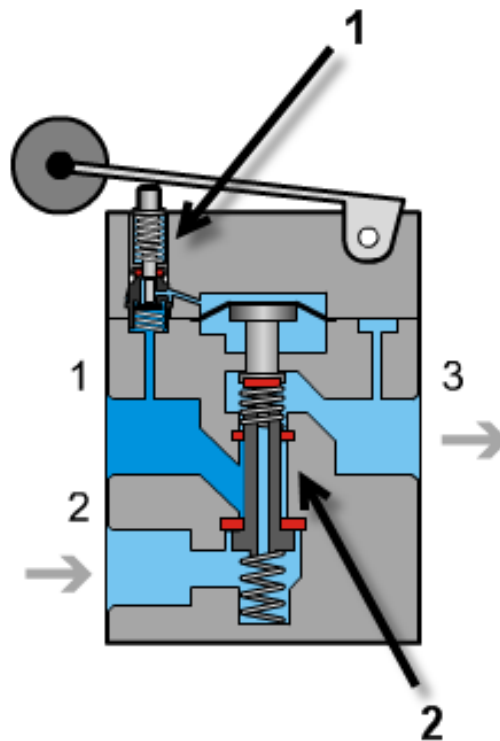
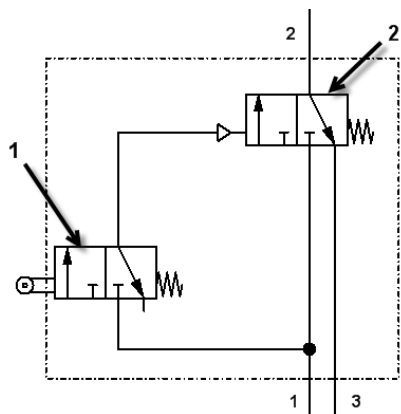

Dossier Wegventielen

• Bepalen van het debiet van een ventiel

Gegeven

- Referentiedebiet $Q_n = 800$ l/min werd bepaald bij:
- $p_1 = 0,6$ MPa
- $\Delta p = 0,1$ MPa.

Gevraagd

- *Debiet Q_n bij*
- $p_1 = 0,8$ MPa
- $\Delta p = 0,05$ MPa

