

# Basic principles of vacuum technology, brief overview

Introduction

## Basic principles of vacuum technology

What is a vacuum?	Vacuum ranges	Units of measurement
<p>A vacuum is a space entirely devoid of matter ("absolute vacuum").</p> <p>In practice we talk about a vacuum when the air pressure in a space lies below atmospheric pressure.</p>		<p>There are a large number of national and international units of measurement. The most commonly used units are Pascal (Pa) and bar</p> <p>100 Pa = 1 hPa 1 hPa = 1 mbar 1 mbar = 0.001 bar</p> <p>The vacuum level is often expressed as a % value. However, these are always relative values.</p> <p>GV = Rough vacuum FV = Medium vacuum HV = High vacuum UHV = Ultra-high vacuum</p>

## What is a vacuum used for? Measuring the pressure or vacuum Atmospheric pressure

<p>The vacuum plays a vital role in research in the fields of chemistry, biology and physics.</p> <p>It is also indispensable in many industrial processes.</p>	<p>In the rough vacuum range, the pressure gauges used are mainly mechanical, but some digital pressure gauges are also used.</p> <p>In the high and ultra-high vacuum range, highly sensitive pressure gauges are used.</p>	<p>1 Mount Everest 2 Festo 3 Sea level</p>
---	--	--

## Understanding vacuum Vacuum specification options Effects of changes on vacuum technology

<p>Air is a gas mixture with approx. <math>10^{25}</math> particles per <math>m^3</math> of air at one bar air pressure.</p> <p>Particles exert pressure or force on the walls of a defined space. The fewer particles there are in the space, the lower the force exerted on the walls.</p> <p>Pressure = <math>\frac{\text{Force}}{\text{Area}}</math></p> <p>100% vacuum would mean that there are no particles present. Pressure = 0.</p>	<p>A vacuum can be specified as an absolute value, i.e. with a positive sign from 1 to 0 bar, with 0 as absolute zero. Or it can be specified as a relative value with a negative sign from 0 to -1 bar, with 0 as a reference point, or as a %.</p>	<p>As altitude increases, the air pressure in the atmosphere falls. This same effect reduces the attainable vacuum level of an ejector. Nevertheless, the performance level of 80% remains unchanged in this case.</p>
---	--	--

# Basic principles of vacuum technology, brief overview

Introduction

Components for vacuum generation		
Vacuum ejectors	Displacement vacuum pumps	Kinetic vacuum pumps
These function according to the venturi principle, i.e. they are driven purely pneumatically and have a much simpler design compared with other vacuum generators.	Air flowing into a space is mechanically shut off, compressed and ejected. This allows a very high vacuum to be achieved at a very low flow rate.	Air is forced to flow in the delivery direction through the application of additional mechanical force. This method achieves only a relatively low vacuum level despite a high suction rate.

**Principle**

- The most important components are the jet nozzle (venturi nozzle) and at least one receiver nozzle.
- Accelerated compressed air generates a suction effect between both nozzles (vacuum).
- There are different design principles: single-stage and multi-stage ejectors.
- Depending on the principle, air is either carried away in a flow by a rotating impeller on the suction side or compressed using vaned chambers.
- The pump types available include vacuum blowers and vacuum compressors, for example.

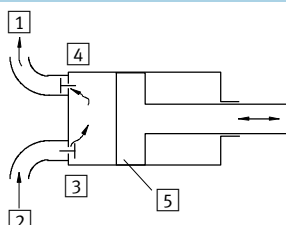

1 Pressure side  
2 Suction side  
3 Inlet valve  
4 Exhaust valve  
5 Piston

**Features**











- High vacuum level with relatively small flow rate
- Maintenance-free and wear-free
- Low-cost
- Low-weight, compact design
- Any mounting position
- High vacuum level up to  $-0.98$  bar operating pressure
- Minimal maintenance expenses
- Generally large dimensions and high weight
- Restricted mounting position
- Large flow rates, low vacuum level
- High maintenance costs

**Application**

- Wide range of applications, e.g. handling technology and process engineering.
- Broad application spectrum in industry and research.
- Used mainly for precision processes in industry.

# Basic principles of vacuum technology, brief overview

Introduction

Vacuum in handling technology			
Practical use of vacuum			Important selection factors
The extensive range of vacuum component variants makes them ideal for use in many industrial applications.	Lifting	Conveyance	<ul style="list-style-type: none"> <li>Weight, temperature, shape and roughness of the workpiece surface</li> <li>Speed per unit of time</li> <li>Stroke travel and conveying distances</li> </ul>
	 Loading	 Turning	
	 Gripping	 Machining	
	 Holding	 Insertion	
	 Feeding	 Transporting	
	 Repositioning	 Moving	

Comparison of ejectors		
Variables/criteria	Single-stage	Multi-stage
Suction flow rate	Average	High At low vacuum level up to approx. 50%
Evacuation time	Very short In higher vacuum range from 30 ... 50%	Very short In lower vacuum range up to 30 ... 50%
Initial costs	Low	Relatively high
Noise generation	Relatively high	Low

Both principles have their advantages and disadvantages which are difficult to compare. With optimally adapted

components, both principles can cover a large number of different areas of application.

Important comparison variables			
Evacuation time	Air consumption	Efficiency	Suction flow rate
Evacuation time = Time (s) required to generate a specific vacuum.	Air consumption = Air consumption (l/min) of the ejector required to generate a specific vacuum.	The efficiency formula makes it easier to compare the different principles: Efficiency = Evacuation time, air consumption and volume dependent on vacuum.	The efficiency of an ejector is often – and incorrectly – measured using the suction flow rate at 0 bar.  Suction flow rate = Suction air volume (l/min) that an ejector can draw in.

# Basic principles of vacuum technology, brief overview

Introduction

FESTO

## Vacuum in handling technology

### Energy cost comparison

To generate compressed air from atmospheric air, you need to reckon on approx. € 0.02 per m<sup>3</sup> volume at 7 bar pressure when calculating the costs involved (e.g. investment, material, labour, etc.).

Vacuum ejectors:

- High air consumption, but compensated by its energy-saving function
- Maintenance-free, no moving parts
- Low weight and component dimensions and can be installed in any mounting position
- No electrical connections required
- Relatively high vacuum level (up to 85% vacuum) attainable
- Low initial costs

Electric vacuum pumps:

- Very high vacuum (up to 99.99%) attainable
- High suction rates (vacuum blower) of up to 1,200 m<sup>3</sup>/hr. possible
- High current consumption because of continuously operated pumps
- High initial costs and ongoing maintenance costs
- Large weight and unit volume as well as fixed mounting position

For a comparison of features, a calculation example and an energy cost comparison → following sections.

## Leakage in vacuum systems

When a vacuum suction gripper cannot fully seal the system against atmospheric air, we talk about leaking systems.

This might be caused, for example, by rough and uneven workpiece surfaces or air-permeable workpiece materials.

Remedial actions to achieve the required vacuum:

- Use of high-performance ejectors
- Reduction of the suction cup diameter

## Selection aid for vacuum generators

In all cases, it is recommended that you perform a test setup to determine the leak rate, thereby enabling you to ascertain which vacuum ejector you need.

Procedure:

- Determining the leak rate
  - Perform the test setup
  - Read the vacuum value achieved
  - Compare the result with the course of the curve in the 'Suction capacity as a function of vacuum' chart (→ 28)
  - Difference with respect to suction capacity = leak rate
- Determining the correct ejector size
  - Intersection of the leak rate (now known) with the curves of other ejectors
  - Determine the attainable vacuum by means of projecting downwards from the intersections with the leak rate
- Select the ejector that reaches the required vacuum level.

# Basic principles of vacuum technology, brief overview

Introduction

## Typical applications

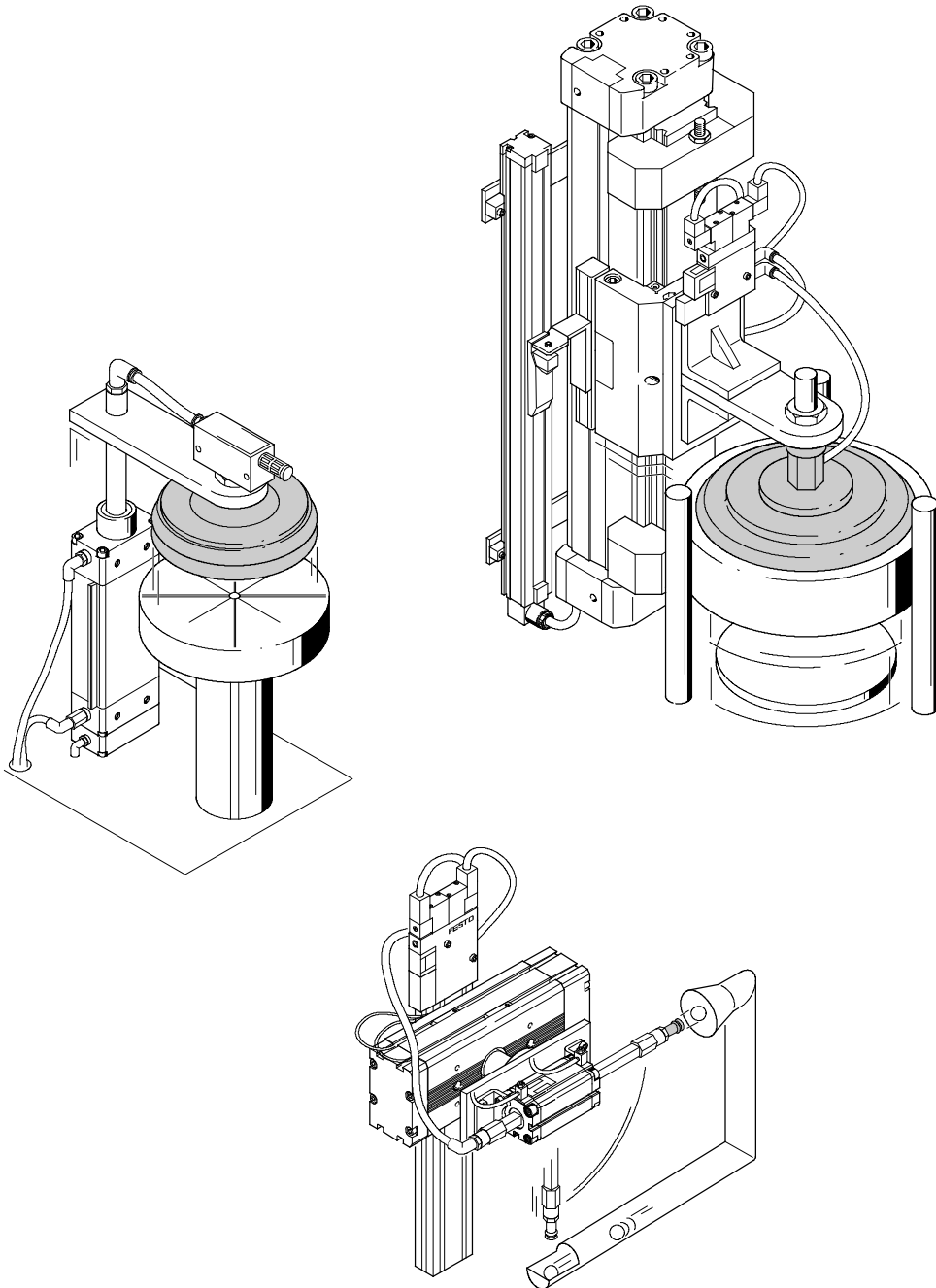

# Basic principles of vacuum technology

Introduction

## What is a vacuum?

In physics, a vacuum is defined as “a state of emptiness that can be achieved by experiment” – in other words, nothing. This definition refers to the state of a space entirely devoid of matter (sometimes also referred to as an “absolute vacuum”).

In practice, however, this state cannot be achieved. We therefore talk instead about a vacuum when the air pressure in a space is lower than the atmospheric pressure or when the density of air molecules is reduced.

Furthermore, every space contains particles of matter such as protons and electrons, as well as zero-mass particles – photons – which transport energy at the speed of light.

## What is a vacuum used for?

Since the 17th century (“Magdeburg hemispheres”) mankind has been studying vacuum. Today, we cannot imagine modern research without it.

In chemistry, reactions in substances are investigated in a vacuum, biology is interested in the effects of a vacuum on organisms, while some areas of physics (quantum physics, field theory, etc.) are concerned with particles that can be examined more accurately in a vacuum.

Today, the vacuum plays a vital role in important industrial processes, many of which would not be possible without it. Noteworthy examples include semiconductor manufacture or mass spectroscopy.

Vacuum technology has also played a part in the development and implementation of new ideas in handling technology, i.e. lifting, holding, rotating and transporting all kinds of parts.

## Understanding vacuum

Air is a gas mixture containing approx.  $10^{25}$  particles per  $m^3$  at one bar air pressure.

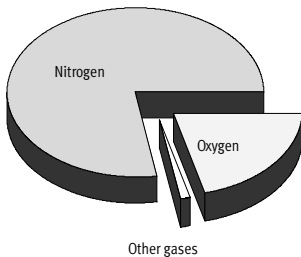

In the atmosphere, this gas mixture is made up of the following gases and proportions:

- 78% Nitrogen
- 21% Oxygen
- 1% Other gases (e.g. carbon dioxide and argon)

To attain a state of vacuum, a space must be empty, i.e. devoid of all gaseous material. The consequence of this is that the pressure in this space is very low, as it contains no or only a small number of particles, which exert a force on an area as a result of their impact against the walls.

Pressure is therefore defined as follows:

$$\text{Pressure} = \frac{\text{Force}}{\text{Area}}$$

In theory, in an absolute vacuum, i.e. where there are no more particles of matter in the space, pressure = 0.

Pressure gauge

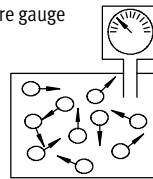

Small number of particles at constant temperature  
→ low pressure

In reality, however, this is rarely achievable. In an ultra-high vacuum, the pressure may indeed be low (approx.  $10^{-8}$  to  $10^{-11}$  mbar), but the particle number density is still approx.  $2.5 \times 10^{13}$  particles per  $m^3$ . The following rule therefore applies: **The fewer particles there are, the lower the pressure.**

Pressure gauge

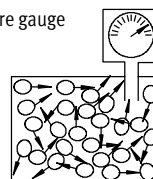

Large number of particles at constant temperature  
→ high pressure

# Basic principles of vacuum technology

Introduction

## Vacuum ranges

In practice, the large vacuum range that can technically be achieved – which now consists of more than 16 powers of ten – is generally subdivided into smaller ranges.

The vacuum ranges below are classified according to physical attributes and technical requirements.

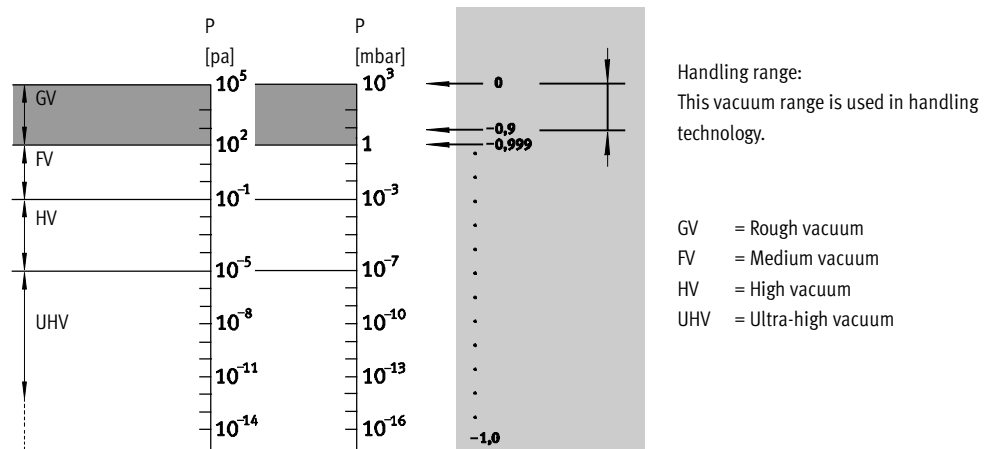

Vacuum range	Pressure range (absolute)	Applications
Rough vacuum	Atmospheric pressure ... 1 mbar	Applications in industrial handling technology. In practice, the vacuum level is often specified as a percentage, i.e. the vacuum is defined in proportion to its ambient pressure. The material and the surface finish of workpieces play a major role in vacuum applications.
Medium vacuum	$10^{-3}$ ... 1 mbar	Steel degassing, light bulb production, drying of plastics, freeze drying of foodstuffs, etc.
High vacuum	$10^{-3}$ ... $10^{-8}$ mbar	Smelting or annealing of metals, electron tube manufacture.
Ultra-high vacuum	$10^{-8}$ ... $10^{-11}$ mbar	Spraying of metals, vacuum metallizing (coating of metals) as well as electron beam melting.

## Measuring the pressure or vacuum

Pressure is defined as the force per unit area. Air is a gas mixture made up of many particles (atoms and molecules). These particles are in continuous motion. Wherever they meet, they exert a force.

The pressure and vacuum are measured by taking a specific unit area and measuring the number and intensity of this impact on this area. Measurements are necessary in order to be able to check and monitor processes.



For this reason, all measuring instruments must be “calibrated”, i.e. individual measuring instruments with the same function must be adjusted so that they produce the same result under the same conditions.

In order to be able to evaluate or measure the vacuum medium, there are a number of items of technical equipment that are indispensable for applications in the fields of industry and research.

Pressure gauges (vacuum gauges) are used generally as well as in the rough vacuum range. These gauges are scaled according to the level of accuracy required. Pressure gauges work according to many different operating principles and can function mechanically or digitally.

The most common mechanical function types are:

- Bourdon tube pressure gauge
- Aneroid pressure gauge
- Diaphragm pressure gauge
- Digital pressure gauge

In the high and ultra-high vacuum range, pressure gauges with highly sensitive response mechanisms are used. A great many additional factors play a role in determining the measurement results in this case.

It is important to remember that there are two different options for specifying or representing the same measurement result.

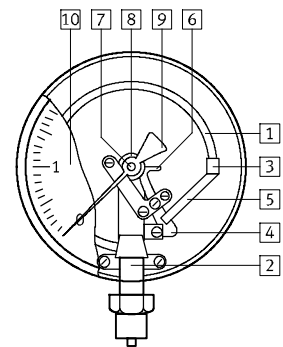

- 1 Bourdon tube
- 2 Spring support
- 3 Spring end piece
- 4 Segment
- 5 Tie rod
- 6 Gearing
- 7 Indicator shaft
- 8 Coil spring
- 9 Indicator
- 10 Dial face

# Basic principles of vacuum technology

Introduction

## Vacuum designations and specification options

It is important to mention at this point that there a number of different designations for the term vacuum in both colloquial and technical language. In order to avoid any uncertainty or misunderstanding, these designations need to be explained here.

### Vacuum

Correct designation – specified as % only in the range 0 ... 1 bar absolute pressure.

Operating pressure	Vacuum as an absolute value	Vacuum as a relative value
<p>Correct designation, operating pressure of 0 bar relative pressure is equivalent to 1 bar absolute pressure. A vacuum is generally specified as relative operating pressure, i.e. with a negative sign.</p> <p>Operating pressure can be specified correctly in two different ways, i.e. as a relative or an absolute value. Both specification options are also applied to vacuums and are explained in more detail below.</p>	<p>Applications: In the field of science as well as in the medium-high and high vacuum ranges.</p> <p>Principle: Vacuum is specified as an absolute value in proportion to absolute zero, i.e. 0 bar is the lowest value and corresponds to 100% vacuum. In the vacuum range, 1 bar is thus the highest value and corresponds to the average ambient pressure.</p> <p>Feature: Vacuum values have positive signs. Vacuum range 1 ... 0 bar</p>	<p>Applications: In the rough or operating vacuum range (e.g. for Festo applications).</p> <p>Principle: Vacuum is specified as a relative value in proportion to ambient pressure, i.e. the specified vacuum value has a negative sign, because the ambient pressure (atmospheric pressure) has been assumed as the reference point with a value of 0. The lowest value, i.e. also 100% vacuum corresponds to –1 bar relative operating pressure.</p> <p>Feature: Vacuum values have negative signs. Vacuum range 0...-1 bar</p>

### Specification options for the pressure or vacuum

Operating pressure [bar]	Vacuum [%]	Absolute pressure [bar]
6	–	7
5		6
4		5
3		4
2		3
1		2
0	0	1
–0.1	10	0.9
–0.2	20	0.8
–0.3	30	0.7
–0.4	40	0.6
–0.5	50	0.5
–0.6	60	0.4
–0.7	70	0.3
–0.8	80	0.2
–0.85	85	0.15
–0.9	90	0.1
–0.95	95	0.05
–1	100	0



# Basic principles of vacuum technology

Introduction

## Units of measurement

As already described in the section “Designations and specification options”, there are two ways of representing a vacuum:

- As a pressure unit (relative or absolute)
- As a percentage

There are a large number of national and international units of measurement in common use that can be used to specify a vacuum as a pressure unit.

These units of measurement are listed in the conversion table (international vacuum/pressure conversion table) below.

It should be mentioned here that the current official unit of measurement for the vacuum is the pascal (Pa). However, this is rarely used in practice. In reality, the preferred units of measurement are bar, mbar or %, particularly in the rough vacuum range (e.g. handling technology). In the following pages also, only the units of measurement bar and % are used.

Vacuum specifications that use bar as the unit of measurement are always considered as relative values (described under “Vacuum as a relative value”).

The most commonly used pressure units bear the following ratios to one another:

$$\begin{aligned} 100 \text{ Pa} &= 1 \text{ hPa} \\ 1 \text{ hPa} &= 1 \text{ mbar} \\ 1 \text{ mbar} &= 0.001 \text{ bar} \end{aligned}$$

For the sake of simplicity, vacuum is generally expressed as a percentage in the range 0 to 100%.

This is always a relative value. The conversion tables (international vacuum/pressure conversion tables) below are a useful aid for expressing these values relative to the other units of measurement.

International vacuum/pressure conversion table

Unit	bar	N/cm <sup>2</sup>	kPa	atm, kp/cm <sup>2</sup>	m H <sub>2</sub> O	torr, mm Hg	in Hg	psi
bar	1	10	100	1.0197	1.0197	750.06	29.54	14.5
N/cm <sup>2</sup>	0.1	1	10	0.1019	0.1019	75.006	2.954	1.45
kPa	0.01	0.1	1	0.0102	0.0102	7.5006	0.2954	0.145
atm, kp/cm <sup>2</sup>	0.9807	9.807	98.07	1	1	735.56	28.97	14.22
m H <sub>2</sub> O	0.9807	9.807	98.07	1	1	735.56	28.97	14.22
torr, mm Hg	0.00133	0.01333	0.1333	0.00136	0.00136	1	0.0394	0.0193
in Hg	0.0338	0.3385	3.885	0.03446	0.03446	25.35	1	0.49
psi	0.0689	0.6896	6.896	0.0703	0.0703	51.68	2.035	1

International vacuum/pressure conversion table with absolute and relative value comparison

Relative vacuum [%]	Residual pressure, absolute [bar]	Pressure, relative [bar]	N/cm <sup>2</sup>	kPa	atm, kp/cm <sup>2</sup>	m H <sub>2</sub> O	torr, mm Hg	in Hg
10	0.9	-0.101	-1.01	-10.1	-0.103	-0.103	-76	-3
20	0.8	-0.203	-2.03	-20.3	-0.207	-0.207	-152	-6
30	0.7	-0.304	-3.04	-30.4	-0.31	-0.31	-228	-9
40	0.6	-0.405	-4.05	-40.5	-0.413	-0.413	-304	-12
50	0.5	-0.507	-5.07	-50.7	-0.517	-0.517	-380	-15
60	0.4	-0.608	-6.08	-60.8	-0.62	-0.62	-456	-18
70	0.3	-0.709	-7.09	-70.9	-0.723	-0.723	-532	-21
80	0.2	-0.811	-8.11	-81.1	-0.827	-0.827	-608	-24
90	0.1	-0.912	-9.12	-91.2	-0.93	-0.93	-684	-27

# Basic principles of vacuum technology

Introduction

## Atmospheric air pressure

### Definition

Our planet – which includes us as well as everything on the earth’s surface – is surrounded by a layer of air several kilometres thick. This layer of air is known as the earth’s atmosphere or, more simply, the atmosphere. Gravity causes the weight of this mass of air to exert pressure on the earth’s surface.

The pressure generated is known as atmospheric pressure or air pressure.

Our atmospheric conditions can also be compared with conditions under water. We live at the bottom of a “sea of air”.

The gravitational force of the air above us generates pressure which we call air pressure.

At present, the official unit of measurement for air pressure is hPa. This abbreviation stands for hectopascal (1 hPa = 1 mbar).

On average, the air pressure at sea level is 1,013.25 mbar. If we imagine an air column with a cross-section area of 1 m<sup>2</sup>, which extends from the earth’s surface (sea level) to the outermost edge of the atmosphere, the air exerts pressure on this 1 m<sup>2</sup> of the earth’s surface with a mass of 10,000 kg approx.

 Note

NASA describes an altitude of approx. 120 km above the earth’s surface as the outermost edge of the atmosphere. Air molecules can, however, be found at much greater altitudes. It is therefore impossible to definitively identify the “edge” of the atmosphere.

If, starting at sea level, we now begin to climb higher, this imaginary air column becomes shorter and the air mass is reduced. Because the air pressure falls as the air mass decreases, we can conclude that atmospheric air pressure falls as altitude increases. This is why we say that “the air is getting thinner”.

Air pressure dependent on altitude can be calculated using the Boltzmann barometric equation. This calculation is affected by a wide variety of factors.

In order to achieve accurate results, it is important to consider not only the output altitude, but also factors such as local gravitational force, atmospheric density and temperature.

To make things simpler, the air temperature and mass are considered as constants when deriving the formula.

In the derivation of the formula, the density of the layer of air ( $\rho$ ) as well as the pressure at the earth’s surface ( $p_{(h=0)}$ ) are based on assumptions from empirical values.

These courses of action and simplification of the formula derivation are an idealisation.

$$p(h) = p_{(h=0)} \exp\left\{\frac{-\rho \times gh}{p_{(h=0)}}\right\}$$

$p(h)$  = Air pressure dependent on altitude

$p_{(h=0)}$  = Pressure at the earth’s surface (1.013 bar)

$\rho$  = Density of the layer of air (1.29 kg/m<sup>3</sup>)

$h$  = Altitude

$g$  = Acceleration due to gravity

### Generally applicable statements

- At sea level, atmospheric pressure is approx. 1,013 mbar.
- By 2,000 m above sea level, the pressure has fallen by approx. 1% per 100 m to 763 mbar.
- At approx. 5,500 m, the pressure is only 50% of the value at sea level.
- At the summit of Mount Everest (8,848 m), atmospheric pressure is only 330 mbar.
- At an altitude of 16,000 m the pressure is 90 mbar, while it is 15 mbar at 30,000 m and approx. 8 mbar at 50,000 m.

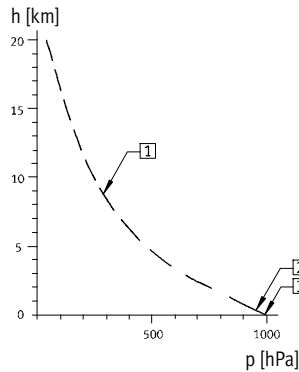

- 1 Mount Everest
- 2 Festo
- 3 Sea level

# Basic principles of vacuum technology

Introduction

## Effect of changes in air pressure on vacuum technology

The pressure drop that occurs with increasing altitude does, of course, have an effect on vacuum technology or even on the vacuum generators themselves.

Because the air pressure in the atmosphere falls with increasing altitude, the maximum attainable differential pressure and, consequently, the maximum attainable holding force of a vacuum suction gripper are also reduced. In other words, the attainable vacuum level of a vacuum ejector reduces with increasing altitude. Nevertheless, the performance level of 80% vacuum, for example, remains unchanged (→ Figure on right).

As described earlier, air pressure at sea level (0 m) is approx. 1,013 mbar. At sea level, a vacuum generator with a performance level of 80% vacuum achieves absolute pressure of approx. 0.2 bar (200 mbar).

This air pressure falls with increasing altitude. Up to a height of 2,000 m, there is a linear drop in pressure by approx. 12.5 mbar per 100 m to 763 mbar.

However, although the same vacuum generator still has the same performance level of 80% vacuum, this figure of 80% refers to the ambient pressure that has fallen to 763 mbar because of the increase in altitude. This vacuum generator can therefore only achieve a maximum absolute pressure of approx.

0.4026 bar (402.6 mbar).

Assuming that we take the same vacuum generator and go higher than the previous 2,000 m above sea level in order to generate or use a vacuum, the maximum attainable vacuum level would continue to fall while the performance level would remain unchanged at 80% because the ambient pressure in the atmosphere continues to drop.

At a height of approx. 5,500 m above sea level, the air pressure is only approx. 50% of the pressure value at sea level (506 mbar).

The possible holding force of a vacuum suction gripper falls proportionally with the attainable vacuum value.

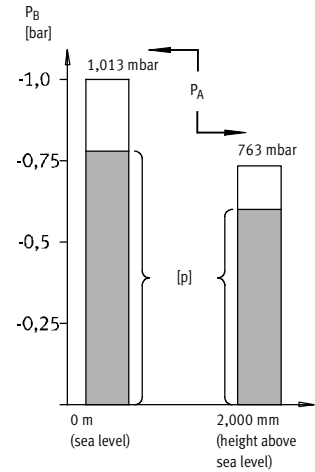

p = Performance of vacuum generator X = 80%

## Valid standards and guidelines

In accordance with Festo standard FN 942 011, the standards and guidelines have been defined for the vacuum range.

Vacuum:

All vacuum generators based on this standard that are covered in this system description operate exclusively in the rough vacuum range. In accordance with the Festo guideline, the average air pressure at sea level (1,013.25 mbar) must always be taken as the reference value when specifying and calculating pressure values.

Scaling factor:

When measuring characteristics (air consumption, pressure, evacuation time and suction capacity), fluctuations in the ambient pressure must be taken into account. Given that all pressure values measured in the research laboratory are relative pressure values referring to the current ambient pressure, the fluctuations in ambient pressure result in a degree of dispersion in the

measurement results.

The measurement results are therefore related to the reference pressure. They are converted using a scaling factor (S), which is calculated on the basis of the following equation.

$$S = \frac{p_{ref}}{p_{amb}}$$

(p<sub>ref</sub> = 1,013 mbar)

Example:

A current air pressure p<sub>amb</sub> = 975 mbar produces a scaling factor S = 1.039. The required vacuum is therefore produced at a measured value of 750 bar (0.75 mbar) absolute to P = 780 bar (0.78 mbar).

## DIN standards, research reports and Festo guidelines

DIN 1 314  
Pressure, basic definitions and units

DIN 28 401  
Graphical symbols (summary)

FB 190  
Vacuum Guideline – Basic Principles (Research Report, Festo Research, Dr. Berger)

FR 970 003  
Fluid Units and Variables

DIN 28 400  
Vacuum technology  
Part 1 General terms  
Part 2 Vacuum pumps  
Part 3 Vacuum gauges  
Part 8 Vacuum systems, components

DIN 28 402  
Quantities, symbols and units (summary)

FR 970 004  
Flow Rate Measurement

# Basic principles of vacuum technology

Introduction

## Vacuum generator

<p>Generating a vacuum in a closed space means dropping the air or gas pressure. To do this, the gas particles must either be removed or reduced in quantity.</p> <p>There are basically two ways of doing this:</p>	<ol style="list-style-type: none"> <li>1. The gas is evacuated from the closed space into an external space or into the atmosphere.</li> <li>2. The gas is combined within the vacuum system, i.e. condensed, absorbed or chemically combined.</li> </ol>	<p>The range of vacuum generators is very extensive. All work according to different technical principles and methods and are often categorised under the umbrella term “vacuum pumps”.</p> <p>We need to categorise the vacuum generators into three types here and classify them according to their mode of operation:</p> <ul style="list-style-type: none"> <li>• Vacuum ejectors,</li> <li>• Gas-absorbing vacuum pumps,</li> <li>• Gas-feeding vacuum pumps.</li> </ul>	<p>A direct comparison of these vacuum generators would not be objective enough, as they differ fundamentally from one another in terms of their technical construction, their mode of operation, their ranges of application and their efficiency.</p> <p>In this section we will describe the various types of vacuum generator referred to here based on their functionality and focus on their technical features and benefits.</p>
--	---	---	---

## Vacuum ejector – High vacuum, relatively low flow rate

<p>Compared with the often highly complex and unwieldy mechanical designs used to generate a vacuum, the operating principle of ejectors is extremely simple. Yet despite its simplicity, this principle offers enormous potential as an extremely practical solution.</p>	<p>Vacuum ejectors basically function according to the venturi nozzle principle, i.e. the vacuum is generated using pneumatically driven nozzles without moving parts.</p> <p>Vacuum ejectors are characterised by their ability to generate a high vacuum</p>	<p>or low pressure with a relatively low flow rate.</p> <p>They operate according to two different design principles using very different, often complex equipment such as valves, filters, silencers, switches, etc. However, the crucial element that</p>	<p>they have in common is the fact that the venturi principle is applied wherever the vacuum is generated.</p>
--	--	---	--

### Function principle

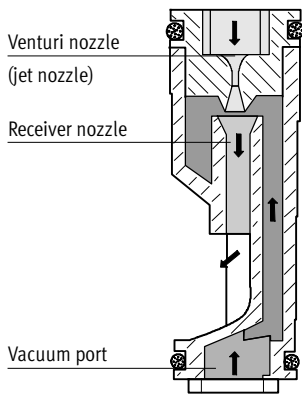
<p>A classic ejector consists of a jet nozzle (venturi nozzle) and, depending on the design principle, at least one receiver nozzle.</p> <p>Compressed air enters the ejector. The narrowing of the jet nozzle (venturi</p>	<p>nozzle) accelerates the air to up to 5 times the speed of sound as it flows through the jet nozzle.</p> <p>There is a short gap between the exit from the jet nozzle and the entry in the receiver nozzle. The expanded</p>	<p>compressed air from the jet nozzle creates a suction effect at the gap to the receiver nozzle, which in turn creates a vacuum at the output (vacuum port).</p>	<p>Single-stage ejector</p>  <p>Venturi nozzle (jet nozzle)</p> <p>Receiver nozzle</p> <p>Vacuum port</p>
---	--	---	--

# Basic principles of vacuum technology

Introduction

FESTO

## Vacuum ejector – High vacuum, relatively low flow rate

### Design principles

#### Single-stage ejector:

The design principle for a single-stage ejector includes a jet nozzle and only one receiver nozzle. After exiting the receiver nozzle, the exhaust air is generally discharged via a silencer or directly into the atmosphere.

#### Multi-stage ejector:

This design principle also includes a jet nozzle. Behind the first receiver nozzle there are additional nozzle stages, each of which has a bigger nozzle diameter in proportion to the

falling air pressure. The drawn-in air from the first chamber, combined with the compressed air from the jet nozzle, is thus used as a propulsion jet for the other chambers.

Again, the air is generally discharged via a silencer at the end of the last receiver nozzle.

### Features

- Completely maintenance-free and wear-resistant because there are no moving parts
- Low initial costs
- Low energy costs, as the ejector is only switched on when in use
- No heat build-up
- Compact design, smallest possible dimensions
- Suitable for pulsed applications
- Fast reacting
- Small line lengths between vacuum generation and application
- Easy to install, can assume any mounting position
- Low weight
- Multiple functions possible in a single device
- Dry and filtered compressed air is useful
- Supply port 4 ... 6 bar optimal

### Applications

- Part feeding systems in the automotive industry
- Packaging industry
- Industrial robot applications in all sectors
- Process engineering
- Transport of liquids and bulk material

# Basic principles of vacuum technology

Introduction

## Displacement/kinetic vacuum pumps

### General

Another component for generating a vacuum is the vacuum pump.

In order to come up with a useful classification of the pump designs and operating principles used in vacuum technology, it is best to subdivide them according to their method of operation.

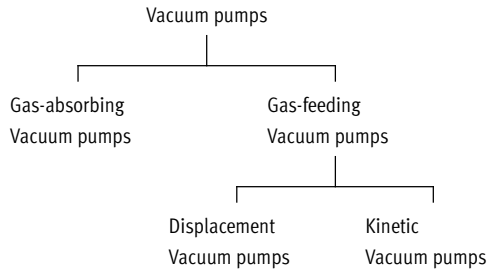

## Gas-absorbing vacuum pumps

### Function principle

As their name suggests, gas-absorbing vacuum pumps do not discharge the gas particles, but instead convert

them into a liquid, solid or sorptive state within the vacuum system. In this way, the volume of gas (air) in the

closed space is reduced and a vacuum is created.

## Gas-feeding displacement vacuum pumps – High vacuum, low flow rate

### Function principle

In displacement vacuum pumps, the gas (air) freely enters an expanding space, and is then mechanically shut off, compressed and ejected. The main feature of vacuum pumps of this type is the fact that they can achieve a very high vacuum with very low flow rates.

The figure on the right is a simplified illustration of how the principle of a displacement vacuum pump works. Although there is a wide range of solutions with varying designs, the operating principle of all pumps is the same.

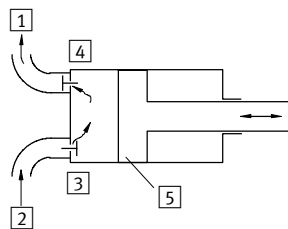

- 1 Pressure side
- 2 Suction side
- 3 Inlet valve
- 4 Exhaust valve
- 5 Piston

### Features

- High vacuum level of up to 98% attainable
- Minimal maintenance expenses
- Generally restricted mounting positions
- Larger dimensions

### Applications

- Packing machines
- Manual vacuum handling
- Clamping devices
- Research

# Basic principles of vacuum technology

Introduction

## Gas-feeding kinetic vacuum pumps – Low vacuum, high flow rate

### Function principle

With kinetic vacuum pumps, the gas particles (air) are forced to flow in the delivery direction through the application of additional force during evacuation.

The main feature of these vacuum pumps is that only a relatively low vacuum can be generated. However, they do achieve very high flow rates (high suction capacity) at the same time.

Vacuum blowers are categorised as kinetic vacuum pumps.

These vacuum generators operate according to the impulse principle, i.e. during the transfer of kinetic energy to the air by a rotating impeller **1**, the air is drawn in and compressed **4** on the suction side **2** by the blades **3** on the impeller.

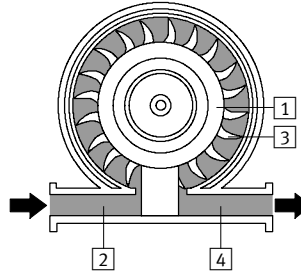

Vacuum compressors are another type of kinetic vacuum pump with similar features.

The drawn-in air is compressed in the vaned chambers of an impeller in multiple stages with low pulsation by means of centrifugal force. As with the blower, high suction rates can be achieved here with limited vacuum performance.

### Features

Vacuum blowers and compressors

- Large volumes extracted in a very short time
- High maintenance costs
- Only low vacuum performance possible

### Applications

Vacuum blowers

- Handling of extremely porous materials such as clamping plates or cardboard boxes, etc.
- Where large suction rates per unit of time are important

Compressors

- For precision industrial applications

# Basic principles of vacuum technology

Introduction

FESTO

## Practical use of vacuum

Handling is a subfunction of material flow and is subdivided into the areas of storing, changing quantities, moving, securing and checking. Handling requires the availability of specific geometric bodies (component parts or assemblies). Among the equipment used in handling

technology are feed technology components and systems, pick-and-place devices, manipulators and robots.

The way in which parts are handled has a major influence on productivity in automated production and

assembly processes today.

Vacuum technology is now an important part of this handling technology and has become indispensable in many of the industries and fields of application in which it is used.

Vacuum technology has proven to be extremely effective in the handling of a wide variety of materials and parts and has thus opened up entirely new areas of application and solutions for handling technology.

## Handling tasks

The following keywords and symbols illustrate the significance of vacuum technology in handling technology as well as the various tasks that it is used to perform.

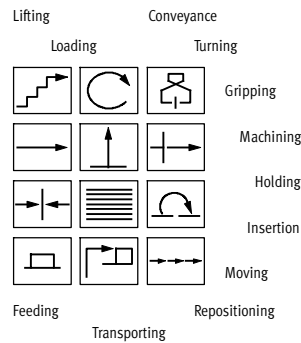

All of these tasks combined cover an almost unlimited range of applications in industry.

Industrial fields of application of vacuum technology include, for example:

- Special machine construction
- Packaging industry
- Food industry
- Woodworking industry
- Metalworking industry
- Automotive industry
- Electrical engineering industry

## General

Vacuum technology generally tends to come under the umbrella term of gripper technology.

In handling technology, a large number of applications use mechanical gripper technology to great effect.



Nevertheless, there are also a great many applications where this technology is being pushed to its limits.

This is where vacuum technology frequently comes into play and, indeed, is creating entirely new concepts and possibilities.



## Advantages

Vacuum in handling technology means:

- Gentle handling of fragile parts
- Simple component and system design
- Compact, space-saving design
- Low weight, i.e. suitable for extremely dynamic movement
- Fast cycle times possible
- Low-cost
- Low maintenance costs
- Can be adapted to suit many requirements

## Important factors to consider

The decision to use vacuum technology or another handling technology depends on a number of different factors. Some of the most important factors to consider are described here.

- Weight of the workpiece
- Temperature of the workpiece or its surface
- Speed per unit of time for cycle completion
- Shape of the workpiece surface
- Roughness of the workpiece surface
- Stroke travel and conveying distances for handling

Having such a wide range of vacuum component variants makes it easy to find the right components for just about any application, taking into account the above factors, with product features such as heat resistance, speed, suction capacity etc.

Festo provides a software tool which helps you select or find the right vacuum components for your specific applications.



# Basic principles of vacuum technology

Introduction

## Single-stage and multi-stage ejectors

### General

Nowadays, wherever vacuum technology is used, you will also find increased use of vacuum ejectors.

There are, of course, still a great many special applications in which the vacuum pump is as indispensable as ever. Nevertheless, many applications in handling technology favour the use of ejectors. The most convincing

arguments in favour of ejectors are their low initial costs, low maintenance costs and greater flexibility in terms of application compared with other vacuum generators.

As already explained in the section “Components for vacuum generation” → 2, there are two different design principles for vacuum ejectors. However, the venturi operating principle applies to both types.

### Function principle

As described earlier, all ejectors work according to the venturi operating principle.

All ejectors based on this principle have a jet nozzle (laval nozzle) and,

depending on the design principle, at least one receiver nozzle.

### Design principle

#### Single-stage ejector:

This ejector principle includes a jet nozzle (laval nozzle) and one receiver nozzle.

The extraction of ambient air and the generation of a vacuum therefore take place within a chamber and the gap between the jet nozzle and receiver nozzle.

The compressed air or drawn-in ambient air is generally discharged into the atmosphere (environment) via a silencer connected directly after the receiver nozzle.

#### Single-stage ejector:

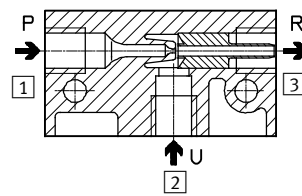

- 1 Supply port/jet nozzle
- 2 Vacuum/suction cup connection
- 3 Exhaust air/receiver nozzle

#### Multi-stage ejector

Like the single-stage ejector, this design principle also includes a jet nozzle (laval nozzle), in which the compressed air flowing in is accelerated to up to five times the speed of sound, followed by a receiver nozzle.

Behind the first receiver nozzle there are additional nozzle stages, each of which has a bigger nozzle diameter in proportion to the falling air pressure. The drawn-in air from the first chamber, combined with the compressed air from the jet nozzle, is thus used as a propulsion jet for the other chambers.

After exiting the last receiver nozzle, the exhaust air is generally discharged into the atmosphere (environment) via a silencer.

#### Multi-stage ejector

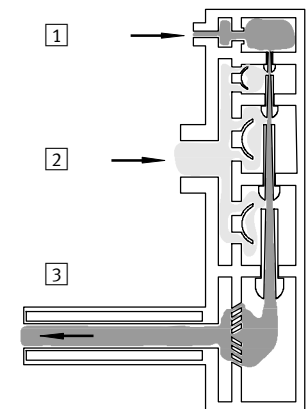

- 1 Supply port/jet nozzle
- 2 Vacuum/suction cup connection
- 3 Exhaust air/receiver nozzle

# Basic principles of vacuum technology

Introduction

## Single-stage and multi-stage ejectors

### Basic information

A direct comparison of the design principles of single-stage and multi-stage ejectors frequently gives rise to discussions regarding the advantages and disadvantages of both principles.

Manufacturers of vacuum ejectors tend to favour one of the two design principles, thus making it difficult to get an objective opinion.

Viewed objectively, handling technology using a vacuum comes down to a few important variables, with which the performance of a

vacuum generator can be measured or evaluated.

### Efficiency $\eta$ as a function of vacuum $\Delta p_u$

**Evacuation time = Time (s) required to generate a specific vacuum.**

**Air consumption = Air consumption (l/min) of the ejector required to generate a specific vacuum.**

These variables – evacuation time, air consumption and the volume dependent on the vacuum – produce a formula, which can be used to calculate the efficiency of a vacuum generator. This is the most objective criterion that can be used to assess the performance of different vacuum generator types.

$$\eta(\Delta p_u) = \frac{1}{1 + \frac{t(\Delta p_u) \times Q}{V \times 60s/min}}$$

$\eta(\Delta p_u)$  = Efficiency of the vacuum generator in relation to low pressure

$t(\Delta p_u)$  = Evacuation time [s]

$Q$  = Air consumption [l/min]

$V$  = Volume to be evacuated (standard volume) [l]

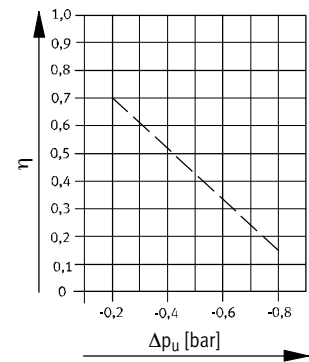

In practice, the job of a vacuum generator is to generate a specific vacuum in the shortest time possible, using as little air (energy) as possible.

### Misapprehension

**Suction flow rate = Suction air volume (l/min) that an ejector can draw in.**

In practice, the performance of an ejector is often – and incorrectly – measured on the basis of the suction flow rate. The misapprehension lies in the fact that the suction flow rate is often measured at atmospheric pres-

sure and the result is then used as the ejector rating. In fact, the suction flow rate falls progressively with an increasing vacuum, i.e. a high suction flow rate does not necessarily result in a short evacuation time.

Performance comparisons of vacuum ejectors based on the suction flow rate therefore have only a limited level of accuracy. Apart from this, the suction flow rates of the specimens are compared at the same vacuum level.

# Basic principles of vacuum technology

Introduction

## Single-stage and multi-stage ejectors

### Comparison

The aim of this comparison of single-stage and multi-stage ejectors is to evaluate variables or criteria that occur in practice and that can be used to measure the performance of the ejectors.

- Evacuation time
- Air consumption
- Efficiency

Variables such as noise level, air supply time or attainable vacuum also play an important role.

A comparison of single-stage and multi-stage ejectors in practice produces the following general observations, which should be borne in mind before proceeding any further.

General findings		
Variables/criteria	Single-stage	Multi-stage
Suction flow rate	Average	High At low vacuum level up to approx. 50%
Evacuation time	Very short <sup>1)</sup> In the higher vacuum range from 30 ... 50%	Very short <sup>1)</sup> In lower vacuum range up to 30 ... 50%
Initial costs	Low	Relatively high
Noise generation	Relatively high	Low

1) see diagram below

### Evacuation time

In general, the multi-stage ejector can, up to a pressure range of approx. 30 ... 50% vacuum, generate this pressure faster or evacuate the volume faster than the single-stage ejector.

However, a pressure of -0.4 ... -0.8 bar or a vacuum of between 40 and 80% is normally required in practice.

Looking at the chart illustrating this comparison, it is obvious that single-stage ejectors have a clear advantage over multi-stage ejectors in this case. The higher the vacuum level, the more time the multi-stage ejector takes to generate it.

Operating pressure p as a function of the evacuation time t

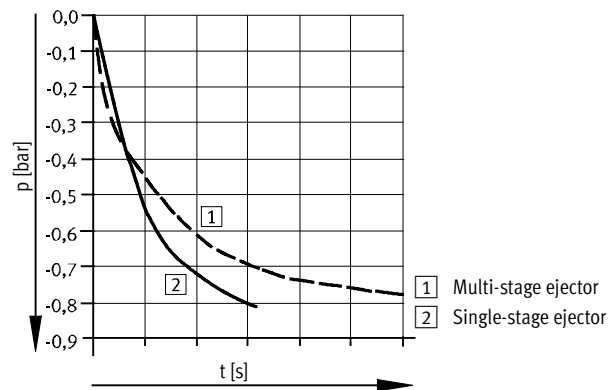

### Air consumption

Multi-stage ejectors have, on average, a much lower level of air consumption and thus consume less energy than single-stage ejectors, giving them a

clear advantage over single-stage ejectors. However, if we look at this information in context with the evacuation time,

the advantage is not so clear-cut. Although multi-stage ejectors have a lower level of air consumption, their evacuation time is higher. This

considerably reduces the energy-saving benefits.

### Suction flow rate

Single-stage ejectors have a lower suction flow rate than ejectors based on the multi-stage principle. Multi-stage ejectors in the low vacuum range of approx. 30 ... 50% can thus

draw in higher volumes over the same amount of time. However, as the vacuum level increases (from approx. 30 ... 50%),

this progressive curve falls off rapidly for multi-stage ejectors (see chart). In other words, as pressure increases, the initial gains of a higher suction

rate fall below the values achieved with single-stage ejectors.

# Basic principles of vacuum technology

Introduction

FESTO

## Single-stage and multi-stage ejectors

Noise level, vacuum level and air supply time

In comparison, single-stage ejectors have a relatively high level of noise generation. Because the compressed air is slowed down by the series of nozzle stages before it reaches the

atmosphere in “weakened” form in the case of multi-stage ejectors, the noise level is, accordingly, lower than with single-stage ejectors. The noise levels in single-stage ejectors are,

however, counteracted with suitable silencers.

Both design principles reach the same vacuum level, although single-stage ejectors do so in a shorter time.

There are very few differences in air supply time, although a single-stage ejector has a smaller volume to supply with air, which gives them a minimal time advantage.

## Summary

The cause of the somewhat poorer evacuation time of the multi-stage ejector lies in the fact that although the second and subsequent nozzle stages generate a high suction capacity, these are decoupled at a relatively low vacuum level. This means that when the pressure is higher, only the first nozzle stage draws in air. This first nozzle stage is

considerably less efficient than a single-stage ejector. It is important, however, to remember that these findings must be viewed as generalisations and should therefore be used for reference purposes only. Irrespective of the design principle, different results are obtained when the initial values, which interact with one

another, are changed.

Although increasing the laval nozzle diameter while maintaining a constant operating pressure increases the suction rate, it also extends the evacuation time and, in extreme cases, the desired vacuum cannot be reached without increasing the operating pressure.

This example illustrates how all of these variables are dependent on each other. If one variable changes, this affects the other variables as well.

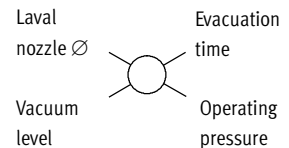

## Conclusion

The comparison shows just how difficult it is to reach an objective conclusion about the pros and cons of both operating principles.

And that's to say nothing of deciding on a preferred operating principle or a “test winner”. Basically, the benefits of both principles lie in very specific areas and they justify their right to

exist on this basis.

It is also easy to see how minor technical adjustments affect the ejectors and how both operating principles can be optimised to suit the relevant application (e.g. by varying the laval or receiver nozzle diameter). Both operating principles can thus achieve degrees of efficiency or

possess attributes that defy any generalisation. In conclusion, it can be said that the single-stage ejector achieves its best results in applications with average or higher pressure (vacuum). The simple design makes this operating principle more cost-effective and, in terms of dimensions,

more manageable than the multi-stage principle.

The multi-stage ejector, on the other hand, achieves its best results wherever a relatively low vacuum (up to approx. -0.3 bar) needs to be generated quickly and wherever energy costs play an important role.

# Basic principles of vacuum technology

Introduction

## Energy cost comparison between vacuum ejectors and vacuum pumps (electric)

Given that energy is a scarce, valuable and, above all, expensive resource, energy costs play an important role in choosing a suitable vacuum system. The air consumption of a vacuum system might not initially seem to be a particularly important consideration. However, the amount of energy that is necessary to operate a pneumatic vacuum ejector with compressed air

cannot be overlooked. You should therefore remember one golden rule at all times: air is expensive.

With electrically driven vacuum pumps, on the other hand, energy costs can be measured and assessed much more easily on the basis of current consumption.

The fact is that in order to generate

compressed air from atmospheric air, taking into account all costs such as material, depreciation, labour costs, etc., with electricity tariffs (industry) of € 0.10/kWh, you must reckon on costs of approx. € 0.02 per 1 m<sup>3</sup> volume at 7 bar (normal supply pressure). These costs apply in the low pressure range up to 10 bar. In the high pressure

range (10 ... 20 bar), the costs for compressed air increase by approx. 100%.

Before proceeding any further, it is important that we mention some of the criteria that should be considered when making a comparison of vacuum ejectors and vacuum pumps.

## Vacuum ejector

For

- Energy consumed only as required. Compressed air or energy is only consumed during the suction operation and during “workpiece handling” in an operation cycle. The vacuum generator remains switched off for the rest of the time (discharge, return). Ejectors have fast response times (start and stop times) and can therefore be switched off when no vacuum is required (→ circuit diagram 1).
- Vacuum ejectors require absolutely no servicing apart from the prefilter and have no moving parts.

Circuit diagram 1

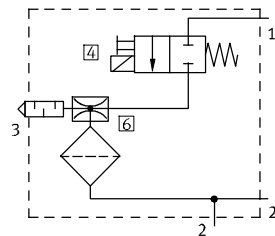

- 1 = Compressed air connection
- 2 = Suction cup connection
- 3 = Exhaust port
- 4 2/2-way valve
- 6 Non-return valve

- Energy-saving function: Many ejectors (compact ejectors) have this function. Compressed air is only consumed during generation of the vacuum. Once the vacuum level has been reached, the ejector is switched off. The vacuum is maintained and monitored using valves and switches (→ circuit diagram 2).  
Energy-saving function = 4 2/2-way valve + 5 Switch + 6 Non-return valve
- Their low weight/mass ratio and their small unit volume, not to mention the fact that they can be installed in any mounting position, are also worth noting.
- A relatively high vacuum of up to 85% can be attained.

Circuit diagram 2

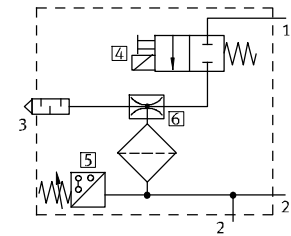

- 1 = Compressed air connection
- 2 = Suction cup connection
- 3 = Exhaust port
- 4 2/2-way valve
- 5 Switch
- 6 Non-return valve

Against

- With Festo ejectors, the suction rate is relatively limited at approx. 16 m<sup>3</sup>/hour.
- Higher compressed air consumption per m<sup>3</sup> vacuum increases energy costs dramatically. However, this is compensated by the air/energy-saving functions.

# Basic principles of vacuum technology

Introduction

## Vacuum pump

For

- With some designs a very high vacuum level (up to  $10^{-4}$  mbar = 99.99999%) can be attained.
- High suction rates of up to 1,200 m<sup>3</sup>/hr. possible.

Against

- Electro-mechanical vacuum pumps are almost always in continuous operation, the vacuum requirements are regulated by means of valves. This means that current consumption and, consequently, energy costs are very high.
- High initial costs and ongoing maintenance costs.
- Large weight/mass ratio and large unit volume as well as fixed mounting positions.

## Energy cost comparison/sample calculation

In this example, we are comparing a vacuum ejector (pneumatic), both with and without an air-saving function, with a vacuum pump (electrical) of similar performance. Using a calculation example, we want to create a cost or energy cost comparison over a period of one year.

- The electricity price is based on industry tariffs (€ 0.10/kWh).
- The costs for compressed air refer to, as mentioned earlier, a 1 m<sup>3</sup> volume with 7 bar pressure. All costs such as material, depreciation, labour costs, etc. are taken into account in the calculation (€ 0.02/m<sup>3</sup>).
- Additional assumed numerical values such as time specifications, for example, may apply depending on the application.

Electricity price [€/kWh]	Compressed air costs [€]	System capacity [kW]	Remarks
0.05	0.02	approx. 1,100	Large system
0.10	0.02	approx. 1,100	Large system
0.10	0.03	approx. 20	Small system

# Basic principles of vacuum technology

Introduction

## Calculation base

### Ejector operation cycle

- Ejector with air-saving function: Air consumed (energy consumption) only while the workpiece is being received (picked up) (= 0.5 s).
  - Ejector without air-saving function: Air consumed (energy consumption) for reception (pick-up) and transport of the workpiece (= 2 s).
  - Vacuum pump: Energy consumed for the entire operation cycle, as the pump is not normally switched off (= 5 s).
- The figure on the right shows an operation cycle for a vacuum system. The individual work steps of the system are subdivided into time sectors. The amount of time allocated to the work steps depends on the vacuum generator.

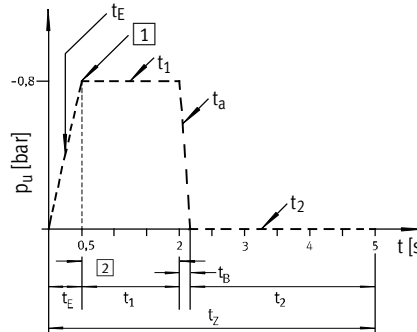

- $t_E$  = Evacuation time
- $t_1$  = Transport
- $t_a$  = Discharge
- $t_2$  = Return
- 1 = Pick-up
- 2 = Time saved

Variables/criteria		Assumed numerical values
Initial costs for vacuum pump	[€]	715
Initial costs for ejector	[€]	337
Maintenance costs/year for vacuum pump	[€]	306
No. of operating days/year		250
No. of operating hours/day		16
Time per operation cycle	[s]	5.0
Time for pump ON	[s]	5.0
Time for ejector ON <sup>1)</sup>	[s]	2.0
Time for ejector ON <sup>2)</sup>	[s]	0.5
Price per kWh (industry tariff)	[€]	0.10
Price per m <sup>3</sup> for compressed air at 7 bar	[€]	0.02
Supply pressure for ejector	[bar]	6
Energy used to generate compressed air (1m <sup>3</sup> at p = 7 bar)	[kWh/m <sup>3</sup> ]	0.095

- 1) Without air-saving function
- 2) With air-saving function

## General calculations

When comparing the energy costs for both vacuum generators, the following calculations must first be performed:

- Number of products per year (hours)  
Formula:  
Total running time (s)/Time per operation cycle (s)  
=  $250 \times 16 \times 3,600 / 5$   
= 2,880,000 hours
- Proportion of pump operation to operation cycle (%)  
Formula:  
Time for pump ON (s)/Time per operation cycle (s) x 100  
=  $5 / 5 \times 100$   
= 100%
- Proportion of ejector operation without air-saving function to operation cycle (%)  
Formula:  
Time for ejector ON<sup>1)</sup> (s)/Time per operation cycle (s) x 100  
=  $2 / 5 \times 100$   
= 40%
- Proportion of ejector operation with air-saving function to operation cycle (%)  
Formula:  
Time for ejector ON<sup>2)</sup> (s)/Time per operation cycle (s) x 100  
=  $0.5 / 5 \times 100$   
= 4%

- 1) Without air-saving function
- 2) With air-saving function

# Basic principles of vacuum technology

Introduction

## Vacuum ejector calculation

The calculations for the vacuum ejector with and without the air-saving function give us the following partial results:

(air consumption at P = 6 bar:  
505 l/min)

- Running time per year  
Formula:  
No. of products (units) x Time for ejector per unit (s)  
2,880,000 unit x 2 s  
1) = 5,760,000 s (96,000 min)  
2) = 1,440,000 s (24,000 min)
- Air consumption per year  
Formula:  
Running time per year (min)/  
Air consumption (l/min)  
96,000 min/505 l/min  
1) = 48,480 m<sup>3</sup>  
2) = 12,120 m<sup>3</sup>
- Energy costs per year  
Formula:  
Air consumption (m<sup>3</sup>)  
x Price per m<sup>3</sup> for compressed air (€)  
48,480 (12,120) m<sup>3</sup> x € 0.02  
1) = € 969.60  
2) = € 242.40

Variables/criteria		Assumed numerical values
Air consumption at P = 6 bar	[l/min]	505
Total air consumption per year at P = 6 bar <sup>1)</sup>	[m <sup>3</sup> ]	48,480
Total air consumption per year at P = 6 bar <sup>2)</sup>	[m <sup>3</sup> ]	12,120
Air saving per year <sup>2)</sup>	[m <sup>3</sup> ]	36,360
Air saving per year <sup>2)</sup>	[%]	75
Energy costs per year <sup>1)</sup>	[€]	969.60
Energy costs per year <sup>2)</sup>	[€]	242.40
Energy saving per year <sup>2)</sup>	[€]	727.20

1) Without air-saving function  
2) With air-saving function

## Electric vacuum pumps calculation

The calculations for the vacuum pump give us the following partial results:

- Running time per year  
Formula:  
Operating hours per day  
x Operating days per year  
16 hours x 250  
= 4,000 hours
- Energy consumption per year  
Formula:  
Running time per year x Energy consumption per hour  
4,000 hours x 0.55 kW  
= 2,200 kWh
- Energy costs per year  
Formula:  
Energy consumption per year  
x Costs per kWh  
2,200 kWh x € 0.10  
= € 220

Variables/criteria		Assumed numerical values
Energy consumption/operating hour	[kWh]	0.55
Energy consumption/year	[kWh]	2,200
Energy costs/year	[€]	220



# Basic principles of vacuum technology

Introduction

## Cost comparison of the vacuum ejector and vacuum pump

The costs of the vacuum system are made up of three cost types:

- Investment costs
- Maintenance costs
- Energy costs

Investment costs are one-off costs, while maintenance and energy costs are incurred annually.

## Result

A direct cost comparison shows that the vacuum pump has the lowest energy costs, closely followed by the ejector with the air-saving function.

The ejector without the air-saving function has considerably higher energy costs than the other vacuum systems. If we also take maintenance

and investment costs into account, this reduces the advantage that the vacuum pump has over the other systems due to its low energy costs.

Cost type		Vacuum pump	Ejector without air-saving function	Ejector with air-saving function
Investment	[€]	715	337	337
Maintenance <sup>1)</sup>	[€]	306	–	–
Energy <sup>1)</sup>	[€]	220	969.60	242.40

1) annual costs for a vacuum pump after approx. 4,000 to 6,000 hours

## Conclusion

The calculation example shows that ejectors more than justify their existence.

The high investment costs for vacuum pumps as well as the annual

maintenance costs associated with their continuous use and wearing parts confirm this conclusion.

While ejectors may use more energy,

their simple design keeps initial costs and maintenance costs to a minimum. There are, of course, a great many areas of application that are

dominated by the vacuum pump and where ejectors are not used. This is not the case, however, with handling technology.

# Basic principles of vacuum technology

Introduction

## Leakage in vacuum systems

Ideally, when using vacuum applications in handling technology, the workpiece surfaces on which the suction cups have to rest should be smooth and impervious. A suction cup fits tightly against this type of surface.

When a vacuum is generated, the sealing rim of the suction cup can fully seal the system against external atmospheric air. We therefore describe this as a leak-proof system. The holding force of the suction gripper on the workpiece increases as the vacuum level in the system increases compared with the external atmospheric pressure.

Unfortunately, these ideal surface conditions do not always exist on the workpieces to be moved. The materials are often air-permeable (e.g. sheets of paper) or very rough and uneven.

In these applications, the vacuum suction grippers cannot completely seal the system against atmospheric air. If atmospheric air constantly enters the system during vacuum generation, we describe this as a leaking system.

## Leak-proof systems

In vacuum technology, the performance of the vacuum generator for the handling of leak-proof material depends, among other things, on how quickly the system can generate a specific vacuum. This rating is known as the evacuation time of the vacuum generator.

When a specific volume is being evacuated, the course of the time/pressure curve travels upward proportionally, i.e. the higher the vacuum level, the stronger the fall in the suction capacity of a vacuum generator and the longer it takes to attain an even higher vacuum level.

Evacuation time  $t_E$  as a function of vacuum  $p_u$

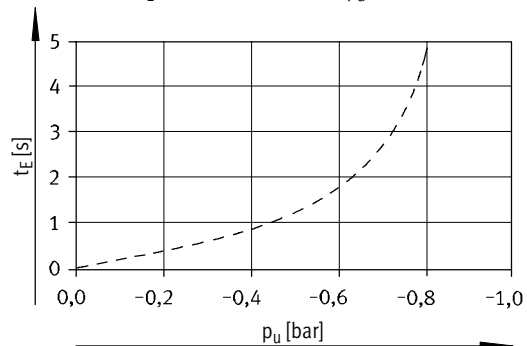

## Leaking systems

The requirements for handling porous materials (leaking systems) are different. In order to attain or maintain the desired vacuum level, the vacuum generator must be capable of

continuously evacuating the air (leakage air) entering the system. The maximum attainable vacuum that a vacuum generator can produce is normally measured under ideal

conditions (leak-proof system). However, in this case the leakage air entering the system prevents the vacuum generator from reaching or being able to attain its maximum

performance level. To determine the leakage air volume, it is recommended that you carry out a test (→ 27, "Selecting vacuum generators according to leakage flow").

## Remedy

In general, there are two options for optimising or increasing the vacuum level in leaking systems.

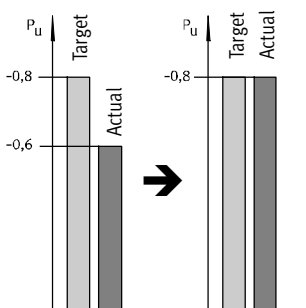

Option 1: Using a high-performance vacuum generator.

- Advantage:
- Power transmitted as required
  - Simple solution
- Disadvantage:
- Leakage remains high
  - High energy costs

Option 2: Reducing the suction cup diameter or orifices.

- Advantage:
- Leakage is reduced (energy costs)
- Disadvantage:
- Power transmission may be below the required vacuum level.

To select the correct vacuum generators for handling leakage flow, you need to perform a test setup as outlined above. With the aid of charts, you can then select the right vacuum generator. This selection aid is described in detail on page 27.

# Basic principles of vacuum technology

Introduction

## Selecting vacuum generators according to leakage flow

A reliable method is needed to determine the exact leak rate in vacuum systems or applications. Only then can optimal remedial action,

e.g. the selection of vacuum generators with larger dimensions, be taken and the functional reliability of the vacuum system guaranteed.

## Graphical representation as a tool

- Graphical representation of the suction capacity in relation to vacuum/operating pressure in a chart (all ejectors in a single chart).

Suction capacity  $q_n$  as a function of vacuum  $p_u$

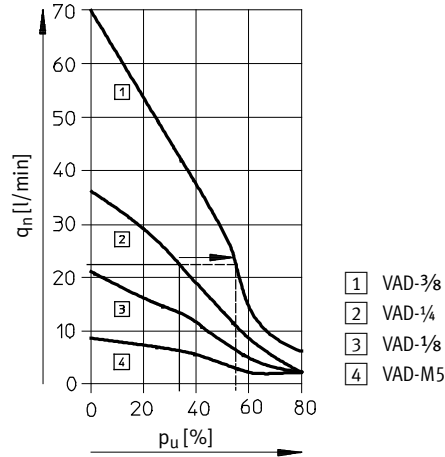

All curves in the chart have an almost linear downward course. The maximum suction capacity of the individual vacuum ejectors is reached at atmospheric air pressure (0% vacuum). The higher the vacuum level, the lower the suction capacity of a vacuum generator, up to a maximum limit. This chart is very useful for finding out quickly and reliably whether a vacuum generator is needed to achieve the desired vacuum level with leaking materials.

## Test setup

- Perform a test setup with an ejector as the vacuum generator, a vacuum gauge (pressure gauge) as the measuring instrument as well as a suction gripper and workpiece as the leakage source. The test setup is illustrated in the following figure.

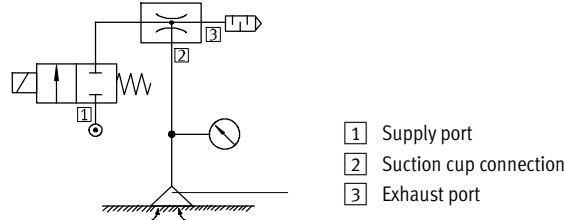

The operating pressure (vacuum) of the system is now measured at a constant supply pressure. The performance of an ejector under normal operating conditions, i.e. without leakage, can be determined from its technical data as well as from the 'Suction capacity as a function of vacuum/operating pressure' chart. The measurement results from the test setup are then compared with the known data.

## Selecting vacuum generators according to leakage flow

### Procedure

Where systems are clearly leaking (e.g. because of porous or rough workpieces), the leak rate must be determined.

The following procedure is recommended for finding a suitable vacuum generator that is compatible

with the relevant application and can generate the required vacuum level:

### Determining the leak rate



- Perform the test setup
- Read the vacuum or operating pressure achieved
- Compare the result with the course of the curve in the chart
- Suction capacity difference = leak rate

In a test setup like the one illustrated earlier, a workpiece is picked up using a defined suction gripper size, a vacuum generator and pressure supply (5.5 ... 6 bar).

In a leak-proof system, the value indicated on the vacuum gauge must correspond to the value contained in the technical data for the vacuum generator.  
In a leaking system, the vacuum attained is read from the vacuum gauge.

The leak rate can then be determined on the basis of the measured vacuum value in conjunction with the chart (Suction capacity as a function of vacuum/operating pressure).

### Example

In a test setup using the ejector , a vacuum level of 35% is achieved at full pressure supply. Starting from this result, if we draw a horizontal line and a vertical line intersecting the ejector curve , the

residual airflow can be read from the suction capacity scale. This residual airflow corresponds to the leak rate of the system, as in the case of a leak-proof system the residual airflow would be = 0.

Result:  
The residual airflow or leak rate is = 22 l/min.  
The only disadvantage of this method lies in the fact that it is impossible to tell whether the leakage is caused by the workpiece itself or by a rough surface underneath the edge of the suction gripper.

### Determining the correct ejector size

- Compare the intersection of the leak rate (now known) with the curves of other ejectors.
- Determine the attainable vacuum by projecting the intersections with the leak rate downwards.
- Select the ejector that reaches the required vacuum level.

Conversely, with a known leak rate of 22 l/min, we can now read the vacuum level attainable with other vacuum generators from the "Suction capacity as a function of vacuum" chart.

If we now extend the horizontal line that we drew previously in the chart to determine the leak rate (Procedure 1), we can determine the vacuum level attained with other vacuum

generators (at the same leak rate) from the intersection with the curves of other ejectors and the subsequent downwards projection to the vacuum scale.

# Basic principles of vacuum technology

Introduction

FESTO

## Selecting vacuum generators according to leakage flow

### Example

If we extend this horizontal line, it must intersect another curve. In the case of the next largest vacuum generator **1** VAD-3/8, the line intersects at 52% vacuum. The curve for the next smallest vacuum generator **3** is overshoot and there is no intersection. In other words, the low performance value would mean that no vacuum is generated with this leakage flow, as the quantity of air drawn in is lower than the quantity of air that is discharged because of the leakage.

Suction capacity  $q_n$  as a function of vacuum  $p_u$

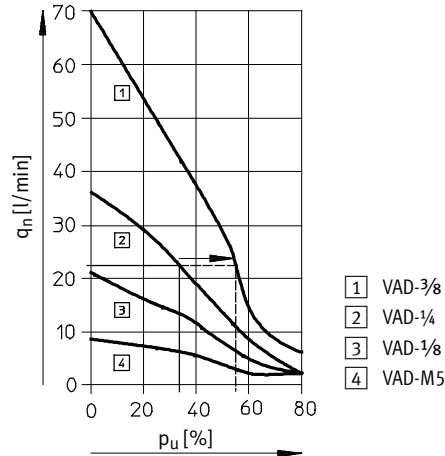

Result:

In this application, the next largest vacuum generator **1** would attain a vacuum level of 52%. If this vacuum level were sufficiently high for the application, this would be the right choice of ejector. Otherwise, a higher-performance ejector should be chosen (curves not available in this chart).

### Conclusion

This method is useful for determining the correct ejector size where the leak rate is known.

However, it should be noted that leakage can occur at other positions, e.g.:

- seals,
  - tubing connectors,
  - couplings
- in a vacuum system.





Leakage, for whatever reason, should be avoided if at all possible.

- Safety risk  
A leakage flow increases the risk of the vacuum system no longer being able to attain the required pressure and the workpiece being dropped during handling.

- Energy costs  
Where there is a leakage flow, the air consumption (energy consumption) of an ejector is much higher than that of a leak-proof system.
- Time  
A leakage flow means it takes longer to reach the required vacuum level.

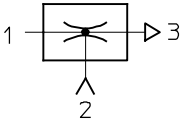
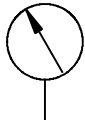
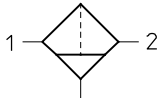
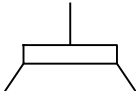
# Basic principles of vacuum technology

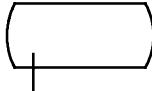
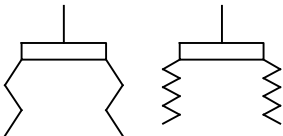
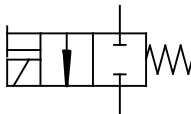
Introduction

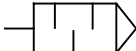
Technical symbols			
<p>This system description uses technical symbols to represent individual components in function charts as well as in component descriptions. These symbols are illustrated and described in this section.</p>	<p><b>Vacuum ejector</b></p> <p>The technical symbol used in the function charts for all Festo vacuum generators.</p> 	<p><b>Vacuum gauge</b></p> <p>Measuring and checking device for the analogue vacuum display.</p> 	<p><b>Filter</b></p> <p>Filters the drawn-in air and prevents contamination of the ejector.</p> 
	<p><b>Vacuum suction cups</b></p> <p>Standard, extra-deep, round, oval. In technical circuit diagrams, this symbol represents the complete suction gripper (suction cup holder + suction cup + accessories).</p> 	<p><b>Non-return valve</b></p> <p>Prevents the drawn-in air from flowing back against the intake direction, i.e. the valve permits flow in one direction only.</p> 	<p><b>Reservoir container</b></p> <p>Air reservoir to support the setting down of a workpiece that was previously picked up.</p> 
<p><b>Bellows suction gripper</b></p> <p>1.5 convolutions, 3.5 convolutions. In technical circuit diagrams, this symbol represents the complete suction gripper.</p> 	<p><b>Solenoid valve</b></p> <p>Different valve types (mostly 2-way valves) perform the ON/OFF or exhaust function in vacuum technology.</p> 	<p><b>Throttle</b></p> <p>For controlling the flow rate or pressure.</p> 	
<p><b>Silencers</b></p> <p>Dampens the compressed air, which flows from the venturi nozzle at ultrasonic speed, before it is discharged into the atmosphere.</p> 			

# Basic principles of vacuum technology

Introduction

## Circuit diagrams with vacuum components

Circuit diagrams help provide a general understanding of the mode of operation of vacuum components as well as a schematic representation of their function within the overall

system. The technical drawings below contain examples of pneumatic circuit diagrams. These are intended as a reference to help you understand the symbols used in vacuum technology.

### Basic vacuum circuit

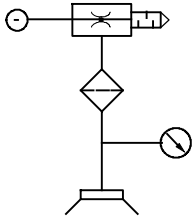

### Regulated vacuum circuit

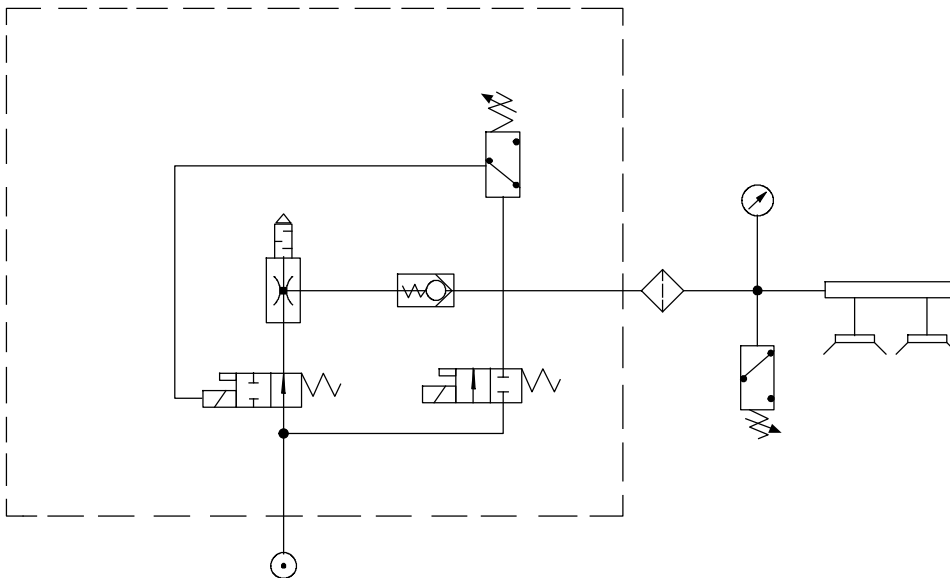

# Basic principles of vacuum technology

Introduction

## Vacuum ejectors

Vacuum generators are the central element of any vacuum system. The mode of operation of vacuum ejectors and the venturi principle were already explained in the Basic principles section (➔ 12).

Festo only uses ejectors that operate according to the single-stage design principle.

Festo offers a wide selection of ejectors of different types and with different equipment to suit a whole host of application and performance requirements. These vacuum generators are subdivided into the following ejector groups:

- Basic ejectors
- Inline ejectors
- Compact ejectors

Each group is, in turn, subdivided into a wide range of performance classes and equipment types.

## Standard and inline ejectors

The functions of standard and inline ejectors are essentially limited to the basic function of an ejector, i.e. generation of a vacuum.

The ejector design basically consists of just a single jet nozzle that operates according to the venturi principle.

Control, monitoring and other functions depend on external and additional components within the vacuum system. These ejectors are therefore much smaller compared with other vacuum ejectors.

Because they are so compact, ejectors of this type can generally be used directly wherever a vacuum is required, even in large quantities. They are also used in vacuum processes that do not require complex and sophisticated control technology.

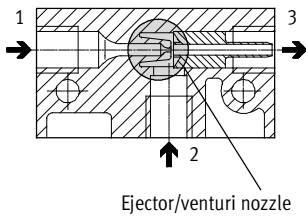

- 1 = Compressed air / nozzle
- 2 = Vacuum / suction port
- 3 = Exhaust air/receiver nozzle

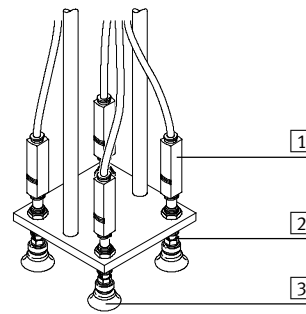

- 1 Ejector
- 2 Suction cup holder
- 3 Suction cup



# Basic principles of vacuum technology

Introduction

FESTO

## Compact ejectors

In practice, demands on vacuum systems in terms of function, speed (performance) and, increasingly, economy tend to be extensive.

Vacuum ejectors are therefore capable of much more than just vacuum generation. Compact ejectors have a number of components integrated in or on the housing, which makes them complete function units.

Depending on the ejector and design, these function units contain the following components in addition to the vacuum generator:

- Solenoid valves
- Filter
- Non-return valves
- Silencers
- Vacuum switch

## Vacuum ejector VADMI-...



Taking a vacuum ejector VADMI-... as an example, we can see the components and functions of a complete function unit.

The individual components are identified in the sectional drawing (→ 34). The functions, benefits and special features are described in the notes.

# Basic principles of vacuum technology

Introduction

## General information

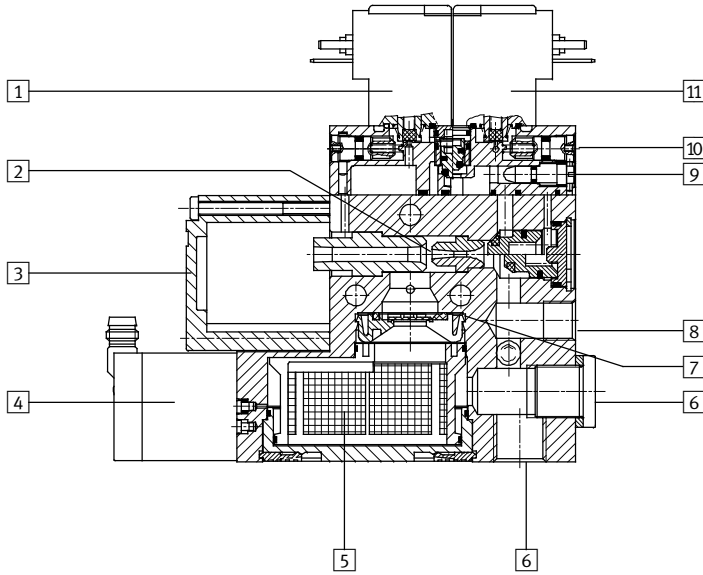

## Components

- |  |                                  |                                |   |
|--|----------------------------------|--------------------------------|---|
| 1 Solenoid valve for ejector pulse (VADMI-..., VAD-M...-I-...) | 3 Special silencer               | 7 Non-return valve             | 10 Manual override                      |
| 2 Venturi nozzle (jet and receiver nozzle)                     | 4 Vacuum switch                  | 8 Supply port                  | 11 Solenoid valve for vacuum generation |
|  | 5 Filter for air to be evacuated | 9 Manual ejector pulse control |   |
|  | 6 Two vacuum ports               |                                |   |

Description	Function		Benefits
1 Solenoid valve for ejector pulse – 3/2-way valve – Controls ejector pulse	If the voltage is switched off at the solenoid valve for vacuum generation 11 and switched on at the solenoid	valve for ejector pulse, the vacuum is rapidly purged at port 6 as a result of the application of pressure.	<ul style="list-style-type: none"> <li>• Rapid purging of vacuum</li> <li>• Fast and precise setting down of workpieces</li> <li>• Short vacuum ejector operation cycles</li> </ul>
2 Venturi nozzle (jet and receiver nozzle) – Most important ejector component – Used for vacuum generation	When pressure is supplied to the supply port 8, compressed air flows into the jet nozzle. The narrowing of the nozzle accelerates the compressed air to up to 5 times the speed of sound. This air flow is collected by the	receiver nozzle and directed into the silencer 3. A suction effect, which evacuates the air from the filter 5, is created between the jet nozzle and the receiver nozzle. A vacuum is created at the vacuum port 6.	<ul style="list-style-type: none"> <li>• Ejector performance can be modified and controlled by varying the nozzle diameter or supply pressure</li> </ul>
3 Special silencer (closed, surface or round type) – For noise reduction in exhaust air	The silencer is made from air-permeable plastic or a metal alloy. The air flow exits the jet nozzle at up to 5 times the speed of sound. The	silencer dampens this air flow, thus reducing the noise level before the compressed air (exhaust air) enters the atmosphere.	<ul style="list-style-type: none"> <li>• Minimises the noise level from the exhaust air during ejector operation</li> </ul>

# Basic principles of vacuum technology

Introduction

FESTO

Components			
Description	Function		Benefits
<p>4 Vacuum switch with PNP or NPN output</p> <ul style="list-style-type: none"> <li>– For pressure monitoring</li> </ul>	<p>On the vacuum switch, the vacuum range for holding the workpiece is set using two potentiometers. Once the vacuum level is reached, a signal switches off the vacuum generator (air-saving function). The non-return valve 7 maintains the vacuum in this</p>	<p>status. If the vacuum range falls below the required level, the signal controls the switching on of the vacuum generator. If the required vacuum can no longer be generated because of a malfunction, the vacuum generator is switched off.</p>	<ul style="list-style-type: none"> <li>• Air-saving function: The vacuum generator is switched off within the required vacuum range</li> <li>• Safety function: Control of vacuum generator if vacuum level goes above or below the required values</li> </ul>
<p>5 Filter for air to be evacuated</p> <ul style="list-style-type: none"> <li>– With contamination indication</li> <li>– 40 µm grade of filtration</li> </ul>	<p>A large plastic filter is integrated between the vacuum port 6 and the vacuum generator 2 or non-return valve 7. During the suction</p>	<p>operation, the air is filtered before it enters the vacuum generator. A removable display window shows the degree of filter contamination.</p>	<ul style="list-style-type: none"> <li>• No contamination of the system</li> <li>• Protection of components</li> <li>• Display ensures maintenance is carried out regularly</li> </ul>
<p>6 Two vacuum ports (V) or (2)</p> <ul style="list-style-type: none"> <li>– With female thread</li> </ul>	<p>Vacuum components can be connected here (e.g. vacuum suction gripper).</p>	<p>Depending on the application, you can use either one output or both outputs simultaneously.</p>	
<p>7 Built-in non-return valve</p> 	<p>After the vacuum generator is switched off, this non-return valve prevents a backflow of the drawn-in</p>	<p>air, thus preventing a drop in pressure.</p>	<ul style="list-style-type: none"> <li>• The vacuum is maintained after the vacuum generator is switched off (air-saving function in connection with the vacuum switch 4).</li> </ul>
<p>8 Supply port (P) or (1)</p>	<p>The compressed air supply port (P) or (1) for generating the vacuum is contained in the ejector housing.</p>		
<p>9 Manual ejector pulse control</p>	<p>The intensity of the air flow and, consequently, the time taken to remove the workpiece from the</p>	<p>suction gripper, can be adjusted manually.</p>	<ul style="list-style-type: none"> <li>• The system can be optimised for the vacuum application</li> </ul>
<p>10 Manual override</p>	<p>Stem on the solenoid valve that can be switched without an electrical signal. However, an electrical signal</p>	<p>that is already present cannot be disabled.</p>	<ul style="list-style-type: none"> <li>• Manual switching of the solenoid valve</li> </ul>
<p>11 Solenoid valve for vacuum generation</p> <ul style="list-style-type: none"> <li>– 3/2-way valve</li> <li>– Controls vacuum generation</li> </ul>	<p>When the signal is activated, compressed air flows through the vacuum generator and creates a</p>	<p>vacuum. The air flow is interrupted when the signal is turned off.</p>	<ul style="list-style-type: none"> <li>• Air-saving function in connection with the vacuum switch 4 and the non-return valve 7</li> </ul>

# Basic principles of vacuum technology

Introduction

## Important variables

### Selecting a suction gripper

The main criteria to consider when selecting a suction gripper:

- Total volume of the vacuum system
- Cycle time of an operation
- Ejector economy
- Additional functions

### Total volume

The sum of the volumes is needed to calculate the cycle time of an operation.

The volume to be exhausted from the system is made up of the following:

- Suction cup volume
- Suction cup holder volume
- Tube volume

### Cycle time of an operation

When defining quantities, the time factor plays a decisive role. The evacuation time is used to determine how economical an ejector is.

Individual criteria for determining the duration of an operation cycle:

- Evacuation time: Time taken for the ejector to generate the required vacuum
- Air supply time: Time taken to set down the workpiece under suction (purging of the vacuum)
- Handling/return time

Evacuation time  $t_E$  for 1 l volume at 6 bar operating pressure  $p_u$

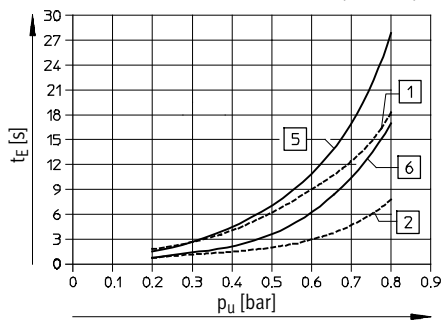

- 1 VN-05-H-...
- 2 VN-07-H-...
- 5 VN-05-M-...
- 6 VN-07-M-...

### Ejector economy

Factors for determining the energy consumption of an ejector:

- Air consumption per unit of time (specified in the ejector technical data)
- Number of operation cycles per unit of time

Air consumption  $q_n$  as a function of operating pressure  $p_1$

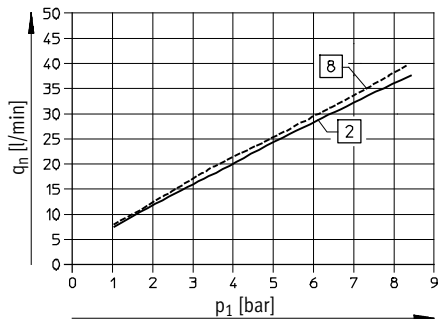

- 2 VN-07-H-...  
VN-07-M-...
- 8 VN-07-L-...

### Comparison of vacuum generators

Efficiency is a criterion which facilitates an objective comparison of various vacuum generator types.

The product section of this catalogue contains information to help you determine the efficiency of an ejector (→ 18).

The chart allows you to compare the efficiency curves of other vacuum generators.

Efficiency  $\eta$  as a function of vacuum  $\Delta p_u$  at  $P_{nom}$  6 bar

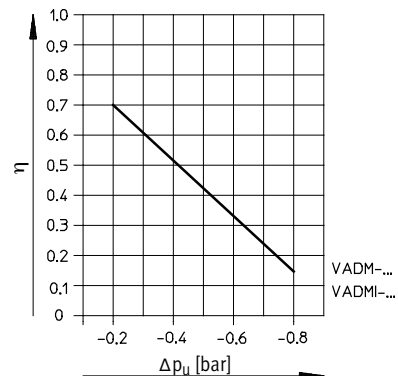

# Basic principles of vacuum technology

Introduction

## Suction grippers

### General data

Vacuum suction grippers provide the “link“ between the vacuum generator and the workpiece being transported.

They are a simple, low-cost and reliable solution for handling workpieces, parts, packaging, etc.

Festo offers a wide range of suction gripper designs:

- Universal suction gripper
- Flat suction gripper
- Bellows suction gripper
- Special suction gripper

### Mode of operation

When the suction gripper comes into contact with the workpiece surface, the same air pressure (atmospheric pressure) prevails on the top side and underside of the suction cup. The activated vacuum generator now

draws in the air on the underside of the suction cup. A vacuum is created. Given that air pressure within the vacuum is lower than that on the outside of the suction cup,

atmospheric pressure holds the workpiece on the suction cup.

The larger the vacuum, the greater the holding force pressing the suction cup onto the workpiece.

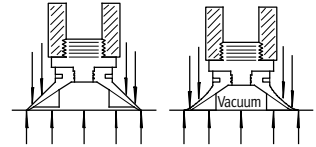

### Materials

The suction cups are available in different materials.

- Nitrile rubber
- Polyurethane
- Polyurethane, heat-resistant
- Silicone
- Fluoro rubber
- Butadiene rubber, anti-static

Depending on the range of application, the following conditions play an important role when deciding on the quality of the materials to be used:

- Resistance to wear
- Intensity of stress
- Industry in which gripper is to be used (food industry, electronics)
- Workpiece quality (surface, weight, sensitivity, etc.)
- Environment (chemically aggressive media, temperatures)

The criteria for selecting the right suction cup material are summarised in a table (→ 44).

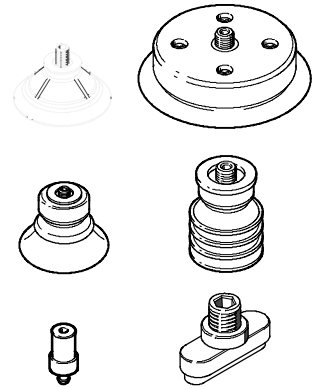

### Shapes

Suction grippers can move a wide variety of workpieces.

The range of workpiece surface structures and contours available demands versatile gripper technology. Vacuum technology allows a wide

variety of products and materials (shapeless, compact or porous) with a wide variety of surfaces (even, uneven, round, sloping or undulating) to be handled easily, cost-effectively and, above all, reliably.

Furthermore, it is possible to pick up workpieces with masses ranging from a few grammes right up to several kilograms.

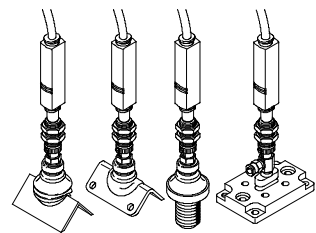

### Accessories

For every suction cup there is a suction cup holder to fit.

Depending on their design, these can be used for a variety of applications.

The suction cup holders are characterised based on the following criteria:

- Holder size
- Suction cup connection
- With or without height compensator
- Position and type of vacuum port
- Mounting thread

Suction cup holders are more than just mounting devices for suction cups.



# Basic principles of vacuum technology

Introduction

## Suction grippers

### Advantages of a bellows suction cup

When the volume of a bellows suction cup is evacuated, the suction cup shape contracts slightly. The workpiece is lifted gently in the process.

In practice, this so-called flexible vertical stroke can be used as a short vertical stroke to lift workpieces gently from their supports.

The evacuation of a bellows suction cup is divided into 2 phases:

**Phase 1**  
The suction cup is positioned on top of the workpiece without the influence of any external forces.

**Phase 2**  
A vacuum is created within the suction cup. The workpiece is drawn in and a state of equilibrium is achieved depending upon the size of the vacuum and the weight of the workpiece.

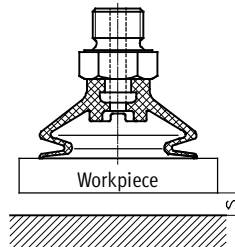
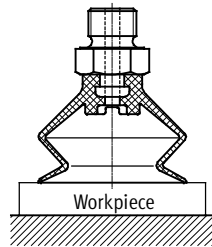

## Suction gripper selection guidelines

When designing a suction gripper for a specific handling task, there are several criteria to be taken into consideration:

Parameter	Effects on			
	Required suction force	No. of suction cups	Suction cup shape	Suction cup material
Workpiece dimensions	■	■	-	
Workpiece weight	■	■	■	
Workpiece rigidity	-	■	■	
Surface texture of the workpiece	Harsh	■	■	■
	Dry, wet	■	■	-
	Round, diagonal, curved	-	-	■
Environmental influences such as weather, cleaning agents, approval for use in the food industry, temperature	-	-	-	■
Distribution of suction grippers on the workpiece	■	■	-	
Arrangement of suction gripper in relation to direction of movement	■	■	■	
Max. acceleration	■	■	■	

# Basic principles of vacuum technology

Introduction

## Physical variables

The physical variables described below are components of the formulae that are needed to calculate the main criteria.

## Coefficient of friction $\mu$

The coefficient of friction is the friction factor between the suction gripper and workpiece. It defines the tangential forces.

In practice, it is very difficult to obtain precise specifications for this value. Suitable experiments should therefore be carried out for the relevant application.

In order to be able to select a design, the following theoretical guide values apply:

Surfaces	$\mu$
Oily	$\mu = 0.1$
Wet	$\mu = 0.2 \dots 0.3$
Rough	$\mu = 0.6$
Wood, metal, glass, stone ...	$\mu = 0.5$

## Safety value S

The regulations for the prevention of accidents (UVV) stipulate a safety factor of 1.5. This minimum value must be incorporated in the calculations.

In the case of critical, non-uniform or porous materials or rough surfaces, the factor should be increased to  $\geq 2$ . The safety value is also important for the position of the suction gripper.

A higher factor should also be selected in the case of a vertical suction gripper position or swivel motions.

With a horizontal suction gripper position, where the applied load acts vertically on the suction cup, a value of between 1.5 and 2 may be used.

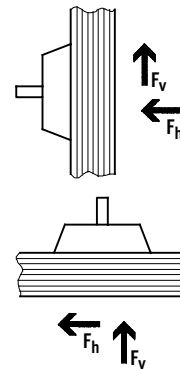

## Theoretical holding force $T_H$

This force is calculated with a dry surface for the various load conditions of the application.

The following factors are taken into account in this formula:

- Mass of the workpiece  $m$
- Coefficient of friction  $\mu$
- Acceleration of the system ( $m/s^2$ )
- Acceleration due to gravity ( $9.81 m/s^2$ )
- Safety value S

Only the result from the most unfavourable application load condition is taken into consideration.

## Breakaway force $F_A$

The breakaway force depends on the suction cup diameter and suction cup shape.

If several suction grippers are used simultaneously in a vacuum

application, the result of the theoretical holding force  $T_H$  calculation must be divided by the number of suction grippers.

This allows you to determine the holding force of each suction gripper. The breakaway force of the selected suction cup must always be greater than the determined holding force  $T_H$ .

When selecting a suction gripper, you can refer to the suction cup technical data to find out its breakaway force.

# Basic principles of vacuum technology

Introduction

## General procedure based on a calculation example

### Purpose & benefits

For safety and financial reasons, it is important that you design all processes and methods in accordance with their intended application. This is the only way of ensuring optimal deployment and utilisation of your system. (This also applies to vacuum technology.) It is therefore vital that

you create an optimal system design for the application in advance, so that the system can be sized and selected in accordance with requirements. To simplify this task, this section provides a step-by-step description of the basic procedure and theory

involved in selecting a vacuum system. A calculation example is provided to illustrate how the theory is applied in practice. You can follow the step-by-step system design process with the aid of this example.

The figure below illustrates step-by-step the recommended in-house procedure at Festo, which is used for the design or selection of a vacuum system.

### Problem definition

The problem definition produces specifications as well as system requirements.

- Material/surface
- Dimensions
- Directions of movement
- Cycle time/time allowed
- Design specifications

### Suction cup selection

To design a suitable suction cup you need to calculate the masses, holding forces and breakaway forces (→ 43). Workpiece surface finishes and suction cup material requirements must also be taken into account (→ 43).

### Assembly/mounting attachments

The following criteria should be considered when selecting mounting attachments:

- Workpiece surface
- Position of the vacuum port
- Type of vacuum port
- Type of mounting

A table listing the available holders is provided to help you select the right holder.

### Vacuum generator

When selecting a vacuum generator, the following values must be calculated:

- Total volume
- Cycle time
- Energy costs

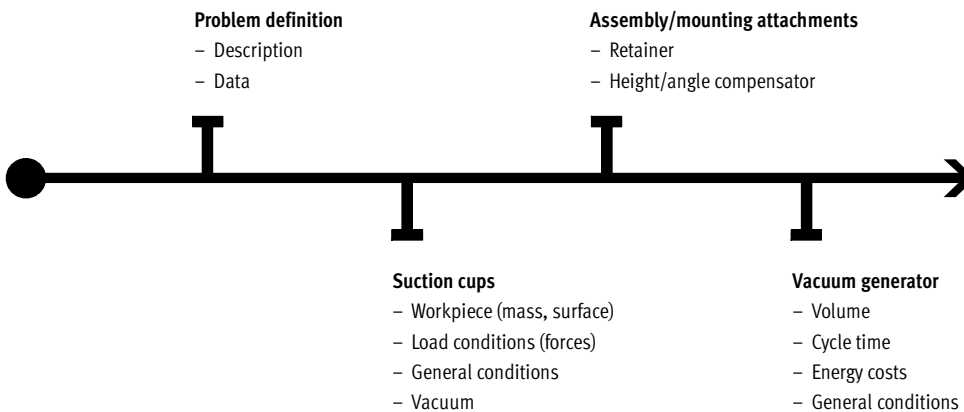



# Basic principles of vacuum technology

Introduction

## Software tool

As a special service Festo offers you free software. The software tool in question is a reliable, convenient and,

above all, quick way of designing your vacuum systems. It allows you to specify the vacuum components of

your system individually and select suggested products from the Festo range.



Vacuum selection software  
[www.festo.com/en/engineering](http://www.festo.com/en/engineering)

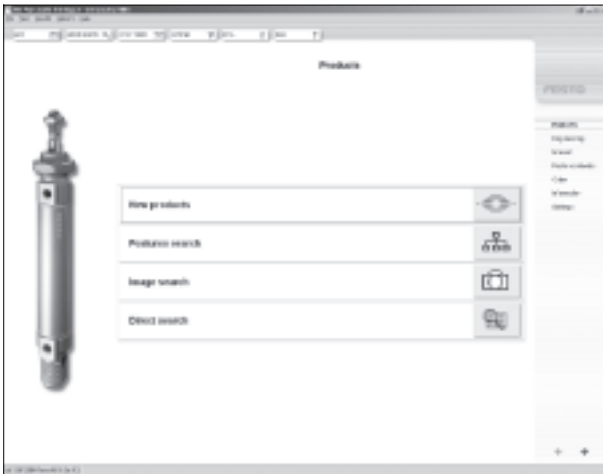

Software tool: Vacuum selection



Selection program for calculating the mass of the workpiece



Program for selecting the suction gripper

# Basic principles of vacuum technology

Introduction

## Problem definition

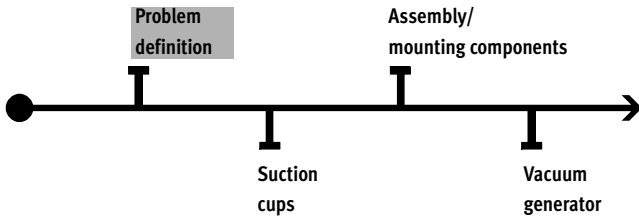

A workpiece of mass  $X$  is to be transported from point 1 to point 2 using a vacuum system. Specifications for the workpiece and general conditions for the vacuum system are listed in the section below (assumed values) and should be referred to when performing the necessary calculations.

Vacuum system, comprising:

- Suction cups
- Assembly/mounting attachments
- Vacuum generator

We need to find out which vacuum system from the Festo product range is the right one for this application. To do this, we need certain values or forces (required values).

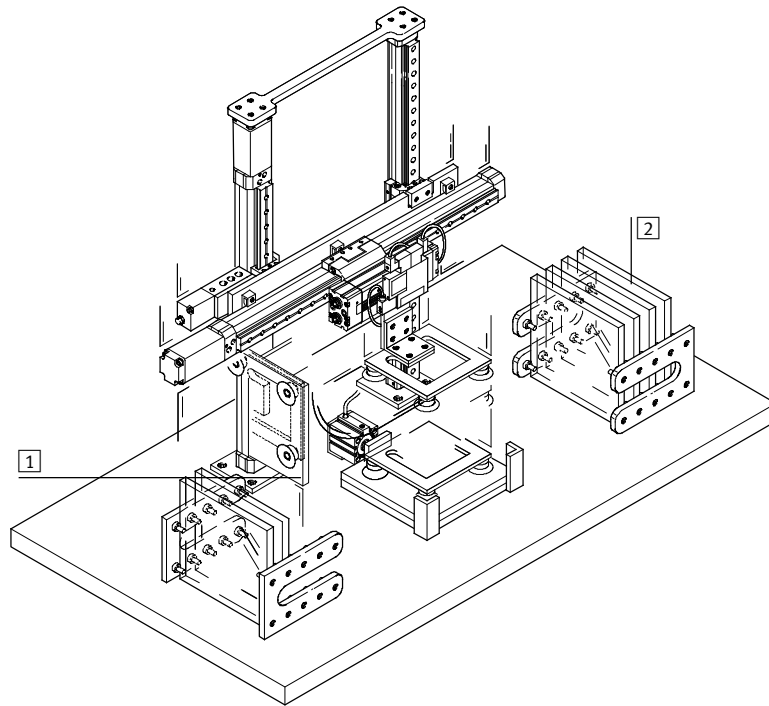

## Assumed values

For the workpiece		For the handling system	
Material	Sheet steel	Compressed air supply	6 bar
Surface	Even, smooth, slightly oily (e.g. from the press)	Directions of movement	Lift vertically Travel horizontally 90° Rotate Travel vertically
Dimensions	Length: 200 mm	Max. acceleration	5 m/s <sup>2</sup>
	Width: 100 mm	Cycle time	max. 3.5 s
	Height: 2 mm	Time requirements	For picking up: < 0.5 s For setting down: 0.1 s
		Safety factor	1.5
		Design conditions	2 suction grippers for vibration-free transport; spring-action picking up/setting down of the workpiece; vacuum line ports at side; suction grippers mounted using male threads.

## Required values

The values specified below must be calculated to determine the correct vacuum system. Other general conditions must be taken into account here. The following sequence is recommended:

- Mass (weight) of the workpiece
- Holding force and force of acceleration
- Total volume
- Cycle time

Other general conditions

- Material and surface finish
- Height and angle compensation
- Costs

# Basic principles of vacuum technology

Introduction

## Selection of suction cups

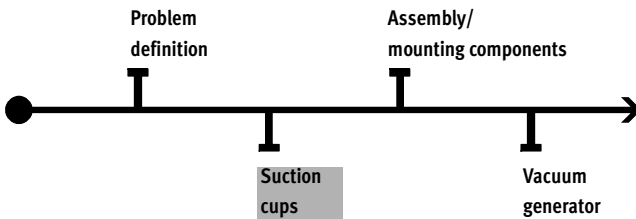

## Check list

Load	Workpiece surface	Suction cup material	Forces
What does the workpiece weigh?	What kind of surface finish does the workpiece have?	What requirements must the vacuum generator fulfil? <ul style="list-style-type: none"> <li>• Areas of application</li> <li>• Resistance requirements, temperature</li> </ul>	What kind of loads do the suction grippers have to carry? <ul style="list-style-type: none"> <li>• Holding forces – load cases in the various directions of movement</li> <li>• Breakaway force – determining the breakaway force per suction cup (definition of suction cup diameter)</li> </ul>

## Step 1: Calculating the mass m of the workpiece

$$m = L \times W \times H \times \rho$$

Example:

$$m = 20 \text{ cm} \times 10 \text{ cm} \times 0.2 \text{ cm} \times 7.85 \text{ g/cm}^3$$

$$m = 314 \text{ g}$$

$$m = 0.314 \text{ kg}$$

m = Mass [kg]

L = Length [cm]

W = Width [cm]

H = Height [cm]

$\rho$  = Density [g/cm<sup>3</sup>]

## Step 2: Selection of the suction gripper

According to the surface finish of the workpiece

Different suction cup shapes are recommended for the suction gripper, depending on the surface finish of the workpiece:

Standard suction cup

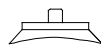

- For flat and slightly undulating surfaces, e.g. sheet metal or cartons.

Extra deep suction cup

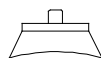

- For round or deeply undulating workpieces

Oval suction cup



- For narrow, oblong workpieces such as profiles and pipes

Bellows

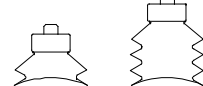

- For inclined surfaces, from 5 to 30° depending upon suction cup diameter
- Undulating, round surfaces, flexible workpieces with large surface areas
- Fragile workpieces such as glass bottles
- Use as a cost-effective height compensator

## Result

If, in the sample exercise, we were using sheet steel with an even, smooth surface, a standard suction cup would be the best solution.

# Basic principles of vacuum technology

Introduction

## Step 2: Selection of the suction gripper

According to the material quality of the workpiece

Depending on the application, the following conditions need to be taken into consideration:

- Continuous load in multiple shift operation

- Life expectancy
- Environment (e.g. chemically aggressive media, temperatures)

There are different material designs available, such as:

- For smooth or rough surfaces

- For high temperatures
- Antistatic design for electronics components

	Material properties	Nitrile rubber	Polyurethane	Polyurethane (heat-resistant)	Silicone	Fluoro rubber	Butadiene rubber (anti-static)
	Material code	N	U	T	S	F	NA
	Colour	Black	Blue	Red-brown	White transparent	Grey	Black with white dot
→	Resistance to wear/ resistance to abrasion	**	***	***	*	**	**
Areas of application							
	Very high stress	–	*	*	*	–	–
	Food processing	–	–	–	*	–	–
→	Oily workpieces	*	*	***	–	*	*
	High ambient temperatures	–	–	–	*	*	–
	Low ambient temperatures	–	*	*	*	–	–
→	Smooth surface (glass)	*	*	*	–	*	–
	Rough surface (wood, stone)	–	*	**	–	–	–
	Antistatic	–	–	–	–	–	*
	Minimal marking	–	*	*	*	–	–
Resistance							
→	Weather	*	**	**	***	***	**
	Resistance to tearing	**	***	***	*	**	**
	Permanent deformation	**	*	**	**	***	**
	Mineral based hydraulic oil	***	***	***	–	***	–
	Synthetic ester based hydraulic oil	*	–	–	–	*	–
	Non-polar solvents (e.g. white spirit)	***	**	**	–	***	–
	Polar solvents (e.g. acetone)	–	–	–	–	–	–
	Ethanol	***	–	–	***	*	–
	Isopropanol	**	–	–	***	***	–
	Water	***	–	–	**	**	–
	Acid (10%)	–	–	–	*	***	–
	Alkaline (10%)	**	*	*	***	**	–
	Temperature range, long-term [°C]	–10 ... +70	–20 ... +60	–10 ... +80	–30 ... +180	–10 ... +200	–10 ... +70
	Shore hardness A [°]	50 ±5	60 ±5	72 ±5	50 ±5	60 ±5	50 ±5
Special features							
		Low-cost	Wear resistant	Oil resistant	Approved for use in the food industry	Chemical and temperature resistant	Antistatic
Area of application							
		Conventional application	Rough surface	Automobile industry	Food industry	Glass industry	Electronics industry

\*\*\* Very suitable  
\*\* Fairly suitable

\* Suitable  
– Not suitable

## Result

For the workpiece in the problem example we would choose a suction cup made from polyurethane (material code U).

# Basic principles of vacuum technology

Introduction

## Step 3: Calculating the holding force and breakaway force

### Determining the holding force

To determine the holding force you need to know the mass of the workpiece, on the one hand, and the acceleration, on the other.



Note

The forces of acceleration that operate in a fully automatic system must be taken into consideration when designing a suction gripper system.

### Case 1

Horizontal suction gripper position, vertical direction of movement (best case)

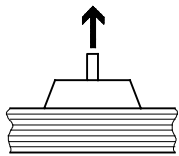

$$F_H = m \times (g + a) \times S$$

Example:

$$F_H = 0.314 \text{ kg} \times \left(9.81 \frac{\text{m}}{\text{s}^2} + 5 \frac{\text{m}}{\text{s}^2}\right) \times 1.5$$

$$F_H \approx 7 \text{ N}$$

### Case 2

Horizontal suction gripper position, horizontal direction of movement

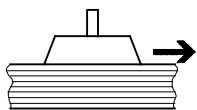

$$F_H = m \times \left(g + \frac{a}{\mu}\right) \times S$$

Example:

$$F_H = 0.314 \text{ kg} \times \left(9.81 \frac{\text{m}}{\text{s}^2} + \frac{5 \frac{\text{m}}{\text{s}^2}}{0.1}\right) \times 1.5$$

$$F_H \approx 28 \text{ N}$$

### Case 3

Vertical suction gripper position, vertical direction of movement (worst case)

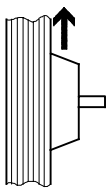

$$F_H = \left(\frac{m}{\mu}\right) \times (g + a) \times S$$

Example:

$$F_H = \left(\frac{0.314 \text{ kg}}{0.1}\right) \times \left(9.81 \frac{\text{m}}{\text{s}^2} + 5 \frac{\text{m}}{\text{s}^2}\right) \times 2$$

$$F_H \approx 93 \text{ N}$$

Result:

In accordance with the problem definition, the result of 93 N from Case 3 must be taken into account, as the system also transports the workpiece in a vertical suction gripper position with vertical force.

This value must be used for designing the system.

$F_H$  = Theoretical holding force of the suction gripper [N]  
 $m$  = Mass [kg]  
 $g$  = Acceleration due to gravity [9.81 m/s<sup>2</sup>]

$a$  = Acceleration of the system [m/s<sup>2</sup>]  
 Note the emergency off acceleration.

$S$  = Safety factor (minimum value is a safety factor of 1.5, for critical, non-uniform or porous materials or rough surfaces the factor should be 2.0 or higher)

$\mu$  = Friction factor<sup>1)</sup>  
 0.1 for oily surfaces  
 0.2 ...0.3 for wet surfaces  
 0.5 for wood, metal, glass, stone ...  
 0.6 for rough surfaces

1) The specified friction factors are average values and should be verified for the workpiece in question.

# Basic principles of vacuum technology

Introduction

## Step 3: Calculating the holding force and breakaway force

Determining the breakaway force

$F_A$  = Theoretical breakaway force [N]

$F_H$  = Theoretical holding force of the suction gripper [N]  
(Result → 45)





$n$  = Number of suction grippers  
(2 suction grippers are planned in the problem example)

$$F_A = \frac{F_H}{n}$$

Example:

$$F_A = \frac{93 \text{ N}}{2}$$

$$F_A \approx 47 \text{ N}$$

Breakaway force $F_A$ dependent on suction cup diameter and suction cup shape									
Round suction cup		$F_A$ at -0.7 bar				Oval suction cup		$F_A$ at -0.7 bar	
Ordering data	Suction cup $\varnothing$ [mm]	Standard 	Extra deep 	Bellows, 1.5 convolutions 	Bellows, 3.5 convolutions 	Ordering data	Suction cup size [mm]	Oval 	
→ ess	2	0.1 N				→ ess	4x10	2 N	
	4	0.4 N					4x20	3.4 N	
	6	1.1 N					6x10	2.9 N	
	8	2.3 N					6x20	5.9 N	
	10	3.9 N			4.7 N		8x20	8 N	
	15	8.5 N	9.8 N				8x30	10.9 N	
	20	16.3 N	17 N	12.9 N	8.2 N		10x30	15.2 N	
	30	40.8 N	37.2 N	26.2 N	20.8 N		15x45	32 N	
	40	69.6 N	67.6 N	52.3 N	42.4 N		20x60	62.8 N	
	50	105.8 N	103.6 N	72.6 N	63.4 N		25x75	92.5 N	
	60	166.1 N	162.5 N				30x90	134.4 N	
	80	309.7 N	275 N	213.9 N					
	100	503.6 N	440.8 N						
	150	900 N							
200	1,610 N								

Breakaway force  $F_A$  too low



Reliable range for the problem example



Suction cup diameter too big for workpiece

In this example we opt for 2 suction grippers:

- Round design
- Suction cup diameter 40 mm
- Breakaway force of 69.6 N

-  - Note  
The load capacity of the vacuum suction gripper must be greater than the calculated value.

# Basic principles of vacuum technology

Introduction

## Selecting assembly/mounting attachments

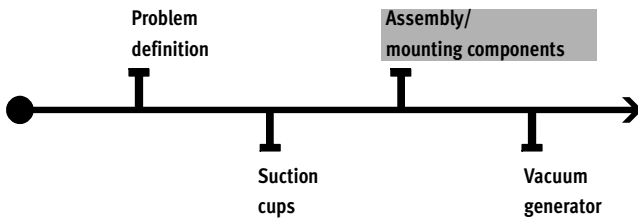

### Check list

Workpiece	Vacuum port	Type of connection	Type of mounting
Consideration of the workpiece surface <ul style="list-style-type: none"> <li>• Angle compensator for very uneven surfaces</li> <li>• Spring-mounted holders for sensitive workpieces as well as varying pick-up heights</li> </ul>	Positioning of the vacuum tubing <ul style="list-style-type: none"> <li>• top</li> <li>• at side</li> </ul>	Selecting the vacuum port for the suction cup holder <ul style="list-style-type: none"> <li>• Thread, push-in connector, barbed fitting</li> </ul>	Mounting the suction cup holder on the handling unit, e.g. robot arm <ul style="list-style-type: none"> <li>• Female/male thread</li> </ul>

## Selecting the suction cup holder

The suction cup holder as well as the “angle compensator” and “vacuum filter” accessories are selected on the basis of the previously defined suction cup diameter. According to the problem example, the workpieces must be picked up and set down with the aid of a spring. The vacuum lines should be attached at the side using push-in connectors.

The suction grippers should be mounted with external threads.

- Spring-loaded holders: In the event of excess stroke and height tolerances, it is recommended that you use a holder with a height compensator – the same applies for sensitive workpieces that need to be placed gently and with the aid of a spring.

- Choice of vacuum ports [1]:
  - top
  - at side
- 3 connection types [1]:
  - Push-in connector QS
  - Barbed fitting PK
  - Thread G
- Different mounting threads for holder [2]:
  - Female thread
  - Male thread

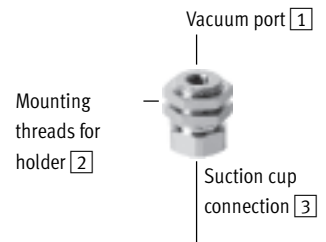

## Round suction cup

From problem example															
Suction cup Ø [mm]	2	4	6	8	10	15	20	30	40	50	60	80	100	150	200
Holder size	1		2		3		4			5			6		
Suction cup connection [3]	3 mm		4 mm		M4x0.7		M6x1			M10x1.5			M20x2		
Ordering data	→ esh														









## Oval suction cup

Suction cup size [mm]	4x10	4x20	6x10	6x20	8x20	8x30	10x30	15x45	20x60	25x75	30x90
Holder size	4						5				
Suction cup connection [3]	M6x1						M10x1.5				
Ordering data	→ esh										

# Basic principles of vacuum technology

Introduction

FESTO

Holder type									
From problem example ↓									
									
		HA	HB	HC	HCL	HD	HDL	HE	HF
→	Height compensation	-	-					-	
Vacuum port <span style="border: 1px solid black; padding: 0 2px;">1</span>									
	Top		-			-	-		
→	At side	-		-	-			-	-
→	Threaded connection G								
	Push-in connector QS							-	-
	Barbed fitting PK							-	-
Mounting threads for holder <span style="border: 1px solid black; padding: 0 2px;">2</span>									
	Female thread	-		-	-	-	-	-	-
→	Male thread		-						

## Result

Taking all requirements into account:

Suction cup holder HD, size 4





# Basic principles of vacuum technology

Introduction

## Selecting vacuum generators

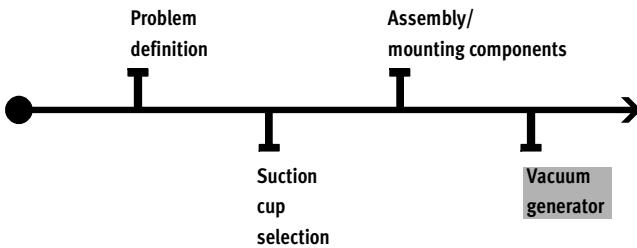

The criteria referred to in the check list therefore play an important role in the selection of a suitable ejector.

- Total volume
- Cycle time
- Economy
- Functions
- Design specifications

 Note

Almost all Festo vacuum ejectors achieve a vacuum level of approx. 85%, with the exception of the new VN ejectors, which are specially designed for low pressure of approx. 50%.

All ejectors can thus be used for handling tasks involving light to heavy workpieces or loads.

## Check list

Total volume	Cycle time	Economy	Functions
How high is the total volume to be drawn in? <ul style="list-style-type: none"> <li>• Take into account the suction cup volume</li> <li>• Take into account the suction cup holder volume</li> <li>• Calculate the tube volume</li> </ul>	How long does an operation cycle take? <ul style="list-style-type: none"> <li>• Calculate the evacuation time</li> <li>• Determine the handling/return time</li> <li>• Calculate the air supply time</li> </ul>	How high are the energy costs? <ul style="list-style-type: none"> <li>• Calculate the energy costs based on the air consumption and number of operation cycles</li> </ul>	What additional functions should the vacuum generator have? <ul style="list-style-type: none"> <li>• Filters, controls, non-return valves, vacuum switches, exhaust function, etc.</li> </ul>

## Design specifications

What specifications exist?

- Dimensions, weight, mounting position, etc.

# Basic principles of vacuum technology

Introduction

FESTO

## Step 1: Determining the total volume of the system (volume to be drawn in)

The suction cup, holder and tube volumes must be determined and added together to form the total volume.

Suction cup volume $V_1$	Suction cup holder volume $V_2$	Tube volume $V_3$	Total volume $V_T$
<p>The suction cup volumes are specified in the datasheet for the relevant vacuum suction grippers ESG, VAS, VASB.</p> <p>The suction cup volume may be specified in a table or chart, depending on the product family. In our sample application we opted for 2 suction grippers:</p> <ul style="list-style-type: none"> <li>• Round design</li> <li>• Suction cup diameter 40 mm</li> <li>• Breakaway force of 69.6 N</li> </ul> <p>For these suction cups, the datasheet specifies a suction cup volume of 1,566 mm<sup>3</sup> per suction cup.</p> <p><b><math>V_1 = 2 \times 1,566 \text{ mm}^3 = 3,132 \text{ mm}^3</math></b></p>	<p>Because of the huge range of different holder types and connection options, tables listing all of the suction cups and their relevant volumes have been created in the datasheet for the ESG product family.</p> <p>In our sample application we chose the following suction cup holders:</p> <ul style="list-style-type: none"> <li>• Suction cup holder HD Size 4 with QS connector</li> </ul> <p><b><math>V_2 = 678 \text{ mm}^3</math></b></p>	<p>Once the suction cups, suction cup holders and connection options have been defined, the tube volume can be determined.</p> <p>Tubing PUN: Outside/inside <math>\varnothing</math> [mm] 3.0/2.1 4.0/2.6 6.0/4.0 8.0/5.7 10.0/7.0</p> <p>The following formula must be used when calculating the volume:</p> $V_3 = \pi \times \frac{D^2}{4} \times L$ <p>D = Tube inside <math>\varnothing</math> [mm] L = Tube length [mm]</p> <p>In the sample application a suction cup holder with QS-6 couplings is used. A tube with an outside diameter of 6 mm is therefore required. In order to connect the vacuum generator to both suction cups, a tube length (L) of approx. 1 m (1,000 mm) is required.</p> $V_3 = \pi \times \frac{4^2}{4} \times 1\,000$ <p><b><math>V_3 = 12\,566 \text{ mm}^3</math></b></p>	$V_T = V_1 + V_2 + V_3$ $V_T = 3,132 + 678 + 12,566$ $V_T = 16,376 \text{ mm}^3 \text{ (16.38 cm}^3\text{)}$

# Basic principles of vacuum technology

Introduction

## Step 2: Determining the cycle time

$T_C$  = Evacuation time  $t_E$  + handling time  $t_1$  + air supply time  $t_S$  + return time  $t_2$

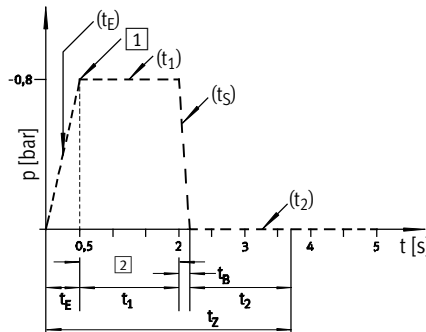

- $t_E$  = Evacuation time
- $t_1$  = Transport
- $t_S$  = Discharge
- $t_2$  = Return
- 1 = Pick-up
- 2 = Time saved

An operation cycle can be subdivided into individual time intervals, which must be either measured or calculated. The individual times added together produce the cycle time.

### Evacuation time $t_E$

The evacuation time, i.e. the time taken for a volume to reach a certain vacuum level, is very useful for assessing the performance of a vacuum generator. The evacuation

time can be found in the datasheet of the relevant vacuum generator. This example depicts charts for some of the vacuum generators of the VN-... product family.

Calculation:  
In Step 1 of the sample application we determined a total volume for the vacuum system of  $V_T = 16.38 \text{ cm}^3$  ( $17 \text{ cm}^3$ ). Using a basic rule of three, we can now calculate the evacuation time  $t_E$  for this system with any vacuum generator. According to the problem definition,  $t_E < 0.5 \text{ s}$ , based on a vacuum level of 80%.

Example 1: VADMI-45

$$t_E = V_T \times t_{E1} / 1,000$$

$$t_E = 17 \text{ cm}^3 \times 25 \text{ s} / 1,000 \text{ cm}^3$$

$$t_E = 0.425 \text{ s (0.43 s)}$$

Example 2: VADMI-70

$$t_E = V_T \times t_{E1} / 1,000$$

$$t_E = 17 \text{ cm}^3 \times 11 \text{ s} / 1,000 \text{ cm}^3$$

$$t_E = 0.187 \text{ s (0.19 s)}$$

Example 3: VN-07-H

$$t_E = V_T \times t_{E1} / 1,000$$

$$t_E = 17 \text{ cm}^3 \times 8 \text{ s} / 1,000 \text{ cm}^3$$

$$t_E = 0.136 \text{ s (0.14 s)}$$

Evacuation time  $t_E$  for 1 litre volume at 6 bar operating pressure  $p_u$

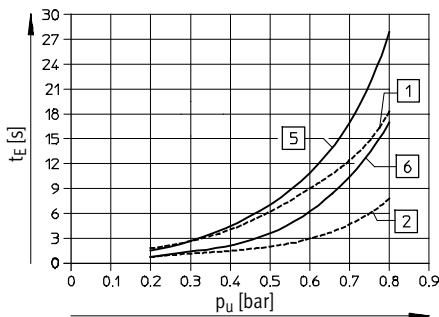

- 1 VN-05-H...
- 2 VN-07-H...
- 5 VN-05-M...
- 6 VN-07-M...

- $t_E$  = Evacuation time ( $V_T$ )
- $t_{E1}$  = Evacuation time ( $V = 1,000 \text{ cm}^3$ )
- $V_T$  = Total volume (from example)

### Handling time $t_1$

The time required to handle the workpiece after the end of the suction

process (e.g. determined using a stopwatch = 1.5 s).

### Air supply time $t_S$

Time needed by the vacuum system to build up the pressure (vacuum) again and set down the workpiece. The air supply time can be found in the technical data for the relevant vacuum generator.

The specifications apply to 1 litre volume at 6 bar operating pressure at max. vacuum level.

Using a basic rule of three, we can now calculate the air supply time  $t_S$  for this system.

- $t_S$  = Evacuation time ( $V_T$ )
- $t_{S1}$  = Evacuation time ( $V = 1,000 \text{ cm}^3$ )
- $V_T$  = Total volume (from example)

Example 1: VADMI-45

$$t_S = V_T \times t_{S1} / 1,000$$

$$t_S = 17 \text{ cm}^3 \times 1.9 \text{ s} / 1,000 \text{ cm}^3$$

$$t_S = 0.03 \text{ s}$$

Example 2: VADMI-70

$$t_S = V_T \times t_{S1} / 1,000$$

$$t_S = 17 \text{ cm}^3 \times 0.59 \text{ s} / 1,000 \text{ cm}^3$$

$$t_S = 0.01 \text{ s}$$

Example 3: VN-07-H

$$t_S = V_T \times t_{S1} / 1,000$$

$$t_S = 17 \text{ cm}^3 \times 1.1 \text{ s} / 1,000 \text{ cm}^3$$

$$t_S = 0.02 \text{ s}$$

### Return time $t_2$

The time needed by the vacuum system to return to the initial position after the workpiece has been set down (e.g. determined using a stopwatch = 1.5 s).

### Cycle time $t_C$

Example 1: VADMI-45

$$t_C = t_E + t_1 + t_S + t_2$$

$$t_C = 0.43 + 1.5 + 0.03 + 1.5$$

$$t_C = 3.46 \text{ s}$$

Example 2: VADMI-70

$$t_C = t_E + t_1 + t_S + t_2$$

$$t_C = 0.19 + 1.5 + 0.01 + 1.5$$

$$t_C = 3.2 \text{ s}$$

Example 3: VN-07-H

$$t_C = t_E + t_1 + t_S + t_2$$

$$t_C = 0.14 + 1.5 + 0.02 + 1.5$$

$$t_C = 3.16 \text{ s}$$

# Basic principles of vacuum technology

Introduction

FESTO

## Step 3: Checking economy of operation

Energy costs are determined on the basis of air consumption.

### Determining the air consumption per operation cycle $Q_C$

These charts are also included in the datasheet for the relevant vacuum generator (e.g. VADM-..., VADMI-...). The VADMI-... vacuum generators have a built-in non-return valve which maintains the vacuum after the vacuum generator has been switched off (prerequisite: there must be no leakage in the system).

When combined with the vacuum switch it provides an air-saving function, i.e. no air is consumed during transport of the workpiece. The VN-... vacuum generators do not have this function. This means, therefore, that the vacuum generator remains in operation so that it can hold the workpiece during transport.

Air consumption  $Q$  as a function of operating pressure  $p$

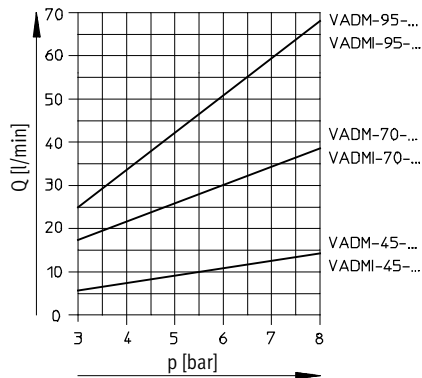

$Q_C$  = Air consumption per operation cycle  
 $t_E$  = Evacuation time for application  
 $Q$  = Air consumption per vacuum generator [l/min]

Example 1: VADMI-45

$$Q_C = t_E \times \frac{Q}{60}$$

$$Q_C = 0.43 \text{ s} \times \frac{11 \text{ l}}{60 \text{ s}}$$

$$Q_C = 0.08 \text{ l}$$

Example 2: VADMI-70

$$Q_C = t_E \times \frac{Q}{60}$$

$$Q_C = 0.19 \text{ s} \times \frac{31 \text{ l}}{60 \text{ s}}$$

$$Q_C = 0.10 \text{ l}$$

Example 3: VN-07-H

$$Q_C = (t_E + t_1) \times \frac{Q}{60}$$

$$Q_C = (0.13 \text{ s} + 1.5 \text{ s}) \times \frac{28 \text{ l}}{60 \text{ s}}$$

$$Q_C = 0.76 \text{ l}$$

### Determining the number of operation cycles per hour $Z_h$

$Z_h$  = Operation cycles per hour  
 $t_z$  = Time per operation cycle  
 $t_E$  = Evacuation time for application

Example 1: VADMI-45

$$Z_h = \frac{3,600 \text{ s}}{t_z}$$

$$Z_h = \frac{3,600 \text{ s}}{3.46 \text{ s}}$$

$$Z_h = 1,040$$

Example 2: VADMI-70

$$Z_h = \frac{3,600 \text{ s}}{t_z}$$

$$Z_h = \frac{3,600 \text{ s}}{3.2 \text{ s}}$$

$$Z_h = 1,125$$

Example 3: VN-07-H

$$Z_h = \frac{3,600 \text{ s}}{t_z}$$

$$Z_h = \frac{3,600 \text{ s}}{3.16 \text{ s}}$$

$$Z_h = 1,139$$

### Determining the air consumption per hour $Q_h$

$Q_h$  = Air consumption per hour  
 $Q_C$  = Air consumption per operation cycle  
 $C_h$  = Operation cycles per hour

Example 1: VADMI-45

$$Q_h = Q_C \times C_h$$

$$Q_h = 0.08 \text{ l} \times 1,040$$

$$Q_h = 83.20 \text{ l} (0.08 \text{ m}^3)$$

Example 2: VADMI-70

$$Q_h = Q_C \times C_h$$

$$Q_h = 0.10 \text{ l} \times 1,125$$

$$Q_h = 112.5 \text{ l} (0.12 \text{ m}^3)$$

Example 3: VN-07-H

$$Q_h = Q_C \times C_h$$

$$Q_h = 0.76 \text{ l} \times 1,139$$

$$Q_h = 865.64 \text{ l} (0.87 \text{ m}^3)$$

### Determining the energy costs per year $K_{EA}$

$K_{EA}$  = Energy costs per year  
 $Q_h$  = Air consumption per hour

Costs for compressed air<sup>1)</sup>:  
 1 m<sup>3</sup> at 7 bar: € 0.02/m<sup>3</sup>,  
 at an electricity price of  
 € 0.10/kWh

$$K_{EA} = Q_h \times \text{Compressed air costs/m}^3 \times \frac{t_{\text{operating}}}{\text{Day}} \times \frac{t_{\text{operating}}}{\text{Year}}$$

Vacuum generator	Air consumption per cycle $Q_C$ [l]	Cycles per hour $Z_h$	Air consumption per hour $Q_h$ [m <sup>3</sup> ]	Energy costs per year $K_{EA}$ <sup>2)</sup> [€]
VADMI-45	0.08	1,040	0.08	5.76
VADMI-70	0.10	1,125	0.12	8.64
VN-07-H	0.76	1,139	0.87	62.63

1) Material, depreciation and labour costs, etc. are reflected in the price

2) Energy costs for shift operation 16 hours/day and 220 days/year

# Basic principles of vacuum technology

Introduction

## Step 4: Taking additional functions/components and design specifications into account

Selecting additional functions/components:

Selection of these components is guided by specific requirements in terms of performance and functionality, as well as by the place of operation and application of the system. All details regarding performance or components are provided in the datasheet on the relevant product.

### Solenoid valves

A vacuum system needs solenoid valves for controlling vacuum generation. These switch the vacuum on and off.

Vacuum generator

- VADM-..., VADMI-...
- VAD-M-..., VAD-M...-I-...

Operation cycles can be accelerated and optimised by adding an extra valve as an ejector pulse generator.

Vacuum generator

- VADMI...-
- VADM...-I-...

 Note  
The nominal flow rate of the solenoid valve must not be lower than the suction capacity of the vacuum generator at atmospheric pressure. (Both specifications can be found in the datasheet for the relevant product.)

### Vacuum switch

- Reliability through pressure monitoring
- Adjustable switching point
- Fast hysteresis adjustment
- Digital/analogue signal output
- Display
- Ports

### Filter

- Reliability: no contamination of the system

- Extension of the product life cycle and reduction of maintenance intervals

### Pressure gauge

- Manual pressure monitoring of the system
- Safety function

### Silencers

- Noise pollution kept to a minimum

## Taking design specifications into account

The following design specifications must be taken into account when configuring a vacuum system:

- Size
- Weight
- Resistance

### Calculation example summary

The cycle time and economy of the ejectors were used as selection criteria.

#### Selection of suction cups

Taking the mass and force calculations plus all criteria into account, we get the following result:

Quantity	2 units
Design	round
Suction cup $\varnothing$	40 mm
Breakaway force	69.4 N
Material	Polyurethane

#### Selecting assembly and mounting attachments

The result takes all system requirements into account:

Holder type	HD
Size	4

#### Selecting vacuum generators

We compared three vacuum generators chosen at random from the Festo product range:

Compact ejectors	VADMI-45
	VADMI-70
Inline ejectors	VN-07-H

### Result

Compact ejector VADMI-45

#### Cycle time

All three vacuum generators lay within a reasonable timeframe in the sample application and were below the maximum time of 3.5 seconds specified in the problem definition.

#### Economy

The vacuum generator VADMI-45 came off best in terms of energy consumption and, consequently, energy costs. The two compact ejectors VADMI-45 and VADMI-70 produced almost identical results in relation to energy costs. Although the larger VADMI-70 has a somewhat higher air consumption per unit of time, it can generate the vacuum faster.

The VADMI-45, on the other hand, has a smaller nozzle diameter and thus significantly lower air consumption. However, it cannot generate the vacuum as quickly as the VADMI-70. The number of cycles per unit of time and the quantities are almost identical for all three vacuum generators.

# Basic principles of vacuum technology

Introduction

FESTO

## Products for vacuum technology

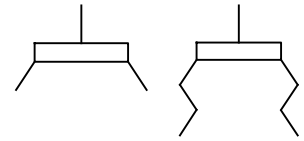
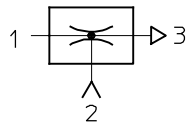

### Vacuum generator

A vacuum ejector is the central element of any vacuum system. Festo offers an extensive range of vacuum ejectors for all kinds of applications and performance requirements:

#### Basic and inline ejectors

Vacuum generators

VN-..., VAD-.../VAK-...

#### Compact ejectors

Vacuum generators

VADM-.../VADMI-...,

VAD-M.../VAD-M...-I-...

### Vacuum suction gripper

The suction grippers are the connecting element between the vacuum system and the workpiece.

Given the huge variety of surface finishes, shapes and temperatures as well as different workpiece masses, a comprehensive range of suction cups and possible combinations is needed. With its suction cup range and the modular suction gripper ESG, Festo has a solution for every application:

#### Modular suction gripper ESG-...

Suction cups VAS-.../VASB-...

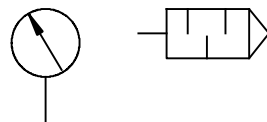

### Vacuum accessories

Controlling, measuring, checking, filtering, etc. are important functions which, if not already included as standard in a vacuum system, can be added through an extensive range of accessories.

#### Vacuum security valve ISV-...

#### Vacuum gauges VAM-...

#### Vacuum filters VAF-...

#### Vacuum switches VPEV-...

Other accessories:

Height compensators, adapters

Tubing

QS push-in fittings