

# Terminal CPX

## Input module CPX-F8DE-P

# FESTO

Description

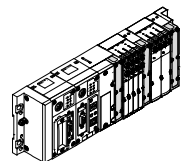
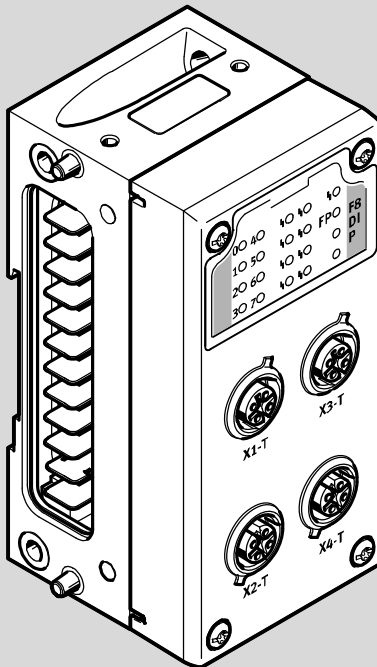

8035497  
en 2005b  
[8135881]



Translation of the original instructions

Original ..... en

Edition ..... en 2005b

Identifier ..... CPX-F8DE-P-EN

Order no. .... 8035497

© (Festo SE & Co. KG, Postfach, 73726 Esslingen, Germany, 2020)

Internet: [www.festo.com](http://www.festo.com)

E-Mail: [service\\_international@festo.com](mailto:service_international@festo.com)

Reproduction, distribution or sale of this document or communication of its contents to others without express authorisation is prohibited. Offenders will be liable for damages. All rights are reserved, in particular the right to file patent, utility model or registered design applications.

CAGE CLAMP®, PI PROFIBUS PROFINET®, SIEMENS® are registered trademarks of the trademark owners in specific countries.

## Contents

General safety instructions .....	VI
Intended use .....	VII
Rules for product configuration .....	VIII
Foreseeable misuse .....	X
Achievable safety rating .....	XI
Failures due to a common cause (Common Cause Failure – CCF) .....	XIII
Requirements for product use .....	XIII
Transport and storage conditions .....	XVI
Service .....	XVI
Range of application and approvals .....	XVI
Specified directives and standards .....	XVIII
Product identification .....	XVIII
Information regarding this description .....	XXI
Important user information .....	XXII
Product-specific terms and abbreviations .....	XXIV
<b>1. System overview CPX-F8DE-P .....</b>	<b>1-1</b>
1.1 CPX terminal with CPX-F8DE-P .....	1-3
1.1.1 Design of the input module .....	1-3
1.1.2 Components .....	1-4
1.1.3 Supported CPX product versions .....	1-9
1.1.4 Required bus topology (control chain) .....	1-11
1.2 PROFIsafe .....	1-12
1.2.1 PROFIsafe safety profile .....	1-12
1.2.2 Process image (I/O image) .....	1-13
1.2.3 Bit pattern of the output and input data (F usage data) .....	1-14
1.2.4 Channel-wise passivation .....	1-16
1.3 Mode of operation of the input module .....	1-18
1.3.1 Safe system status .....	1-19
1.3.2 Overview of applications .....	1-19
1.3.3 Details of the function modes .....	1-21
1.3.4 Use of clock signals .....	1-40
1.3.5 Channel bundling .....	1-41

1.4	Application examples	1-42
1.4.1	Control desk	1-42
1.4.2	Rotary indexing table	1-44
1.4.3	Limit position switch	1-46
1.4.4	Light curtain	1-47
1.4.5	Acknowledge button with request	1-48
1.4.6	2 two-wire sensors	1-49
1.4.7	2 safety doors on one channel pair	1-49
1.4.8	Safety door with two N/O switches	1-50
<b>2.</b>	<b>Installation</b>	<b>2-1</b>
2.1	General information about installation	2-3
2.1.1	Module-related rules for configuration	2-4
2.2	Electrical connection and display elements	2-5
2.2.1	Pin allocation on the manifold block CPX-M-AB-4-M12X2-5POL-T	2-6
2.2.2	Pin allocation on the manifold block CPX-M-AB-4-M12X2-5POL	2-7
2.2.3	Pin allocation on the manifold block CPX-AB-8-KL-4POL	2-8
2.3	Installation of the electronics module	2-9
2.3.1	Disassembling the electronics module	2-10
2.3.2	Installing the electronics module	2-10
2.4	Setting the PROFIsafe address	2-11
2.5	Connection of sensors	2-13
2.5.1	Ensuring the degree of protection	2-14
<b>3.</b>	<b>Commissioning</b>	<b>3-1</b>
3.1	General information	3-3
3.2	Device master file (GSDML and GSD)	3-4
3.3	Module identification	3-4
3.4	Preparing for commissioning	3-5
3.5	Commissioning steps	3-6
3.6	Setting the PROFIsafe parameters	3-7
3.7	Reading out the CPX module parameters	3-9
3.7.1	Parameter and signal display with the operator unit CPX-MMI-1	3-11

3.8	Configuration with Siemens STEP 7 (example) . . . . .	3-13
3.8.1	Addressing example . . . . .	3-16
<b>4.</b>	<b>Operation . . . . .</b>	<b>4-1</b>
4.1	LED status indication . . . . .	4-3
4.1.1	Behaviour during the start-up phase (Startup) . . . . .	4-4
4.1.2	Normal operating status . . . . .	4-4
<b>5.</b>	<b>Diagnostics and error handling . . . . .</b>	<b>5-1</b>
5.1	Overview . . . . .	5-3
5.2	Error characteristics . . . . .	5-4
5.3	Diagnostics using LEDs . . . . .	5-6
5.3.1	Behaviour in response to original module errors . . . . .	5-10
5.3.2	Behaviour in response to channel errors . . . . .	5-11
5.4	Diagnostics via the bus node . . . . .	5-13
5.4.1	Diagnostics with the operator unit CPX-MMI . . . . .	5-13
<b>6.</b>	<b>Service, repair, disposal . . . . .</b>	<b>6-1</b>
6.1	Maintenance . . . . .	6-3
6.2	Repair . . . . .	6-3
6.3	Disposal . . . . .	6-4
<b>A.</b>	<b>Technical appendix . . . . .</b>	<b>A-1</b>
A.1	Technical data . . . . .	A-3
A.1.1	Safety characteristics . . . . .	A-3
A.1.2	Characteristic values of the input module . . . . .	A-5
A.2	Technical data of the manifold blocks . . . . .	A-8
<b>B.</b>	<b>Supplementary information / Index . . . . .</b>	<b>B-1</b>

## General safety instructions



### Warning

Disregarding the safety instructions can result in death, serious injuries or major material damage.

- Observe the safety instructions and warnings.
- Refer to the brief description for technical safety requirements → P.BE-CPX-F8DE-P-...



### Note

Electronics modules include electrostatically sensitive devices. Incorrect handling can cause damage to the electronics modules.

- Observe the handling specifications for electrostatically sensitive devices.
- Discharge static electricity from your body to protect the modules before assembling or disassembling modules.



Observe the instructions for the electrical supply (Protective Extra-Low Voltage, PELV) of CPX terminals in the CPX system description P.BE-CPX-SYS-...



## Intended use

The input module CPX-F8DE-P is intended for reliable recording and evaluation of signals of connected sensors.

The input module provides up to eight secure inputs that can be used by a higher-order safety controller in a safety function. The communication with the higher-level safety control is implemented by the safe PROFIsafe protocol via a PROFIBUS or PROFINET IO fieldbus connection.

The inputs on the input module can be combined for multi-channel sensor applications. Every two inputs form a channel pair, which is set separately with one of 11 function modes. The function modes influence the evaluation of input signals and optionally the generation of clock signals.

The characteristics of the inputs comply with standard IEC 61131-2 for Type 2 digital inputs.

The input module CPX-F8DE-P is a product with safety-relevant functions. The input module is intended for installation in machines or automation-technology systems and may be used only as follows:

- in excellent technical condition
- in its original condition, without unauthorised modifications
- exclusively in the configurations specified in this description → Chapter 1.3.3
- within the limits of the product as defined by the technical data → Appendix A.1
- in an industrial environment



**Note**

- Note that the safety engineering system limits of the product are also its physical limits.

The user is responsible for use of the input module in a safety function.

**Rules for product configuration**

Operation of the input module CPX-F8DE-P is permissible exclusively in CPX terminals.

Operation of the CPX-F8DE-P is permissible only in combination with the following PROFIsafe-compatible bus nodes:

Bus node	From revision	Network protocol
CPX-FB13 <sup>1)</sup>	30	PROFIBUS
CPX-FB33 <sup>2)</sup>	21	PROFINET IO
CPX-M-FB34 <sup>2)</sup>	21	PROFINET IO
CPX-M-FB35 <sup>2)</sup>	21	PROFINET IO
CPX-FB43 <sup>2)</sup>	50	PROFINET IO
CPX-M-FB44 <sup>2)</sup>	50	PROFINET IO
CPX-M-FB45 <sup>2)</sup>	50	PROFINET IO
1) → Description CPX-FB13...		
2) → Operating instructions CPX-(M)-FB33/34/35/43/44/45...		

Tab. 0/1: Permissible PROFIsafe-compatible CPX bus nodes

- Use exclusively metal interlinking blocks – e.g. CPX-M-GE-EV → Chapter 1.1.2.
- Comply with all technical data → Appendix A.1. Otherwise malfunctions may occur.

The CPX-F8DE-P may only be operated with the following manifold blocks:

<b>Manifold block</b>	<b>Application examples</b>
CPX-M-AB-4-M12X2-5POL-T	Connection of OSSD sensors with a current consumption of up to 0.7 A – Power supply via contacts T0, T2, T4, T6 Connection of sensors for mechanical switch contacts – Clock signals via contacts T0 ... T7
CPX-M-AB-4-M12X2-5POL	Connection of OSSD sensors with a current consumption of up to 2 A
CPX-AB-8-KL-4POL	Connection of sensors via the terminal strip
CPX-AB-ID-P	Setting of a coded identifier using an 8x DIL switch – It is not possible to connect sensors

Tab. 0/2: Permissible manifold blocks



For more information about the supported product versions of CPX see Chapter 1.1.3.

## Foreseeable misuse

The following foreseeable misuses are among those not approved as intended use:

- use outdoors
- use in non-industrial areas
- use outside the limits of the product defined in the technical data
- use with inappropriate function modes
- unauthorised modifications.



### Note

The use of manifold and interlinking blocks that are not listed is **not permissible** → Tab. 1/1 and Tab. 1/3.



### Note

The use of the input module CPX-F8DE-P for implementation of safety circuits is **not permissible** in the following cases:

- in a CPX terminal equipped with CPX-FEC or CPX-CEC
- in a CPX terminal of variant P
- in configurations other than those listed  
→ Chapter 1.3.3, Function modes.



### Note

In the event of damage caused by unauthorised manipulation or any form of use other than the intended use, the warranty will be invalidated and the manufacturer will not be liable for damages.

## Achievable safety rating

The CPX-F8DE-P can be used to implement safety functions up to:

- Performance Level e, Cat. 4 in accordance with EN ISO 13849-1
- Safety Integrity Level SIL 3 in accordance with EN 61508
- Performance Limit SIL CL 3 in accordance with EN 62061

The attainable safety classification of the overall safety device depends on the set function mode as well as other components used to implement the safety function.

- Make sure that the overall safety function of the system is analysed and validated.  
It is the responsibility of the operator to determine and verify the required safety classification (safety integrity level, performance level and category) of the system.
- Be aware of the residual risks that remain in your system despite the measures to integrate safety in the design, despite safety precautions and despite the supplementary protective measures.  
The residual risks are determined, among other things, by your safety regulations and the safety characteristics of your system.



**Information on compliance with a safety classification**

- Test the functionality of the safety device at adequate intervals.

Recommended:

- at least 1x per year for PL d
- at least 1x per month for PL e

The operator is responsible for selection of the type of test and the time intervals between the tests.

- Conduct the tests in order to ensure that the smooth functioning of the safety device is verified and documented in interaction with all components.
- Ensure that, after each safety request due to a self-diagnostic test, the system undergoes troubleshooting and a restart under the supervision of the personnel responsible.

## Failures due to a common cause (Common Cause Failure – CCF)

Common cause failures cause the loss of the safety function, since all channels in a multichannel system fail simultaneously.

The following measures ensure that common cause failures are avoided:

- Comply with operating voltage range
- Comply with signal voltage range
- Comply with temperature and environmental conditions

The application may result in additional measures to avoid common cause failures.

## Requirements for product use

- Make this description available to the design engineer, installation technician and personnel responsible for commissioning the machine or system in which this product is used.
- Make sure that the specifications in the documentation are observed at all times. Also comply with the documentation for the other components and modules (e.g. bus nodes, pneumatics, etc.).
- Take into consideration the legal regulations applicable for the location as well as:
  - instructions and standards
  - regulations of the testing organisations and insurers
  - national specifications.
- Remove all packaging, such as foils, caps and cardboard. The material used in the packaging has been specifically chosen for its recyclability (exception: oiled paper = residual waste).

- Assembly must be performed in a professionally correct manner.

To maintain the IP degree of protection:

- screw the manifold block tightly to seal it → Chapter 2.3
- assemble cable entries and seals in a professionally correct manner
- seal unused connections with cover caps.

### Technical prerequisites

General technical prerequisites for correct and safe use of the product:

- Comply with all limits of the product defined by the technical data → Appendix A.1.  
Only then is operation of the product ensured in accordance with the relevant safety regulations.
- When connecting standard auxiliary components, also observe the specified limit values for electrical connection values and ambient conditions.



### Training of qualified personnel

The device may only be commissioned by trained, qualified control and automation technology personnel, who are familiar with:

- the installation and operation of control systems
- the applicable instructions for operating safety engineering systems
- the applicable instructions for accident prevention and occupational safety
- the documentation for the product



**Note**

Work on safety engineering systems may only be carried out by qualified personnel trained in safety engineering.

## Transport and storage conditions

- Protect the product from excessive stress factors during transport and storage, such as:
  - Mechanical loads
  - Impermissible temperatures
  - Moisture
  - Aggressive atmospheres.
- Store and transport the product in its original packaging. The original packaging offers sufficient protection from typical stresses.

## Service

- Contact your local Festo Service centre in the event of technical problems.

## Range of application and approvals

This product is a safety device as defined in the Machinery Directive 2006/42/EC and carries the CE marking.



Safety-related standards and test values with which the product complies and fulfils can be found in Technical Data, → Appendix A.1. The product-related EC directives and standards are listed in the Declaration of Conformity. The certificates and the Declaration of Conformity relating to this product can be found on the Internet → [www.festo.com/sp](http://www.festo.com/sp)

- Observe that compliance with the named standards is limited to the input module CPX-F8DE-P.

Certain configurations of the product have been certified by Underwriters Laboratories Inc. (UL) for the USA and Canada. These configurations bear the following mark:



UL Recognized Component Mark for Canada and the United States

**Only for connection to a NEC/CEC Class 2 supply.  
Raccorder Uniquement a un circuit de NEC/CEC Classe 2.**



**Note**

Observe the following if the UL requirements are to be complied with in your application:

- Regulations for complying with the UL certification can be found in the separate UL-specific special documentation. The relevant technical data in that documentation also apply with priority if they do not influence the safety engineering values in an impermissible manner.
- The technical data in this documentation may show values deviating from this.

## Specified directives and standards

Version	
EN ISO 13849-1:2008-06 + AC:2009	EN 61508 Parts 1-7:2010
EN ISO 13849-2:2012	EN 62061:2005-04 + AC:2010 + A1:2013
EN 574:1996 + A1:2008	IEC 61131-2:2007-07
EN 60529:1991 + A1:1999 + A2:2013	IEC 60204-1:2005/A1:2009 + AC:2010

Tab. 0/3: Directives and standards specified in the document

## Product identification

The product identification is the module identifier plus the product labelling. The module identifier can be seen through the transparent covering on the manifold block.

Module identifier	Meaning
	<ul style="list-style-type: none"> <li>– Module identifier <span style="border: 1px solid black; padding: 0 2px;">1</span>: F8DIP (F=Safety; 8=Number; D=Digital; I=Inputs; P=PROFIsafe)</li> <li>– Yellow backgrounds <span style="border: 1px solid black; padding: 0 2px;">2</span> for identification of the safety function</li> </ul>

Tab. 0/4: Module identifier of the input module CPX-F8DE-P

The product label of the electronics module CPX-F8DE-P shows the following information:

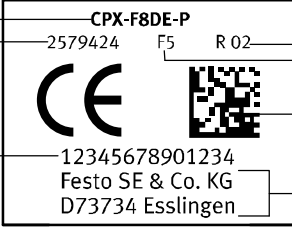
Product labelling (example)	Meaning
 <p>The image shows a product label for CPX-F8DE-P. It includes a CE mark, a QR code, and the following text: CPX-F8DE-P, 2579424, F5, R 02, 12345678901234, Festo SE &amp; Co. KG, D73734 Esslingen. Numbered callouts 1-7 point to these specific elements.</p>	<ul style="list-style-type: none"> <li>- Product designation <span style="border: 1px solid black; padding: 0 2px;">1</span></li> <li>- Part number <span style="border: 1px solid black; padding: 0 2px;">7</span><sup>1)</sup></li> <li>- Revision code (here R 02) <span style="border: 1px solid black; padding: 0 2px;">2</span></li> <li>- Serial number shown as data matrix code <span style="border: 1px solid black; padding: 0 2px;">4</span><sup>2)</sup></li> <li>- Manufacturer and manufacturer's address <span style="border: 1px solid black; padding: 0 2px;">5</span></li> <li>- 14-character serial number <span style="border: 1px solid black; padding: 0 2px;">6</span><sup>2)</sup></li> <li>- Manufacturing period (encoded) <span style="border: 1px solid black; padding: 0 2px;">3</span><sup>3)</sup> (here F5 = May 2015)</li> </ul>
<p>1) Part number of the electronics module CPX-F8DE-P.                  2) The serial number enables the product to be traced.                  3) → Tab. 0/6 and Tab. 0/7</p>	

Tab. 0/5: Product label of the electronics module CPX-F8DE-P



Further information can be found in the P.BE-CPX-SYS... system description

### Revision version

- Determining the revision status of a CPX module:
  - with the operator unit CPX-MMI-1  
→ [Module data][Revision]
  - with corresponding configuration software  
→ module data, revision code
  - from the product labelling of the relevant module  
(in dismantled condition, → Tab. 0/5).
- Before replacing a module, check that the revision code of the bus node corresponds to the requirements of the module → Tab. 0/1.

### Manufacturing period

The manufacturing period is encrypted on the product label in the form of a two-digit code → Tab. 0/5.

The letter specifies the manufacturing year and the character after it (number or letter) indicates the manufacturing month.

Manufacturing year					
X = 2009	A = 2010	B = 2011	C = 2012	D = 2013	E = 2014
F = 2015	H = 2016	J = 2017	K = 2018	L = 2019	M = 2020

Tab. 0/6: Year of manufacture (20-year cycle)

Manufacturing month			
1	January	7	July
2	February	8	August
3	March	9	September
4	April	O	October
5	May	N	November
6	June	D	December

Tab. 0/7: Manufacturing month

## Information regarding this description

This description contains general, basic information about how to operate, assemble and install the input module CPX-F8DE-P in conjunction with the CPX terminal and refers exclusively to the following revisions of the input module:

<b>This description applies to the following product</b>		
<b>Product</b>	<b>Part number</b>	<b>Revision <sup>1)</sup></b>
CPX-F8DE-P	2597424	Rxx
1) xx stands for a numeral between 01 and 99 → Tab. 0/5.		

### Tab. 0/8: Applicability

General basic information about operating, assembling, installing and commissioning CPX terminals can be found in the CPX system description.

Special information about commissioning, parameterisation and performing diagnostics on a CPX terminal with the bus node you are using can be found in the corresponding description for your bus node. Information about other CPX modules can be found in the separate description of that module.

Information about the pneumatics can be found in the corresponding pneumatics descriptions.



An overview of the user documentation structure for the CPX terminal can be found in the CPX system description P.BE-CPX-SYS-....

## Important user information

### Danger categories

This description includes information on the possible dangers that can occur if the product is used incorrectly. This information is identified by a signal word (Warning, Caution etc.), printed on a shaded background and marked with a pictogram. The following types of danger warnings are defined:



#### **Warning**

... means that non-observance can result in serious personal injury or damage to property.



#### **Caution**

... means that means that non-observance can result in personal injury or damage to property.



#### **Note**

... means that non-observance can result in damage to property.

In addition, the following pictogram marks passages in the text that describe activities involving electrostatically sensitive devices:



Electrostatically sensitive devices: incorrect handling can cause damage to devices.



## Identification of special information

The following pictograms identify passages in the text that contain special information.

### Pictograms



**Information:**  
recommendations, tips and references to other information sources.



**Accessories:**  
information about necessary or useful accessories for the Festo product.



**Environment:**  
information about environmentally friendly use of Festo products.

### Text symbols and markers

- Bullet points denote activities that can be carried out in any order.
- 1. Numbers indicate activities that must be carried out in the specified sequence.
- Arrowheads indicate general lists.

## Product-specific terms and abbreviations

Term/abbreviation	Meaning
Acknowledgement	Signal or procedure for depassivation. An acknowledgment from the user confirms that the input module can be brought back on line without danger, and/or that the input channel can be depassivised without any risk. If the complete input module is passivised (→ Module-based passivation), the acknowledgment involves standard → Reintegration (standard PROFIsafe process). If one input channel is passivised (→ Channel-based passivation), the acknowledgment signal involves the process image → Chapter 1.2.3.
Black channel	The “black channel” is the name given to a transmission route without safety engineering properties across which secure communication is possible by the addition of fail-safe mechanisms. For example, the field bus and the bus node (PROFIBUS or PROFINET IO) is part of the black channel across which PROFIsafe communication is processed.
Category	Category (cat.) is the classification of a safety-related part of a controller with respect to its resistance to errors and its subsequent behaviour after an error, which is achieved by the structural arrangement of the parts, error detection and by their reliability → EN ISO 13849-1.
Channel	→ Input channel
Channel-based passivation	Type of passivation whereby only the channel pair of the affected defective input channel is passivised. The input module remains integrated. An acknowledgement signal via the process image is required for depassivation → Chapter 1.2.4.
Clock output	Output with a specific clock signal that is directed by a sensor and is detected by a related input. This clock signal is clearly distinguished from other similar functional cycles and enables the diagnosis of cross circuits on the switched signals.
Clock signal monitoring	In the function modes with clock signal monitoring, the inputs are used to detect if the actual clock signal, an external clock signal or the sensor power supply is applied. The information is not released in the PROFIsafe input image until the anticipated clock signal has been detected.
CRC signature	Check value in the PROFIsafe security telegram to check the integrity of telegram data (Cyclic Redundancy Check).
Cross circuit	Accidental electrical connection between signals. Cross circuits falsify the signal and cause loss of the safety function.

<b>Term/abbreviation</b>	<b>Meaning</b>
Cross-circuit monitoring	Function that detects possible cross-circuiting in the circuits connected to the device and that sets a safe mode for the device and/or for the input channel affected. This may involve → cycle monitoring and/or discrepancy monitoring.
Depassivation	In the operating mode “Passivation by channel”, depassivation involves setting the Acknowledge bit in the output data → Chapter 1.3.2. In the operating mode “Passivation by module”, depassivation involves → Reintegration.
F-Device	General designation for safety-related devices → safety control unit.
F-Host	Safety control unit for controlling safety-related devices.
F-System	Safety-related system that restores a safe state in the event of dangerous system and device errors.
Forced dynamic response	Function testing procedure to determine the switching capacity of signals. The procedure is often used with outputs in the form of test pulses and on clocked inputs. Generally speaking, many safety-related signals can be found to have forced dynamic responses for detection of short circuits and cross circuits.
GSDML/GSD	Device Description File
Input channel	Input circuits in accordance with IEC 61131-2 for Type 2 digital inputs to record signals from connected sensors.
iParameters	Technology-specific individual parameters for a defined device.
Input image	→ Process image at input of safety control unit

Term/abbreviation	Meaning
Module-based passivation	<p>Type of passivation in which all channel pairs of the input module are passivised, e.g.:</p> <ul style="list-style-type: none"> <li>– in the event of errors in safety-related communications (PROFIsafe)</li> <li>– self-test errors</li> <li>– channel errors if “channel-based passivation” is switched off.</li> </ul> <p>Regular re-integration is required with “module-based passivation” (standard process of PROFIsafe for acknowledgment).</p> <ul style="list-style-type: none"> <li>– The input module sets the “Device_Fault” signal.</li> <li>– As soon as the cause of the error has been remedied, the input module automatically withdraws the “Device_Fault” signal. With errors that cannot be remedied during runtime, “Device_Fault” remains set until the next time the system is powered down.</li> <li>– To ensure that substitute values (0) continue to be transmitted once the cause of the error has been remedied, the safety control unit can transmit “Activate_FV” to the input module. The input module responds with “FV_Activated” until the safety control unit displays the “Activate_FV” signal to indicate that safe operation with process values is possible again.</li> </ul>
N/O	English abbreviation for normally open contact → Sensor
N/C	English abbreviation for normally closed contact → Sensor
OSSD	Output Signal Switching Device. Sensor with autonomous line monitoring.
Output image	→ Process image at output of safety control unit
Passivation	Safety function in which the input module CPS-F8DE-P is set to a safe status for all input channels (→ Module-based passivation) or only for defective input channels (→ Channel-based passivation). Instead of the process values → Substitute values (0) are transmitted.
Performance Level (PL ...)	Discrete characteristics level that specifies the ability of safety-related parts of a safety control unit to perform a safety function under defined conditions. Five levels are defined in EN ISO 13849-1. PL a is the lowest level and PL e is the highest level.
PROFIBUS	Standard for field bus communication between control units (SPS/IPC) and devices in automation technology (PROcess Field BUS) → <a href="http://www.profibus.com">www.profibus.com</a>
PROFINET IO	Field bus standard based on Industrial Ethernet for communication between control units (SPS/IPC) and devices → <a href="http://www.profinet.com">www.profinet.com</a>

Term/abbreviation	Meaning
PROFIsafe	<p>Safety-based bus profile for PROFIBUS and PROFINET IO that, in conjunction with PROFIsafe-compliant devices (F-Host und F-Device) facilitates correct and reliable transmission of safety messages. Mechanisms for safe transmission and error detection:</p> <ul style="list-style-type: none"> <li>– CRC signatures (data integrity test)</li> <li>– Consecutive numbering of the safety messages</li> <li>– Address data check → PROFIsafe address</li> <li>– Time monitoring.</li> </ul> <p>In the event of errors, the F-Device can automatically trigger predefined safety measures. The consecutive numbering enables the recipient to check that all messages are received in the right order. For this purpose, the F-Host and the F-Device are equipped with their own state machines, which are synchronised using a control and status byte. Correct synchronisation is monitored by incorporation of counter values in the calculation of the CRC signature.</p>
PROFIsafe address	<p>Every PROFIsafe-enabled device or module has its own unique PROFIsafe address to enable identification of the recipient of a message. The PROFIsafe address is specified in the configuration program and set with the DIL switch on the PROFIsafe-enabled device or module. Configuration errors are automatically detected by comparing the target and actual configuration.</p>
PROFIsafe monitoring time	<p>Monitoring time for safety-related communication between F-Host and F-Device</p>
Process image	<p>The process image is part of a controller's system memory. At the start of the cyclical program, the signal states of the input modules are transferred to the process image for the inputs. At the end of the cyclical program, the process image for the outputs are transferred to the output modules as the signal state.</p>
Process error	<p>The monitored sensor signals have taken an invalid combination.</p>
Reintegration	<p>Reintegration is the standard PROFIsafe process for reintegrating passivised modules.</p>
Reintegration	<p>Switching from substitute values to process values = depassivation (→ Passivation). Reintegration is a standard PROFIsafe process for depassivation of a passivised module (PROFIsafe specification).</p>
Replacement value	<p>Preset safe value that replaces the real process value or the programmed value in the event of a malfunction or when booting safety-related systems. The value 0 is transmitted in the input image with the CPX-F8DE-P (digital inputs).</p>

<b>Term/abbreviation</b>	<b>Meaning</b>
Safe state	Status in which a system works with secured process values or safe substitute values to prevent potentially dangerous movements or other types of hazard.
Safety chain	All elements of a safety device.
Safety circuit	Total of all signals processed for a safety function and their sources. Example: 2 door switches including wiring and 2 related discrepancy-monitored inputs, their monitoring and the related safety engineering actuators.
Safety classification	An indicator of Functional Safety comprising → Performance level, → Category and → Safety integrity level.
Safety control unit	Programmable logic controller with special elements for processing safe input information into safe output information.
Safety integrity	Effectiveness of safety functions in a safety-related system under requirement-based parameters governing the use of a product (e.g. voltage, temperature, industrial environments, PELV).
Safety integrity level	Safety integrity level (SIL) for safety-related systems in acc. with EN 61508. There are 4 levels (SIL 1 to SIL 4). SIL 1 is the lowest level and SIL 4 is the highest level of safety integrity. The higher the level, the less probable it is that the system will fail in a dangerous manner.
Safety program	Safety-related user program in the F-Host.
Safety pilot circuit	Safety circuit including safety-related control by the controller.
Safety-related communication	Exchange of safety-related messages between F-Host and F-Device (e.g. via → PROFIsafe).
Sensor	In the context of a safety engineering evaluation, a sensor is a device that converts the safety engineering status of a system into digital switch signals, e.g. emergency stop switch, light curtain, door switch.
Short circuit	Connection of switching points with normally different electrical potentials, e.g. of 0 V and 24 V of one voltage source.
SIL	Safety Integrity Level.
SIL CL	SIL Claim Limit: claim limit for subsystems in a safety-related electrical control system.

<b>Term/abbreviation</b>	<b>Meaning</b>
Test pulse	Fast switch impulses (e.g. from OSSD sensor) for monitoring of switching capacity and for detection of cross-circuiting → Forced dynamic response. Test impulses are tolerated up to a max. duration of 0.7 ms.
Wire break detection	Function that, under certain conditions, detects and reports a wire break.

Tab. 0/9: Product-specific Terms and Abbreviations

## Contents and general safety instructions



# System overview CPX-F8DE-P

## Chapter 1

## Contents

<b>1.</b>	<b>System overview CPX-F8DE-P</b>	<b>1-1</b>
1.1	CPX terminal with CPX-F8DE-P	1-3
1.1.1	Design of the input module	1-3
1.1.2	Components	1-4
1.1.3	Supported CPX product versions	1-9
1.1.4	Required bus topology (control chain)	1-11
1.2	PROFIsafe	1-12
1.2.1	PROFIsafe safety profile	1-12
1.2.2	Process image (I/O image)	1-13
1.2.3	Bit pattern of the output and input data (F usage data)	1-14
1.2.4	Channel-wise passivation	1-16
1.3	Mode of operation of the input module	1-18
1.3.1	Safe system status	1-19
1.3.2	Overview of applications	1-19
1.3.3	Details of the function modes	1-21
1.3.4	Use of clock signals	1-40
1.3.5	Channel bundling	1-41
1.4	Application examples	1-42
1.4.1	Control desk	1-42
1.4.2	Rotary indexing table	1-44
1.4.3	Limit position switch	1-46
1.4.4	Light curtain	1-47
1.4.5	Acknowledge button with request	1-48
1.4.6	2 two-wire sensors	1-49
1.4.7	2 safety doors on one channel pair	1-49
1.4.8	Safety door with two N/O switches	1-50

## 1. System overview CPX-F8DE-P

### 1.1 CPX terminal with CPX-F8DE-P

#### 1.1.1 Design of the input module

- 1 Manifold block  
CPX-M-AB-4-  
M12X2-5POL(-T)
- 2 Manifold block  
CPX-AB-8-KL-4POL
- 3 Manifold block  
CPX-AB-ID-P with  
internal 8x DIL  
switch for coding
- 4 Electronics  
module  
CPX-F8DE-P
- 5 10x DIL switch for  
PROFIsafe  
address
- 6 Interlinking block  
with contact rails,  
e.g. CPX-M-GE-EV
- 7 Product labelling
- 8 Electrical plug  
connector
- 9 LEDs on the input  
module
- 10 Retaining screws

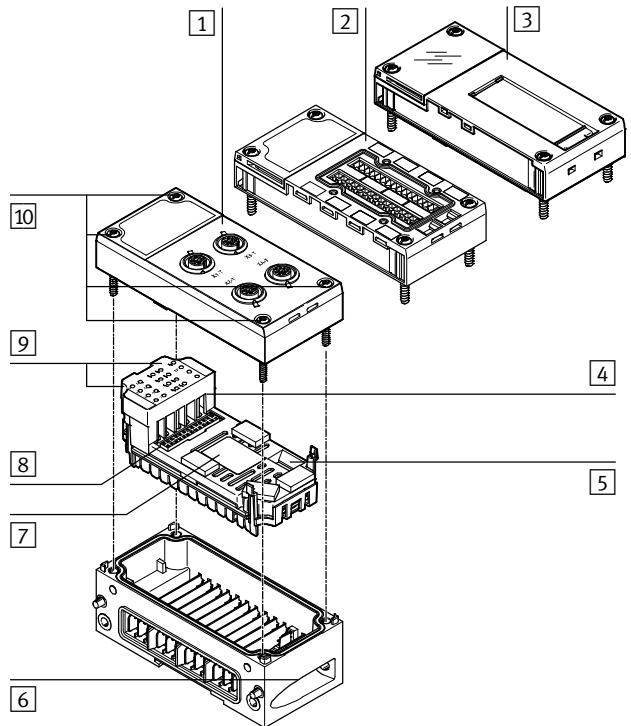

Fig. 1/1: Design of the input module CPX-F8DE-P

- Use only metal interlinking blocks.

## 1. System overview CPX-F8DE-P

### 1.1.2 Components

#### Manifold blocks

The manifold block provides the input module with connection technology. The CPX-F8DE-P may only be operated with the following manifold blocks:

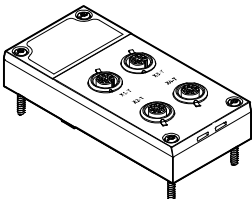
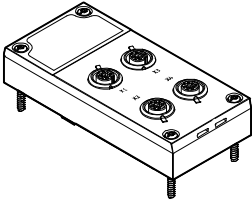
Manifold block	Description
 <p>CPX-M-AB-4-M12X2-5POL-T</p>	<p>M12 metal connection technology</p> <ul style="list-style-type: none"><li>– 4 M12 sockets with metal thread, 5-pin</li><li>– For the use of sensors with static or clocked 24 V DC power supply</li><li>– For the use of sensors with a current consumption up to 0.7 A</li><li>– Degree of protection IP65 when using cover caps ISK-M12 for unused connections</li></ul>
 <p>CPX-M-AB-4-M12X2-5POL</p>	<p>M12 metal connection technology</p> <ul style="list-style-type: none"><li>– 4 M12 sockets with metal thread, 5-pin</li><li>– For the use of sensors with static 24 V DC power supply only</li><li>– For the use of electronic sensors with current consumption up to 2 A</li><li>– Degree of protection IP65 when using cover caps ISK-M12 for unused connections</li></ul>

## 1. System overview CPX-F8DE-P

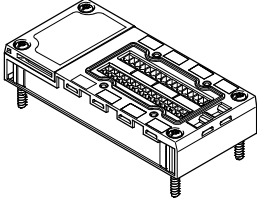
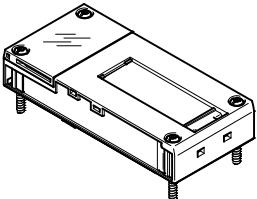
Manifold block	Description
<p data-bbox="140 359 308 379">CPX-AB-8-KL-4POL</p> 	<p data-bbox="426 359 756 379">Terminal strip connection technology</p> <ul data-bbox="426 383 1008 630" style="list-style-type: none"><li>- 2 terminal strips, 16-pin (4 x 4-pin)</li><li>- All cores can be placed individually in a spring-loaded terminal</li><li>- Connections combined in groups of 4 with one functional earth connection for each group</li><li>- For the use of sensors with static or clocked 24 V DC power supply</li><li>- For the use of sensors with mechanical switch contacts and electronic sensors with a current consumption up to 0.7 A</li><li>- Degree of protection IP20</li><li>- Degree of protection IP65 with use of covering AK-8KL</li></ul>
<p data-bbox="140 665 252 686">CPX-AB-ID-P</p> 	<p data-bbox="426 665 840 686">Manifold block without connection technology</p> <ul data-bbox="426 689 593 710" style="list-style-type: none"><li>- Coded identifier</li></ul>

Tab. 1/1: Permissible manifold blocks

Information on electrical connection and display elements  
→ Chapter 2.2.

## 1. System overview CPX-F8DE-P

### Electronics module

The electronics module contains the electronic components of the input module. It is connected to the interlinking block and the manifold block with electrical plug connectors.

The PROFIsafe address can be set directly at the electronics module with a DIL switch → Chapter 2.4.

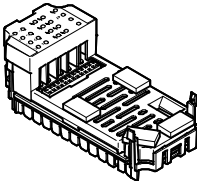
Electronics module	Description
<p data-bbox="87 608 194 630">CPX-F8DE-P</p> 	<ul data-bbox="367 608 947 756" style="list-style-type: none"><li>- 8 digital input channels</li><li>- Evaluation of the digital input channels with safety-related PLC via PROFIsafe</li><li>- Status and error display per input channel</li><li>- Module error display</li><li>- Short-circuit protection.</li></ul>

Tab. 1/2: Electronics module

### Interlinking blocks

An interlinking block establishes the mechanical and electrical connection to the CPX terminal.



#### Note

Malfunctions possible due to absent shielding.

- Use only metal interlinking blocks.

## 1. System overview CPX-F8DE-P

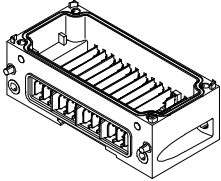
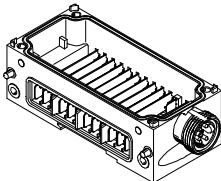
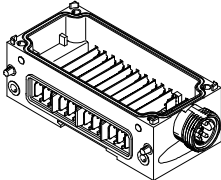
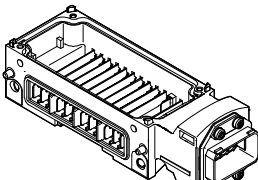
Interlinking block	Description
<p data-bbox="140 355 260 376">CPX-M-GE-EV</p> 	<p data-bbox="427 355 630 376">without system supply</p>
<p data-bbox="140 592 372 612">CPX-M-GE-EV-S-7/8-5POL</p> 	<p data-bbox="427 592 826 612">with system supply, connection: 7/8" (5-pin)</p>
<p data-bbox="140 831 384 852">CPX-M-GE-EV-S-7/8-CIP-4P</p> 	<p data-bbox="427 831 826 852">with system supply, connection: 7/8" (4-pin)</p>
<p data-bbox="140 1070 361 1091">CPX-M-GE-EV-S-PP-5POL</p> 	<p data-bbox="427 1070 865 1091">with system supply, connection: push-pull (5-pin)</p>

## 1. System overview CPX-F8DE-P

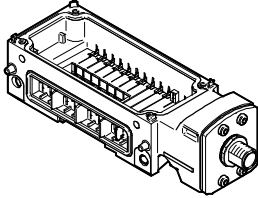
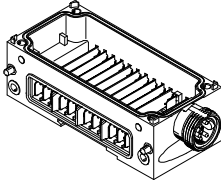
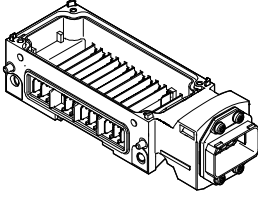
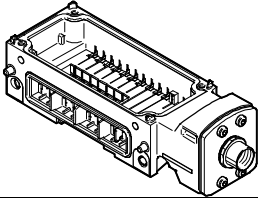
Interlinking block	Description
<p data-bbox="79 357 320 379">CPX-M-GE-EV-S-M12-5POL</p> 	<p data-bbox="367 357 760 379">with system supply, connection: M12 (5-pin)</p>
<p data-bbox="79 608 309 630">CPX-M-GE-EV-Z-7/8-5POL</p> 	<p data-bbox="367 608 790 630">with additional supply, connection: 7/8" (5-pin)</p>
<p data-bbox="79 844 301 866">CPX-M-GE-EV-Z-PP-5POL</p> 	<p data-bbox="367 844 832 866">with additional supply, connection: push-pull (5-pin)</p>
<p data-bbox="79 1090 325 1112">CPX-M-GE-EV-W-M12-5POL</p> 	<p data-bbox="367 1090 801 1112">with voltage forwarding, connection: M12 (5-pin)</p>

Tab. 1/3: Permissible interlinking blocks



## 1. System overview CPX-F8DE-P

### 1.1.3 Supported CPX product versions

A PROFIBUS or PROFINET-compliant bus node is required for control of the input module CPX-F8DE-P. The CPX terminal must be equipped with one of the following bus nodes  
→ Product labelling.

<b>Bus node</b>	<b>From revision</b>	<b>Network protocol</b>
CPX-FB13	30	PROFIBUS
CPX-FB33	21	PROFINET IO
CPX-M-FB34	21	PROFINET IO
CPX-M-FB35	21	PROFINET IO
CPX-FB43	50	PROFINET IO
CPX-M-FB44	50	PROFINET IO
CPX-M-FB45	50	PROFINET IO

Tab. 1/4: Bus node for control of the CPX-F8DE-P

The following product versions of the CPX terminal support operation of the input module CPX-F8DE-P in conjunction with the listed bus nodes:

<b>Product version</b>	<b>Description</b>
Electrical terminal	Modular electrical terminal CPX (without pneumatic modules)
MPA-S-FB-VI	Valve terminal MPA-S with modular electrical peripheral equipment CPX
VTSA-FB-VI VTSA-FB-NPT-VI	Valve terminal VTSA with modular electrical peripheral equipment CPX
VTSA-F-FB-VI VTSA-F-FB-NPT-VI	Valve terminal VTSA-F with modular electrical peripheral equipment CPX

Tab. 1/5: Supported product versions in combination with the above bus nodes

## 1. System overview CPX-F8DE-P

<b>Product versions</b>	
<b>Valve terminal</b>	<b>Valve types</b>
MPA-S-FB-VI	MPA1, MPA2 on VMPA...FB-EMG-...
VTSA-FB-VI	All up to width of 52 mm
VTSA-F-FB-VI	All up to width of 52 mm

Tab. 1/6: Supported product versions of the CPX terminal

## 1. System overview CPX-F8DE-P

### 1.1.4 Required bus topology (control chain)

Hardware and software components are required to set up safety-related systems. For example, a safety controller (F-Host) with corresponding planning and programming tools is required.

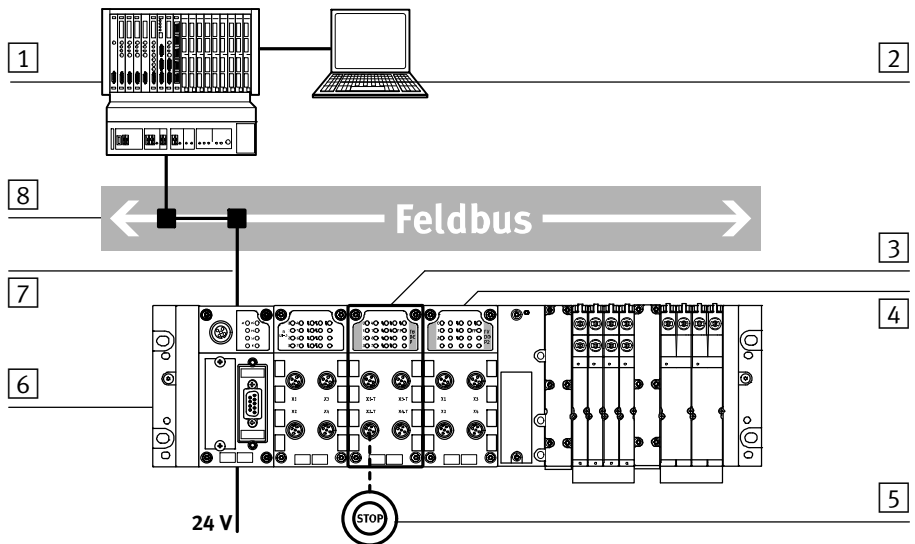

- |   |  |
|---|--|
| 1 Safety controller (F-Host)                        | 5 Emergency stop button (example)                        |
| 2 Safety Configuration Tool (for safety controller) | 6 CPX terminal with bus node for PROFIBUS or PROFINET IO |
| 3 Input module CPX-F8DE-P                           | 7 Embedded PROFIsafe data (black channel)                |
| 4 Output module CPX-FVDA-P2 (example)               | 8 PROFIBUS or PROFINET IO                                |

Fig. 1/2: Communication between safety controller and safety modules via PROFIsafe

## 1. System overview CPX-F8DE-P

### 1.2 PROFIsafe

Data are exchanged between the input module and the safety controller with the safety-related PROFIsafe bus profile from PROFIBUS or PROFINET IO.

#### 1.2.1 PROFIsafe safety profile

The PROFIsafe telegrams are embedded in standard telegrams and are directed via the so-called black channel from the safety controller to the input module. The black channel extends from the field bus connection on the safety controller via the bus node to the input module CPX-F8DE-P → Fig. 1/2. The PROFIsafe telegrams are processed there by the input module.

In addition to process data, the PROFIsafe telegrams also transmit safety information. Therefore, the CPX-F8DE-P assigns 6 bytes in the input image and 7 bytes in the output image of the CPX terminal → Fig. 1/3; 3, 4, 5.

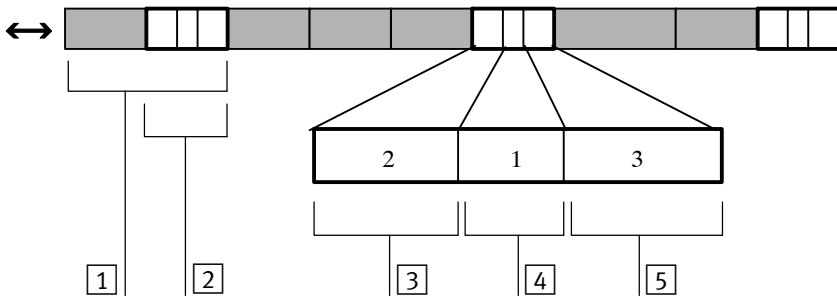

- |   |   |
|---|---|
| <b>1</b> Standard telegram with embedded PROFIsafe data | <b>3</b> 2 bytes for F usage data from the module<br>3 bytes for F usage data to the module |
| <b>2</b> Embedded PROFIsafe telegram                    | <b>4</b> 1 byte status or control byte  |
|   | <b>5</b> 3 bytes CRC signature (CRC2)   |

Fig. 1/3: Telegram structure of the input module CPX-F8DE-P

## 1. System overview CPX-F8DE-P

Data are transmitted on the same physical basis as the transfer of process data to a standard module. There is a distinction between the kind of data and the interpretation of that data by the F-Device (PROFIsafe slave).

The following applies for PROFIsafe communication in connection with the input module CPX-F8DE-P:

- the module supports the PROFIsafe V2.4 bus profile in the V2 mode
- parameterisation to V1 mode is rejected.

### 1.2.2 Process image (I/O image)

The safety features of PROFIsafe mean that the input module CPX-F8DE-occupies 7 bytes for outputs and 6 bytes for inputs in the process image of the CPX terminal.

Outputs consist of:

- 3 bytes of output data (F usage data, ➔ Tab. 1/7)
- 1 control byte (for PROFIsafe communication)
- 3 bytes CRC (for PROFIsafe communication).

Inputs consist of:

- 2 bytes input data (F usage data, ➔ Tab. 1/8)
- 1 status byte (for PROFIsafe communication)
- 3 bytes CRC (for PROFIsafe communication).



Function modes are set via the output data from the input module.

## 1. System overview CPX-F8DE-P

### 1.2.3 Bit pattern of the output and input data (F usage data)

#### Output data

Byte 0 serves to activate channel-based passivation and to acknowledge channel errors → Chapter 1.2.4.

Bytes 1 and 2 serve to select the function modes for all channel pairs and are set as a 16-bit wide word by the F-host.

Bit pattern of the output data									
Byte	Bit 7	Bit 6	Bit 5	Bit 4	Bit 3	Bit 2	Bit 1	Bit 0	
0	0	0	0	0	0	0	1/0	1/0	
	Operating mode: 1 = channel-based passivation 0 = module-based passivation								
	1 = acknowledgment of a channel error								
1	8	4	2	1	8	4	2	1	
	Function mode for channel pair 7/6				Function mode for channel pair 5/4				
2	8	4	2	1	8	4	2	1	
	Function mode for channel pair 3/2				Function mode for channel pair 1/0				

Tab. 1/7: Bit pattern for output data (F usage data, bytes 0, 1 and 2)

- Ensure that the data in the output image contain a valid module configuration for your safety application.

## 1. System overview CPX-F8DE-P

### Input data

The input module reflects the logical actual values back to the F-Host as an input image via byte 0 → Tab. 1/8.

Byte 1 receives qualification information corresponding to the input module.

Bit pattern of the input data: byte 0 and byte 1								
Byte	Bit 7	Bit 6	Bit 5	Bit 4	Bit 3	Bit 2	Bit 1	Bit 0
0	E7	E5	E3	E1	E6	E4	E2	E0
	Input image							
1	Q7	Q5	Q3	Q1	Q6	Q4	Q2	Q0
	Qualification bits Qx = 1: signal Ex is valid Qx = 0: signal Ex is invalid, incorrect input function due to function mode/ channel error/module error							

Tab. 1/8: Bit pattern of input data (F usage data, byte 0 and byte 1)

Byte 0 contains the logical status of the inputs in accordance with function mode. The input bits are only set to 1 if the related qualification bit is also set to 1.

Byte 1 contains the qualification bits. The qualification bits only change to 1 if there is no channel error, and if the channel was depassivised after a previous error in the channel.

Byte	Bit 7	Bit 6	Bit 5	Bit 4	Bit 3	Bit 2	Bit 1	Bit 0
0	0	0	E3	E1	0	0	E2	E0
1	1	1	1	1	1	1	1	1

Tab. 1/9: Input image; example for channel pairs E0/E1 and E2/E3

## 1.2.4 Channel-wise passivation

“Channel-based passivation” can be switched on or off via bit 1 of byte 0 for output data (PAA) → Tab. 1/7.

### Channel-based passivation disabled

While this function is disabled (0 = Off), in accordance with PROFIsafe specification and even if there is only one channel error, the input module switches all information on the input image into a safe status (= module-based passivation).

- All inputs = 0
- All qualification bits = 0



Passivation in the event of an error is based on PROFIsafe specification.

For troubleshooting:

- Note diagnostic messages from module in the F-Host.

### Channel-based passivation enabled

If this function is enabled (1 = on), if a channel error occurs, the input module switches the input information of the affected channel pair to 0, depending on the function mode.

The input information of unaffected channel pairs does not change and the input module remains integrated.

The input module indicates via the input image the current channel error status to the control unit:

- All input bits relating to the channel bundle = 0
- All qualification bits relating to the channel bundle = 0



## 1. System overview CPX-F8DE-P

### Acknowledgment sequence

When using the channel-based passivation, acknowledgment is made with the help of the safety program via bit 0 from byte 0 of the output data (PAA) → Tab. 1/7.

The following description of the sequence shows the bits in the input and output image of the input module that are relevant to channel-based passivation.

No.	Sequence	Channel-wise passivation <sup>1)</sup>	Electrical status at input	Status in the input image <sup>2)</sup>	Qualification bit <sup>2)</sup>	Acknowledgment of channel error <sup>1)</sup>
1	Module is not passivated	1 (active)	X	X	1	0
	Channel error occurs					
2	Module has detected the channel error	1 (active)	X	0	0	0
	F-Host detects the channel error in the module					
3	User clears a channel error					
	User acknowledges the channel error (at least 1 F-I/O cycle)	1 (active)	X	0	0	1
4	Channel is no longer passivated	1 (active)	X	X	1	X
<p>The cells highlighted in grey indicate the bits that are relevant for the applicable table row.            1) Bit in output image → Tab. 1/7            2) Bit in input image → Tab. 1/8, byte 1            X: Signal can be 0 or 1</p>						

Tab. 1/10: Sequence description of channel error acknowledgment – example

Automatic acknowledgment is possible by holding the acknowledgment bit permanently at “1”.

If acknowledged while an error is still present, the input image remains in safe mode. In the event of undesired automatic acknowledgment, a safety program must ensure that the safety controller cancels that acknowledgment.



### **Note**

In the event of a restart of the F-Host (Stop → Run) the channel monitoring of the input module CPX-F8DE-P is restarted.

If the cause of the error is still pending, the channel error will be triggered again.

### **1.3 Mode of operation of the input module**

The inputs on the input module are always evaluated by 2 independent internal channel paths. To this end, the input module is equipped with 2 processors that monitor each other continuously and can also monitor the input channels for cross circuit, depending on the selected function modes.

The input module is designed such that the input channels can provide either secure data or no data at all, even if there is an error in the system, e.g. with:

- Overvoltage, undervoltage, overload, short circuit and cross circuit
- PROFIsafe communication failure or malfunction
- Failure or defect of individual safety-determining components of the input module.

## 1. System overview CPX-F8DE-P

### 1.3.1 Safe system status

Whenever an error is diagnosed in the input information for the module, the reaction depends on the selected module operating mode:

- With the “Module-based passivation” operating mode (PAA byte 0, bit 1 = 0) the module passivation is performed in accordance with the PROFIsafe specification.
- For the operating mode “channel-based passivation” (PAA byte 0, bit 1 = 1), the affected channel bits (Ex, Qx) in the input image (PAE byte 0 and 1) are set to logic 0.

Module passivation is based on the PROFIsafe specification in the case of a diagnosed internal module error.

In the case of a massive, stochastic failure of the module hardware, the PROFIsafe timeout occurs as a system reaction.

### 1.3.2 Overview of applications

The input module can be used for the following tasks:

- Connection of various switches and sensors within the safety chain
- Use of multi-channel sensor applications with up to 8 secure inputs, can be grouped and configured with the aid of 11 different function modes
- Use as an input module for a higher-order safety controller. Multiple input modules can be used together to monitor sensors independently.



The following overview constitutes a selection and lists some but not all possible applications.

## 1. System overview CPX-F8DE-P

No.	Application	Architecture	Contact type	Function mode	Max. sensor applications
1	Pushbutton, switch, sensor	1oo1	electronic	1; 2	8
		1oo1 T	mechanical	3	8
		1oo1 D	antivalent	4	8
		1oo2	OSSD	5	4
		1oo2 T	mechanical	6	4
2	Sensor with clock signal input	1oo1 T	OSSD	3	8
3	Emergency stop	1oo1 D	antivalent	4	8
		1oo2	OSSD	5	4
		1oo2 T	mechanical	6	4
4	Light curtain	1oo2	OSSD	5	4
		1oo2 T	mechanical	6	4
5	Two-hand control device type IIIC in accordance with EN 574	1oo2 D	antivalent	7	4
6	Safety door	1oo2 T robust	mechanical	8	4
7	Mode selector switch, rotary indexing table	1 of N	mechanical, electronic, OSSD	9	2
8	Tool detection	Identifier	mechanical, electronic, OSSD	10	1

Tab. 1/11: Possible applications with contact types and appropriate function modes

## 1. System overview CPX-F8DE-P

### 1.3.3 Details of the function modes

The input module CPX-F8DE-P includes various function modes for implementation of safety circuits with recommended sensors. These function modes can be set separately for each channel pair.

Recommended sensors	Function mode									
	1	2	3	4	5	6	7	8	9	10
Sensors with mechanical switch contacts	–	–	◇	●	–	●	●	●	●	●
Sensors with self-monitored electronic outputs	◇	◇	–	–	●	–	–	–	●	●
Electronic three-wire sensors with a ready-state delay of < 23 ms or Electronic two-wire sensors with a ready-state delay of < 2 ms	–	–	◇	–	–	◇	–	◇	–	–
Additionally: – with reverse polarity protection at the positive supply port or – without free-wheeling diode at the sensor output.	–	–	–	●	–	–	–	–	–	–
● Recommended function mode ◇ Can be used with low safety requirements										

Tab. 1/12: Recommended sensors



#### Note

Some function modes may restrict the manifold blocks that can be selected.

- Make sure that the manifold block required for the safety function is used.

## 1. System overview CPX-F8DE-P



### Note

The following applies for all applications of sensors and switches in combination with the corresponding function modes of the input module CPX-F8DE-P:

The achievable safety integrity level, performance level and category of your system are limited by the component of the safety chain with the lowest characteristic value.

- Use only switches and sensors that meet the safety engineering requirements of the application.
- When using well-tried components in accordance with EN 13849-2, Table D.3, calculate the safety classification from the respective manufacturer's specifications.

The specifications of the switches and sensors include information on safety engineering considerations and operating conditions.



### Note

Malfunctions at unused inputs are possible.

- Make sure that function mode 0 is always set for unused channel pairs.



For function modes with clock signals:

- Clock outputs T1, T3, T5 and T7 have the same clock signal.
- Clock outputs T0, T2, T4 and T6 run clock signals different from one another and compared to T1/T3/T5/T7.



### Note

With bit-based programming of the function mode:

- Make sure that the mode switching is implemented within one PROFIsafe cycle. Otherwise there may a short-term switch to a different function mode, which may cause unexpected reactions. Take this into account in your application.



### Function mode 0 – no signal evaluation

When switching on the input module, all channel pairs are preset to this mode. This function mode is used for initial commissioning of wiring and sensors.

Circuit diagram	Channel pair connections			
	T0/24 V	T2/24 V	T4/24 V	T6/24 V
	E1	E3	E5	E7
	0 V			
	E0	E2	E4	E6
	T1/FE	T3/FE	T5/FE	T7/FE

Tab. 1/13: Function mode 0

Both channels always generate a logic 0 as input information and a logic 1 as qualifier in the input image.

The signals of connected sensors are displayed only at the status LEDs.

#### Functional safety

There is **no** safety-oriented evaluation in function mode 0.

### Function mode 1 – 1001 (T0, T2, T4, T6 static on)

Signal evaluation of up to 2 independent single-channel switches/sensors (N/O or N/C) per channel pair. In this function mode, T0, T2, T4 and T6 are at static 24 V DC.

## 1. System overview CPX-F8DE-P

Circuit diagram	Channel pair connections			
	T0/24 V	T2/24 V	T4/24 V	T6/24 V
	E1	E3	E5	E7
	0 V			
	E0	E2	E4	E6
	T1/FE	T3/FE	T5/FE	T7/FE

Tab. 1/14: Function mode 1 – 1oo1

### Functional safety

- PL c, Cat. 1/SIL 1  
**with** switch/sensor tried and tested in accordance with EN 13849-2, Table D.3,  
**and with** wiring protection of the customer application in accordance with EN 13849-2, Table D.4



## 1. System overview CPX-F8DE-P

### Function mode 2 – 1oo1 test (T0, T2, T4, T6 static off)

Signal evaluation of up to 2 independent single-channel switches/sensors (N/O or N/C) per channel pair. In this function mode, T0, T2, T4 and T6 are not connected to voltage.

Circuit diagram	Channel pair connections			
	T0	T2	T4	T6
	E1	E3	E5	E7
	0 V			
	E0	E2	E4	E6
	T1/FE	T3/FE	T5/FE	T7/FE

Tab. 1/15: Function mode 2 – 1oo1 test



Function mode 2 can be used as a test mode when you connect sensors for function mode 1.

A safety control that alternately uses the function mode 1 and 2 can in this way generate user-specific test signals and evaluate whether a zero crossover has taken place.

Software-generated test signals only work with the following manifold blocks:

- CPX-M-AB-4-M12X2-5POL-T
- CPX-AB-8-KL-4POL.



#### Note

Safety requests cannot be evaluated by the safety control during the test period.

Function mode 2 can be alternatively used to reset sensors with self-monitored electronic outputs.

**Functional safety**

- PL c, Cat. 1/SIL 1  
**with** switch/sensor tried and tested in accordance with EN 13849-2, Table D.3,  
**and with** wiring protection of the customer application in accordance with EN 13849-2, Table D.4

Function mode 3 – 1oo1 T (with clock signal monitoring)

Signal evaluation of up to 2 independent single-channel switches/sensors per channel pair with individually clocked sensor power via T0, T2, T4, T6 and with common clock signal via T1, T3, T5, T7.



This function mode detects short circuits and cross circuits in the sensor wiring.

**Example A**

2 single-channel switches/sensors (N/O or N/C)

Circuit diagram	Channel pair connections			
	T0	T2	T4	T6
	E1	E3	E5	E7
	0 V			
	E0	E2	E4	E6
	T1	T3	T5	T7

Tab. 1/16: Function mode 3 – 1oo1 T (example A)



**Note**

Safety evaluation only with the following manifold blocks:

- CPX-M-AB-4-M12X2-5POL-T
- CPX-AB-8-KL-4POL.

**Example B**

2 single-channel safety sensors with test input

Circuit diagram	Channel pair connections			
	24 V	24 V	24 V	24 V
	T0	T2	T4	T6
	E1	E3	E5	E7
	0 V			
	E0	E2	E4	E6
	T1	T3	T5	T7

Tab. 1/17: Function mode 3 – 1oo1 T (example B)



**Note**

Safety-related evaluation only with the following manifold block:

- CPX-AB-8-KL-4POL.



8 single-channel safety sensors can be connected at this manifold block.

**Functional safety for both examples**

- PL c, Cat. 1/SIL 1  
**with** switch/sensor tried and tested in accordance with EN 13849-2, Table D.3
- **up to** PL c, Cat. 3/SIL 2  
**with** certified switch/sensor of suitable safety classification  
**and with** wiring protection of customer application in accordance with EN 13849-2, Table D.4,  
**and with** testing of the safety application once a year

## 1. System overview CPX-F8DE-P

- **up to** PL e, Cat. 3/SIL 3  
**with** certified sensor of the appropriate safety classification  
**and with** wiring monitoring by the connected sensor (example B).

### Function mode 4 – 1oo1 D (antivalent)

Signal evaluation of up to two independent dual-channel switches/sensors (internally antivalent, N/O or N/C) or up to four operationally tested switches per channel pair. The clock signals at E1, E3, E5 and E7 are wired as a mirror image of E0, E2, E4, E6.

Circuit diagrams	Channel pair connections			
	T0	T2	T4	T6
	E1	E3	E5	E7
	0 V			
	E0	E2	E4	E6
	T1	T3	T5	T7
	T0	T2	T4	T6
	E1	E3	E5	E7
	0 V			
	E0	E2	E4	E6
	T1	T3	T5	T7

Tab. 1/18: Function mode 4 – 1oo1 D

This function mode tests the switch function and wiring of the sensors.

- Use only sensors with antivalent outputs in which the one contact opens before the other contact closes.



## 1. System overview CPX-F8DE-P

- Ensure that the N/O and/or N/C switches of sensors are connected with the appropriate clock signal connections for the channel pair → Circuit diagram.
- Note that before every actuation a zero crossover is required (normally closed contact of the N/C switch closed).



### Note

Safety evaluation only with the following manifold blocks:

- CPX-M-AB-4-M12X2-5POL-T
- CPX-AB-8-KL-4POL.

### Functional safety

- PL e, Cat. 3/SIL 3  
**with** 2 independent switches/sensors tried and tested in accordance with EN 13849-2, Table D.3, the switches/sensors must be implemented as independent systems in the customer application
- **up to** PL e, Cat. 3/SIL 3  
**with** certified switches/sensors of an appropriate safety classification.

## 1. System overview CPX-F8DE-P

### Function mode 5 – 1oo2 (equivalent)

Signal evaluation of a sensor (typically OSSD), which switches both signals of the channel pair simultaneously.

Short-circuit and cross-circuit monitoring can be implemented via the sensor.

#### Example A

A two-channel sensor (internally equivalent) per channel pair with uniformly unlocked sensor power. In this function mode, T0, T2, T4 and T6 are at static 24 V DC.

Circuit diagram	Channel pair connections			
	T0/24 V	T2/24 V	T4/24 V	T6/24 V
	E1	E3	E5	E7
	0 V			
	E0	E2	E4	E6
	T1/FE	T3/FE	T5/FE	T7/FE

Tab. 1/19: Function mode 5 – 1oo2 (example A)

#### Example B

OSSD sensor

Circuit diagram	Channel pair connections			
	24 V	24 V	24 V	24 V
	E1	E3	E5	E7
	0 V			
	E0	E2	E4	E6
	T1/FE	T3/FE	T5/FE	T7/FE
	FE contact of the sensor via the M12 plug screw connection on the module			

Tab. 1/20: Function mode 5 – 1oo2 (example B)



### Note

Malfunction during use of OSSD sensors on the manifold block CPX-M-AB-4-M12X2-5POL-T.

The connection of an FE contact to Pin 5 on an M12 socket causes a short circuit. This would result in a malfunctioning of signals T1, T3, T5 and T7.

The input module reports module error 2: "Short circuit".

- Connect the FE contact of a sensor only to the M12 plug screw connection of the module.

### Functional safety

- **up to** PL d, Cat. 2/SIL 2  
**with** certified switch/sensor of an appropriate safety classification  
**and with** automatic testing of the safety function by the machine within 24 h
- **up to** PL d, Cat. 2/SIL 3  
**with** certified switch/sensor of an appropriate safety classification  
**and with** wiring protection of the customer application in accordance with EN 13849-2, Table D.4,  
**and with** automatic testing of the safety function by the machine within 24 h
- **up to** PL e, Cat. 4/SIL 3  
**with** certified sensor (OSSD) of an appropriate safety classification  
**and with** wiring monitoring by the connected sensor (example B).

### Function mode 6 – 1oo2 T (equivalent, with clock signal monitoring)

Signal evaluation of a dual-channel switch/sensor (internally equivalent) per channel pair with individually clocked power supply.

Circuit diagram	Channel pair connections			
	T0	T2	T4	T6
	E1	E3	E5	E7
	0 V			
	E0	E2	E4	E6
	T1	T3	T5	T7

Tab. 1/21: Function mode 6 – 1oo2T



This function mode detects short circuits and cross circuits in the sensor wiring.

This function mode is particularly suitable for applications that expect fast reactions (e.g. emergency stop, certified switches/sensors).



#### Note

Safety evaluation only with the following manifold blocks:

- CPX-M-AB-4-M12X2-5POL-T
- CPX-AB-8-KL-4POL.

#### Functional safety

- **up to** PL e, Cat. 3/SIL 2  
**with** certified switches/sensors of an appropriate safety classification



## 1. System overview CPX-F8DE-P

- **up to** PL e, Cat. 4/SIL 3  
**with** certified switch/sensor of an appropriate safety classification  
**and with** automatic testing of the safety function by the machine within 24 h
- **up to** PL e, Cat. 4/SIL 3  
**with** certified switch/sensor of an appropriate safety classification  
**and with** wiring protection of the customer application in accordance with EN 13849-2, Table D.4.

### Function mode 7 – 1oo2 D (two-hand control device type IIIC in accordance with EN 574)

Signal evaluation of up to 2 dependent two-channel switches/sensors (internally antivalent, N/O/N/C) per channel pair, with time monitoring of signal change. The clock signals at E1, E3, E5 and E7 are wired as a mirror image of E0, E2, E4, E6.

Pressing both pushbuttons within 500 ms generates a logic 1 in the input image of the channel pair.

Note that a zero crossing is required before every actuation (both N/C standby contacts closed).

Circuit diagram	Channel pair connections			
	T0	T2	T4	T6
	E1	E3	E5	E7
	0 V			
	E0	E2	E4	E6
	T1	T3	T5	T7

Tab. 1/22: Function mode 7 – 1oo2 D

## 1. System overview CPX-F8DE-P

- Use only sensors with antivalent outputs in which the one contact opens before the other contact closes.
- Ensure that the N/O and/or N/C switches of sensors are connected with the appropriate clock signal connections for the channel pair → Circuit diagram.



### Note

Safety evaluation only with the following manifold blocks:

- CPX-M-AB-4-M12X2-5POL-T
- CPX-AB-8-KL-4POL.

### Functional safety

- PL e, Cat. 4/SIL 3  
with 2 switches/sensors, wiring and safety function in accordance with EN 574 Type IIIC.

Function mode 8 – 1oo2 T (equivalent, with clock signal monitoring, robust)

Signal evaluation of mechanical contacts on a two-channel switch/sensor (internally equivalent) or of 2 independent, tried and tested switches.

Circuit diagram	Channel pair connections			
	T0	T2	T4	T6
	E1	E3	E5	E7
	0 V			
	E0	E2	E4	E6
	T1	T3	T5	T7

Tab. 1/23: Function mode 8 – 1oo2T (robust)



This function mode corresponds to function mode 6, but due to an extended evaluation time it is not affected by bouncing contacts.

The function mode is therefore unsuitable for applications that expect fast reactions (e.g. light curtains).

- Note the extended reaction time.
- Only use this function mode for a maximum request rate of 1 per 60 seconds.



### Note

Safety evaluation only with the following manifold blocks:

- CPX-M-AB-4-M12X2-5POL-T
- CPX-AB-8-KL-4POL.

### Functional safety

- **up to** PL e, Cat. 3/SIL 2  
**with** certified switch/sensor of an appropriate safety classification or 2 independent tested switches in accordance with EN 13849-2, Table D.3
- **up to** PL e, Cat. 4/SIL 3  
**with** certified switch/sensor of an appropriate safety classification or 2 independent tested switches in accordance with EN 13849-2, Table D.3,  
**and with** automatic testing of the safety function by the machine within 24 h
- **up to** PL e, Cat. 4/SIL 3  
**with** certified switch/sensor of an appropriate safety classification or 2 independent tested switches in accordance with EN 13849-2, Table D.3,  
**and with** wiring protection in accordance with EN 13849-2, Table D.4.

### Function mode 9 – 1 of N (one from N)

Evaluation of one of max. 8 signals with monitoring of signal change over time, e.g. mode selector switch. The input image is switched 100 ms after actuation.

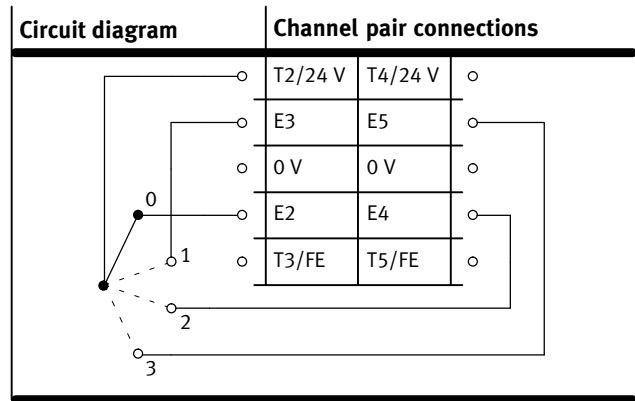

Tab. 1/24: Function mode 9 – 1 of N (one from N)

This function mode serves to evaluate a mode selector switch or a rotary indexing table.

- Use only consecutive channel pairs for channel bundling.
- Activate this function mode for all channel pairs in use.  
Variants: 1 of 2, 1 of 4, 1 of 6 or 1 of 8.

The circuit diagram (➔ Tab. 1/24) shows as an example variant “1 of 4”. The directly consecutive channel pairs E2/E3 and E4/E5 are used, both of which must be configured to function mode 9. The power supply can be optionally switched from T2 or 24 V to one of the inputs E2, E3, E4, E5.

Required for this example: channel pairs E0/E1 and E6/E7 are **not** configured to function mode 9.



### Functional safety

- PL c, Cat. 1/SIL 2  
**with** tested switches/sensors in accordance with EN 13849-2, Table D.3
- **up to** PL e, cat. 3 / SIL 3  
**with** certified switches/sensors of an appropriate safety classification.

### Multiple channel pairs in function mode 9



#### Note

When evaluating more than two signals in a circuit:

- Use directly consecutive channel pairs.

When configuring two independent “1 of N” circuits on one input module:

- Ensure that the channel pairs used for the different circuits are **not** directly consecutive to one another.

All permitted configurations for setting function mode 9 on several channel pairs are listed in the next section.

Channel pair	E0 E1	E2 E3	E4 E5	E6 E7
“1 of 4” circuits	Mode 9	Mode 9		
		Mode 9	Mode 9	
			Mode 9	Mode 9
“1 of 4” and “1 of 2” circuits	Mode 9		Mode 9	Mode 9
	Mode 9	Mode 9		Mode 9
“1 of 6” circuits	Mode 9	Mode 9	Mode 9	
		Mode 9	Mode 9	Mode 9
“1 of 8” circuits	Mode 9	Mode 9	Mode 9	Mode 9
Two independent “1 of 2” circuits	Mode 9		Mode 9	
		Mode 9		Mode 9
	Mode 9			Mode 9

Tab. 1/25: Function mode 9 for up to 2 circuits

- Set the remaining channel pairs as desired – but not to function mode 9.

## Function mode 10 – coded identifier

Evaluation of a coded identifier by DIL switch in manifold block CPX-AB-ID-P.



Prerequisite for use of the coded identifier:

**All** channel pairs are set to function mode 10 via the output image.

8-way DIL switch	Switch	Value	Input
	8	Parity bit	E7
	7	64	E5
	6	32	E3
	5	16	E1
	4	8	E6
	3	4	E4
	2	2	E2
	1	1	E0

Tab. 1/26: Function mode 10 – coded identifier

### Setting coded identifier

1. Set the desired identifier with switches 1 to 7.  
Use only values 1 to 126.
2. If you have an odd number of switches 1 to 7 set to ON:  
also set parity bit (switch 8) to ON.

### Input image

A 0 is always output in the input image instead of the parity bit so the set identifier in the safety control can always be used directly.

## 1. System overview CPX-F8DE-P

### **Functional safety**

- PL e, Cat. 3/SIL 3  
**with** certified switch/sensor of an appropriate safety classification or independent tested switches in accordance with EN 13849-2 Table D.3  
**and with** protection of the application against simple manipulation.

Manifold block CPX-AB-ID-P meets these requirements for functional safety without any supplementary measures.

### 1.3.4 Use of clock signals

Clock signals are used to monitor the wiring on the input channels of the input module.

Specific clock signals are made available for the relevant input channel via T0, T2, T4 and T6:

- to detect cross circuits between inputs and clock signal connections for function modes with clock signals or diagnostics
- to detect short circuits between the inputs/clock signal connections and sensor wiring.



For function modes with clock signals:

- Clock outputs T1, T3, T5 and T7 have the same clock signal.
- Clock outputs T0, T2, T4 and T6 run clock signals different from one another and compared to T1/T3/T5/T7.



#### **Note**

Malfunction during use of OSSD sensors on the manifold block CPX-M-AB-4-M12X2-5POL-T.

The connection of an FE contact to Pin 5 on an M12 socket causes a short circuit. This would result in a malfunctioning of signals T1, T3, T5 and T7.

The input module reports module error 02: "Short circuit 0 V at clock signal output T1357".

- Connect the FE contact of a sensor only to the M12 plug screw connection of the module.



## 1. System overview CPX-F8DE-P

### 1.3.5 Channel bundling

Depending on the function mode in use, 2, 4, 6 or 8 channels can be grouped together to form a channel bundle.

The input and qualification bits behave as follows within a channel bundle:

Status of the inputs	Input bits	Qualification bits of the channel bundle
no error	0 or 1 (depending on the function mode and input signal)	1
error	0	0

Tab. 1/27: Behaviour of input data with channel bundles



If channel-wise passivation is not enabled, all input data bits are set to 0 if an error is detected.

## 1.4 Application examples

The creation of a safety function involves secure evaluation of connected sensors. The following application examples in conjunction with 11 configurable function modes (→ Chapter 1.3.3) show you the different potential options for the intended use of the CPX-F8DE-P.

### 1.4.1 Control desk

This application example shows the possible utilisation of all channel pairs on an input module.

For a typical control desk the following sensors can be evaluated in a safety-related manner:

- two-hand control device for starting a function
- emergency stop switch for incidents
- mode selector switch with 4 positions.

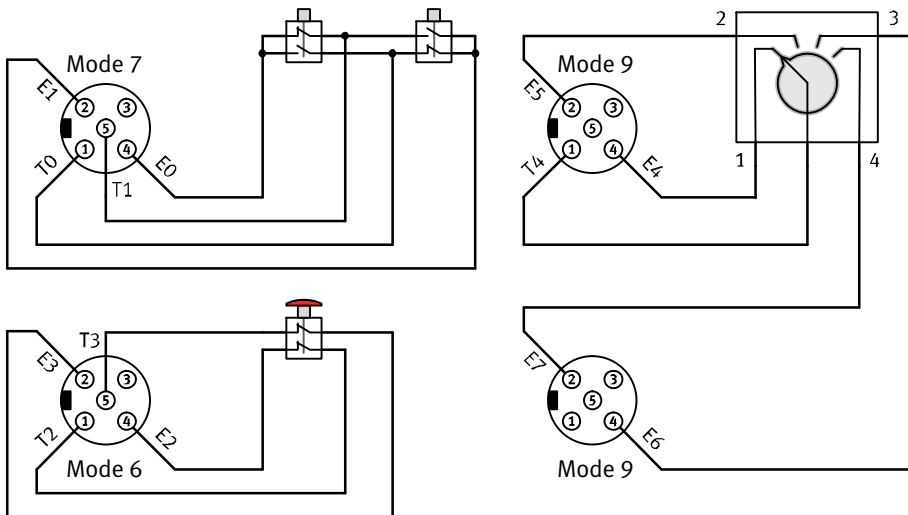

Fig. 1/4: Maximum configuration

## 1. System overview CPX-F8DE-P

Fig. 1/4 shows the circuitry of channel pairs with permitted sensors → Tab. 1/12. This involves the channel pairs being set with the following function modes:

Channel pair	Mode	Comments
E0/E1	7	Evaluation of the two-hand control device
E2/E3	6	Evaluation of the emergency stop button
E4/E5	9	Evaluation of a mode selector switch
E6/E7	9	



### Note

The safety-related evaluation in this example is only possible with the following manifold blocks:

- CPX-M-AB-4-M12X2-5POL-T
- CPX-AB-8-KL-4POL.

## 1. System overview CPX-F8DE-P

### 1.4.2 Rotary indexing table

This application example shows the possible use of 2 channel pairs for 4 positions of a rotary indexing table. It involves the use of 4 N/O contacts that alternately signal the rotational position of the rotary indexing table.

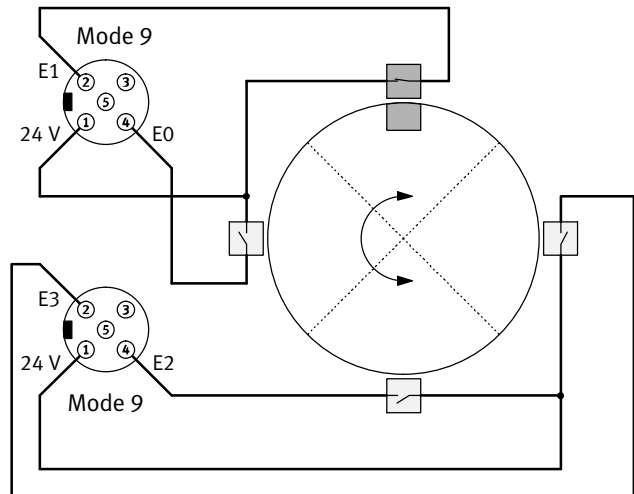

Fig. 1/5: Rotary indexing table with 4 rotational positions

The other channel pairs on the input module can be used to evaluate other sensors on a loading and an unloading station.

When connecting the sensors (e.g. SMT-8M-A) it is advisable to use pre-assembled Y cables from the NEBU modular cable system → [www.festo.com/catalogue](http://www.festo.com/catalogue).

## 1. System overview CPX-F8DE-P

Fig. 1/5 shows the circuitry of channel pairs with independent sensors. This involves the channel pairs being set with the following function modes:

Channel pair	Mode	Comments
E0/E1	9	Evaluation of 4 positions of the rotary indexing table.
E2/E3	9	



This application example can also be implemented using electronic sensors (2-wire or 3-wire sensors).

## 1.4.3 Limit position switch

In this application example, piston positions are evaluated with 2 two-channel sensors with mechanical contacts (internally antivalent, N/O/N/C) via a channel pair on the input module.

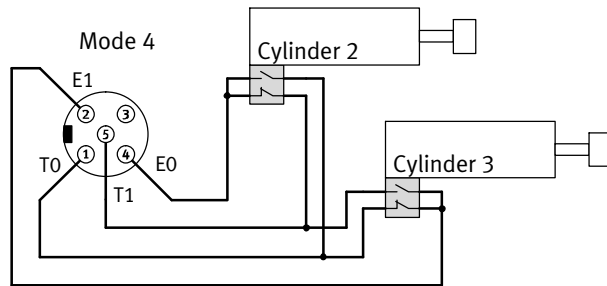

Fig. 1/6: Evaluation of limit position switches



### Note

Malfunctions are possible.

- In this function mode do **not** use electronic sensors with standby diode on a shared sensor output.

Alternatively: electronic 3-wire sensors with reverse polarity protection in positive supply port.



### Note

Safety evaluation only with the following manifold blocks:

- CPX-M-AB-4-M12X2-5POL-T
- CPX-AB-8-KL-4POL.



Antivalence is evaluated in order to diagnose the sensor wiring. Reaching the end position is output as secured logical information in the PAE (input image).

# 1. System overview CPX-F8DE-P

## 1.4.4 Light curtain

This application example shows the connection of transmitter and receiver of a light curtain via a channel pair on the input module.

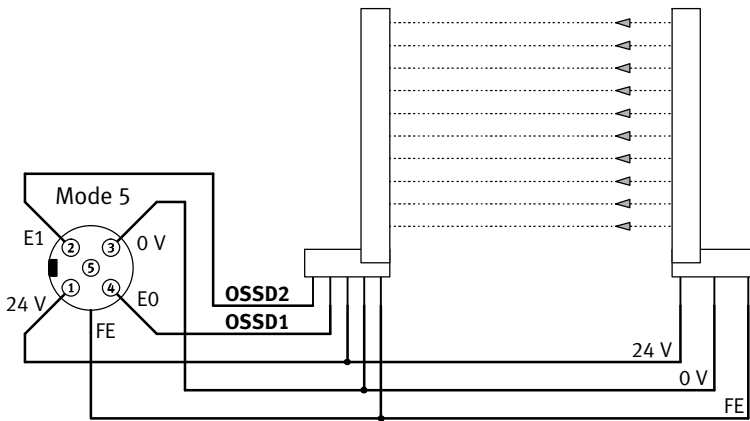

Fig. 1/7: Connection of a light curtain

Channel pair	Mode	Comments
E0/E1	5	Signal evaluation of a sensor (typically OSSD)

The permitted current consumption per connection may vary depending on the manifold block:

- CPX-M-AB-4-M12X2-5POL up to 2 A
- CPX-M-AB-4-M12X2-5POL-T up to 0.7 A.



When wired in a control cabinet, the input module can also be operated with manifold block CPX-AB8-KL-4POL. All signals are available there without any restriction.

## 1.4.5 Acknowledge button with request

This application example shows the circuitry of a button with a light signal. Actuation of this button can only be evaluated while clock signal connection T0 of a channel pair is connected to a 24 V power source. The LED on the button lights at the same time to indicate the possible evaluation of this actuation.

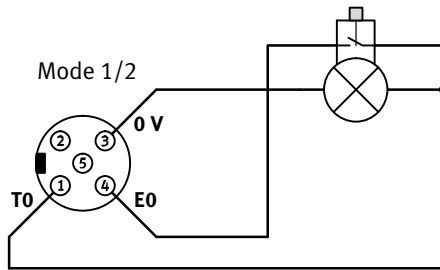

This circuit only functions by switching between function modes 1 and 2 in the safety program.



### Note

The safety-related evaluation in this example is only possible on the following manifold blocks:

- CPX-M-AB-4-M12X2-5POL-T
- CPX-AB-8-KL-4POL.



When using manifold block CPX-AB-8-KL-4POL (“CageClamp” connection technology), another sensor/switch can be connected to the channel pair via terminals 24 V and E1.



## 1. System overview CPX-F8DE-P

### 1.4.6 2 two-wire sensors

This application example shows the circuitry of 2 electronic two-wire sensors on one channel pair.

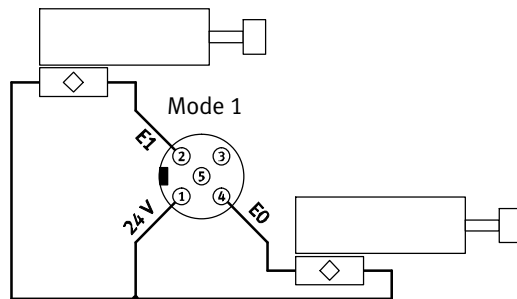

Fig. 1/8: 2 electronic two-wire sensors



The input module CPX-F8DE-P has digital inputs type 2 in accordance with IEC 61131-2. This makes it possible to use up to 8 electronic two-wire sensors.

### 1.4.7 2 safety doors on one channel pair

This application example shows the circuitry of two safety doors on one channel pair.

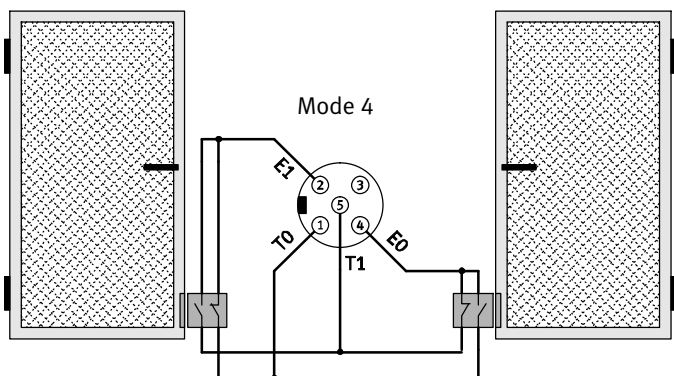

Fig. 1/9: 2 safety door sensors on one channel pair

### 1.4.8 Safety door with two N/O switches

This application example is suitable for settings subject to vibration, e.g. close to a press or stamping machine.

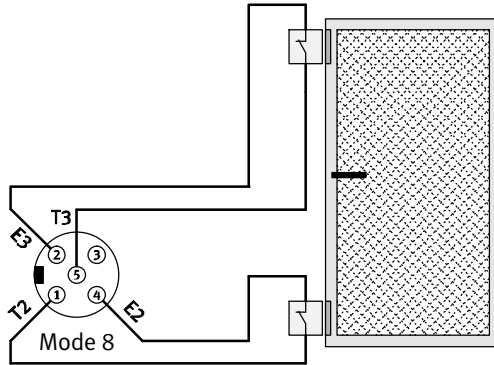

Fig. 1/10: 2 N/O switches on one channel pair



A robust version of the safety circuit is created with function mode 8. This safety function is enabled only if both switches are closed within 60 seconds of each other. If a switch was not previously opened, the channel or the module is passivated. The input module reports channel error 55: “process value”.

# Installation

## Chapter 2

## 2. Installation

# Contents

<b>2.</b>	<b>Installation</b>	<b>2-1</b>
2.1	General information about installation	2-3
2.1.1	Module-related rules for configuration	2-4
2.2	Electrical connection and display elements	2-5
2.2.1	Pin allocation on the manifold block CPX-M-AB-4-M12X2-5POL-T	2-6
2.2.2	Pin allocation on the manifold block CPX-M-AB-4-M12X2-5POL	2-7
2.2.3	Pin allocation on the manifold block CPX-AB-8-KL-4POL	2-8
2.3	Installation of the electronics module	2-9
2.3.1	Disassembling the electronics module	2-10
2.3.2	Installing the electronics module	2-10
2.4	Setting the PROFIsafe address	2-11
2.5	Connection of sensors	2-13
2.5.1	Ensuring the degree of protection	2-14

### 2.1 General information about installation



#### **Warning**

Electric voltage

Injury caused by electric shock, damage to machine and to system

- For the electrical power supply, only use PELV power circuits in accordance with IEC 60204-1 (Protective Extra Low Voltage, PELV).
- Note the general requirements of IEC 60204-1 for PELV power circuits.
- Use only voltage sources that guarantee a reliable electric separation of operating and load voltage in accordance with IEC 60204-1.
- Always connect all of the power circuits for operating and load voltage supplies  $U_{EL/SEN}$ ,  $U_{VAL}$  and  $U_{OUT}$ .

Protection from electric shock (protection from direct and indirect contact) in accordance with IEC 60204-1 (Electrical equipment of machines, General requirements) is guaranteed with the use of PELV circuits.

## 2. Installation

### 2.1.1 Module-related rules for configuration

- Plug input module CPX-F8DE-P into one of the following interlinking blocks only:
  - CPX-M-GE-EV
  - CPX-M-GE-EV-S-7/8-5POL
  - CPX-M-GE-EV-S-7/8-CIP-4P
  - CPX-M-GE-EV-S-PP-5POL
  - CPX-M-GE-EV-S-M12-5POL
  - CPX-M-GE-EV-Z-7/8-5POL
  - CPX-M-GE-EV-Z-PP-5POL
  - CPX-M-GE-EV-W-M12-5POL.
- Only operate input module with one of the following manifold blocks:
  - CPX-M-AB-4-M12X2- 5POL-T
  - CPX-M-AB-4-M12X2- 5POL
  - CPX-AB-8-KL-4POL
  - CPX-AB-ID-P.
- Only use input module in conjunction with permitted product versions of the CPX terminal ➔ Chapter 1.1.3.

## 2. Installation

### 2.2 Electrical connection and display elements

The LEDs and the module identifier can be seen through the transparent covering of the manifold block.

- 1 Product label on manifold and interlinking block
- 2 Status LED (green); one per input channel
- 3 Channel error LED (red); one per input channel
- 4 Module error LED (red)
- 5 FP-LED (green) – fail-safe mode
- 6 Module identifier F8DIP (for CPX-F8DE-P)
- 7 Area for electrical connections (here CPX-AB-8-KL-4POL)

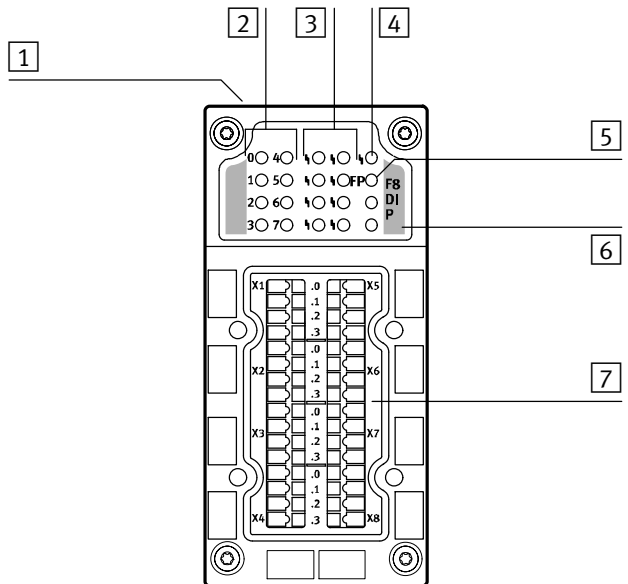

Fig. 2/1: Display and connecting elements CPX-F8DE-P



Detailed information about the LEDs → Chapter 5.3.

## 2. Installation

### 2.2.1 Pin allocation on the manifold block CPX-M-AB-4-M12X2-5POL-T

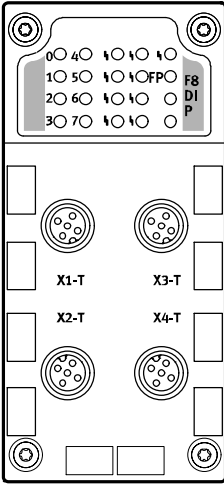
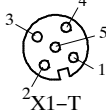
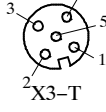
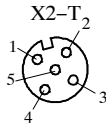
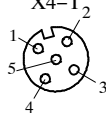
CPX-F8DE-P with manifold block CPX-M-AB-4-M12X2-5POL-T				
Manifold block	Pin allocation X1-T, X2-T		Pin allocation X3-T, X4-T	
 <p>The diagram shows the manifold block with terminal positions labeled as follows:</p> <ul style="list-style-type: none"> <li>0: 4V, 1: 5V, 2: 6V, 3: 7V</li> <li>4: 1V, 5: 0V, 6: 1V, 7: 1V</li> <li>8: OFF, 9: PO, 10: DI, 11: P</li> <li>12: F8, 13: P</li> </ul> <p>Four sockets are shown: X1-T, X2-T, X3-T, and X4-T.</p>	 <p><b>Socket X1-T</b></p> <ol style="list-style-type: none"> <li>T0</li> <li>I1</li> <li>0 V</li> <li>I0</li> <li>T1<sup>1)</sup></li> </ol>	 <p><b>Socket X3-T</b></p> <ol style="list-style-type: none"> <li>T4</li> <li>I5</li> <li>0 V</li> <li>I4</li> <li>T5<sup>1)</sup></li> </ol>	 <p><b>Socket X2-T</b></p> <ol style="list-style-type: none"> <li>T2</li> <li>I3</li> <li>0 V</li> <li>I2</li> <li>T3<sup>1)</sup></li> </ol>	 <p><b>Socket X4-T</b></p> <ol style="list-style-type: none"> <li>T6</li> <li>I7</li> <li>0 V</li> <li>I6</li> <li>T7<sup>1)</sup></li> </ol>
<p>1) Never connect functional earth (FE) with pin 5 with this connection technology. The metal thread on the manifold block is used as the functional earth for connected sensors.</p>				

Tab. 2/1: Pin allocation with M12 manifold block CPX-M-AB-4-M12X2-5POL-T



## 2. Installation

### 2.2.2 Pin allocation on the manifold block CPX-M-AB-4-M12X2-5POL

CPX-F8DE-P with manifold block CPX-M-AB-4-M12X2-5POL		
Manifold block	Pin allocation X1, X2	Pin allocation X3, X4
	<p><b>Socket X1</b></p> <ul style="list-style-type: none"> <li>1: 24 V</li> <li>2: I1</li> <li>3: 0 V</li> <li>4: I0</li> <li>5: FE</li> </ul> <p><b>Socket X2</b></p> <ul style="list-style-type: none"> <li>1: 24 V</li> <li>2: I3</li> <li>3: 0 V</li> <li>4: I2</li> <li>5: FE</li> </ul>	<p><b>Socket X3</b></p> <ul style="list-style-type: none"> <li>1: 24 V</li> <li>2: I5</li> <li>3: 0 V</li> <li>4: I4</li> <li>5: FE</li> </ul> <p><b>Socket X4</b></p> <ul style="list-style-type: none"> <li>1: 24 V</li> <li>2: I7</li> <li>3: 0 V</li> <li>4: I6</li> <li>5: FE</li> </ul>
FE = functional earth n.c. = free (not connected)		

Tab. 2/1: Pin allocation with M12 manifold block CPX-M-AB-4-M12X2-5POL



The metal thread of the manifold block CPX-M-AB-4-M12X2-5POL is internally connected to pin 5 (functional earth FE).

## 2. Installation

### 2.2.3 Pin allocation on the manifold block CPX-AB-8-KL-4POL

CPX-F8DE-P with manifold block CPX-AB-8-KL-4POL			
Manifold block	Left terminal strip allocation		Right terminal strip allocation
	<b>X1</b> .0 .1 .2 .3 <hr/> <b>X2</b> .0 .1 .2 .3 <hr/> <b>X3</b> .0 .1 .2 .3 <hr/> <b>X4</b> .0 .1 .2 .3	<b>X1</b> 0: 24 V DC 1: 0 V 2: I0 3: FE <b>X2</b> 0: T0 1: T1 2: I1 3: FE <b>X3</b> 0: 24 V DC 1: 0 V 2: I2 3: FE <b>X4</b> 0: T2 1: T3 2: I3 3: FE	.0 .1 .2 .3 <hr/> <b>X5</b> .0 .1 .2 .3 <hr/> <b>X6</b> .0 .1 .2 .3 <hr/> <b>X7</b> .0 .1 .2 .3 <hr/> <b>X8</b> .0 .1 .2 .3
FE = functional earth n.c. = free (not connected)			

Tab. 2/2: Pin allocation with terminal strip manifold block

### 2.3 Installation of the electronics module



#### Note

Incorrect handling can cause damage to the electronics modules.

- Never pull/push the electronics module from/into the interlinking block when the power is switched on.

Electronics modules include electrostatically sensitive devices.

- Observe the handling specifications for electrostatically sensitive devices.
- Discharge static electricity from your body before assembling or disassembling modules to protect the modules.

Before the CPX terminal can be extended or converted, it must first be unscrewed and dismantled. Information can be found in the CPX system description.

CPX terminals are supplied from the factory completely assembled. It may be necessary to disassemble and assemble the manifold blocks for the following reasons:

- Replacement of the manifold block
- Changing the DIL switch setting → Chapter 2.4, Setting the PROFIsafe address
- Replacement of a defective electronics module.

The plugs connected to the manifold block can remain attached while disassembling the manifold block.

## 2. Installation

### 2.3.1 Disassembling the electronics module

1. Switch off the operating and load voltage supply of the CPX terminal.
2. Unscrew retaining screws **10** → Fig. 1/1.
3. Carefully lift off manifold block **1**, **2** or **3**.
4. If required: carefully remove electronics module **4** from the bus bars.

### 2.3.2 Installing the electronics module

- Before assembly ensure that the PROFIsafe address on the electronics module is correctly set → Chapter 2.4.



#### Note

- Handle the components with care.
- Ensure that the interlinking block is clean and free of foreign matter, especially on and near the contact rails.
- Check the seal and the sealing surfaces. Replace damaged parts.
- Ensure that connecting surfaces are clean. This helps to optimise the sealing action and to prevent contact errors.

1. Position input module correctly in interlinking block **6** without tilting it and press it into the stop → Fig. 1/1.
2. Align manifold block **1**, **2** or **3** and fit to electronics module **4**.
3. Screw the retaining screws **10** into the existing threads.
4. Tighten retaining screws crosswise.  
Tightening torque: 0.9 ... 1.1 Nm.

## 2. Installation

### 2.4 Setting the PROFIsafe address

The input module is controlled by an F-Host via PROFIsafe and needs a PROFIsafe address for unique identification of the F-host. The PROFIsafe address is defined by configuration software and is set using binary coding by the 10x DIL switch. Both settings must match.

Permitted PROFIsafe addresses: 1 ... 1022

The 10x DIL switch is located directly on the electronics module and can be set while the manifold block is not mounted → Fig. 1/1.



The DIL switch setting is evaluated during the startup phase of the firmware.

1. Set the DIL switch carefully with a small screwdriver.
2. Switch the input module on again to use a changed address.

Information about address allocation via configuration software can be found in the relevant software documentation.

PROFIsafe address 0 is preset at the factory.

- 1 Addressing example  
PROFIsafe  
address 578
- 2 Decimal value  
when set to ON
- 3 Calculation  
example – DIL  
switch 2, 7 and  
0 (10) set ON

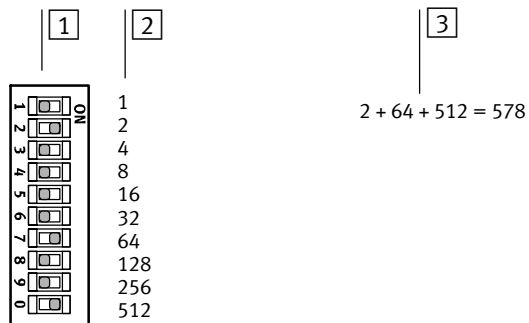

Fig. 2/2: 10x DIL switch for setting the PROFIsafe address – binary coded

## 2. Installation



### Note

Malfunctions.

- Prior to commissioning the automated system. Set PROFIsafe address in accordance with installation planning and applicable allocation rules.



### Note

This PROFIsafe module accepts every PROFIsafe host address and thus fulfils the requirements of PROFIsafe address type 1.



### Note

Damage to the electronics module due to incorrect handling.

- Switch off operating and load voltage supplies before assembly and installation work.
- Do not switch on the operating and load voltage supplies until the product has been fully assembled and all installation work has been completed.

Procedure:

1. Switch off the operating and load voltage supply of the CPX terminal.
2. Remove the manifold block → Chapter 2.3.1.
3. Set PROFIsafe address on binary coded 10x DIL switch → Fig. 2/2.  
Permitted PROFIsafe addresses: 1 ... 1022
4. Reinstall the manifold block → Chapter 2.3.2.
5. Switch input module on again.

### 2.5 Connection of sensors

**Note**

Damage to the electronics module due to incorrect handling.

- Switch off operating and load voltage supplies before assembly and installation work.
- Do not switch on the operating and load voltage supplies until the product has been fully assembled and all installation work has been completed.

The sensors for the input module are connected to the manifold block. For example, this means that the plugs and cables remain installed on the manifold block when replacing the electronics module.

Maximum permitted cable lengths to the sensors (→ Appendix A.1, Tab. A/2).

Festo plugs (→ [www.festo.com/catalogue](http://www.festo.com/catalogue)).

**Note**

Cross-circuit monitoring of sensor wiring depends on the function mode being used (→ Chapter 1.3.3).

- Ensure that cross circuits in power circuits with voltages above the maximum input voltage are not possible using appropriate installation measures.

## 2. Installation

### 2.5.1 Ensuring the degree of protection

The degree of protection on the input module depends on the manifold block being used (→ Appendix A.2) and on the plugs, cover caps and coverings.

- Use connection hardware with the required degree of protection.
- Use cover caps to seal unused M12 connections.
- Close terminal strip of manifold block CPX-AB-8-KL-4POL with cover AK8KL.

Accessories → [www.festo.com/catalogue](http://www.festo.com/catalogue)



# Commissioning

## Chapter 3

## Contents

<b>3.</b>	<b>Commissioning .....</b>	<b>3-1</b>
3.1	General information .....	3-3
3.2	Device master file (GSDML and GSD) .....	3-4
3.3	Module identification .....	3-4
3.4	Preparing for commissioning .....	3-5
3.5	Commissioning steps .....	3-6
3.6	Setting the PROFIsafe parameters .....	3-7
3.7	Reading out the CPX module parameters .....	3-9
	3.7.1 Parameter and signal display with the operator unit CPX-MMI-1 ..	3-11
3.8	Configuration with Siemens STEP 7 (example). .....	3-13
	3.8.1 Addressing example .....	3-16

### 3. Commissioning

#### 3.1 General information

Operation of the input module is only possible with the following bus nodes, device master files and the following controller software:

Bus node	Device master file	Controller software
– CPX-FB13 from Rev. 30 <sup>1)</sup>	PROFIBUS: from CPXe059E.gsd dated 17.03.2014	Compatible with device PROFIsafe V2 (Version 2.4)
– CPX-FB33 from Rev. 21 <sup>1)</sup> – CPX-M-FB34 from Rev. 21 <sup>1)</sup> – CPX-M-FB35 from Rev. 21 <sup>1)</sup>	PROFINET IO: from GSDMLV2.31 Festo CPX20141203.xml dated 03.12.2014	
– CPX-FB43 from Rev. 50 <sup>1)</sup> – CPX-M-FB44 from Rev. 50 <sup>1)</sup> – CPX-M-FB45 from Rev. 50 <sup>1)</sup>	PROFINET IO: from GSDMLV2.34 Festo CPX20200210.xml dated 10.02.2020	
1) Revision code → Bus node product labelling		

Tab. 3/1: Required versions

The configuration depends on the control system. The basic approach and required configuration data are presented in the following pages.

### 3. Commissioning

## 3.2 Device master file (GSDML and GSD)

In conjunction with the input module CPX-F8DE-P, you will need a current GSDML/GSD device master file for configuration and programming.

#### Reference source

current versions of the GSDML/GSD files for CPX terminals are available on the Festo website → [www.festo.com/sp](http://www.festo.com/sp).

After importing the GSDML/GSD file into the project of the F-host configuration program, you can select and edit the CPX terminal with the input module CPX-F8DE-P in the configuration program.



The configuration, parameterisation and commissioning of the CPX terminal with CPX-F8DE-P depend on the control system.

Detailed information can be found in the documentation for the control system and the online help of the configuration program.

## 3.3 Module identification

Each module has a separate identifier (module identifier).

- Import the module identifiers – as in the CPX terminal arranged from left to right – into your configuration program.

Module (order code)	Module identifier <sup>1)</sup>	Assigned I/O bytes <sup>2)</sup>
CPX-F8DE-P	F8DI-P	6 bytes I + 7 bytes O
1) Module identifier in the operator unit		
2) 4 bytes each are used exclusively for PROFI-safe communications		

Tab. 3/2: Module identifier of the input module CPX-F8DE-P

### 3. Commissioning

#### 3.4 Preparing for commissioning

1. Ensure that the CPX terminal is mounted correctly  
➔ CPX system description.
2. Check the wiring (connecting cables, contact assignment)  
➔ Chapter 2.2.1.
3. Dismantle the manifold block of the input module  
➔ Chapter 2.3.1.
4. Check the input module is in good condition.
5. Set the PROFIsafe address on the input module with DIL switches and install the manifold block ➔ Chapter 2.3.2.

### 3.5 Commissioning steps



Detailed information about configuring, programming and commissioning in combination with the relevant F-Host can be found in the F-Host manufacturer's documentation. You can find notes on the configuration and commissioning of the CPX terminal in the description of the bus node.

1. Integrate the GSDML/GSD file in the configuration software of the F-Host → Description of the bus node.
2. Configure and parameterise the CPX terminal including the input module with the configuration software of the F-Host.
  - Import CPX terminal into the configuration → Description of the bus node
  - If necessary: set the starting addresses for inputs and outputs
  - Set default parameters on the input module
  - Set PROFIsafe parameters on the input module → Chapter 3.6.
3. Create and load the safety program.
4. Commission CPX terminal on field bus (PROFIBUS or PROFINET IO) and validate its behaviour in the test run.

### 3.6 Setting the PROFIsafe parameters

PROFIsafe-specific parameters can be viewed or set with the configuration device of the F-Host (e.g. HW Config). They are designated in accordance with the PROFIsafe profile in the GSDML/GSD file. They can only be accessed by entering the password in the F-Host.



The function mode is set via the output data on the process image → Chapter 1.2.3.

PROFIsafe parameters	General description	For CPX-F8DE-P, the following applies:	Value
F_Check_iPar	Determines whether the individual device parameters (CPX module parameters) are to be taken into account when checking the consistency (CRC calculation) of the F-user data telegram.	– CPX-F8DE-P does not provide individual device parameters.	– No check (cannot be altered)
F_Check_SeqNr	Determines whether the sequence number is to be taken into account when checking the consistency (CRC calculation) of the F-user data telegram.	– CPX-F8DE-P only supports the V2 mode. The sequence number is always included in the CRC2 test in the V2 mode.	– Check (cannot be altered)
F_SIL	The expected safety integrity level (SIL) of the input module.	– CPX-F8DE-P supports the SIL 3 requirement.	– SIL 3
F_CRC_Length	Communicates the expected length of CRC2 key to the F-Host in the safety telegram.	– This parameter cannot be changed with CPX-F8DE-P because the CRC2 key always occupies 3 bytes.	– 3 CRC bytes (cannot be altered)
F_Block_ID	Shows if the data record for the F_iPar_CRC value has been extended by 4 bytes. The parameter F_Block_ID has the value 1 if the parameter F_iPar_CRC is present, otherwise it has the value 0.	– CPX-F8DE-P does not provide individual device parameters.	– 0 (cannot be altered)

### 3. Commissioning

<b>PROFIsafe parameters</b>	<b>General description</b>	<b>For CPX-F8DE-P, the following applies:</b>	<b>Value</b>
F_Par_Version	Displays the PROFIsafe operating mode of the device. Setting 1 corresponds to PROFIsafe V2 mode.	– CPX-F8DE-P operates exclusively in PROFIsafe V2-MODE.	– 1 (cannot be altered)
F_Source_Add (PROFIsafe source address)	Unique PROFIsafe source address of the F-Host.	– Unique PROFIsafe source address of the F-Host.	Specified by the F-Host
F_Dest_Add (PROFIsafe target address)	Unique PROFIsafe target address of the F-Device within the PROFIsafe network. The target address set by the configuration software must match the PROFIsafe address set on the input module with the DIL switch.	– CPX-F8DE-P compares both settings to check the authenticity of the connection → Chapter 2.4 .	– 1 ... 1022 (0 and 1023 are not permitted)
F_WD_Time	Time period ( <b>Watchdog Time</b> ) within which a valid current safety telegram must be received from the F-Host. Otherwise the F-Device switches into a safe state.	– The time period must be short enough that the system can react fast enough to communication failures or malfunctions. On the other hand, the time period must be long enough to tolerate typical delays in transmission. The cycle time for calling the safety program must be shorter than the time period set here.	– 50 ... 65535 [ms]
F_iPar_CRC	CRC via the individual device parameters (iParameters).	– CPX-F8DE-P does not provide individual device parameters.	– 0 (cannot be altered)

Tab. 3/3: PROFIsafe parameters



### 3. Commissioning

#### 3.7 Reading out the CPX module parameters



Further information on parameterisation can be found in the CPX system description P.BE-CPX-SYS-... or in the description of the bus node.

The following table provides an overview of the existing CPX module parameters on the input module.

<b>Overview of module parameters CPX-F8DE-P</b>			
<b>Function number <sup>1)</sup></b>	<b>Bit</b>	<b>Module parameters</b>	<b>Default</b>
4828 + m * 64 + <b>1 ... 5</b>	0 ... 7	Reserved	–
4828 + m * 64 + <b>8 ... 21</b>	0 ... 7	reserved for PROFIsafe	–
4828 + m * 64 + <b>22</b>	0 ... 7	Position of 10x DIL switch for the PROFIsafe address of the module, bits 0 ... 7	0 <sup>1)</sup>
4828 + m * 64 + <b>23</b>	0, 1	Position of 10x DIL switch for the PROFIsafe address of the module, bits 8 and 9	0 <sup>1)</sup>
1) Parameters read-only via operator unit and command interpreter (CI).			

Tab. 3/4: Overview – module parameters CPX-F8DE-P

### 3. Commissioning

Module parameter: DIL switch setting		Operator unit																											
Function no.	4828 + m * 64 + <b>22</b> m = module number (0 ... 47) 4828 + m * 64 + <b>23</b>																												
Description	Indicates the switch setting of the PROFIsafe address selector switch on the input module. In addition to the PROFIsafe parameter F_Dest_Add (➔ Chapter 3.6) the setting of the address selector switch can be read out by CPX parameters for diagnostic purposes – e.g. with the operator unit (read only).																												
Bit	Low byte (4828 + m * 64 + <b>22</b> ) Bit 0: SW 0 Bit 1: SW 1 ... Bit 7: SW 7 High byte 4828 + m * 64 + <b>23</b> ) Bit 0: SW 8 Bit 1: SW 9 Bit 2 ... 7: reserved or 0	[PROFIsafe Addr]																											
Values	<table border="1"> <tr> <td>Bit 7</td><td>Bit 6</td><td>Bit 5</td><td>Bit 4</td><td>Bit 3</td><td>Bit 2</td><td>Bit 1</td><td>Bit 0</td><td></td> </tr> <tr> <td>SW 7</td><td>SW 6</td><td>SW 5</td><td>SW 4</td><td>SW 3</td><td>SW 2</td><td>SW 1</td><td>SW 0</td><td>low byte</td> </tr> <tr> <td>0</td><td>0</td><td>0</td><td>0</td><td>0</td><td>0</td><td>SW 9</td><td>SW 8</td><td>high byte</td> </tr> </table>	Bit 7	Bit 6	Bit 5	Bit 4	Bit 3	Bit 2	Bit 1	Bit 0		SW 7	SW 6	SW 5	SW 4	SW 3	SW 2	SW 1	SW 0	low byte	0	0	0	0	0	0	SW 9	SW 8	high byte	
	Bit 7	Bit 6	Bit 5	Bit 4	Bit 3	Bit 2	Bit 1	Bit 0																					
SW 7	SW 6	SW 5	SW 4	SW 3	SW 2	SW 1	SW 0	low byte																					
0	0	0	0	0	0	SW 9	SW 8	high byte																					
	0: switch element is set to OFF 1: switch element is set to ON	[0] [1]																											
Comment	This parameter can only be changed by changing the DIL switch setting (read only).																												

Tab. 3/5: DIL switch setting

### 3. Commissioning

#### 3.7.1 Parameter and signal display with the operator unit CPX-MMI-1

The universal operator unit CPX-MMI-1 offers convenient functions that support you during the commissioning process. You can use the operator unit to view and if necessary modify the CPX module parameters. The PROFIsafe parameters of the input module cannot be modified with the operator unit for safety engineering reasons.



General information on the operator unit and on commissioning the CPX terminal with the operator unit can be found in the description P.BE-CPX-MMI1-1...

The following section requires familiarity with the basic functions of the operator unit.

The main menu of the operator unit displays the name [F8DI-P Input Module Safety] for the input module. The header of the operator unit displays the short text [F8DI-P]. An example is shown in the diagram below:

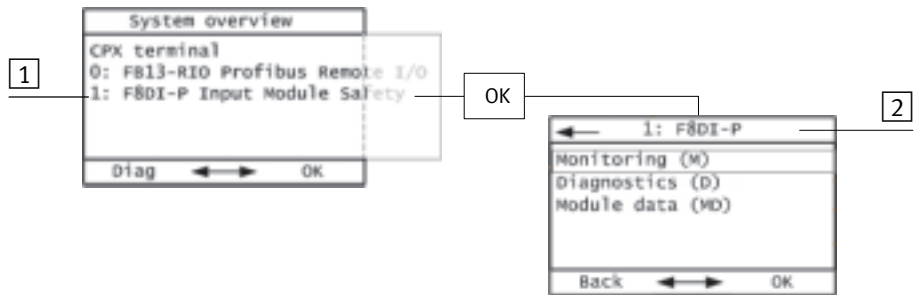

**1** Module identifier in main menu (here at position 1)

**2** Module identifier in the header of the system submenu for a module

Fig. 3/1: Module identifier of the input module CPX-F8DE-P on the operator unit

### 3. Commissioning

The following image shows the specific views for the input module CPX-F8DE-P as an example.

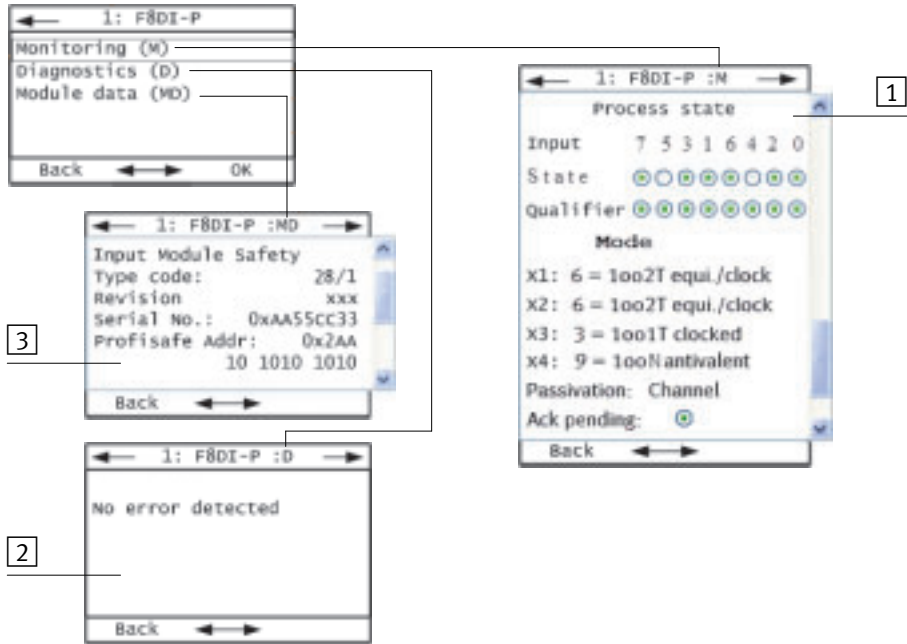

1 Monitoring (M)

3 Module data (MD)

2 Diagnostics (D)

Fig. 3/2: Specific views for CPX-F8DE-P on the operator unit

When calling up the command [Monitoring (M)], the logical statuses of the 8 input channels and the related qualification bits (Qualifiers) are displayed in accordance with the set function modes. The display of input signals and qualification bits corresponds here to the PROFIsafe process image.

## 3.8 Configuration with Siemens STEP 7 (example).

The configuration examples shown in this chapter are based on the use of a Siemens PLC and the Siemens STEP 7 version 5.4 configuration and programming software with Distributed Safety version 5.4. PROFIBUS or PROFINET IO is used as the bus system.

The following section requires familiarity with the operation of the STEP 7 software.



Information on the configuration and commissioning of the CPX terminal can be found in the description of the bus node.

1. Integrate the GSDML/GSD file in the configuration software of the F-Host → Description of the bus node.
2. Configure the CPX terminal including the input module with the configuration software of the F-Host:  
Import CPX terminal into the configuration → Description of the bus node.
3. In the configuration table double-click the row of the input module CPX-F8DE-P.  
The “Properties – F8DE-P” dialogue box is displayed.

“Addresses”  
tab

4. Set the required starting addresses for inputs and outputs → Fig. 3/3.

“Parameters”  
tab

5. Set default parameters on the input module.

In online mode the PROFIsafe addresses of the DIL switch settings are displayed here.

### 3. Commissioning

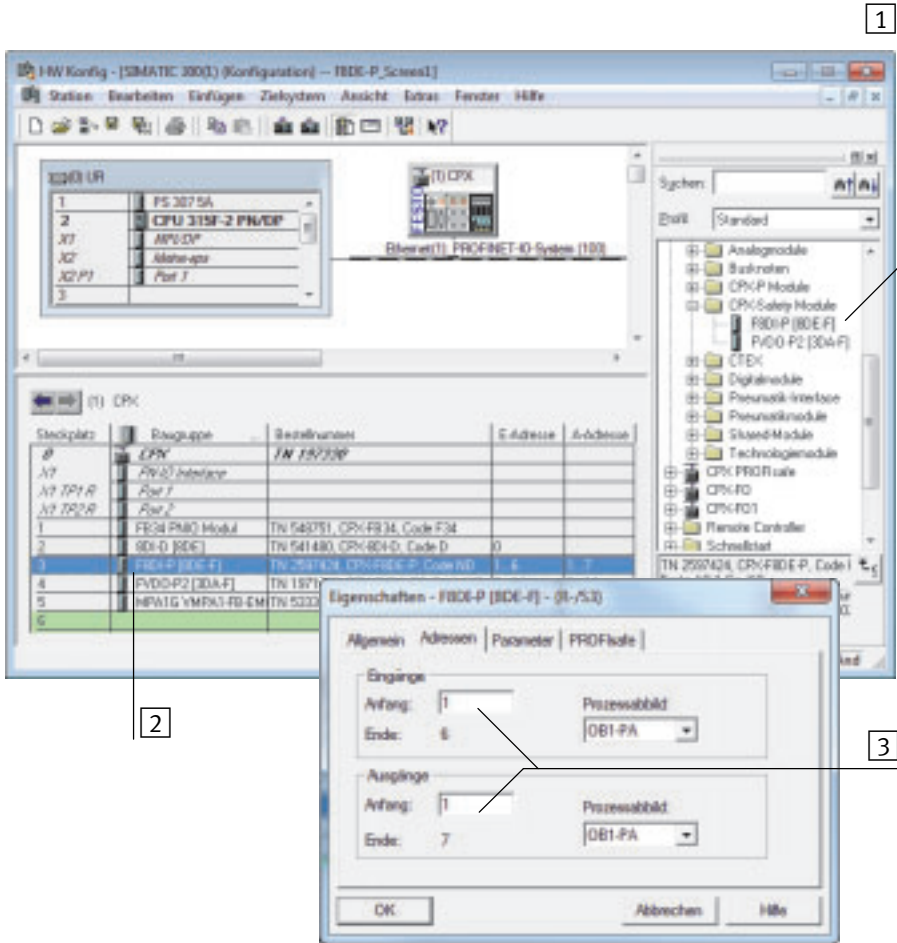

- 1 Input module CPX-F8DE-P in the hardware catalogue
- 2 Input module CPX-F8DE-P in the configuration table of the CPX terminal
- 3 Start addresses of the input module for inputs and outputs (here 1)

Fig. 3/3: CPX terminal configuration with Siemens STEP 7 – HW Config

### 3. Commissioning

“PROFIsafe”  
tab

6. Set a correct PROFIsafe target address for parameter [F\_Dest\_Add] → Fig. 3/4.  
The target address must match the PROFIsafe address set on the input module with the DIL switch → Fig. 2/2.

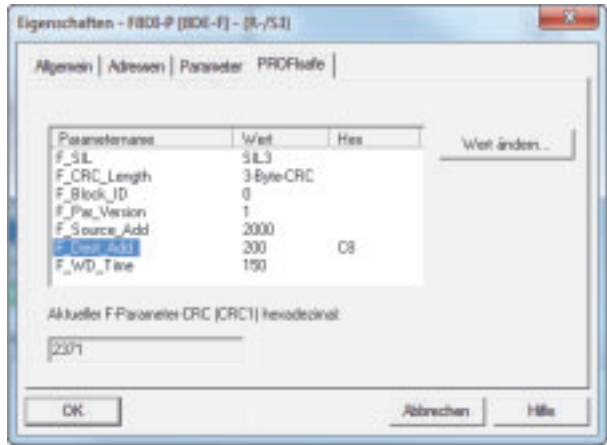

Fig. 3/4: PROFIsafe parameters



In this tab you have access to the PROFIsafe parameters of the input module. You can find detailed information on the individual parameters in Chapter 3.6.

### 3. Commissioning

#### 3.8.1 Addressing example

Addressing example: CPX terminal with MPA pneumatics

Addresses used from input/output byte 0:

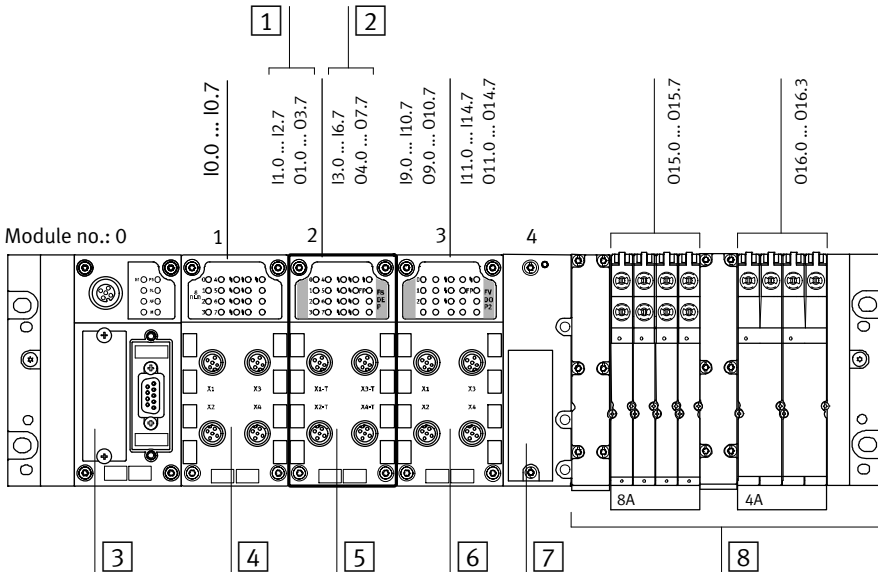

- 1 F-usage data: 2 byte safety inputs and 3 byte safety outputs
- 2 Unusable range (1 byte each for status/control and 3 bytes for CRC)
- 3 Bus node CPX-FB13
- 4 Input module with 8 digital inputs and diagnostics
- 5 Input module CPX-F8DE-P
- 6 Output module CPX-FVDA-P2
- 7 Pneumatic interface
- 8 MPA pneumatics

Fig. 3/5: Addressing example



### 3. Commissioning

<b>No.</b>	<b>Module</b>	<b>I address</b>	<b>O address</b>
0	Bus node CPX-FB13	–	–
1	Digital 8x input module with single-channel diagnostics CPX-8DI-D	0	–
2	Safety input module CPX-F8DE-P	1 ... 6	1 ... 7
3	Safety output module CPX-FVDA-P2	9 ... 14	9 ... 14
4	MPA: pneumatic interface	–	–
5	MPA: pneumatic module VMPA1-FB-EMG-8 [8DO]	–	15
6	MPA: pneumatic module VMPA2FBEMG4 [4DO]	–	16

Tab. 3/6: Input and output addresses for the example → Fig. 3/5

### 3. Commissioning

# Operation

## Chapter 4









## Contents

<b>4.</b>	<b>Operation .....</b>	<b>4-1</b>
4.1	LED status indication .....	4-3
4.1.1	Behaviour during the start-up phase (Startup) .....	4-4
4.1.2	Normal operating status .....	4-4







## 4. Operation

### 4.1.1 Behaviour during the start-up phase (Startup)





No.	Status LED	Channel error LED	FP LED	Module error LED	I/O image	Event/status
1				 500 ms	0	Switch on the operating voltage supply $U_{EL/SEN}$ (Startup)
2					0	Waiting for secure communication with the control unit (safety parameter)

Tab. 4/1: Behaviour during the switch-on phase

### 4.1.2 Normal operating status

Status LED	Channel error LED	FP LED	Module error LED	I/O image	Event/status
Like sensor signal	 <sup>1)</sup>			1 <sup>2)</sup>	PROFIsafe communication running.
Like sensor signal	 <sup>1)</sup>			0	PROFIsafe communication running. Channel error detected at input.
		 LED flashes quickly			PROFIsafe communication running. Operator Acknowledge Requested
<p>1) Refers to the input channel to which the relevant status LED is assigned. 2) Input image based on calculation of operating mode.</p>					

#### 4. Operation

Status LED	Channel error LED	FP LED	Module error LED	I/O image	Event/status
					Parameter received, but no PROFIsafe communication. Possible causes of the error: <ul style="list-style-type: none"> <li>– Parameter error</li> <li>– Communication timeout</li> <li>– Communication errors</li> <li>– PROFIsafe address is not correct.</li> </ul>
					Error. Device in a safe functional condition.
					Possible causes of the error: <ul style="list-style-type: none"> <li>– Module error</li> <li>– Undervoltage</li> <li>– Overvoltage</li> <li>– Overtemperature</li> <li>– Channel error with module passivation.</li> </ul>
					Application running, PROFIsafe parameters not present.
			 LED flashes quickly		Self-test error

Tab. 4/2: Normal operating status

## 4. Operation



# Diagnostics and error handling

## Chapter 5

## Contents

<b>5.</b>	<b>Diagnostics and error handling .....</b>	<b>5-1</b>
5.1	Overview .....	5-3
5.2	Error characteristics .....	5-4
5.3	Diagnostics using LEDs .....	5-6
	5.3.1 Behaviour in response to original module errors .....	5-10
	5.3.2 Behaviour in response to channel errors .....	5-11
5.4	Diagnostics via the bus node .....	5-13
	5.4.1 Diagnostics with the operator unit CPX-MMI .....	5-13

## 5.1 Overview

The CPX terminal offers extensive options for diagnostics and error handling. The input module supports the following diagnostic and error handling facilities:

Diagnostics option		Brief description	Reference
On-site diagnostics	LED	The LEDs on the input module display errors in the input channel and modules.	→ Chapter 5.3
	Operator unit (MMI)	Diagnostic information from the input module can be displayed conveniently on the operator unit with menu-guided navigation.	→ Chapter 5.4.1 and description of the operator unit
Diagnostics via bus node	System status query (status bits query)	8 status bits of the CPX terminal display common diagnostics messages (global error messages)	→ CPX system description and description of the bus node
	I/O diagnostics interface	CPX-F8DE-P reports specific malfunctions to the CPX bus node as error numbers. The I/O diagnostic interface enables these data to be queried.	→ Tab. 5/2 → CPX system description
	Fieldbus-specific diagnostics	Depends on the bus node (e.g. DPV1)	→ Description of the bus node

Tab. 5/1: Diagnostics options

Reported errors can be evaluated, depending on the bus protocol used. The errors are indicated on-site via the error LEDs and, if necessary, can be evaluated with the operator unit.



Information about the diagnostic options on the complete CPX terminal and/or all modules can be found in the CPX system description and/or in the description of the bus node.



**Note**

Ensure that the diagnostic messages cannot be evaluated for safety-related measures.

## 5.2 Error characteristics

The input module distinguishes between types of error and responds accordingly with:

- Channel passivation if a failure can be allocated to precisely that channel (e.g. with detection of shorts across contacts).
- Module passivation if the error that occurs cannot be allocated precisely to one channel and a component defect is not detected (e.g. communication failure with PROFIsafe).
- Safe shut-down if a single microcontroller detects the failure of a component that is required to run the program.
- Passivation as a result of the incorrect setting of a function mode.

The input module can only transmit certain error messages as a function of the selected function mode.

No.	Error messages	Function mode										
		0	1	2	3	4	5	6	7	8	9	10
02	Channel error short circuit 24 V	–	–	–	✓	✓	–	✓	✓	✓	–	–
02	Module error short circuit 0 V clock output T1357	✓	✓	✓	✓	✓	✓	✓	✓	✓	✓	✓
03	Channel error wire break	–	–	–	–	✓	–	–	✓	–	–	–
05	Module error undervoltage	✓	✓	✓	✓	✓	✓	✓	✓	✓	✓	✓
29	Channel error configuration e.g. invalid function mode	–	–	–	–	–	–	–	–	–	–	–
55	Channel error process value	–	–	–	–	–	✓	✓	–	✓	✓	✓
61	Module error overvoltage	✓	✓	✓	✓	✓	✓	✓	✓	✓	✓	✓
65	Module error F_DEST_ADD different	✓	✓	✓	✓	✓	✓	✓	✓	✓	✓	✓

## 5. Diagnostics and error handling

No.	Error messages	Function mode										
		0	1	2	3	4	5	6	7	8	9	10
66	Module error communication	✓	✓	✓	✓	✓	✓	✓	✓	✓	✓	✓
67	Module error communication timeout	✓	✓	✓	✓	✓	✓	✓	✓	✓	✓	✓
68	Channel error cross circuit	-	-	-	✓	✓	-	✓	✓	✓	-	-
69	Module error parameter	✓	✓	✓	✓	✓	✓	✓	✓	✓	✓	✓
75	Module error overtemperature	✓	✓	✓	✓	✓	✓	✓	✓	✓	✓	✓
80	Channel error channel function	✓	✓	✓	✓	✓	✓	✓	✓	✓	✓	✓
145	Module error in self-test	✓	✓	✓	✓	✓	✓	✓	✓	✓	✓	✓

Tab. 5/2: Error messages

### 5.3 Diagnostics using LEDs

The following LEDs for on-site diagnostics are located under the transparent covering of the module:

- 1 Module error LED (red)
- 2 FP-LED (green) – Fail-safe mode Protocol
- 3 Channel error LED (red); one per input channel
- 4 Status LED (green); one per input channel

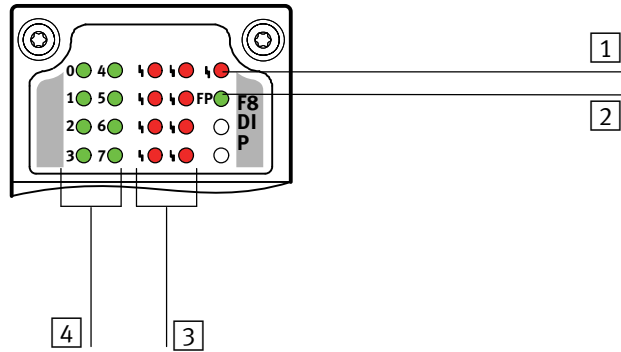

Fig. 5/1: LED display of the input module CPX-F8DE-P



**Note**

The LED display of the input module is not designed for safety purposes.

- Please note that these LEDs should **not** be used for evaluation during safety-related activities.

When switching on the operating voltage supply  $U_{EL/SEN}$ , module error LED 1 lights for approx. 500 ms.





The FP-LED 2 flashes until the input module is correctly parameterised by a PROFIsafe master.

In the normal operating status, the following LEDs light up:

- FP-LED 2
- Status LEDs 4 of the active input channels

The status LEDs on inactive input channels and the module error LEDs 1 and channel error LEDs 3 do not light.



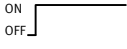

## 5. Diagnostics and error handling

<b>Module error LED</b>			
<b>LED (red)</b>	<b>Sequence</b>	<b>Status</b>	<b>Significance/error handling</b>
 <p>LED is off</p>		Error-free operation	–
 <p>LED flashes quickly</p>		<ul style="list-style-type: none"> <li>– Self-test error, input module in safe mode</li> <li>– Internal communication problem</li> </ul>	<ul style="list-style-type: none"> <li>• Switch operating voltage on and off (Power Off/On). <sup>1)</sup></li> </ul>
 <p>LED on</p>		<p>Module error</p> <ul style="list-style-type: none"> <li>– Undervoltage</li> <li>– Overvoltage</li> <li>– Overtemperature</li> <li>– Absence of safety parameterisation</li> <li>– Defective safety communication</li> <li>– Channel error during “module-based passivation” configuration</li> </ul>	<ol style="list-style-type: none"> <li>1. Remedy cause of error</li> <li>2. Correct parameterisation</li> <li>3. Reintegrate input module</li> </ol>



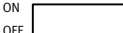

1) If self-test errors reoccur: replace input module.

Tab. 5/3: Module error LED

## 5. Diagnostics and error handling

Channel error LED			
LED (red)	Sequence	Status	Significance/error handling
 LED is off		Error-free operation	–
 LED flashes	Flash code is error-specific	<ul style="list-style-type: none"> <li>– Short-circuit with 24 V</li> <li>– Wire break</li> <li>– Cross circuit</li> <li>– Functional error</li> <li>– Module expects reintegration</li> </ul>	<ul style="list-style-type: none"> <li>• Error analysis and remedial action in accordance with Tab. 5/8</li> </ul>
 LED illuminated		<ul style="list-style-type: none"> <li>– Configuration error</li> <li>– Invalid process value</li> </ul>	<ul style="list-style-type: none"> <li>• Error analysis and remedial action in accordance with Tab. 5/8</li> </ul>



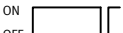







Tab. 5/4: Channel error LED

Status LED1)		Function mode										
LED (green)	Sequence	0	1	2	5	9	10	3	4	6	7	8
 LED is off		A signal is not present at the input.	A signal is not present at the input.				A signal is not present at the input.					
								The antivalent or an external clock signal is present at the input.				
 LED on		A signal is present at the input.	A static signal is present at the input.				A static signal is present at the input.					
								The module's own, equivalent clock signal is present at the input.				
 LED flashes 1x briefly out		–	A clock signal is pending at the input.				–					
1)The status LED follows the signal pending at the input channel.												

Tab. 5/5: Status LED



## 5. Diagnostics and error handling

















<b>FP-LED (FP for fail-safe protocol)</b>			
<b>LED (green)</b>	<b>Sequence</b>	<b>PROFIsafe status</b>	<b>Significance/error handling</b>
 LED flashes 2x briefly out	ON OFF 	– Waiting for safety parameters	– Input module waits for parameterisation by the F-Host
 LED flashes slowly	ON OFF 	– Address error – Communication errors – Communication timeout – Parameter error	– Set PROFIsafe address does not correlate with safety parameterisation – Safety parameterisation invalid – PROFIsafe communication cannot be established
 LED flashes quickly	ON OFF 	– Operator Acknowledge possible	– No module errors are pending, and reintegration is possible
 LED illuminated	ON OFF 	– Fail-safe protocol active	– Input module communicates with an F-Host via a PROFIsafe protocol.
 LED is off	ON OFF 	– Input module is in a safe shut-down condition	–

Tab. 5/6: FP LED

- After remedial action, reintegrate the input module.

## 5. Diagnostics and error handling

### 5.3.1 Behaviour in response to original module errors

Channel error LED	FP LED	Module error LED	Error no.	Error description	Remedy
			5	Undervoltage in supply voltage	<ul style="list-style-type: none"> <li>Correct supply voltage or remedy the short circuit</li> </ul>
			61	Overvoltage in supply voltage	<ul style="list-style-type: none"> <li>Correct supply voltage</li> </ul>
			65	Set PROFIsafe address does not correlate with safety parameterisation (F_Dest_Add)	<ul style="list-style-type: none"> <li>Check and correct set address/parameter → Chapter 2.4 and 3.8</li> <li>Transmit new parameters</li> </ul>
			66	Error in safe communication	<ul style="list-style-type: none"> <li>Rectify source of error</li> </ul>
			67	The chronological sequence for PROFIsafe communication is impaired	<ul style="list-style-type: none"> <li>Check the communication paths</li> <li>Check timeout time → Chapter 3.8</li> </ul>
			69	Error in safe parameterisation (safety parameterisation invalid)	<ul style="list-style-type: none"> <li>Check parameters in the PROFIsafe protocol</li> <li>Transmit new parameters</li> </ul>
			75	Overtemperature of the input module Short circuit/overload in a clock output	<ul style="list-style-type: none"> <li>Remedy overtemperature</li> <li>Remedy short circuit/overload on T0, T2, T4, T6</li> </ul>
			145	Input module has detected an error during the self-test	<ul style="list-style-type: none"> <li>Switch CPX terminal on again</li> <li>Replace input module</li> </ul>









Tab. 5/7: Behaviour in response to module errors

All input channels on the input module are passivated in response to module errors.





- After remedial action: reintegrate the input module.

## 5. Diagnostics and error handling

### 5.3.2 Behaviour in response to channel errors

Status LED	Channel error LED	Module error LED	Error no.	Error description	Remedy
	 LED flashes slowly		2	<ul style="list-style-type: none"> <li>– Short circuit 24 V on input signal</li> <li>– No clock signal</li> <li>– Incorrect connection technology</li> </ul>	<ul style="list-style-type: none"> <li>• Check sensors and wiring</li> <li>• Adjust connection technology or function mode</li> </ul>
			2	<ul style="list-style-type: none"> <li>– FE or 0 V connected to T1, T3, T5 or T7</li> </ul>	<ul style="list-style-type: none"> <li>• Check sensors and wiring</li> <li>• Check signal form at module input</li> </ul>
	 LED flashes 1x briefly off		3	<ul style="list-style-type: none"> <li>– No signal</li> <li>– Antivalent signal not present before release of safety function</li> <li>– FE connected to T1, T3, T5 or T7</li> </ul>	<ul style="list-style-type: none"> <li>• Check sensors and wiring</li> <li>• Check N/C contact of sensor</li> <li>• Request antivalent sensor signal</li> </ul>
			29	<ul style="list-style-type: none"> <li>– Error in the parameterisation</li> </ul>	<ul style="list-style-type: none"> <li>• Set permitted mode</li> </ul>
			55	Function mode-dependent error in process value <ul style="list-style-type: none"> <li>– Discrepancy</li> <li>– No request for standby position of the application</li> <li>– Unauthorised logical value</li> </ul>	<ul style="list-style-type: none"> <li>• Ensure correct logical and time-related reporting values of sensors</li> </ul>
				<ul style="list-style-type: none"> <li>– Incorrect manifold block installed</li> <li>– FE connected to T1, T3, T5 or T7</li> <li>– Loose contact on two-channel sensors</li> </ul>	<ul style="list-style-type: none"> <li>• Check sensors and wiring</li> </ul>

## 5. Diagnostics and error handling

Status LED	Channel error LED	Module error LED	Error no.	Error description	Remedy
	 <p>LED flashes 2x briefly off</p>		68	With clock monitoring: <ul style="list-style-type: none"> <li>– Unauthorised clock signal</li> <li>– Multiple clock signals at input</li> <li>– Clock signals swapped</li> </ul>	<ul style="list-style-type: none"> <li>• Check sensors and wiring</li> <li>• Check wiring of clock signals</li> </ul>
	 <p>LED flashes quickly</p>		80	<ul style="list-style-type: none"> <li>– Internal monitoring has detected unexpected malfunctions on the affected input channel</li> </ul>	<ul style="list-style-type: none"> <li>• Check sensors for faulty signals</li> </ul>
	 <p>LED flashes 1x briefly on</p>		–	<ul style="list-style-type: none"> <li>– Channel error is rectified, qualification bit is still '0'</li> </ul>	<ul style="list-style-type: none"> <li>• Acknowledge error</li> <li>• Reintegrate input module</li> </ul>
○	○		–	<ul style="list-style-type: none"> <li>– No signal at module input</li> <li>– Input signal follows the cycle after excessive delay</li> <li>– Loose contact, signal fails</li> </ul>	<ul style="list-style-type: none"> <li>• Check sensors and wiring</li> <li>• Check signal form at module input</li> </ul>
1) Module error LED lights while 'channel-based passivation' is disabled.					

Tab. 5/8: Behaviour in response to channel errors

- After remedial action: always reintegrate the input module.

## 5.4 Diagnostics via the bus node



Information on diagnostics of the bus node can be found in the description of the corresponding bus node.

### 5.4.1 Diagnostics with the operator unit CPX-MMI

The operator unit displays current error messages from the input module in plain text.

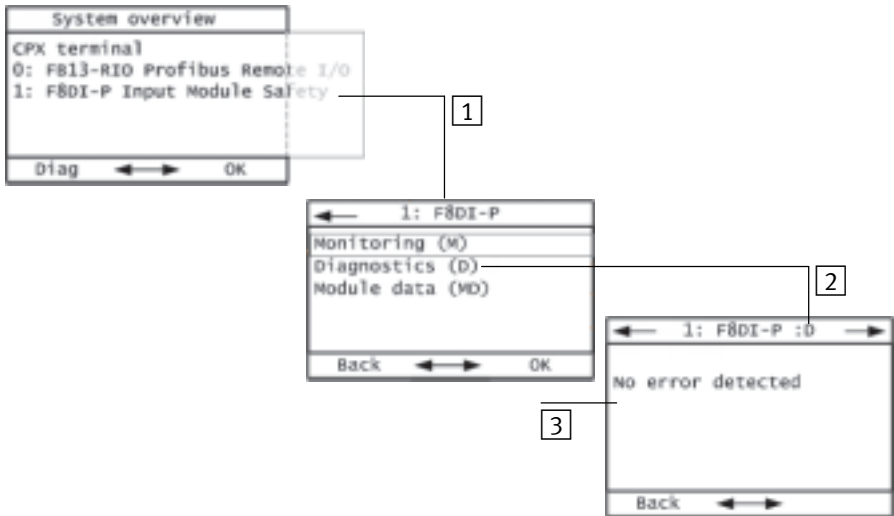

1 Select module in the main menu  
(in this case, module 1)

2 Select "Diagnostics" menu item

3 Current module errors  
(in this case, none)

Fig. 5/2: Module identifier of the input module CPX-F8DE-P on the operator unit



Furthermore, the operator unit offers access to the diagnostic memory → Description P.BE-CPX-MMI-1-...

## 5. Diagnostics and error handling

# **Service, repair, disposal**

## **Chapter 6**

6. Service, repair, disposal

## Contents

<b>6.</b>	<b>Service, repair, disposal .....</b>	<b>6-1</b>
6.1	Maintenance .....	6-3
6.2	Repair .....	6-3
6.3	Disposal .....	6-4



## 6. Service, repair, disposal

### 6.1 Maintenance

The input module does not contain any components requiring maintenance.

### 6.2 Repair

The input module CPXF8DEP does not contain any wearing parts.



#### Note

Repairs are not allowed. Repairs will result in a lapse in conformity of the input module.

A professional replacement of the electronics module is permissible.



#### Note

- Always replace the input module if there is an internal fault.
- Send the unmodified defective input module, including a description of the error and the application, back to Festo for analysis.



Disassembly and assembly of the electronics module  
→ Section 2.3.

### **6.3 Disposal**

The material used in the packaging has been specifically chosen for its recyclability.

For final disposal of the input module, please contact a certified waste disposal business for electronic (WEE) scrap.

# Technical appendix

## Appendix A

## Contents

<b>A</b>	<b>Technical appendix</b> .....	<b>A-1</b>
A.1	Technical data .....	A-3
	A.1.1 Safety characteristics .....	A-3
	A.1.2 Characteristic values of the input module .....	A-5
A.2	Technical data of the manifold blocks .....	A-8

## A.1 Technical data



General technical data CPX terminal  
 → CPX system description P.BE-CPX-SYS...

### A.1.1 Safety characteristics

Safety characteristics	Function mode										
	1	2	3	4	5	6	7	8	9	10	
Safety classification CPX-F8DE-P											
– in accordance with EN ISO 13849-1	PL d, Cat. 2 <sup>1)</sup>			to PL e, Cat. 4							
– in accordance with EN 61508	SIL 2 <sup>1)</sup>			up to SIL 3							
– in accordance with EN 62061	SIL CL 2 <sup>1)</sup>			up to SIL CL 3							
T <sub>WCDT</sub> Worst Case Delay Time (Max. internal reaction time to input signal)	[ms]	15	15	60	120	15	60	120	580	15	15
DC <sub>AVG</sub> Average Diagnostic Coverage (Average diagnostic coverage)	[%]	80 <sup>2)</sup>		99							
SFF Safe Failure Fraction (safe failure fraction)	[%]	84 <sup>3)</sup>		99							
Minimum period of request		> Internal reaction time									
PROFIsafe Watchdog Time	[ms]	F_WD_Time									
Max. reaction time to input change	[ms]	F_WD_Time + T <sub>WCDT</sub>									
1) Characteristic value if the application is tested within 24 hours: to PL e Cat. 3, SIL 3, SIL CL 3 2) Characteristic value if the application is tested within 24 h: DC <sub>AVG</sub> = 94 % 3) Characteristic value if the application is tested within 24 h: SFF = 95 %											

## A. Technical appendix

<b>Safety characteristics</b>	<b>All function modes</b>
$T_{DAT}$ Device Acknowledge Time (Internal PROFIsafe processing time) [ms]	< 20
$MTTF_d$ Mean Time To Dangerous Failure (Mean time to dangerous failure) [years]	> 2500
$PFH_D$ Probability of dangerous Failure per Hour (Probability of a dangerous failure per hour)	$1.0 \times 10^{-9}$
HFT Hardware Fault Tolerance (Hardware fault tolerance)	1
Classification in accordance with EN 61508-2:2010-05	Type B
$\beta$ Beta factor for failures resulting from common cause CCF (common cause failure) [%]	2
Max. useful life [years]	20
Safety protocol	Profile for Safety Technology on PROFIBUS DP and PROFINET IO; Version 2.4, March 2007
Type test → <a href="http://www.festo.com/sp">www.festo.com/sp</a>	The functional safety engineering of the product has been certified by an independent testing body, see EC type test certificate.
CE marking → Declaration of conformity → <a href="http://www.festo.com/sp">www.festo.com/sp</a>	in accordance with EU Machinery Directive 2006/42/EC according to EU-EMC directive 2004/108/EC
Certificate issuing authority	01/205/5444.00/15

Tab. A/1: Safety characteristics

## A. Technical appendix

### A.1.2 Characteristic values of the input module

<b>Electrical characteristic values</b>		
Nominal operating voltage DC	[V DC]	24
Residual ripple (tip to tip) in operating voltage range $U_{EL/SEN}$	[V <sub>SS</sub> ]	2
Permitted voltage tolerance	[%]	-15 ... +20
Voltage drop bypass time for the internal electronics	[ms]	10
Intrinsic current consumption at nominal operating voltage	[mA]	typ. 35
Undervoltage monitoring $U_{EL/SEN}$	[V]	$U < 19.5$ for $t > 250$ ms
Overvoltage monitoring $U_{EL/SEN}$	[V]	$U < 29.5$ for $t > 250$ ms
Potential reference of the input channels		$U_{EL/SEN}$
Electrical isolation between the channels		No
Input characteristics in accordance with IEC 61131-2 for digital inputs		Type 2
Max. accepted test pulse duration at the input	[ms]	0.7
Max. load current per clock line T0, T2, T4, T6	[A]	0.7
Max. resultant current at T1, T3, T5, T7	[A]	0.2
Max. output current at 24 V terminals	[A]	2
Max. residual current per input module	[A]	3
Cable lengths to sensor		
– Cable type LiFY11Y-OB, unshielded, 3 x 0.14 mm <sup>2</sup>	[m]	200

## A. Technical appendix

<b>Electrical characteristic values</b>		
– cable type LiF9Y11Y, unshielded, 4 x 0.10 mm <sup>2</sup>	[m]	200
– cable type LiYCY, shielded, 4 x 0.14 mm <sup>2</sup>	[m]	200

Tab. A/2: Electrical characteristic values

<b>Properties of the clock signals</b>		
Duty cycle	[ms]	50 (±6)
Pulse duration	[ms]	12
Max. time delay for input signal after clock signal		
– with falling edge	[ms]	1.7
– with rising edge (sensor switched on again)	[ms]	25

Tab. A/3: Properties of the clock signals

<b>Module characteristic values</b>	<b>Function mode</b>										
	0	1	2	3	4	5	6	7	8	9	10
Module code	28d (1Ch)										
Sub-module code	1d (01h)										
Number of inputs	8										
Switching logic inputs	PNP (positive switching)										
Compatible with fast start-up (FSU)	Yes										
Time for switch-on phase until input module is ready (start-up) [s]	< 2										
Max. tolerance time until diagnostic message of channel fault [s]	–	–	–	0.5	10	0.5	0.5	10	2	2	2

Tab. A/4: Module characteristic values



## A. Technical appendix

<b>Ambient characteristics</b>		
Ambient operating temperature	[°C]	-5 ... +50
Ambient temperature during storage and transportation	[°C]	-20 ... +70
Relative humidity (non-condensing)	[%]	5 ... 90
Contamination level in accordance with DIN EN 60664-1:2007		≤ 2
Degree of protection in accordance with IEC 60529		Dependent on the manifold block <sup>1)</sup>
Electromagnetic compatibility (EMC) – Immunity to interference and emitted interference		Declaration of Conformity ➔ <a href="http://www.festo.com/sp">www.festo.com/sp</a>
UL certification		c UL us - Recognized (OL)
1) ➔ Appendix A.2		

Tab. A/5: Ambient characteristics

## A.2 Technical data of the manifold blocks



General technical data of the CPX terminal  
 → CPX system description P.BE-CPX-SYS...

<b>CPX-M-AB-4-M12X2-5POL-T</b>	
Degree of protection in accordance with EN 60 529 <sup>1)</sup>	IP65, completely mounted, plug inserted or provided with cover cap ISK-M12
Information about housing materials	Die-cast aluminium
Connections	
– Design	4 sockets M12, metal thread, 5-pin
– Contact load	4 A
1) Degree of protection is achieved with the permitted combination with interlinking block and connectors.	

Tab. A/6: Technical data CPX-M-AB-4-M12X2-5POL-T

<b>CPX-M-AB-4-M12X2-5POL</b>	
Degree of protection in accordance with EN 60 529 <sup>1)</sup>	IP65, completely mounted, plug inserted or provided with cover cap ISK-M12
Information about housing materials	Die-cast aluminium
Connections	
– Design	4 sockets M12, metal thread, 5-pin
– Contact load	4 A
1) Degree of protection is achieved with the permitted combination with interlinking block and connectors.	

Tab. A/7: Technical data CPX-M-AB-4-M12X2-5POL

## A. Technical appendix

<b>CPX-AB-8-KL-4POL</b>	
Degree of protection in accordance with EN 60 529 <sup>1)</sup>	– IP20, completely mounted, cable connected to terminal strip – IP65, completely installed, with covering AK-8KL
Information about housing materials	Reinforced polyamide, polycarbonate
Connections	
– Design	2 terminal strips
– Contact load	4 A
1) Degree of protection is achieved with the permitted combination with interlinking block and connectors.	

Tab. A/8: Technical data CPX-AB-8-KL-4POL

<b>CPX-AB-ID-P</b>	
Degree of protection in accordance with EN 60 529 <sup>1)</sup>	IP65, completely installed
Information about housing materials	Reinforced polyamide, polycarbonate
1) Degree of protection is achieved with the permitted combination with interlinking block.	

Tab. A/9: Technical data CPX-AB-ID-P

## A. Technical appendix

# Index

## Appendix B

## Contents

<b>B</b>	<b>Index</b> .....	<b>B-1</b>
B.1	Stichwortverzeichnis .....	B-3

## A

Abbreviations, Product-specific .....	XXIV
Acknowledgement .....	XXIV
Acknowledgment sequence .....	1-17
Addressing example .....	3-16
Assembly .....	2-10

## B

Behaviour in case of error .....	5-10, 5-12
Black channel .....	XXIV

## C

Category .....	XXIV
CCF .....	XIII
Channel error LED .....	5-8
Channel-wise passivation .....	1-16
Characteristics	
CPX-AB-8-KL-4POL .....	1-5
CPX-AB-ID-P .....	1-5
CPX-F8DE-P (electronics module) .....	1-6
CPX-M-AB-4-M12X2-5POL .....	1-4
CPX-M-AB-4-M12X2-5POL-T .....	1-4
CPX-M-GE-EV .....	1-7
CPX-M-GE-EV-S-7/8-5POL .....	1-7
CPX-M-GE-EV-S-7/8-CIP-4P .....	1-7
CPX-M-GE-EV-S-M12-5POL .....	1-8
CPX-M-GE-EV-S-PP-5POL .....	1-7
CPX-M-GE-EV-W-M12-5POL .....	1-8
CPX-M-GE-EV-Z-7/8-5POL .....	1-8
CPX-M-GE-EV-Z-PP-5POL .....	1-8
Clock signal monitoring .....	XXIV
Commissioning .....	3-6
Components .....	1-4

CRC signature .....	XXIV
Cross circuit .....	XXIV
Cross-circuit monitoring .....	XXV

## **D**

Default .....	3-9
Degree of protection .....	2-14
Diagnostics	
at operator unit (MMI) .....	3-12
via LED .....	5-6
Diagnostics .....	5-6
Diagnostics option .....	5-3
DIL switch setting .....	3-10
DIL switches .....	2-11
Disassembly .....	2-10

## **E**

Electronics module .....	1-6
Error messages .....	5-4

## **F**

F usage data .....	3-16
F user data .....	1-13
Forced switch on/off .....	XXV
FP LED .....	5-9
Function mode .....	1-21

## **G**

GSD/GSDML file .....	3-4
----------------------	-----



## I

Input data .....	1-15
Intended use .....	VII
Interlinking blocks .....	1-6

## L

### LED

Channel error LED .....	5-8
FP LED .....	5-9
Module error LED .....	5-7
Status LED .....	5-8

## M

Manifold blocks .....	1-4
Connection of sensors .....	2-13
Misuse .....	X
Module error LED .....	5-7
Module identification .....	3-4
Module parameter DIL switch setting .....	3-10
Module-based passivation .....	XXVI

## O

On-site diagnostics .....	5-6
Operating status .....	4-5
Operator unit .....	3-11, 5-13
Output data .....	1-14

## P

Parameter	
CPX module parameters .....	3-9
PROFIsafe parameters .....	3-7, 3-15
Passivation, XXVI .....	1-16
Channel-based .....	XXIV
Performance level .....	XXVI
Pictograms .....	XXIII
Process image .....	1-13
Product design .....	VIII
Product version .....	1-9
PROFIsafe .....	1-12
GSD/GSDML file .....	3-4
Process image .....	1-13
PROFIsafe address, XXVII .....	2-11
PROFIsafe parameters .....	3-7, 3-15
F_Block_ID .....	3-7
F_Check_iPar .....	3-7
F_Check_SeqNr .....	3-7
F_CRC_Length .....	3-7
F_Dest_Add .....	3-8
F_iPar_CRC .....	3-8
F_Par_Version .....	3-8
F_SIL .....	3-7
F_Source_Add .....	3-8
F_WD_Time .....	3-8
PROFIsafe status .....	4-4

## R

Reintegration .....	XXVII
Replacement .....	6-3

## S

Safety chain .....	XXVIII
Safety circuit .....	XXVIII
Achievable safety rating .....	XI
Safety classification .....	XXVIII
Safety instructions .....	VI
Safety integrity .....	XXVIII
Safety integrity level .....	XXVIII
Sensor .....	XXVIII
recommended sensors .....	1-21
Service .....	XVI
Signal indicator	
at operator unit (MMI) .....	3-12
by status LED .....	4-3, 5-6
Start-up phase .....	4-4
Status LED .....	5-8

## T

Technical data	
Ambient characteristics .....	A-7
Electrical characteristic values .....	A-5
Functional characteristic values .....	A-6
Manifold blocks .....	A-8
Safety characteristics .....	A-3
Test pulse .....	XXIX
Text symbols and markers .....	XXIII
Transport and storage conditions .....	XVI

**U**

User information ..... XXII