

# Terminal CPX

## Bus node

CPX-FB23, CPX-FB23-24

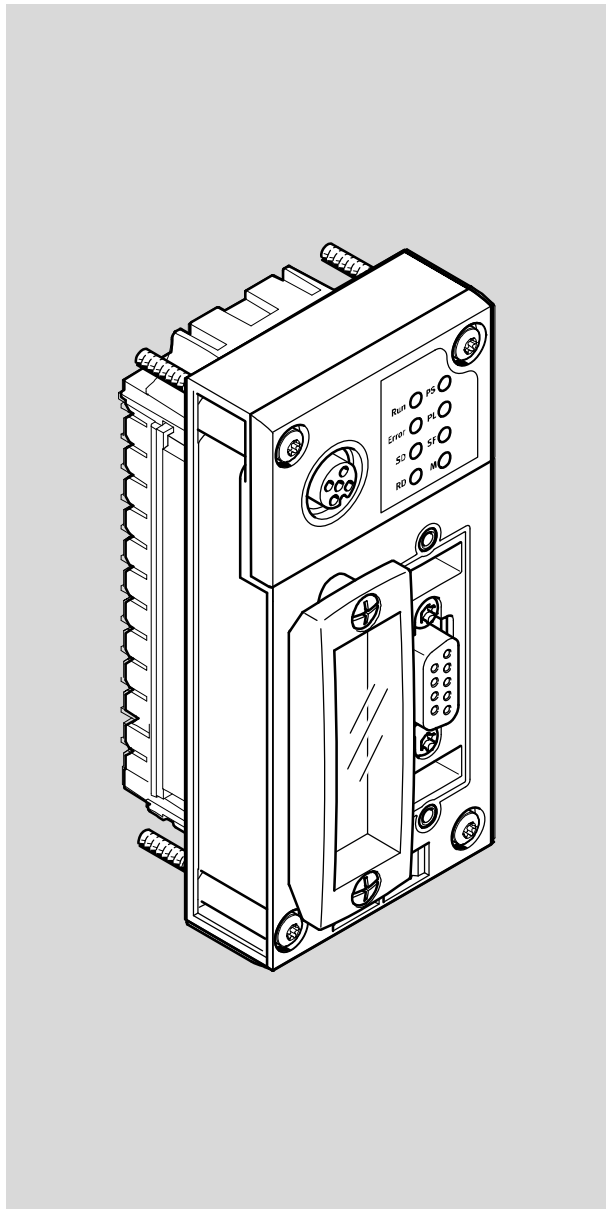

# FESTO

## Description

Fieldbus protocol  
CC-Link

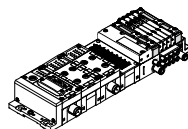

526404

1411b

[8042122]

Translation of the original instructions

P.BE-CPX-FB23-24-EN

CC-Link®, Mitsubishi® and TORX® are registered trademarks of the respective trademark owners in certain countries.

Identification of hazards and instructions on how to prevent them:



**Warning**

Hazards that can cause death or serious injuries.



**Caution**

Hazards that can cause minor injuries or serious material damage.

Other symbols:



**Note**

Material damage or loss of function.



Recommendations, tips, references to other documentation.



Essential or useful accessories.



Information on environmentally sound usage.

Text designations:

- Activities that may be carried out in any order.
- 1. Activities that should be carried out in the order stated.
- General lists.

## Table of contents – CPX-FB23, CPX-FB23-24

<b>1</b>	<b>Safety and requirements for product use</b>	<b>7</b>
1.1	Safety	7
1.1.1	General safety information	7
1.1.2	Intended use	7
1.2	Requirements for product use	8
1.2.1	Technical prerequisites	8
1.2.2	Qualification of the specialized personnel (requirements for the personnel)	9
1.2.3	Range of application and certifications	9
<b>2</b>	<b>Installation as function module F24</b>	<b>10</b>
2.1	General instructions on installation	10
2.2	Electrical connection and display components	11
2.3	Dismantling and mounting	12
2.3.1	Dismantling	12
2.3.2	Mounting	13
2.4	Settings of the DIL switches on the bus node	13
2.4.1	Removing and attaching the DIL switch cover	13
2.4.2	Arrangement of the DIL switches	14
2.4.3	Setting the DIL switches	14
2.4.4	Setting the operating mode	15
2.4.5	Setting the baud rate	16
2.4.6	Configuration as function module F24 or F23	17
2.4.7	Setting the CC-Link slave address	18
2.4.8	Setting of mapping optimisation	21
2.4.9	Setting the HOLD/CLEAR function	23
2.4.10	Setting the system diagnostics	24
2.5	Connecting the fieldbus	25
2.5.1	Fieldbus cable	25
2.5.2	Fieldbus baud rate and fieldbus length	26
2.5.3	Pin allocation of the fieldbus interface	28
2.5.4	Connecting the fieldbus	28
2.5.5	Fieldbus connection with terminating resistors	31
2.6	Pin allocation of power supply	32
<b>3</b>	<b>Commissioning as function module F24</b>	<b>33</b>
3.1	General instructions for commissioning	33
3.2	Configuration and addressing	33
3.2.1	Number of inputs/outputs	33
3.2.2	Addressing rules	35

3.2.3	Addressing examples (examples of address assignment) .....	37
3.2.4	Address assignment after extension/conversion .....	42
3.2.5	CC-Link memory mapping .....	42
3.2.6	Fieldbus configuration .....	44
3.3	Parameterisation .....	45
3.3.1	Parameters of the CPX terminal .....	46
3.3.2	Parameterisation concepts .....	47
3.4	Commissioning of the CPX terminal on the fieldbus .....	48
3.4.1	HOLD/CLEAR and Fail Safe .....	48
3.4.2	RUN/PAUSE and STOP of the master .....	48
3.4.3	RAS function .....	48
3.5	Operation as function module F24 to CC-Link master version 1.1 .....	49
<b>4</b>	<b>Diagnostics and error handling .....</b>	<b>50</b>
4.1	General instructions on diagnostics and error handling .....	50
4.2	Summary of diagnostics options .....	51
4.3	Error messages of the bus node CPX-FB23-24 .....	52
4.4	Diagnostics via LEDs .....	53
4.4.1	Standard operating status .....	54
4.4.2	CPX-specific LEDs .....	55
4.4.3	CC-Link-specific LEDs .....	57
4.4.4	Possible operating statuses of CC-Link-specific LEDs .....	58
4.5	Diagnostics via fieldbus CC-Link .....	59
4.5.1	Status bits .....	59
4.5.2	I/O diagnostics interface .....	60
<b>5</b>	<b>Function module F23 .....</b>	<b>61</b>
5.1	General instructions .....	61
5.2	Installation .....	61
5.2.1	Setting the operating mode .....	62
5.2.2	Setting the number of stations per slave / number of I/O bytes .....	63
5.3	Commissioning .....	64
5.3.1	Configuration and addressing .....	64
5.3.2	Address assignment after extension/conversion .....	72
5.3.3	CC-Link memory mapping .....	72
5.3.4	Fieldbus configuration .....	75
5.4	Parameterisation .....	75
5.5	Commissioning of the CPX terminal on the fieldbus .....	75
5.5.1	RUN/PAUSE and STOP of the master .....	76
5.6	General notes on diagnostics and error handling .....	76

<b>A</b>	<b>Technical appendix</b> .....	<b>77</b>
A.1	Technical data .....	77
A.2	Default parameterisation .....	78
A.3	Accessories .....	79
<b>B</b>	<b>Glossary</b> .....	<b>80</b>
B.1	List of abbreviations .....	80

## Notes on this documentation



### Note

This description refers to the CPX bus node type CPX-FB23 from Revision R14 (CC-Link version 1.1) and type CPX-FB23-24 from revision R22 (CC-Link version 1.1 and 2.0). For corresponding specifications, see rating plate.

This description contains specific information on installing, commissioning, programming and diagnostics with the CPX bus node for CC-Link.



The CPX bus node type CPX-FB23-24 supports either the CC-Link versions 2.0 and 1.1.

Because of the fundamental differences between protocol versions 2.0 and 1.1, the correspondingly configured bus node is either designated as a function module F24 (CC-Link version 2.0) or as a function module F23 (CC-Link version 1.1). These designations are found, for example, in the system representation of the Festo Maintenance Tools (CPX-FMT) or in the handheld terminal (CPX-MMI) from Festo.

- CC-Link version 2.0 corresponds to the function module F24 and supports up to four stations per slave with extended address space. It is possible to configure addressing to be either cycle-time-optimised or station-optimised.
- CC-Link version 1.1 corresponds to the function module F23 and supports up to four stations per slave up to an address volume of 32 bytes of inputs and outputs.



The remote controller operating mode is available only in the configuration as function module F23. The remote I/O operating mode must be set in the configuration as function module F24.

## Product identification, versions



- In **chapters 2 to 4**, the behaviour and operation of the bus nodes **CPX-FB23-24** is described **in the configuration F24**.
- The corresponding information on bus nodes is found **CPX-FB23** in the **CPX-FB23-24 configuration F23**, summarised in **chapter 5**.

General information on the fieldbus CC-Link is found in the documentation for your CC-Link master and for the relevant control systems (e.g. from Mitsubishi). An overview can be found under [www.cc-link.org](http://www.cc-link.org).

General basic information about the mode of operation, mounting, installation and commissioning of CPX terminals can be found in the CPX system description (P.BE-CPX-SYS-...).

Information about additional CPX modules can be found in the description for the respective module.

## Service

Please consult your regional Festo contact if you have any technical problems.

# 1 Safety and requirements for product use

## 1.1 Safety

### 1.1.1 General safety information

- Observe the general safety information in the corresponding chapters.



Specific safety regulations can be found immediately before the task instructions.



#### Note

##### Damage to the product from incorrect handling.

- Switch off the supply voltage before mounting and installation work. Switch on supply voltage only when mounting and installation work are completely finished.
- Never unplug or plug in a product when powered!
- Observe the handling specifications for electrostatically sensitive devices.



### 1.1.2 Intended use

The bus node documented in this description is intended as a participant on the fieldbus system Control & Communication link (CC-Link) from Mitsubishi exclusively for use in the Festo CPX terminal for installation in machines or automated systems and used as follows:

- In excellent technical condition
- In original status without unauthorised modifications, except for the adaptations described in this documentation
- Within the limits of the product defined by the technical data (→ Appendix A.1)



#### Note

In the event of damage caused by unauthorised manipulation or other than intended use, the guarantee is invalidated and the manufacturer is not liable for damages.



**Warning**

**Danger of electric shock from voltage sources without protective measures.**

- Use only PELV circuits in accordance with EN 60204-1 (Protective Extra-Low Voltage, PELV) for the electric logic supply.
- Also observe the general requirements for PELV circuits in accordance with EN 60204-1.
- Only use power sources which guarantee reliable electrical isolation of the operating voltage in accordance with EN 60204-1.

Through the use of PELV circuits, protection from electric shock (protection from direct and indirect contact) in accordance with EN 60204-1 is ensured (Electrical equipment of machines. General requirements).



In the CPX system description (P.BE-CPX-SYS-...), read the information on power supply as well as on the earthing measures to be carried out.



**Note**

In the event of damage caused by unauthorised manipulation or other than intended use, the guarantee is invalidated and the manufacturer is not liable for damages.

## 1.2 Requirements for product use

- Make this documentation available to the design engineer, installer and personnel responsible for commissioning the machine or system in which this product is used.
- Make sure that the specifications of the documentation are always complied with. Consider also the documentation for other components and modules (e.g. CPX system description P.BE-CPX-SYS-...).
- Take into consideration the legal regulations applicable for the destination, as well as:
  - Regulations and standards,
  - Regulations of the testing organizations and insurers,
  - National specifications.

### 1.2.1 Technical prerequisites

General conditions for the correct and safe use of the product, which must be observed at all times:

- Comply with the connection and environmental conditions specified in the technical data of the product (→ Appendix A.1) and of all connected components.  
Only compliance with the limit values or load limits permits operation of the product in accordance with the relevant safety regulations.
- Observe the instructions and warnings in this documentation.



### **1.2.2 Qualification of the specialized personnel (requirements for the personnel)**

This description is directed exclusively to technicians trained in control and automation technology, who are experienced in:

- Installation, commissioning, programming and diagnostics of participants in the CC-Link fieldbus system
- The applicable regulations for operating safety-engineered systems
- The applicable regulations for accident prevention and industrial safety
- The documentation for the product

### **1.2.3 Range of application and certifications**

Standards and test values, which the product complies with and fulfils, can be found in the “Technical data” section (→ Appendix A.1). The product-relevant EU directives can be found in the declaration of conformity.



Certificates and the declaration of conformity for this product are found on the Internet page of Festo (→ [www.festo.com](http://www.festo.com)).

## 2 Installation as function module F24



The instructions and descriptions for installation in this chapter with exception of section 2.4.8 are valid also for the configuration as a function module F23.

For the function module F23, section 5.2.2 is valid instead of the section 2.4.8.

### 2.1 General instructions on installation



#### Warning

- Before carrying out installation and maintenance work, switch off the following:
  - Compressed air supply
  - Operating voltage supply for the electronics/sensors
  - Load voltage supply for the outputs/valves

In this way, you can avoid

- Uncontrolled movements of loose tubing
- Accidental movements of the connected actuator technology
- Undefined switching states of the electronics



#### Caution

The CPX bus node for CC-Link contains electrostatically sensitive devices.

- Therefore, do not touch any components.
- Observe the handling specifications for electrostatically sensitive devices.

They will help you avoid damage to the electronics.



#### Note

Handle all modules and components with great care. Pay particular attention to the following:

- Comply with the specified torques



## 2.2 Electrical connection and display components

The following connection and display components are found on the CPX bus node:

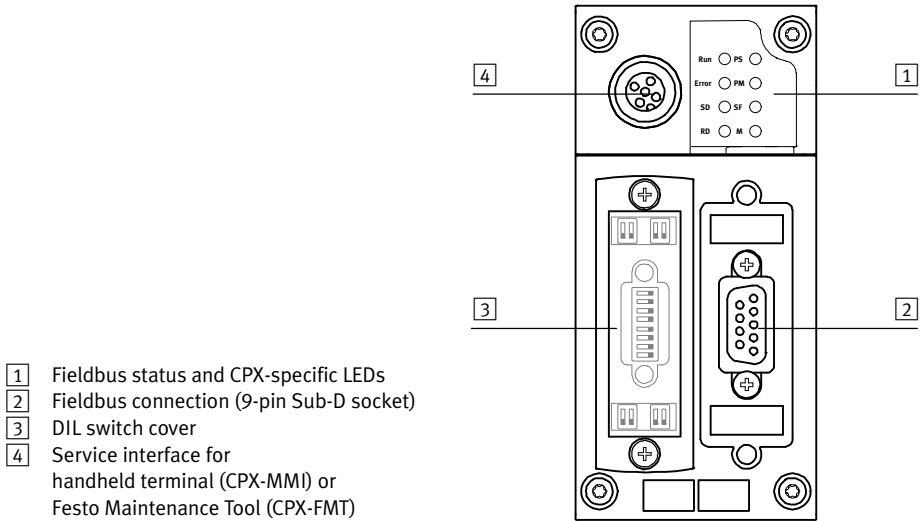

Fig. 2.1 Connection and display components on the bus node

## 2.3 Dismantling and mounting

The CPX bus node is installed on an interlinking block of the CPX terminal (→ Fig. 2.2).



### Warning

Mounting /dismounting of the bus node must always take place in a de-energised status.

- Disconnect the corresponding CPX terminal completely from the related voltage supply or switch it off.

### 2.3.1 Dismantling

Dismantle the bus node as follows:

1. Loosen the 4 screws of the bus node with a TORX® screwdriver size T10.
2. Pull the bus node carefully and without tilting away from the contact rails of the interlinking block.

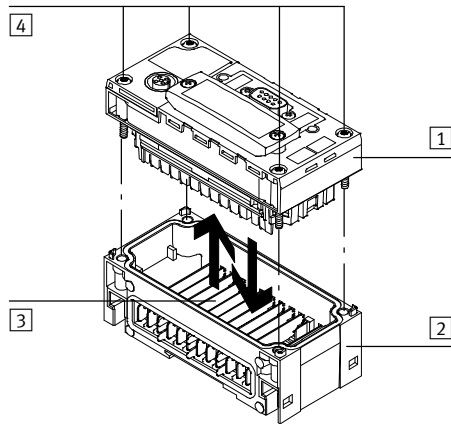

- 1 Bus node CPX-FB23-24
- 2 Interlinking block
- 3 Contact rails
- 4 Screws

Fig. 2.2 Dismantling / mounting the bus node



### Note

Always use the appropriate screws for the interlinking block (metal or plastic), dependent on the material the block is made of:

- For plastic interlinking blocks: self-tapping screws
- For metal interlinking blocks: screws with metric thread.



Both types of screws are enclosed the bus node is ordered as a single part.

### 2.3.2 Mounting

Mount the bus node as follows:

1. Check the seal and the sealing surface.
2. Place the bus node in the interlinking block. Make sure that the corresponding slots with the contacting terminals on the bottom of the bus node are above the contact rails.
3. Push the bus node carefully and without tilting into the interlinking block up to the stop.
4. Tighten the screws only by hand. Set the screws so that the self-cutting threads can be used.
5. Tighten the screws with a TORX® screwdriver size T10 with 0.9 ... 1.1 Nm torque.

## 2.4 Settings of the DIL switches on the bus node



### Note

This section describes how the DIL switch is set in the configuration of the bus node as function module F24 (support of CC-Link version 2.0).

In order to set the bus node, you must first remove the cover for the DIL switches.



### Caution

The CPX bus node for CC-Link contains electrostatically sensitive devices.

- Therefore, do not touch any components.
- Observe the handling specifications for electrostatically sensitive devices. They will help you avoid damage to the electronics.



### 2.4.1 Removing and attaching the DIL switch cover

You need a TORX® screwdriver size T10 to remove or attach the DIL switch cover.



### Note

Observe the following notes when removing or attaching the DIL switch cover:

- Disconnect the power supply before removing the DIL switch cover.
- Make sure that the seal is seated correctly when attaching the cover!
- Tighten the two fastening screws at first by hand and then with max. 0.4 Nm.

### 2.4.2 Arrangement of the DIL switches

There are 5 DIL switches available for configuring the bus node. They are located underneath the DIL switch cover (➔ Section 2.4.1).

- 1 DIL switch 1:  
– Operating mode and baud rate
- 2 DIL switch 1 and 2:  
– Baud rate
- 3 DIL switch 3:  
– Function F24/F23  
– CC-Link slave address
- 4 DIL switch 4:  
– Mapping optimisation
- 5 DIL switch 5:  
– HOLD/CLEAR  
– System diagnostics

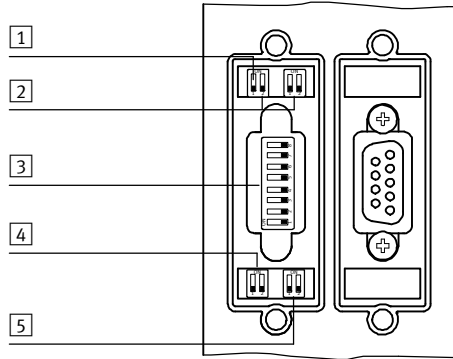

Fig. 2.3 DIL switches in the bus node CPX-FB23-24 – function module F24  
(additional information ➔ Sections 2.4.4 ... 2.4.10)

### 2.4.3 Setting the DIL switches

1. Switch off the power supply.
2. Remove the DIL switch cover (➔ Section 2.4.1).
3. Carry out the required settings (➔ Section 2.4.4 ... 2.4.10).
4. Attach the DIL switch cover again (➔ Section 2.4.1).



#### Note

Parameterisation via DIL switch settings is taken over only when the power supply is switched on.

### 2.4.4 Setting the operating mode

You set the operating mode of the bus node with switch element 1.1 of DIL switch 1.

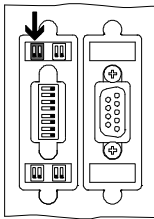

Operating mode	Setting DIL switch 1	
<p><b>Remote I/O operating mode</b> All functions of the CPX terminal are controlled directly by the higher-order PLC/IPC. The bus node undertakes the required connection to CC-Link.</p>		1.1: OFF (factory setting)
<p><b>Not possible</b> The remote controller operating mode is available only in the configuration as function module F23. <b>The remote I/O operating mode must be set in the configuration as function module F24.</b></p>		1.1: ON

Tab. 2.1 Operating mode



**Note**

The setting of the operating mode with the DIL switch has priority over all other settings.

Setting of the DIL switch 1.1 to ON causes a change to the configuration as function module F23, independent of the setting of DIL switch 3.8 (→ 2.4.6).

### 2.4.5 Setting the baud rate

You can set the baud rate with the DIL switch elements 1.2 of the DIL switch 1 and the DIL switch element 2.1 and 2.2 of the DIL switch 2.

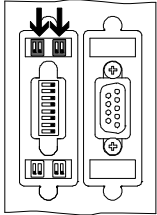

Baud rate	Setting DIL switches 1.2 and 2		
156 kBd			1.2: OFF 2.1: OFF 2.2: OFF
625 kBd			1.2: ON 2.1: OFF 2.2: OFF
2.5 MBd			1.2: OFF 2.1: ON 2.2: OFF
5 MBd			1.2: ON 2.1: ON 2.2: OFF
10 MBd			1.2: OFF 2.1: OFF 2.2: ON (factory setting)
Switch position combinations that are not presented are impermissible.			

Tab. 2.2 Baud rate



The maximum range per segment is dependent on the baud rate (➔ Section 2.5.2).

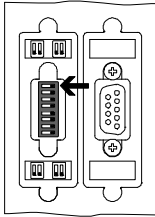

**2.4.6 Configuration as function module F24 or F23**

With the DIL DIL switch 3.8 of the DIL switch 3, the bus node can either be configured as function module F24 or as function module F23.



Function module	Setting DIL switch 3	
<b>F24:</b> Supports CC-Link version 2.0		3.8: ON (factory setting)
<b>F23:</b> Supports CC-Link version 1.1		3.8: OFF

Tab. 2.3 Function module F24 or F23



The factory setting of the DIL switch 3.8 is dependent on the order of the bus node. If the bus node is ordered as part of a CPX terminal, either the function module F24 or F23 can be selected during the configuration of the CPX terminal.

### 2.4.7 Setting the CC-Link slave address

The CC-Link slave address of the CPX terminal is set with DIL switch elements 3.1 to 3.7 of the DIL switch 3.

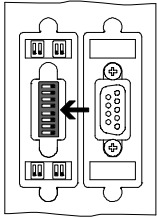

CC-Link slave address	Setting DIL switch 3	Decimal
Permitted addresses: 1 ... 64		
	3.7: $2^2 \times 10$	= 40
	3.6: $2^1 \times 10$	= 20
	3.5: $2^0 \times 10$	= 10
	3.4: $2^3$	= 8
	3.3: $2^2$	= 4
	3.2: $2^1$	= 2
Factory setting: 1	3.1: $2^0$	= 1

Tab. 2.4 CC-Link slave address



#### Note

The CC-Link slave address set here refers to the first station occupied by the CPX terminal in the fieldbus. Depending on the expansion of the CPX terminal and the resulting required stations, additional slave addresses and/or stations are automatically assigned by the CPX terminal, if necessary. CC-Link slave addresses may only be assigned once per fieldbus line.

Example: address 05	Example: address 26
$  \begin{array}{r}  + 2^2 = 4 \\  + 2^0 = 1 \\  \hline  \text{Address: } 5  \end{array}  $	$  \begin{array}{r}  + 2^1 \times 10 = 20 \\  + 2^2 = 4 \\  + 2^1 = 2 \\  \hline  \text{Address: } 26  \end{array}  $

Tab. 2.5 Examples of set addresses

On the following pages, you will find an overview of the setting the CC-Link slave addresses 1 ... 64.

Address	DIL switches							Address	DIL switches						
	3.1	3.2	3.3	3.4	3.5	3.6	3.7		3.1	3.2	3.3	3.4	3.5	3.6	3.7
1	ON	OFF	OFF	OFF	OFF	OFF	OFF	17	ON	ON	ON	OFF	ON	OFF	OFF
2	OFF	ON	OFF	OFF	OFF	OFF	OFF	18	OFF	OFF	OFF	ON	ON	OFF	OFF
3	ON	ON	OFF	OFF	OFF	OFF	OFF	19	ON	OFF	OFF	ON	ON	OFF	OFF
4	OFF	OFF	ON	OFF	OFF	OFF	OFF	20	OFF	OFF	OFF	OFF	OFF	ON	OFF
5	ON	OFF	ON	OFF	OFF	OFF	OFF	21	ON	OFF	OFF	OFF	OFF	ON	OFF
6	OFF	ON	ON	OFF	OFF	OFF	OFF	22	OFF	ON	OFF	OFF	OFF	ON	OFF
7	ON	ON	ON	OFF	OFF	OFF	OFF	23	ON	ON	OFF	OFF	OFF	ON	OFF
8	OFF	OFF	OFF	ON	OFF	OFF	OFF	24	OFF	OFF	ON	OFF	OFF	ON	OFF
9	ON	OFF	OFF	ON	OFF	OFF	OFF	25	ON	OFF	ON	OFF	OFF	ON	OFF
10	OFF	OFF	OFF	OFF	ON	OFF	OFF	26	OFF	ON	ON	OFF	OFF	ON	OFF
11	ON	OFF	OFF	OFF	ON	OFF	OFF	27	ON	ON	ON	OFF	OFF	ON	OFF
12	OFF	ON	OFF	OFF	ON	OFF	OFF	28	OFF	OFF	OFF	ON	OFF	ON	OFF
13	ON	ON	OFF	OFF	ON	OFF	OFF	29	ON	OFF	OFF	ON	OFF	ON	OFF
14	OFF	OFF	ON	OFF	ON	OFF	OFF	30	OFF	OFF	OFF	OFF	ON	ON	OFF
15	ON	OFF	ON	OFF	ON	OFF	OFF	31	ON	OFF	OFF	OFF	ON	ON	OFF
16	OFF	ON	ON	OFF	ON	OFF	OFF	32	OFF	ON	OFF	OFF	ON	ON	OFF

Switch position combinations that are not presented are impermissible.

Tab. 2.6 Setting of the addresses 33 ... 64: entry of the DIL switch

Address	DIL switches							Address	DIL switches						
	3.1	3.2	3.3	3.4	3.5	3.6	3.7		3.1	3.2	3.3	3.4	3.5	3.6	3.7
33	ON	ON	OFF	OFF	ON	ON	OFF	49	ON	OFF	OFF	ON	OFF	OFF	ON
34	OFF	OFF	ON	OFF	ON	ON	OFF	50	OFF	OFF	OFF	OFF	ON	OFF	ON
35	ON	OFF	ON	OFF	ON	ON	OFF	51	ON	OFF	OFF	OFF	ON	OFF	ON
36	OFF	ON	ON	OFF	ON	ON	OFF	52	OFF	ON	OFF	OFF	ON	OFF	ON
37	ON	ON	ON	OFF	ON	ON	OFF	53	ON	ON	OFF	OFF	ON	OFF	ON
38	OFF	OFF	OFF	ON	ON	ON	OFF	54	OFF	OFF	ON	OFF	ON	OFF	ON
39	ON	OFF	OFF	ON	ON	ON	OFF	55	ON	OFF	ON	OFF	ON	OFF	ON
40	OFF	OFF	OFF	OFF	OFF	OFF	OFF	56	OFF	ON	ON	OFF	ON	OFF	OFF
41	ON	OFF	OFF	OFF	OFF	OFF	ON	57	ON	ON	ON	OFF	ON	OFF	ON
42	OFF	ON	OFF	OFF	OFF	OFF	ON	58	OFF	OFF	OFF	ON	ON	OFF	ON
43	ON	ON	OFF	OFF	OFF	OFF	ON	59	ON	OFF	OFF	ON	ON	OFF	ON
44	OFF	OFF	ON	OFF	OFF	OFF	ON	60	OFF	OFF	OFF	OFF	OFF	ON	ON
45	ON	OFF	ON	OFF	OFF	OFF	ON	61	ON	OFF	OFF	OFF	OFF	ON	ON
46	OFF	ON	ON	OFF	OFF	OFF	ON	62	OFF	ON	OFF	OFF	OFF	ON	ON
47	ON	ON	ON	OFF	OFF	OFF	ON	63	ON	ON	OFF	OFF	OFF	ON	ON
48	OFF	OFF	OFF	ON	OFF	OFF	ON	64	OFF	OFF	ON	OFF	OFF	ON	ON

Switch position combinations that are not presented are impermissible.

Tab. 2.7 Setting of the addresses 1 ... 32: entry of the DIL switch

### 2.4.8 Setting of mapping optimisation

You set the mapping optimisation of the bus node with the DIL switch 4.2 of the DIL switch 4.

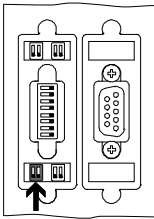

Mapping optimisation	Setting DIL switch 4	
<b>Cycle-time optimised</b> The mapping is optimised to a cycle time that is as small as possible. More stations are occupied if necessary. This setting enables also the operation on a CC-Link Master Version 1.1 as a function module F24 with a max. address space of 4 stations for single cycle time (→ Section 3.5).		4.2: OFF (factory setting)
<b>Station-optimised</b> The mapping is optimised to as few as possible assigned stations. If necessary, this extends the cycle time.		4.2: ON

Tab. 2.8 Mapping optimisation



The DIL switch 4.1 of the DIL switch 4 as a function module F24 has no function in the configuration.

#### Principle of mapping optimisation

For the mapping optimisation, the CC-Link (version 2.0) option is used to configure 4 advanced cycle settings. In addition to the standard single cycle, a 2-fold, 4-fold and 8-fold cycle are available; their use increases the cycle time correspondingly.

The number of stations required and cycles is automatically determined by the bus node according to the selected type of optimisation (cycle-time-optimised or station-optimised).

The following table shows the theoretically possible configurations for the specified useful data volume. The useful data volume in the word area relate to the setting with deactivated system diagnostics. When activated, the first word in the word area is assigned to the system diagnostics and reduces the amount of useful data by this amount.

Assigned stations	Transmitted data	Cycle setting			
		Single <sup>1)</sup>	2-fold	4-fold	8-fold
1 station	Inputs in bit area	2 bytes	2 bytes	6 bytes	14 bytes
	Outputs in bit area	2 bytes	2 bytes	6 bytes	14 bytes
	Inputs in word area	8 bytes	16 bytes	32 bytes	64 bytes
	Outputs in word area	8 bytes	16 bytes	32 bytes	64 bytes
2 stations	Inputs in bit area	6 bytes	10 bytes	22 bytes	46 bytes
	Outputs in bit area	6 bytes	10 bytes	22 bytes	46 bytes
	Inputs in word area	16 bytes	32 bytes	64 bytes	64 bytes
	Outputs in word area	16 bytes	32 bytes	64 bytes	64 bytes
3 stations	Inputs in bit area	10 bytes	18 bytes	38 bytes	64 bytes
	Outputs in bit area	10 bytes	18 bytes	38 bytes	64 bytes
	Inputs in word area	24 bytes	48 bytes	64 bytes	64 bytes
	Outputs in word area	24 bytes	48 bytes	64 bytes	64 bytes
4 stations	Inputs in bit area	14 bytes	26 bytes	54 bytes	–
	Outputs in bit area	14 bytes	26 bytes	54 bytes	–
	Inputs in word area	32 bytes	64 bytes	64 bytes	–
	Outputs in word area	32 bytes	64 bytes	64 bytes	–
		Station-optimised →			

1) Setting requires configuration of the bus node in the master as CC-Link 1.1 slave.

Tab. 2.9 Useful data volume at different cycle and station settings

The useful data volume in the bit area depicted in the table result from the maximum possible amount of data for each station multiplied by the number of set stations and cycles, minus the data needed for control of the cycles and the remote ready function.

Composition	Example 1	Example 2
Maximum possible data volume per station	4 bytes	4 bytes
× Number of set stations	× 3 stations	× 3 stations
× Number of set cycles	× 1 cycle	× 4 cycles
– 2 bytes (1 word) control data per cycle <sup>1)</sup>	– 0 × 2 bytes <sup>1)</sup>	– 4 × 2 bytes <sup>1)</sup>
– 2 bytes (1 word) remote ready	– 2 bytes	– 2 bytes
= Useful data volume	= 10 bytes	= 38 bytes

1) If more than 1 cycle, required for each cycle

Tab. 2.10 Determining the actual useful data in the bit area



**Note**

The light grey shaded values stored in Tab. 2.9 (single cycle setting) require configuration of the bus node in the master as CC-Link 1.1 slave. Otherwise, a communication error is issued.

The light grey shaded values Tab. 2.9 are also limited by the system limit of the CPX terminal (max. 64 bytes input and 64 bytes outputs).

The configuration “4 stations, 8-fold cycle setting” is not possible.



The sum of the assigned inputs in bit and word area and the sum of the assigned outputs in the bit and word area must not exceed 64 bytes, respectively. Otherwise, the CPX terminal is not ready for operation.

**2.4.9 Setting the HOLD/CLEAR function**

The CPX terminal supports the CC-Link HOLD/CLEAR function. With this, system-specific output statuses can therefore be defined in case of an error.

With the DIL switch element 5.1 of the DIL switch 5, you can set the HOLD/CLEAR function of the CPX terminal.

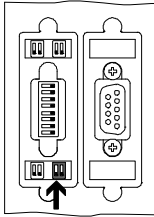

HOLD/CLEAR function	Setting DIL switch 5.1	
<p><b>CLEAR</b></p> <p>Digital outputs are reset in the event of fieldbus communication errors (→ note).</p>		<p>5.1: OFF (factory setting)</p>
<p><b>HOLD</b></p> <p>Digital outputs retain their status in the event of fieldbus communication errors.</p>		<p>5.1: ON</p>

Tab. 2.11 HOLD/CLEAR function



The following fieldbus communication errors count as error cases:

- Interruption of communication
- Timeout of communication



**Warning**

- Ensure that valves and outputs are put into a safe status if the stated malfunctions occur.

Incorrect status of valves and outputs can lead to dangerous situations.

**Note**  
 Reset of outputs means:

- Monostable valves move to the initial position
- Bistable valves remain in the current position
- Mid-position valves go into mid-position (pressurized, exhausted or closed, depending on valve type).

**Note**  
 The special CPX fail safe parameterisations (→ CPX system description P.BE-CPX-SYS-...) are not supported by the bus node CPX-FB23-24.

**2.4.10 Setting the system diagnostics**

With the DIL switch element 5.2 of the DIL switch 5, you set whether the status bits and the I/O diagnostic interface are to be available to the system diagnostics in the address range of the CPX terminal.

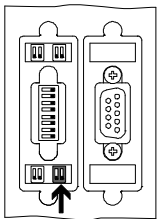

System diagnostics	Setting DIL switch 5.2	
<b>No system diagnostics</b>		5.2: OFF (factory setting)
<b>System diagnostics active</b> (→ Sections 3.2.5, 4.5 and Tab. 3.3)		5.1: ON

Tab. 2.12 System diagnostics

**Note**  
 If the system diagnostics are used with the status bits or the I/O diagnostic interface, the first word in the word area (RW<sub>r</sub> and RW<sub>w</sub>) of station 1 will be assigned for the system diagnostics.

**i** The system diagnostics are only available in the operating mode remote I/O.

Further information on the status bits and I/O diagnostic interface are found in sections 3.2 and 4.5.



## 2.5 Connecting the fieldbus

### 2.5.1 Fieldbus cable



#### Note

Faulty installation and high transmission rates may cause data transmission errors as a result of signal reflections and attenuations.

Transmission errors can be caused by:

- Missing or incorrect terminating resistor
- Incorrect screened connection
- Branches
- Transmission over long distances
- Inappropriate cables.

Observe the cable specifications! Refer to the manual for your control system for information on the type of cable to be used.



#### Note

If the valve terminal is mounted into a moving part of a machine, the fieldbus cable on the moving part must be provided with strain relief. Note the relevant regulations in IEC/EN 60204-1.



Exact details on the bus length is found in section 2.5.2 and in the manuals for your control system.

**2.5.2 Fieldbus baud rate and fieldbus length**

The maximum permitted fieldbus length depends on the baud rate used . The following table shows the usable baud rates without repeaters (CC-Link version 1.1 compatible reference cable, terminating resistor 110 Ω).

Baud rate	Cable length between stations	Max. total cable length
156 kBd	› 0.2 m (for all baud rates)	1200 m
625 kBd		900 m
2.5 MBd		400 m
5 MBd		160 m
10 MBd		100 m

<sup>1)</sup> CPX terminal with bus node CPX-FB23-24 = Remote device station

Tab. 2.13 Baud rate and fieldbus length



For setting the baud rate, observe the instructions in section 2.4.5.

### Branch lines

The following table shows the specification for branch lines (without repeater) with the CC-Link reference cable.

Topic	Specification		Comments
Baud rate	625 kBd	156 kBd	10 / 5 / 2.5 MBd not possible.
Maximum length of main string	100 m	500 m	Cable length between the terminating resistors without the length of the branch line cables.
Max. branch line length	8 m		Total cable length for a branch line.
Max. total length of branch lines	50 m	200 m	Total cable length for all branch lines.
Max. number of participants per branch line	6 participants per branch line		Total number of connectable participants depends on CC-Link specification.
Connecting cables	CC-Link reference cable		CC-Link high-performance cable cannot be used (e.g. FANC-SBH). The use of different cables is not possible.
Branch line manifold blocks	Commercially-available branch line manifold blocks		Remove as little insulation as possible from the cable when it is connected to the main string.
Branch line connectors	Recommended connectors for FA sensors: NECA4202 (IEC 947-5-2) or compatible		
Distance between branch lines	Any		Distance between branch lines (branch line manifold blocks or branch line connectors).
Length A	< 0.3 m		Cable length between remote I/Os or remote device stations.
Length B	< 1 m <sup>1)</sup> < 2 m <sup>2)</sup>		Cable length for master, local and intelligent device stations as well as the adjoining stations.

- 1) More than 1 m if only remote I/Os and remote device stations are available.
- 2) More than 2 m if local or intelligent device stations are available.

Tab. 2.14 Specification for branch lines

### 2.5.3 Pin allocation of the fieldbus interface

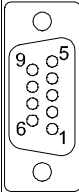
Bus connection			
Socket	Pin	CC-Link	Designation
	1	n.c.	Free (not connected)
	2	DA	Data A
	3	DG	Data reference potential (data ground)
	4	n.c.	Free (not connected)
	5	n.c.	FE via R/C comb. (not connected)
	6	n.c.	Free (not connected)
	7	DB	Data B
	8	n.c.	Free (not connected)
	9	n.c.	Free (not connected)
Housing	SLD / FG	Cable screening/shield, connection to FE of the CPX terminal	

Tab. 2.15 Pin allocation fieldbus connection

### 2.5.4 Connecting the fieldbus

#### Connection pattern

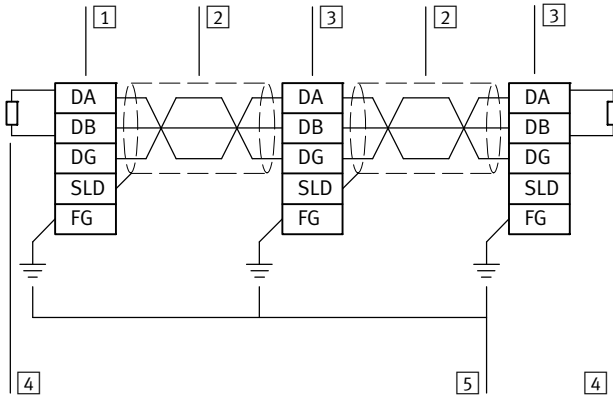

- 1 CC-Link master (master module)
- 2 Intended CC-Link cable <sup>1)</sup>
- 3 CC-Link slave (remote device station)
- 4 Terminating resistor
- 5 Earthing (SLD and FG connected in the module)

1) The three cables for connection to DA, DB and DG are twisted.

Fig. 2.4 Connection pattern of CC-Link

You can connect the CPX terminal to the fieldbus CC-Link in one of the following ways:

Manifold block/plug connector	Comments
Festo manifold block type FBA-1-KL-5POL	Protection class IP 20, connection with cable lugs
Festo Sub-D plug connector type FBS-SUB-9-GS-2X4POL-B	Degree of protection IP 65/IP 67, connection with cable clamps
Other Sub-D plug connectors	Degree of protection IP20

Tab. 2.16 Manifold block/plug connector for fieldbus connection

**→ Note**

Only the Sub-D plug connector from Festo will ensure compliance with IP 65/IP67. Before using fieldbus plugs from other manufacturers:

- Replace the two flat screws with bolts (type UNC-4-40/M3x6).

**Manifold block**

With the manifold block type FBA-1-KL-5POL, you can connect the CPX terminal to the fieldbus CC-Link. For connecting the fieldbus cable to the manifold block, use claw cable shoes similar to DIN 46225 - form B, nominal size B4-1.

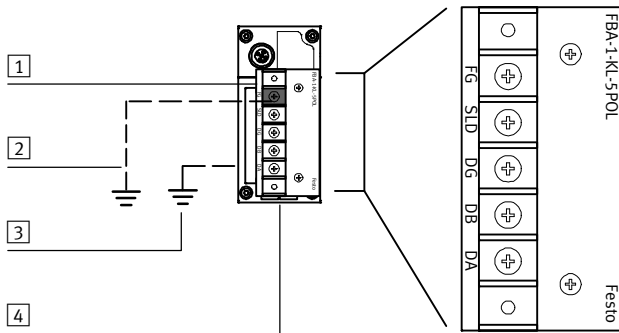

- |   |  |
|---|--|
| <p>1 Terminal block:<br/>FG (Ground)<br/>SLD (cable screening)<br/>DG (Data ground)<br/>DB (Data B)<br/>DA (Data A)</p> | <p>2 Connect FG with low impedance to FE</p> <p>3 Earthing the CPX terminal (via the earth terminal on the end plate)</p> <p>4 CPX-FB23-24</p> |
|---|--|

Fig. 2.5 Festo manifold block, pin allocation

### Sub-D plug connector

Alternatively, you can connect the CPX terminal with sub-D plug from Festo.

- Observe the mounting instructions for the fieldbus plug.
- Clamp the screening of the fieldbus cable under the clamp strap of the sub-D plug from Festo.



#### Note

The clamp strap in the fieldbus plug is connected internally with the metal housing of the sub-D plug.

Connection \*NC\* must not be connected.

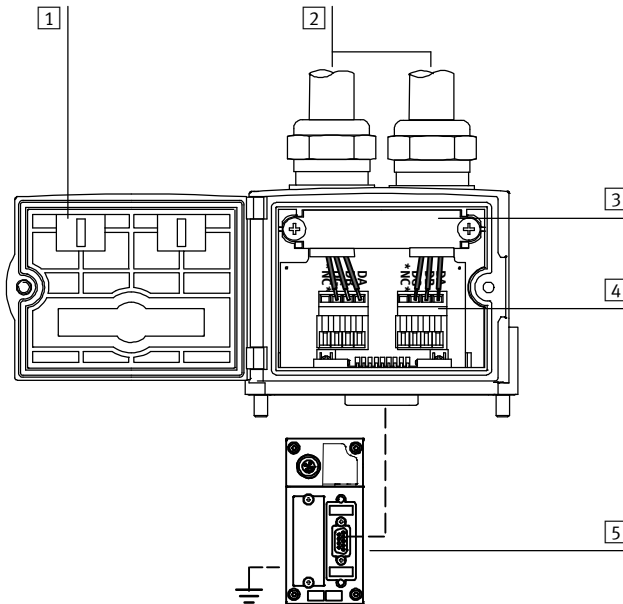

- |  |  |
|--|--|
| <p>1 Folding cover with inspection window</p> <p>2 Fieldbus cable, seal unused connection with blanking plate (IP65/IP67)</p> <p>3 Clamp strap for screened connection</p> | <p>4 Terminal strip for fieldbus incoming or continuing</p> <p>5 CPX-FB23-24 (shown at reduced size)</p> |
|--|--|

Fig. 2.6 Fieldbus plug from Festo, type FBS-SUB-9-GS-2x4POL-B



**Note**

- Note that only the Festo sub-D plug guarantees compliance with degree of protection IP65/IP67.

To comply with degree of protection IP65/IP67:

- Mount the DIL switch cover.
- Seal the service interface with the cover cap supplied.
- Use the Festo sub-D plug.

**Connecting with sub-D plug connectors of other manufacturers**

When connecting sub-D plug connectors of other manufacturers:

- Replace the two flat screws with bolts (type UNC 4-40/M3x6).
- Connect the cable screening to the plug housing.

**2.5.5 Fieldbus connection with terminating resistors**



**Note**

If the CPX terminal is at the beginning or end of the fieldbus system, a bus termination is required.

- To terminate, use a fieldbus terminal on both ends of the fieldbus segment (→ Fig. 2.4).

A resistor between Data A and Data B is used as a fieldbus termination (depending on cable type, → Tab. 2.17).

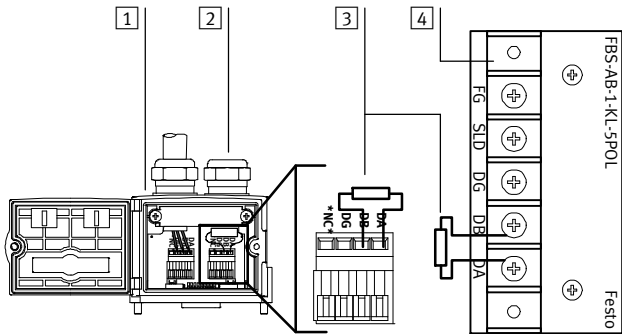

- |  |   |
|--|---|
| <p>1 Fieldbus plug from Festo</p> <p>2 Connection for continued fieldbus sealed with a blanking plug</p> | <p>3 Terminating resistor between DA and DB</p> <p>4 Festo manifold block</p> |
|--|---|

Fig. 2.7 Fieldbus connection

Cable type	Terminating resistor
FANC-110SBH, 20 AWG × 3 <sup>1)</sup>	110 Ω, 0.5 W
CC-110, CC-110-5, CS-110, CM-110-5, 20 AWG × 3 <sup>2)</sup>	
L45467-Y19-C15, 20 AWG × 3 <sup>3)</sup>	

1) KURAMO ELECTRIC Co., Ltd.

2) DYDEN Corporation

3) LEONI protec cable systems GmbH

Tab. 2.17 Fieldbus connection, cable type, terminating resistor

## 2.6 Pin allocation of power supply



### Warning

- Only use PELV circuits in accordance with IEC/EN 60204-1 (protective extra-low voltage, PELV) for the electrical power supply.
- Observe also the general requirements for PELV power circuits in accordance with IEC/EN 60204-1.
- Only use voltage sources which ensure reliable electrical isolation of the operating voltage in accordance with IEC/EN 60204-1.

Through the use of PELV circuits, protection against electric shock (protection against direct and indirect contact) is ensured in accordance with IEC/EN 60204-1.

The current consumption of a CPX terminal depends on the number and type of integrated modules and components.



In the CPX system description (P.BE-CPX-SYS-...), read the information on power supply as well as on the earthing measures to be carried out.



## 3 Commissioning as function module F24

### 3.1 General instructions for commissioning



#### Note

Before commissioning, you must have installed the CPX terminal correctly (→ Chapter 2).



General information on commissioning the CPX terminal as well as a detailed description of individual parameters is found in the CPX system description (P.BE-CPX-SYS-...).

Information on commissioning the pneumatic interface and I/O modules is found in the description for the CPX I/O modules (P.BE-CPX-EA-...).

Notes on commissioning the pneumatic components can be found in the corresponding description of pneumatics.

### 3.2 Configuration and addressing

#### 3.2.1 Number of inputs/outputs



#### Caution

For operation of the bus node CPX-FB23-24 as a function module F24 (CC-Link version 2.0), the DIL switch element 3. 8 of the DIL-switch 3 must be set on “ON” (→ Section 2.4.6).



**Note**

- The bus node automatically determines the number of inputs and outputs of the modules installed in the CPX terminal.
- Corresponding to the set mapping optimisation (cycle time or station optimised), the cycle setting and the required number of stations is automatically configured (→ Section 2.4.8).
- Depending on the required address volume of the CPX terminal, this occupies 1 or several stations (address space) in the CC-Link system (→ Section 2.4.7).
- For an activated system diagnostics function, the 1st word is assigned in the word area of station 1 (16 input and 16 output addresses). If the I/O diagnostic interface of the system diagnostics is not used, the first 8 inputs represent the status bits (→ Section 4.5.1).
- With the Festo Maintenance Tool (CPX-FMT) or handheld terminal (CPX-MMI), the configured parameters, the set CC-Link slave address and baud rate, number of occupied stations and cycle settings can be read as read-only parameters under the menu item “Module Data”.



The address assignment within the individual CPX modules is found in the description for the relevant CPX module.

Based on the CPX module type, you can ascertain the number of inputs and outputs occupied by the CPX module.

In the CPX-FMT or CPX-MMI, the individual modules are displayed with their module identifiers. In the I/O modules, the module indicator is depicted in the upper region of the module next to the LEDs (for example, 8DI for a module with 8 digital inputs).



Detailed information on the electric and pneumatic CPX modules are found in the Festo Support Portal (→ [www.festo.com](http://www.festo.com)).

### 3.2.2 Addressing rules

#### I/O counting mode

- The address assignment of the inputs is independent of the address assignment of the outputs.
- The counting mode is independent of the position of the bus node in the CPX terminal.
- Counting mode from left to right, corresponding to the installation position in the CPX terminal and dependent on the module type.
- Digital I/Os, analogue I/Os and I/Os of technology modules occupy their address volume, ascending respectively without gaps in the corresponding address space.
- Digital I/Os are mapped in the bit area; analogue I/O and I/O technology modules are mapped parallel in the word area, starting from the 1st station to be mapped.
- Remote ready (RR, CC-Link-specifically reserved) is always in the bit area at the end in the last occupied station or last used cycle (→ Fig. 3.1 and Fig. 3.2).
- The status bits and the I/O diagnostic interface of the system diagnostics occupy, if activated, the first 2 bytes of the inputs and outputs of the word area of the 1st station (→ e.g. Fig. 3.1).

Address assignment (address type)		Area	Addressing rules
1	Remote ready (RR)	Bit area	<ul style="list-style-type: none"> <li>– The last 16 inputs and outputs (2 byte each) in the bit area (RX, RY) of the last assigned station are CC-Link-specifically reserved.</li> </ul>
2	System diagnostics (status bits and I/O diagnostic interface) <sup>1)</sup>	Word area	<ul style="list-style-type: none"> <li>– The system diagnostics occupies the first 16 inputs and outputs (2 byte each) in the word area (RW<sub>r</sub>, RW<sub>w</sub>) of station 1. <sup>1)</sup></li> </ul>
3	Digital I/O modules, e.g.: <ul style="list-style-type: none"> <li>– CPX-4DE</li> <li>– CPX-8DE</li> <li>– CPX-4DA</li> <li>– CPX-8DE-8DA</li> </ul> or Pneumatic interfaces, e.g.: <ul style="list-style-type: none"> <li>– CPX-VMPA-...</li> <li>– CPX-VPMPA-FB-...</li> </ul> or Pneumatic modules, e.g.: <ul style="list-style-type: none"> <li>– VMPA1S-D... <sup>2)</sup></li> <li>– VMPA2S-D... <sup>2)</sup></li> </ul>	Bit area	<ul style="list-style-type: none"> <li>– Addresses are occupied in the free address space of the bit area (RX / RY) corresponding to the set mapping optimisation (cycle time or station optimised).</li> <li>– Arrangement corresponding to the installation position in the CPX terminal (from left to right) beyond the cycles and/or station limits (ascending without gaps).</li> </ul>
4	Analogue modules, e.g.: <ul style="list-style-type: none"> <li>– CPX-2AE-...</li> <li>– CPX-2AA-...</li> </ul>	Word area	<ul style="list-style-type: none"> <li>– Addresses are occupied in the free address space of the word area (RW<sub>r</sub>/RW<sub>w</sub>) corresponding to the set mapping optimisation (cycle-time- or station-optimised).</li> <li>– Addresses are assigned in the respective address space parallel to digital I/O and pneumatic modules.</li> <li>– Arrangement dependent on the installation position in the CPX terminal (from left to right).</li> </ul>
5	Technology modules, e.g.: <ul style="list-style-type: none"> <li>– CPX-FEC</li> <li>– CPX-CEC-...</li> <li>– CPX-CTEL-...</li> <li>– CPX-CMAX-C1-2</li> </ul>		

1) Only with activated system diagnostics

2) Type of electronic module included.

Tab. 3.1 I/O counting mode: addressing rules for the CPX modules

### 3.2.3 Addressing examples (examples of address assignment)

#### General example

The following representations show the address allocation of the inputs and outputs with enabled system diagnostics, different mapping optimisation (cycle-time-optimised or station-optimised) and with identical configuration of the CPX terminal:

16 DI, 24 DO, 10 AI, 8 AO.

#### Mapping optimisation: cycle-time-optimised

The following configuration arises from the address volume of the CPX terminal:  
3 stations, single cycle time.

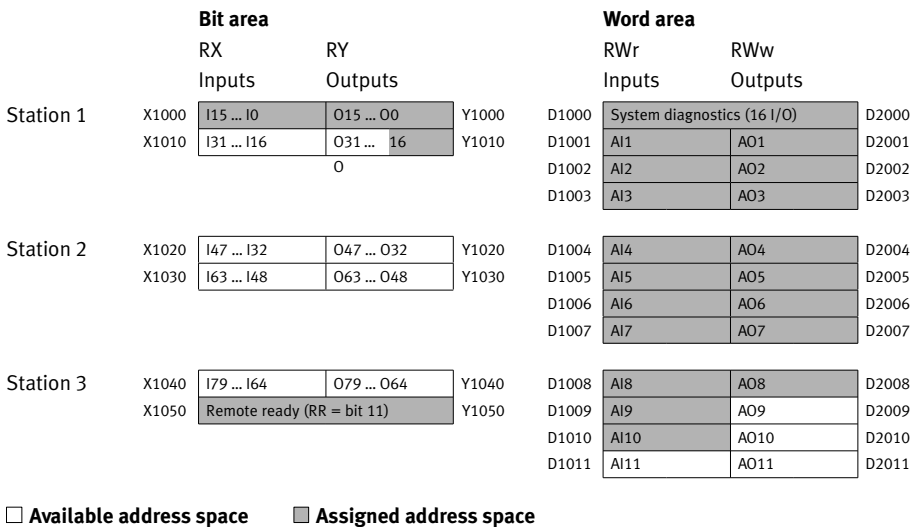

Fig. 3.1 Example for cycle-time-optimised CC-Link memory mapping

**Mapping optimisation: station-optimised**

The following configuration arises from the address volume of the CPX terminal:

1 station, 4-fold time.

- The 3rd cycle contains user data in the word area
- The 4th cycle contains no user data
- Remote ready situated at the end of the 2nd cycle

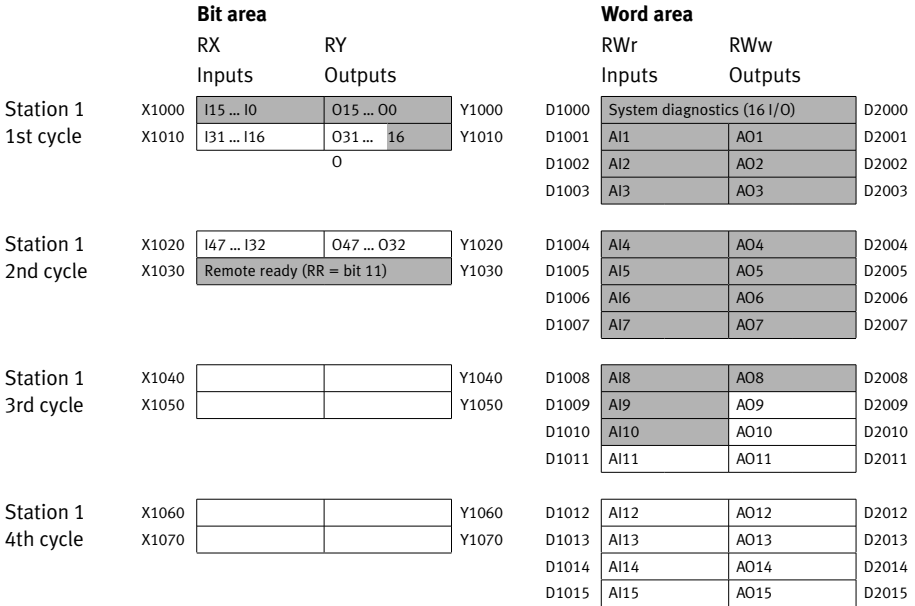

Available address space     Assigned address space

Fig. 3.2 Example for station optimised CC-Link memory mapping

### Configuration example

The following example describes a specific configuration of a CPX terminal with digital and analog I/O modules and MPA pneumatics, and the resulting allocation of I/O data, depending on the selected mapping optimisation.

### Configuration of the CPX terminal

Mod. No.	Electric modules	Module identifier <sup>1)</sup>	Assigned addresses			
			RX	RY	RWr	RWw
0	Bus node FB23-24 (F24) with system diagnostics	FB24-RIO	2 byte <sup>2)</sup>	2 byte <sup>2)</sup>	2 byte <sup>3)</sup> (1 word)	2 byte <sup>3)</sup> (1 word)
1	Digital 8-fold input and 8-fold output module	8DI/8DO	1 byte	1 byte	–	–
2	Analogue 4-fold input module	4AI	–	–	8 bytes (4 words)	–
3	Digital 8-fold input module	8DI	1 byte	–	–	–
4	Analogue 2-fold output module	2AO	–	–	–	4 bytes (2 words)
5	Analogue 4-fold input module	4AI	–	–	8 bytes (4 words)	–
6	MPA pneumatic module (type 32) with galvanic isolation	MPA1S	–	1 byte	–	–
	Sum of the respective address ranges		4 bytes	4 bytes	18 bytes (9 words)	6 bytes (3 words)

- 1) Module identifiers on the Festo Maintenance Tool (CPX-FMT) or handheld terminal (CPX-MMI), for I/O modules these are shown in the inspection window of the module.
- 2) Remote ready bit always occupies the address space of 2 bytes in the bit area (RX, RY) at the end of the last station with 1 bit.
- 3) The system diagnostics (status bits and I/O diagnostic interface) occupies 16 I/Os (the first word) in the word area of the first station (RWr, RWw).

Tab. 3.2 Configuration example for the CPX terminal depicted in Fig. 3.3 and Fig. 3.4

### Cycle-time-optimised assignment of I/O data

The following configuration arises from the address volume of the CPX terminal:

3 stations, single cycle time.

The figure (→ Fig. 3.3) shows the distribution of module-specific I/O data in the CC-Link specific address ranges, and the arrangement and sequence of I/O data within these address ranges.

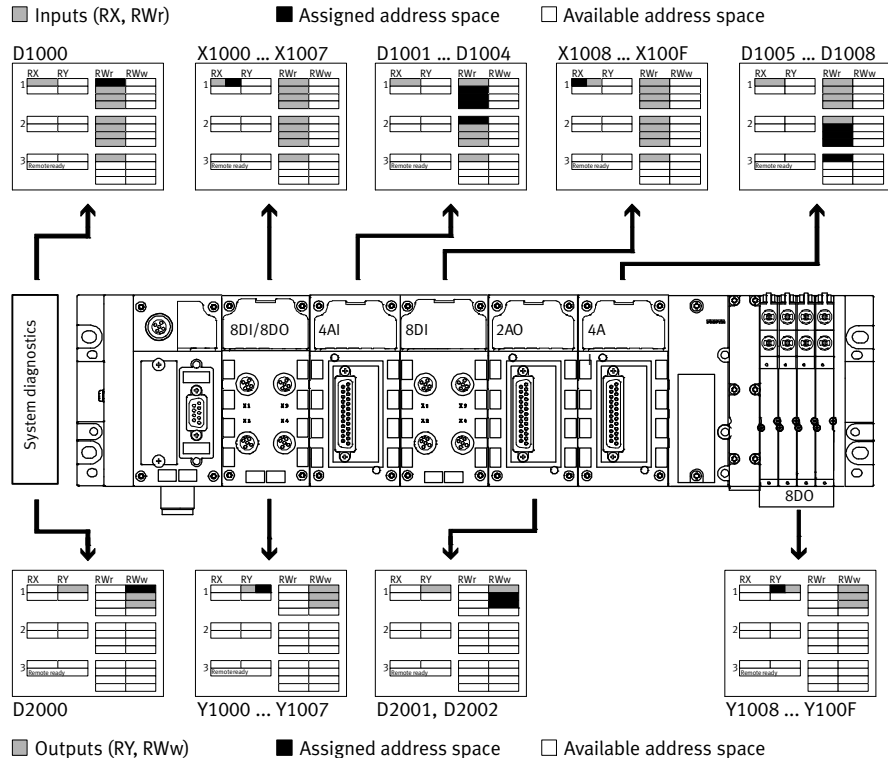

X1000, Y1000, D1000, D2000... Exemplary representation of the CC-Link address assignment (hexadecimal)

Fig. 3.3 Cycle-time-optimized addressing of the CPX terminal described in Tab. 3.2



**Station-optimised assignment of I/O data**

The following configuration arises from the address volume of the CPX terminal:  
 1 Station, 4-fold cycle time.

The Figure (→ Fig. 3.4) shows the distribution of module-specific I/O data in the CC-Link-specific address ranges and the arrangement and sequence of I/O data within these address ranges.

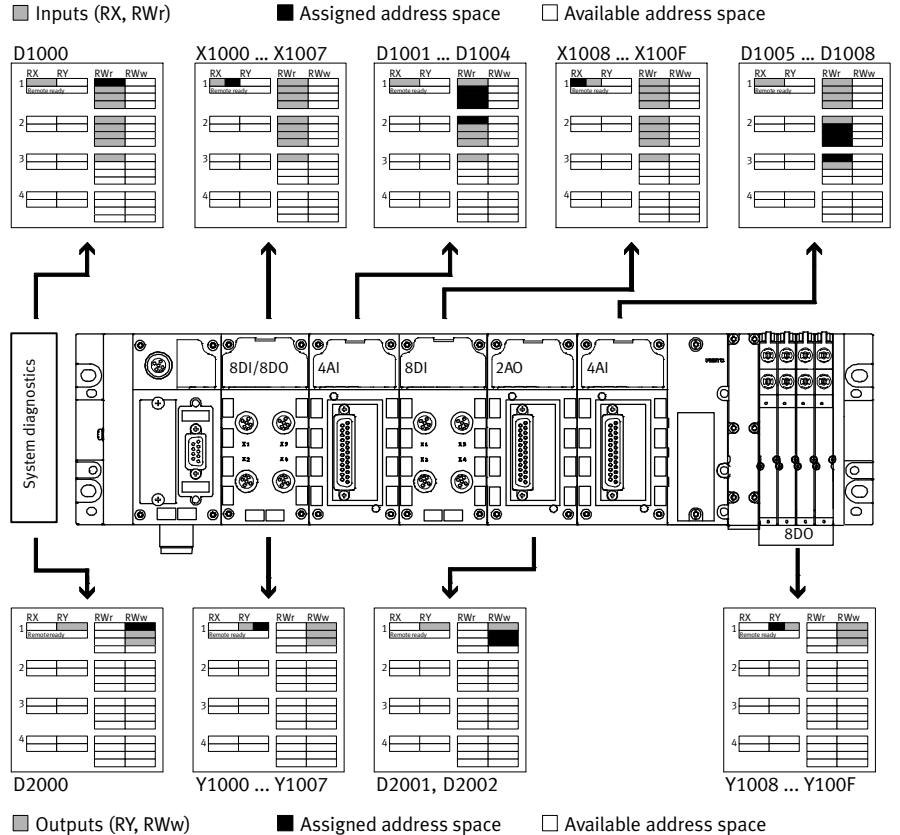

X1000, Y1000, D1000, D2000... Exemplary representation of the CC-Link address assignment (hexadecimal)

Fig. 3.4 Station-optimized addressing of the CPX terminal described in Tab. 3.2

### 3.2.4 Address assignment after extension/conversion

If there is a change in the machine requirements, the CPX terminal can be adapted as required due to its modular design.



#### Caution

If the CPX terminal is extended or converted at a later stage, input/output addresses may be shifted. This applies in the following cases:

- Additional modules are inserted between existing modules.
- Existing modules are removed or replaced by other modules, which have fewer or more input/output addresses.
- Interlinking blocks and/or pneumatic manifold blocks for monostable valves are replaced by interlinking blocks/manifold blocks for bistable valves or vice versa (→ Pneumatics description).
- Additional interlinking blocks and/or manifold blocks are inserted between existing ones.
- The configured addresses of the pneumatic interface are modified.

If the configuration of a CPX terminal has been changed, the necessary, new requirements for the CPX terminal must be checked and the mapping optimisation set accordingly:

- Cycle-time-optimised, when a fast response time of the CPX terminal is required.
- Station-optimised, when a larger address space of the CPX terminal is required.



Moreover, it should be noted that the needed address space may increase due to modification of the CPX terminal, and so the slave addresses of the following slaves in the field-bus must be checked and adjusted if necessary.

### 3.2.5 CC-Link memory mapping

#### Digital inputs and outputs (I/Os)

Digital I/Os occupy successively their corresponding address volume in the free address space of the bit area (RX/RY) corresponding to the set mapping optimisation, cycle-time- or station-optimised (→ Section 3.2.3).

#### Analogue inputs and outputs

Analogue I/Os occupy successively their corresponding address volume in the free address space of the word area (RWr/RWw) corresponding to the set mapping optimisation, cycle-time- or station-optimised (→ Section 3.2.3).

#### Remote ready (RR, CC-Link-specific)

The remote ready bit is set to “1” by the bus node after successful initialization.

At each cycle-time optimisation, the last 2 bytes in the bit area (RX and RY) of the last station are reserved (→ Fig. 3.1).

For station optimisation, the last 2 bytes in the bit area (RX and RY) of the immediately following free cycle address space are reserved (→ Fig. 3.2).

Bit 11 of the input section (RX) includes the remote ready bit.

### System diagnostics

The status bits and the I/O diagnostic interface of the system diagnostics occupy, if activated, the first 2 bytes, respectively, of the inputs and outputs of the word area of the 1st station (→ e.g. Fig. 3.1).

The following table shows the assignment of the word area of the first station with an activated system diagnostics.

<b>System diagnostics (→ CPX system description)</b>																
<b>Slave &gt; Master – RWw(n)0<sup>1)</sup></b>																
Bit:	15	14	13	12	11	10	9	8	7	6	5	4	3	2	1	0
Signal:	Q <sup>2)</sup>	Reserved							Diagnostics data When the control signal returns 0, the bits 0 ... 7 represents the status bit (→ Section 4.5.1)							
<b>Master &gt; Slave – RWw(n)0<sup>1)</sup></b>																
Bit:	15	14	13	12	11	10	9	8	7	6	5	4	3	2	1	0
Signal:	S <sup>2)</sup>	Reserved		Function number												

1) n = assigned CC-Link slave address

2) Q = quitting bit; S = control bit

Tab. 3.3 System diagnostics: status bits and I/O diagnostics interface



Detailed information on system diagnostics is found in the CPX system description (P.BE-CPX-SYS-...).

### 3.2.6 Fieldbus configuration

Before a slave can be connected (e.g. bus node CPX-FB23-24) to the CC-Link master, various configuration settings must be made, e.g.:

- Number of connected slaves
- Number of stations to be connected to the system again during a scanning cycle
- Status if there is a CPU fault in the main computer
- Station data (settings of the slave):
  - Station type (CPX-FB23-24: Remote device station)
  - CC-Link slave address (1 ... 64)
  - Function module F24
  - Protocol version CC-Link version 2.0 or 1.1 (→ Note)
  - Optimisation type: cycle-time- or station-optimised

The configuration settings are saved in the master station buffer memory. The settings can, for example, be set as follows (in some cases dependent on the master):

- With the GX Developer
- Through manual programming using PLC code



General information on the fieldbus CC-Link is found in the documentation for your CC-Link master and for the relevant control systems (e.g. from Mitsubishi).  
An overview can be found under [www.cc-link.org](http://www.cc-link.org).



#### Note

In a configuration with single cycle setting (→ Tab. 2.9) the bus node in the master must be configured as CC-Link 1.1 slave.

### 3.3 Parameterisation

Parameterisation of the CPX-Terminal with the bus node CPX-FB23-24 is possible with universal handheld terminal (CPX-MMI) and also the PC software Festo Maintenance Tool (CPX-FMT) (→ Tab. 3.4).



General information regarding operation of the handheld terminal and commissioning of the CPX terminal with the handheld terminal is found in the description of handheld terminal.



The current version of the PC software CPX Festo Maintenance Tool (CPX-FMT) is found on the Internet page of Festo (→ [www.festo.com](http://www.festo.com)).

For the operation of the PC software (CPX-FMT) on the bus node, you need the USB adapter (connecting cable), type NEFC-M12G5-0.3-U1G5.



#### **Warning**

The connected actuators can move unexpectedly!

Modification of the signal statuses and parameters with the MMI or CPX-FMT can trigger dangerous movements of the connected actuators.

- Make sure that nobody is in the positioning range of connected actuators, and be very careful with the parameterisation or manipulation of signal statuses.
- It is imperative that you observe the notes on “Force”, “Idle mode” and “Fail safe” in the CPX system description (P.BE-CPX-SYS-...), in the description of the CPX-MMI and in the online help of the CPX-FMT.

### 3.3.1 Parameters of the CPX terminal

You can set the behaviour of the CPX terminal as well as the behaviour of individual modules and channels through parameterisation. A distinction is made between the following parameterisation types:

- System parameterisation, e.g. deactivating error messages etc.
- Module parameterisation (module- and channel-specific), e.g.: monitoring, settings in case of error, settings for Forcing.



A description and function of individual parameters are found in the CPX system description (P.BE-CPX-SYS-...).

Which module parameters are available for various CPX modules are found in the description for the respective CPX module.

#### “System start” parameter

The “System start” parameter allows you to set and determine the starting behaviour of the CPX terminal.



As setting, select if possible “System start with saved parameterisation and CPX expansion”.

With this setting, all parameters and the current expansion of the CPX terminal are stored in the bus node.

If individual modules of the CPX terminal in the service case are replaced, the set parameters are still valid and no new parameterisation needs to be carried out. A system start with the setting “System start with saved parameterisation and saved CPX expansion” can take place.

The M-LED (Modify LED) lights up only for the setting “System start with saved parameterisation and CPX expansion”.



#### Caution

In case of a defect and replacement, saved settings are also lost. Therefore, the parameterisation should be kept in the CPX-MMI or via CPX-FMT on a PC. It can be transferred to the replacement bus node. Notes are found in the descriptions of CPX-MMI and CPX-FMT.



If the CPX terminal is extended or modified (for example, another module is integrated), the system start must occur with the setting “System start with default parameters and the current CPX expansion”.

Subsequently, the startup parameters should be reset to “System start with saved parameterisation and saved CPX expansion”, and the CPX terminal will now be reconfigured as needed.

### 3.3.2 Parameterisation concepts

The following table includes an overview of the options for parameterisation of the CPX terminal as well as their advantages and disadvantages.

Method	Description	Advantages	Disadvantages
Handheld terminal (CPX-MMI)	Parameterisation is carried out via menu-guided entries with the handheld terminal.	<ul style="list-style-type: none"> <li>– Convenient parameterisation via the menu navigation (clear text).</li> <li>– Parameterisation can be saved in the handheld terminal.</li> </ul>	<ul style="list-style-type: none"> <li>– Access via remote maintenance is not possible.</li> </ul>
Festo Maintenance Tool (CPX-FMT)	Parameterisation via PC software.	<ul style="list-style-type: none"> <li>– Very convenient parameterisation via PC software with supporting functions</li> <li>– Parameterisation can be saved on the PC.</li> <li>– Remote maintenance via Ethernet possible <sup>1)</sup>.</li> </ul>	<ul style="list-style-type: none"> <li>– PC with connection to the bus node is necessary (via USB <sup>2)</sup> or Ethernet <sup>1)</sup>).</li> </ul>
I/O diagnostics interface	Read-only access to the current parameters and data (➔ CPX system description).	<ul style="list-style-type: none"> <li>– The current parameter setting can be checked through the master.</li> </ul>	<ul style="list-style-type: none"> <li>– The parameters cannot be modified.</li> <li>– Complex programming.</li> </ul>

1) Front end controller (FEC and/or CEC) in CPX terminal required

2) USB adapter (connecting cable), type NEFC-M12G5-0.3-U1G5 (➔ [www.festo.com](http://www.festo.com))

Tab. 3.4 Parameterisation

### 3.4 Commissioning of the CPX terminal on the fieldbus

In order to avoid errors (e.g. configuration and parameterisation errors) during commissioning:

- Observe general commissioning instructions in the CPX system description (P.BE-CPX-SYS-...).
- Check the DIL switch settings before using and replacing CPX terminals.
- Check the address assignment of the I/Os on the CPX terminal.
- Check the configured address range and test the I/Os, if necessary.

#### 3.4.1 HOLD/CLEAR and Fail Safe

The CPX terminal supports the CC-Link function HOLD/CLEAR. System-specific states of the digital outputs can therefore be defined in the event of an error.

The reaction of digital outputs in case there is a fault is defined with the relevant DIL switch setting (→ Section 2.4.9).

#### 3.4.2 RUN/PAUSE and STOP of the master

In the STOP mode of the CC-Link master (e.g. by interruption of communication), the status of the digital outputs in bit-field (RY) is dependent on the DIL switch setting HOLD/CLEAR.

The following table shows the behaviour according to CC-Link specifications:

CC-Link master status	DIL switch setting	
	CLEAR	HOLD
RUN/PAUSE	Normal operation (refresh)	
STOP	The digital outputs (RY) are reset (value: 0).	The digital outputs (RY) retain their status.

Tab. 3.5 RUN/PAUSE and STOP of the master



#### Note

Analogue outputs (RWw) always keep their status regardless of the set HOLD/CLEAR function .

#### 3.4.3 RAS function

The CPX terminal supports the RAS functions (Reliability, Availability, Serviceability) of the fieldbus CC-Link.

##### Functions for separating from slave stations

- Even if a decentralised or local station fails (e.g. voltage drop), the network operation will not be impaired.
- A defective slave station can be replaced while the network is in operation (the voltage of the station to be replaced must be switched off).
- When a station is linked into the system again after a fault has been eliminated, it is not necessary to reset the master station.

##### Monitoring the communication status

- The network can be monitored by the master station during system set-up, debugging or maintenance.



### 3.5 Operation as function module F24 to CC-Link master version 1.1

For single cycle-time setting, the bus node uses the CC-Link version 1.1 to communicate with the master.

This allows the bus node to be operated, even in the configuration, as a function module F24 to a master which only supports CC-Link version 1.1.

Due to efficient use of the address space in the configuration as a function module F24 it may thus be possible to achieve greater expansion of the CPX terminal to a CC-Link master version 1.1 than in the configuration as a function module F23 (→ Examples in section 3.2.3 and 5.3.1).

In addition, the bus node automatically determines the number of stations required.

For the address volume of the CPX terminal, the following conditions apply:

- For cycle-time-optimised mapping, the address volume of the CPX terminal, the address space of 4 stations for single cycle time may not be exceeded (→ Section 2.4.8).
- For station-optimised mapping, the address volume of the CPX terminal, the address space of 1 station for single cycle time may not be exceeded (→ Section 2.4.8).



#### Note

If through conversion or extension of the CPX terminal, the address space supported by the CC-Link version 1.1 is exceeded, the bus node changes to CC-Link version 2.0. Communication with a V1.1 control is no longer possible.

## 4 Diagnostics and error handling

### 4.1 General instructions on diagnostics and error handling



The CPX terminal provides you with extensive and user-friendly possibilities for diagnostics and error handling (→ Tab. 4.1).



Additional information on general diagnostics of the CPX terminal is found in the CPX system description (P.BE-CPX-SYS-...). Information on diagnostics of the pneumatics, of the pneumatic interface and of the I/O module are found in the corresponding descriptions.

## 4.2 Summary of diagnostics options

Depending on its configuration, the bus node CPX-FB23-24 supports various options for diagnostics and error handling.

<b>Diagnostics option</b>	<b>Brief description</b>	<b>Advantages</b>	<b>Detailed description</b>
LED indicator	LEDs show configuration errors, hardware faults, bus errors, etc. directly.	Rapid detection of errors “on-site”.	➔ Section 4.4
Status bits	Internal inputs that supply coded common diagnostic messages. The 8 status bits are transmitted to the interface as “inputs” cyclically with the normal inputs.	Fast access to error messages, independent of the module and master.	➔ Section 4.5.1 and CPX system description
I/O diagnostics interface	The I/O diagnostics interface is a fieldbus-independent diagnostics interface at I/O level, which permits access to internal data of the CPX terminal (16 inputs and 16 outputs).	Detailed error detection: the diagnostics data can be processed further, e.g. by a PLC user program	➔ Section 4.5.2 and CPX system description
Diagnostics via the handheld terminal (CPX-MMI)	Diagnostic information can be shown on the CPX-MMI in a user-friendly and menu-driven manner.	Fast “on-the-spot” error detection	➔ Description of the CPX-MMI
Diagnostics via the Festo Maintenance Tool (CPX-FMT)	The CPX-FMT offers the option to display diagnostic information on a PC.	Fast “on-site” error detection. Diagnostics also possible from a higher automation level.	➔ Online help for the CPX-FMT

Tab. 4.1 Diagnostics options



### Note

Note that the diagnostic information is dependent on the DIL switch settings on the bus node, (➔ Section 2.4.10) as well as on the parameterisation of the CPX terminal.

### 4.3 Error messages of the bus node CPX-FB23-24

In addition to the CPX-specific fault messages (→ CPX system description, P.BE-CPX-SYS-...) the bus node can CPX-FB23-24 report the following special errors:

Error number	Error class	Operating status	Error correction
71	2	Fieldbus connection lost during operation (timeout or no transmission)	Check the fieldbus connection.
70	2	Only function module F23: Set number of stations too small	Check the expansion of the CPX terminal and the number of stations required and, if necessary, increase the number of stations per slave by means of the DIL switch (→ Section 5.2.2).

Tab. 4.2 Error numbers bus node CPX-FB23-24



If the system boundary of the CPX terminal is exceeded by complex expansion of the maximum possible address space, commissioning of the CPX terminal is not possible. The error will be displayed on the bus node of the “SF LED”.

## 4.4 Diagnostics via LEDs

LEDs for the diagnostics of the CPX terminal are available on the bus node as well as on the individual modules.



The meaning of the LEDs on the electric modules can be found in the description for the relevant module.

### LEDs at the bus node CPX-FB23-24

The LEDs on the cover indicate the operating status of the CPX bus node.

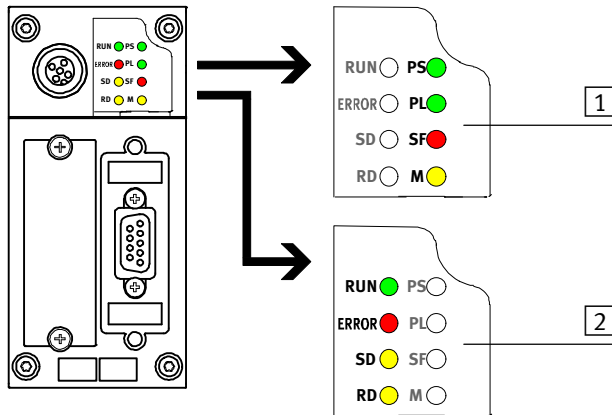

**1** CPX-specific LEDs:

- PS (green)
- PL (green)
- SF (red) \*)
- M (yellow)

**2** CC-Link-specific LEDs:

- RUN (green)
- ERROR (red)
- SD (yellow)
- RD (yellow)

\*) The SF LED also shows CC-Link-specific faults

Fig. 4.1 LEDs on the CPX bus node CPX-FB23-24

In this chapter, the LEDs are depicted in their various statuses as follows:





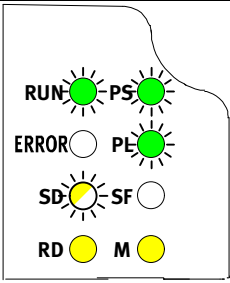

 is illuminated;  flashes;  off

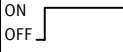

#### 4.4.1 Standard operating status



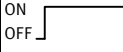

In the standard operating status, all green LEDs are illuminated. The yellow LEDs light up or flash. The red LEDs do not light up.

LED indicator		Operating status
	<p>All green LEDs light up:</p> <ul style="list-style-type: none"> <li>- RUN</li> <li>- PS</li> <li>- PL</li> </ul> <p>The red LEDs do not light up:</p> <ul style="list-style-type: none"> <li>- ERROR</li> <li>- SF</li> </ul> <p>Yellow LEDs light up or flash (depending on the data communication or configuration)</p> <ul style="list-style-type: none"> <li>- SD</li> <li>- RD</li> <li>- M</li> </ul>	<p>Standard</p>

4.4.2 CPX-specific LEDs

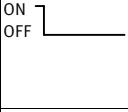
PS (power system) – power sensor/logic supply			
LED (green)	Process	Status	Significance/error handling
 LED illuminated	ON OFF 	No error. Operating voltage/sensor supply applied	–
 LED flashing	ON OFF 	Operating voltage/sensor supply outside the tolerance range	<ul style="list-style-type: none"> <li>• Eliminate undervoltage</li> </ul>
	ON OFF 	Internal fuse for the operating voltage/sensor supply has responded	<ol style="list-style-type: none"> <li>1. Eliminate short circuit/overload on module side</li> <li>2. Depends on the parameterisation of the module (module parameter):                             <ul style="list-style-type: none"> <li>– The sensor supply voltage will be switched on again automatically after the short circuit has been eliminated (default)</li> <li>– Power OFF/ON required</li> </ul> </li> </ol>
 LED is not illuminated	ON OFF 	The operating voltage/sensor supply is not applied	<ul style="list-style-type: none"> <li>• Check the operating voltage connection of the electronics</li> </ul>

PL (power load) – power load supply (outputs/valves)			
LED (green)	Process	Status	Significance/error handling
 LED illuminated	ON OFF 	No error. Load voltage applied	–
 LED flashing	ON OFF 	Load voltage at the system supply or additional power supply outside the tolerance range	<ul style="list-style-type: none"> <li>• Eliminate undervoltage</li> </ul>





<b>SF (system failure) – system fault</b>			
<b>LED (green)</b>	<b>Process <sup>1)</sup></b>	<b>Status</b>	<b>Significance/error handling</b>
 LED not illuminated		No error	–
 LED flashing		Simple error/information (error class 1)	➔ Description of error numbers in the CPX system description
		Error (error class 2)	➔ Description of error numbers in the CPX system description ➔ Specific errors bus nodes CPX-FB23-24, section 4.3
		Serious error (error class 3)	➔ Description of error numbers in the CPX system description

1) The system fault LED flashes depending on the class of fault which has occurred.

Error class 1 (slight error): 1× flash, pause time

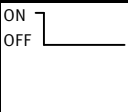
Error class 2 (error): 2× flashes, pause time

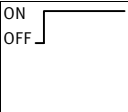



Error class 3 (severe error): 3× flashes, pause time







<b>M (modify) – parameterisation modified or Force active</b>			
<b>LED (yellow)</b>	<b>Process</b>	<b>Status</b>	<b>Significance/error handling</b>
 LED not illuminated		System start with default parameterisation (factory setting) and current CPX expansion set; external parameterisation is possible (presetting)	–
 LED illuminated		System start with saved parameterisation and saved CPX expansion has been set; Parameters and CPX expansion are stored permanently	For replacement of the bus node, or of the CPX terminal in the service case, parameterisation is not created automatically by the higher-order system (PLC/IPC). <ul style="list-style-type: none"> <li>• Save and apply the parameterisation for a replacement of the bus node.</li> </ul>
 LED flashing		Force is active <sup>1)</sup>	The Force function is enabled.





1) The display of the Force function (LED flashing) has priority over the display of the setting for the system start (LED illuminated).





**4.4.3 CC-Link-specific LEDs**





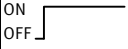







































<b>RUN – data communication OK</b>			
<b>LED (green)</b>	<b>Process</b>	<b>Status</b>	<b>Significance/error handling</b>
 LED illuminated	ON  OFF	No error. Data communication OK	→ Section 4.4.4
 LED not illuminated	ON  OFF	– Data communication not yet started – Data communication faulty – Timeout – Hardware reset	

<b>ERROR - data communication faulty</b>			
<b>LED (red)</b>	<b>Process</b>	<b>Status</b>	<b>Significance/error handling</b>
 LED illuminated	ON  OFF	Data communication faulty	→ Section 4.4.4
 LED flashing	ON  OFF	CRC fault and data communication fault	
 LED not illuminated	ON  OFF	No error. Data communication OK	

<b>SD – Send Data</b>			
<b>LED (yellow)</b>	<b>Process</b>	<b>Status</b>	<b>Significance/error handling</b>
 LED flashing	ON  OFF	CPX terminal sends data	→ Section 4.4.4
 LED not illuminated	ON  OFF	CPX terminal does not receive any data	

RD – Receive Data			
LED (yellow)	Process	Status	Significance/error handling
 LED illuminated	ON OFF 	CPX terminal receives data	→ Section 4.4.4
 LED not illuminated	ON OFF 	CPX terminal does not receive any data	

**4.4.4 Possible operating statuses of CC-Link-specific LEDs**

LED status				Significance
RUN	ERROR	SD	RD	
				Normal communication, but frequent CRC faults (e.g. due to interference/noise). Setting of the baud rate or the station address has been modified since the last fieldbus initialization.
				The bus node cannot reply; the received data cause a CRC fault.
				Normal communication during the operation (transmission and reception).
				No data to the master.
				Bus node replies to a request for data, but the Refresh Reception caused a CRC fault.
				Data for the master causes a CRC fault.
				Connection initialization has failed.
				Either no data to the master or data for the slave cannot be received (e.g. due to interference/noise)
				No data reception possible, e.g. due to wire fracture, power OFF/ON required.
			 	Fault in baud rate and/or CC-Link slave address.
 LED illuminated;  LED flashing;  LED not illuminated				

Tab. 4.3 Overview CC-Link LEDs

## 4.5 Diagnostics via fieldbus CC-Link

The CPX terminal enables diagnostics via the fieldbus. The following diagnostics options are supported here:

- Status bits (system status)
- I/O diagnostics interface (system diagnostics)

### 4.5.1 Status bits

The status bits serve to display common diagnostic messages (global error message).

These status bits are treated like inputs and are transmitted to the master with the other inputs. They can be queried there as “standard” inputs, linked and processed.

The status bits always occupy the first 8 input bits in the word area of station 1 (→ Section 3.2.2).



#### Note

In order to use the I/O diagnostics interface, the system diagnostics must be activated via the DIL switch on the bus node (→ Section 2.4.10).

The information of the status bits is only available provided interrogation of the I/O diagnostic interface is not active (control bit has 0-signal, → Tab. 3.3 or CPX system description P.BE-CPX-SYS-...).

Bit	Diagnostic information with logic 1	Description
0	Error at valve	Module type in which an error has occurred
1	Error at output	
2	Error at input	
3	Error at analogue module/technology module	
4	Undervoltage	Error type
5	Short circuit/overload	
6	Wire break	
7	Other error	

Tab. 4.4 Overview of status bits

If all status bits supply logic 0, no error will be reported.

If various errors occur simultaneously on different types of modules, these errors cannot be assigned via the status bits. Errors can be uniquely defined via the I/O diagnostics interface, if needed.



Further instructions on the function and content of the status bits are found in the CPX system description (P.BE-CPX-SYS-...).

### 4.5.2 I/O diagnostics interface

Detailed diagnostics information can be accessed via the I/O diagnostics interface, e.g.:

- You can ascertain on which module and on which channel a fault has occurred.
- The last 40 fault messages are recorded and can be accessed (Diag. trace).

Available for accessing the system diagnostics are 16 input bits and 16 output bits, through which all diagnostics data can be read.



#### Note

In order to use the I/O diagnostic interface, the system diagnostics must be activated via the DIL switch on the bus node (➔ Section 2.4.10).

The status bits and the I/O diagnostic interface of the system diagnostics occupy, if activated, the first 2 bytes respectively of the inputs and outputs of the word range of the Station 1 (➔ e.g. Fig. 3.1).



Instructions on diagnostics with the I/O diagnostics interface are found in the CPX system description (P.BE-CPX-SYS-...).

## 5 Function module F23

### 5.1 General instructions



**Note**

In this chapter, all the specific facts of the bus node CPX-FB23-24 are described in the configuration for the function module F23 (CC-Link version 1.1).  
The general information in chapters 2 to 4 valid for use for both configuration versions is indicated with appropriate cross-references.



**Note**

Under certain conditions the bus node can be operated on a CC-Link master of version 1.1 also in the configuration as a function module F24 (CC-Link version 2.0).  
For more information, see → Section 3.5.

### 5.2 Installation



The instructions and descriptions for installation in chapter 2 are valid also for the configuration as function module F23, with the exception of sections 2.4.4 and 2.4.8.

Instead of them, the following sections are valid for function module F23:

- Section 5.2.1 instead of section 2.4.4
- Section 5.2.2 instead of section 2.4.8

### 5.2.1 Setting the operating mode

You set the operating mode of the bus node with the DIL switch element 1.1 of DIL switch 1.

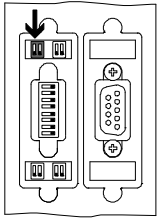

Operating mode	Setting DIL switch 1	
<p><b>Remote I/O operating mode</b> All functions of the CPX terminal are controlled directly by the higher-order PLC/IPC. The bus node undertakes the required connection to CC-Link.</p>		1.1: OFF (factory setting)
<p><b>Remote controller operating mode</b> An FEC or CEC integrated into the CPX terminal controls all functions of the CPX terminal, i.e. the FEC or CEC undertakes the I/O control. The bus node undertakes, if necessary, the additional connection to CC-Link for supplementary functions (e.g. interrogating of status information).</p>		1.1: ON

Tab. 5.1 Operating mode



**Note**



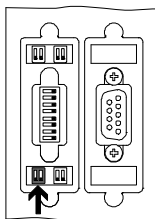

The setting of the operating mode with the DIL switch has priority over all other settings.

### 5.2.2 Setting the number of stations per slave / number of I/O bytes



Use the DIL switch elements 4.1 and 4.2 of the DIL switch 4 to set the number of stations per slave or the number of I/O bytes of the bus node.

The function of this DIL switch is dependent on the set operating mode of the CPX terminal (➔ Tab. 5.1).

Remote I/O operating mode	Remote controller operating mode	Setting DIL switch 4	
Number of stations per slave	Number of I/O bytes		
<b>1 station per slave</b>	<b>1 station per slave</b> With an FEC or CEC in the CPX terminal, the bus node must be operated as a remote controller and occupies 8 I/O bytes for communication.		4.1: OFF 4.2: OFF
<b>2 stations per slave</b>	Invalid		4.1: ON 4.2: OFF
<b>3 stations per slave</b>			4.1: OFF 4.2: ON
<b>4 stations per slave</b>			4.1: ON 4.2: ON (factory setting)

Tab. 5.2 No. of stations per slave

With operating mode “Remote I/O” you can set the number of stations per slave with the DIL switches 4.1 and 4.2.

The required setting of the number of stations depends on the expansion of the CPX terminal (modules used) as well as whether or not the I/O diagnostic interface is used (➔ Examples in section 5.3.1).

The assigned I/O bits are in some cases reserved for system functions and are therefore not available for the address space of the CPX modules.

In the remote controller operating mode, DIL switches 4.1 and 4.2 must be set to “OFF”.

The bus node undertakes the connection to a CC-Link, if applicable for additional functions. For communication of the bus node with an FEC integrated into the CPX terminal or CEC, 8 I/O bytes are assigned.

Further information on the number of stations per slave can be found in section 2.4.7.

Observe the general rules on addressing in the description for your CC-Link master.

## 5.3 Commissioning



The instructions and descriptions for commissioning in the section 3.1 are also valid for the function module F23.



### Caution

For operation of the bus node CPX-FB23-24 as a function module F23 (CC-Link version 1.1), the DIL switch element 3.8 must be set to “OFF”. Observe the notes in section 2.4.6.

### 5.3.1 Configuration and addressing

#### Number of inputs/outputs



#### Note

- Note that the CPX terminal also provides I/Os for system diagnostics (status bits and I/O diagnostics interface), depending on the setting of the DIL switches.
- For an active system diagnostics function, it occupies the first 16 inputs and outputs of station 1 in the word area (RW<sub>r</sub>, RW<sub>w</sub>). The rest of the address space of the 1st station in the word area is reserved.
- Providing no detailed diagnostic information is requested via the 16 outputs of the I/O diagnostic interface, the first 8 inputs of the I/O diagnostics interface represent the status bits.
- The maximum possible extension of the CPX terminal is defined by the maximum number of modules and the set number of stations.



Detailed information on the electric and pneumatic modules are found in the Festo Support Portal (→ [www.festo.com](http://www.festo.com)).



### **Addressing rules**

#### **I/O counting mode**

- The address assignment of the inputs is independent of the address assignment of the outputs.
- The counting mode is independent of the position of the bus node in the CPX terminal.
- Counting from left to right, corresponding to the installation position in the CPX terminal and dependent on the module type.
- Digital I/Os, analogue I/Os and I/Os of technology modules occupy their address space, ascending respectively without gaps in the corresponding address space.
- Digital I/Os, analogue I/Os and I/Os of technology modules occupy their own stations, ascending respectively without gaps.
- The following I/Os are assigned separately from each other:
  - Remote ready (RR, CC-Link-specific reserved, always lies in the last reserved station)
  - Diagnostic I/Os (only if configured)
  - Digital I/Os
  - Analogue I/Os, I/Os of function modules

– The following table applies for the sequence of address assignment:

Address assignment (address type)		Area	Addressing rules
1	Remote ready (RR)	Bit area	<ul style="list-style-type: none"> <li>– The last 16 inputs and outputs (2 byte each) in the bit area (RX, RY) of the last assigned station are CC-Link-specifically reserved.</li> </ul>
2	System diagnostics mode (status bits and I/O diagnostics interface) <sup>1)</sup>	Word area	<ul style="list-style-type: none"> <li>– The system diagnostics occupy the first 16 inputs and outputs in the word area (RW<sub>r</sub>, RW<sub>w</sub>) of station 1 <sup>1)</sup></li> </ul>
3	Digital I/O modules, e.g.: <ul style="list-style-type: none"> <li>– CPX-4DE</li> <li>– CPX-8DE</li> <li>– CPX-4DA</li> <li>– CPX-8DE-8DA</li> </ul> or Pneumatic interfaces, e.g.: <ul style="list-style-type: none"> <li>– CPX-VMPPA-...</li> <li>– CPX-VPMPA-FB-...</li> </ul> or Pneumatic modules, e.g.: <ul style="list-style-type: none"> <li>– VMPA1S-D... <sup>2)</sup></li> <li>– VMPA2S-D... <sup>2)</sup></li> </ul>	Bit area	<ul style="list-style-type: none"> <li>– Addresses are assigned in the free bit area (RX/RY) of stations 1 to 4.</li> <li>– Arrangement from left to right corresponding to the address space, one next to the other across the station limits (ascending without gaps)</li> </ul>
4	Analogue modules, e.g.: <ul style="list-style-type: none"> <li>– CPX-2AE-...</li> <li>– CPX-2AA-...</li> </ul>	Word area	<ul style="list-style-type: none"> <li>– Addresses are assigned in the word area (RW<sub>r</sub>/RW<sub>w</sub>)</li> <li>– The first module lies at a new station address</li> <li>– Addresses are assigned in the address space after digital I/O modules and pneumatic modules.</li> <li>– Arrangement from left to right corresponding to the address space one next to the other</li> <li>– Maximum 4 stations can be assigned</li> </ul>
5	Technology modules e.g.: <ul style="list-style-type: none"> <li>– CPX-FEC</li> <li>– CPX-CEC-...</li> <li>– CPX-CTEL-...</li> <li>– CPX-CMAX-C1-2</li> </ul>		

1) Only with activated system diagnostics

2) Type of electronic module included.

Tab. 5.3 I/O counting mode: addressing rules for the CPX modules

**Number of assigned stations**



Observe the following examples for determining the required number of stations and the rules for addressing.

Depending on the number of selected stations per slave, a target/actual comparison is made of the assigned address space in the starting phase of the bus node.

If the number of stations selected by means of DIL switches is less than the recognized periphery, the SF LED on the bus node will flash (→ Tab. 5.2).

If the recognized periphery, and thus the number of stations required, is less than the number of stations selected using DIL switches, this is not interpreted as a fault, but is left to the decision of the user.

**General examples – address allocation**

The following diagrams show the address assignment of the inputs and outputs for various configurations of the CPX terminal when the bus node is operated as function module F23.

**Digital I/O modules (≤ 16 I/O)**

- 1 station
  - I/O data in the bit area
  - System diagnostics (optional)
- I: digital input  
O: digital output

		<b>Bit area</b>		<b>Word area</b>	
		RX	RY	RWr	RWw
		Inputs	Outputs	Inputs	Outputs
Station 1		I15 ... I0	O15 ... O0	0	System diagnostics (16 I/O)
		Remote ready (RR = bit 11)		1	Reserved
				2	Reserved
				3	Reserved

Fig. 5.1 CC-Link memory mapping (≤ 16 digital inputs and outputs)

**Digital I/O modules (≤ 80 I/O)**

- 3 stations
- I/O data in the bit range
- System diagnostics (optional)
- I: digital input
- O: digital output

		<b>Bit area</b>		<b>Word area</b>	
		RX	RY	RWr	RWw
		Inputs	Outputs	Inputs	Outputs
Station 1		I15 ... I0	O15 ... O0	0	System diagnostics (16 I/O)
		I31 ... I16	O31 ... O16	1	Reserved
				2	Reserved
Station 2		I47 ... I32	O47 ... O32	3	Reserved
		I63 ... I48	O63 ... O48	1	Reserved
				2	Reserved
Station 3		I79 ... I64	O79 ... O64	3	Reserved
		Remote ready (RR = bit 11)		1	Reserved
				2	Reserved
				3	Reserved

Fig. 5.2 CC-Link memory mapping (≤ 80 digital inputs and outputs)

**Analogue I/O modules (≤16 AI / AO) without system diagnostics**

- 1 to 4 stations:
- 1 : ≤ 4 AI / AO
- 2 : ≤ 8 AI / AO
- 3 : ≤ 12 AI / AO
- 4 : ≤ 16 AI / AO
- Analogue I/O data in the word range
- No system diagnostics
- AI: analogue input
- AO: analogue output

		<b>Bit area</b>		<b>Word area</b>	
		RX	RY	RWr	RWw
		Inputs	Outputs	Inputs	Outputs
Station 1		Reserved	Control	0	AI0
		Reserved	Reserved	1	AO0
Station 2		Reserved	Control	2	AI1
		Reserved	Reserved	3	AO1
Station 3		Reserved	Control	0	AI2
		Reserved	Reserved	1	AO2
Station 4		Reserved	Control	2	AI3
		Reserved	Reserved	3	AO3
Station 1		Reserved	Control	0	AI4
		Reserved	Reserved	1	AO4
Station 2		Reserved	Control	2	AI5
		Reserved	Reserved	3	AO5
Station 3		Reserved	Control	0	AI6
		Reserved	Reserved	1	AO6
Station 4		Reserved	Control	2	AI7
		Reserved	Reserved	3	AO7
Station 1		Reserved	Control	0	AI8
		Reserved	Reserved	1	AO8
Station 2		Reserved	Control	2	AI9
		Reserved	Reserved	3	AO9
Station 3		Reserved	Control	0	AI10
		Reserved	Reserved	1	AO10
Station 4		Reserved	Control	2	AI11
		Reserved	Reserved	3	AO11
Station 1		Reserved	Control	0	AI12
		Reserved	Reserved	1	AO12
Station 2		Reserved	Control	2	AI13
		Reserved	Reserved	3	AO13
Station 3		Reserved	Control	0	AI14
		Reserved	Reserved	1	AO14
Station 4		Reserved	Control	2	AI15
		Reserved	Reserved	3	AO15

Fig. 5.3 CC-Link memory mapping (≤ 16 analogue inputs and outputs)

**Analogue I/O modules ( $\leq 12$  AI / AO) with system diagnostics**

<ul style="list-style-type: none"> <li>– 2 to 4 stations:</li> <li>  2 : <math>\leq 4</math> AI / AO</li> <li>  3 : <math>\leq 8</math> AI / AO</li> <li>  4 : <math>\leq 12</math> AI / AO</li> </ul>		<b>Bit area</b>		<b>Word area</b>		
		RX	RY	RWr	RWw	
		Inputs	Outputs	Inputs	Outputs	
<ul style="list-style-type: none"> <li>– Analogue I/O data in the word range</li> <li>– With system diagnostics</li> </ul>	Station 1	Reserved	Control	0	System diagnostics (16 I/O)	
		Reserved	Reserved	1	Reserved	Reserved
<ul style="list-style-type: none"> <li>AI: analogue input</li> <li>AO: analogue output</li> </ul>	Station 2	Reserved	Control	0	AI4	AO4
		Reserved	Reserved	1	AI5	AO5
				2	AI6	AO6
				3	AI7	AO7
	Station 3	Reserved	Control	0	AI8	AO8
		Reserved	Reserved	1	AI9	AO9
				2	AI10	AO10
				3	AI11	AO11
	Station 4	Reserved	Control	0	AI12	AO12
		Remote ready (RR = bit 11)		1	AI13	AO13
				2	AI14	AO14
				3	AI15	AO15

Fig. 5.4 CC-Link memory mapping ( $\leq 12$  analogue inputs and outputs)

**Digital and analogue I/O modules ( $\leq 64$  I/O and  $\leq 8$  AI / AO) with or without system diagnostics**

<ul style="list-style-type: none"> <li>– 4 stations</li> <li>– Analogue I/O data in the word range</li> <li>– System diagnostics (optional)</li> </ul>		<b>Bit area</b>		<b>Word area</b>		
		RX	RY	RWr	RWw	
		Inputs	Outputs	Inputs	Outputs	
<ul style="list-style-type: none"> <li>I: digital input</li> <li>O: digital output</li> <li>AI: analogue input</li> <li>AO: analogue output</li> </ul>	Station 1	I15 ... I0	O15 ... O0	0	System diagnostics (16 I/O)	
		I31 ... I16	O31 ... O16	1	Reserved	Reserved
				2	Reserved	Reserved
				3	Reserved	Reserved
	Station 2	I47 ... I32	O47 ... O32	0	Reserved	Reserved
		I63 ... I48	O63 ... O48	1	Reserved	Reserved
				2	Reserved	Reserved
				3	Reserved	Reserved
	Station 3	Reserved	Control	0	AI0	AO0
		Reserved	Reserved	1	AI1	AO1
				2	AI2	AO2
				3	AI3	AO3
	Station 4	Reserved	Control	0	AI4	AO4
		Remote ready (RR = bit 11)		1	AI5	AO5
				2	AI6	AO6
				3	AI7	AO7

Fig. 5.5 CC-Link memory mapping ( $\leq 64$  digital and  $\leq 8$  analogue inputs and outputs)

**Configuration example****Digital and analogue I/Os and MPA pneumatics**

The following example describes a specific configuration of a CPX terminal with digital and analog I/O modules and MPA pneumatics, and the resulting number of stations depending on the I/O data.

Mod. No.	Electric modules	Module identifier <sup>1)</sup>	Assigned addresses			
			RX	RY	RWr	RWw
0	Bus node FB23-24 (F23) with system diagnostics	FB23-RIO	2 byte <sup>2)</sup>	2 byte <sup>2)</sup>	8 byte <sup>3)</sup> (4 words)	8 byte <sup>3)</sup> (4 words)
1	Digital 8-fold input module	8DI	1 byte	–	–	–
2	Analogue 2-fold input module	2AI	–	–	4 bytes (2 words)	–
3	Digital 8-fold input module	8DI	1 byte	–	–	–
4	Analogue 2-fold output module	2AO	–	2 bytes <sup>4)</sup>	–	4 bytes <sup>4)</sup> (2 words)
5	MPA pneumatic module (type 32) with galvanic isolation	MPA1S	–	1 byte	–	–
6	MPA pneumatic module (type 32) with galvanic isolation	MPA1S	–	1 byte	–	–
	Sum of the respective address ranges		4 bytes	6 bytes	12 bytes (2 words)	12 bytes (2 words)

- 1) Module identifiers on the Festo Maintenance Tool (CPX-FMT) or handheld terminal (CPX-MMI), for I/O modules these are shown in the inspection window of the module.
- 2) Remote ready bit always occupies the address space of 2 bytes in the bit range (RX, RY) at the end of the last station with 1 bit.
- 3) The system diagnostics (status bits and I/O diagnostic interface) occupies 16 I/Os (the first word) in the word range of station 1 (RWr, RWw). The remaining words in the address space of Station 1 are reserved.
- 4) Analogue output modules occupy one control bit per output in the bit area of the assigned station (RY). The remaining bits are reserved.

Tab. 5.4 Configuration for example terminal from Fig. 5.6

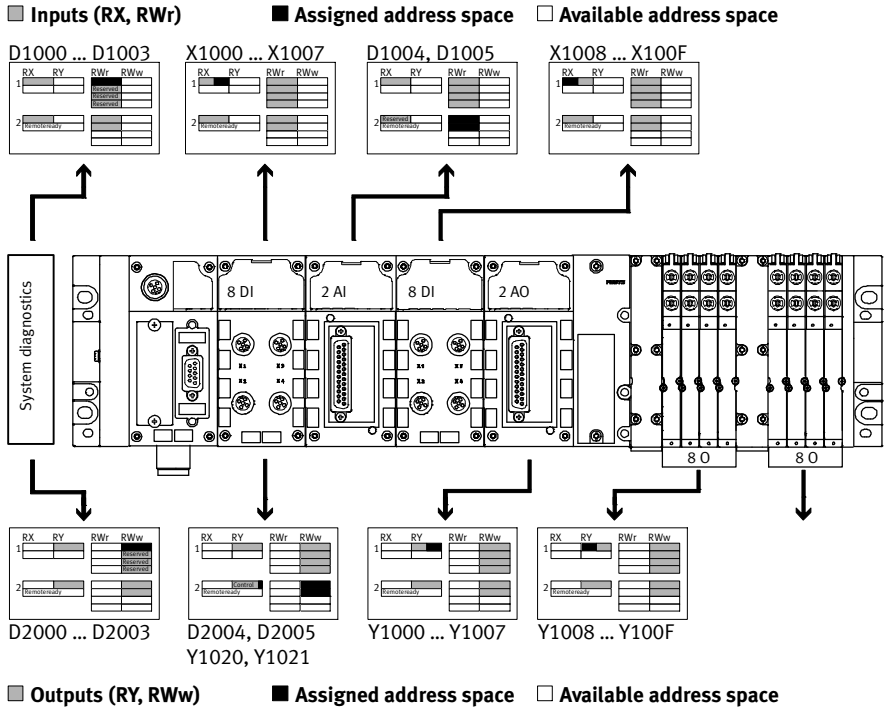

X1000, Y1000, D1000, D2000... Example of representation of the CC-Link address assignment (hexadecimal)

Fig. 5.6 Addressing within the CPX terminal in the example from Tab. 5.4

### 5.3.2 Address assignment after extension/conversion

If the machine requirements change, the CPX terminal can be adapted as required due to its modular design.



#### Caution

If the CPX terminal is extended or converted at a later stage, input/output addresses may be shifted. This applies in the following cases:

- Additional modules are inserted between existing modules.
- Existing modules are removed or replaced by other modules which have fewer or more input/output addresses.
- Interlinking blocks and/or pneumatic manifold blocks for monostable valves are replaced by interlinking blocks/manifold blocks for bistable valves or vice versa (→ Pneumatics description).
- Additional interlinking blocks and/or manifold blocks are inserted between existing ones.
- The configured addresses of the pneumatics interface are modified.

If the configuration of a CPX terminal is changed, the required number of stations must be determined and adjusted to correspond with the new address assignment (→ Fig. 5.6).



Moreover, it should be noted that the needed address space may increase due to modification of the CPX terminal and thus the slave addresses of the following slaves in the field-bus must be checked and adjusted, if necessary.

### 5.3.3 CC-Link memory mapping

#### Remote ready (RR, CC-Link-specific)

The remote ready bit is set to “1” by bus node after successful initialization. The address space of 2 bytes is always assigned with 1 bit in the bit range (RX, RY) at the end of the last station (→ e.g. Fig. 5.5).

Bit 11 of the input section (RX) includes the remote ready bit.

#### Digital inputs and outputs (I/Os)

If the first station is not occupied by analogue I/Os, digital I/Os occupy the bit range (RX/RY) from the first station, one after the other (→ Section 5.3.1).



**Analogue inputs and outputs**

If the first station is not occupied by system diagnostics or digital I/Os, analogue I/Os occupy the word range (RWr/RWw) from the first station, one after the other (➔ Section 5.3.1).

**Control bits for analogue outputs**

Analogue outputs additionally occupy one control bit each in the bit area of the corresponding station. The bit area of the stations used by the analogue outputs is reserved.

Analogue outputs can be activated or deactivated with the word “Control” in the bit area of the relevant station (➔ Tab. 5.5). The following bits are used here:

<b>Control</b>																
<b>Slave &gt; Master – RX(n+m)</b>																
Bit:	15	14	13	12	11	10	9	8	7	6	5	4	3	2	1	0
Signal:	Reserved															
<b>Master &gt; Slave – RY(n+m)</b>																
Bit:	15	14	13	12	11	10	9	8	7	6	5	4	3	2	1	0
Signal:	Reserved												S3	S2	S1	S0

S...: Enable/Disable channel 0, 1, 2, 3 (and/or 4, 5, 6, 7 or 8, 9, 10, 11 or 12, 13, 14, 15)

Control bit for the relevant analogue output. The relevant output is reset with a 0-signal.

n: assigned CC-Link slave address

m: 1st Station: m = 0

2nd Station: m = 2

3rd Station: m = 4

4th Station: m = 6

Tab. 5.5 Control

### System diagnostics

The following tables show the assignment of the word area of the first station of the CPX terminal with activated system diagnostics.

Slave ▶ Master		Master ▶ Slave	
Device no.	Signal name	Device no.	Signal name
RWr(n)0	System diagnostics	RWw(n)0	System diagnostics
RWr(n)1	Reserved	RWw(n)1	Reserved
RWr(n)2			
RWr(n)3			

n: assigned address in memory mapping (master), depends on set station address

Tab. 5.6 System diagnostics: assignment

### System diagnostics (→ CPX system description)

Slave ▶ Master – RWr(n)0																
Bit:	15	14	13	12	11	10	9	8	7	6	5	4	3	2	1	0
Signal:	Q	Reserved							Diagnostics data When the control signal returns 0, the bits 0 ... 7 represent the status bit (→ Section 4.5.1)							
Master ▶ Slave – RWw(n)0																
Bit:	15	14	13	12	11	10	9	8	7	6	5	4	3	2	1	0
Signal:	S	Reserved	Function number													

n: assigned CC-Link slave address

Q: acknowledgment bit; S = control bit

Tab. 5.7 System diagnostics: I/O diagnostics interface and status bits

### 5.3.4 Fieldbus configuration

Before a slave can be connected (e.g. bus node CPX-FB23-24) to the CC-Link master, various configuration settings must be made, e.g.:

- Number of connected slaves
- Number of stations to be connected to the system again during a scanning cycle
- Status in case of a CPU fault in the computer
- Station data (settings of the slave):
  - Station type (CPX-FB23-24: remote device station)
  - CC-Link slave address (1 ... 64)
  - Function module F23
  - Protocol version CC-Link 1.1 (→ Note)
  - Number of stations occupied by the slave (1 ... 4).

The configuration settings are saved in the master station buffer memory. The settings can be set as follows, for example (in some cases depending on the master):

- With the GX developer
- Through manual programming using PLC code



General information on the fieldbus CC-Link is found in the documentation for your CC-Link master and for the relevant control systems (e.g. from Mitsubishi). An overview can be found under [www.cc-link.org](http://www.cc-link.org).



#### Note

When operating as a function module F23 **with a master of the CC-Link version 2.0**, the bus node must be configured in the master as CC-Link 1.1 slave.

## 5.4 Parameterisation

### Parameters of the CPX terminal



For all the information you need for parameterisation of the CPX terminal, see 3.3.

## 5.5 Commissioning of the CPX terminal on the fieldbus



The instructions and descriptions for commissioning in the section 3.4.1 and 3.4.3 are also valid for the function module F23.

The descriptions of the section 3.4.2 are to be replaced for the function module F23 by section 5.5.1.

### 5.5.1 RUN/PAUSE and STOP of the master

In the STOP mode of the CC-Link master (e.g. by interruption of communication), the status of the outputs in the bit area (RY) and word area (RWw) is dependent on the DIL switch setting HOLD/CLEAR (→ Section 2.4.9).

The following table shows the reaction according to CC-Link specifications:

CC-Link master status	DIL switch setting	
	CLEAR	HOLD
<b>RUN/PAUSE</b>	Normal operation (Refresh)	
<b>STOP</b>	The outputs (RY/RWw) are reset.	The outputs (RY/RWw) retain their status.

Tab. 5.8 RUN/PAUSE and STOP of the master



#### Note

With STOP, the enable bits of the analogue outputs (control) are set to 0. The analogue outputs will then also be set.

## 5.6 General notes on diagnostics and error handling



The instructions and descriptions for diagnostics and error handling in the sections 4.1 and 4.5.2 are also valid for the function module F23.

## A Technical appendix

### A.1 Technical data

General	Function module	
	F24	F23
<b>General technical data</b>	→ CPX system description (P.BE-CPX-SYS-...)	
<b>Degree of protection</b> according to EN 60529  – With fieldbus plug FBS-SUB-9-GS-2X4POL-B – With manifold block FBA-1-KL-5POL or other fieldbus plugs	CPX terminal completely mounted, plug connector in accordance with accessories plugged in or equipped with cover cap IP65/IP67 (mounted completely) IP20	
<b>Protection against electric shock</b> (protection against direct and indirect contact in accordance with IEC/DIN 60204-1)	By means of PELV power circuit (Protected Extra Low Voltage)	
<b>Module code (CPX-specific)</b> Remote I/O Remote controller	206 –	206 157
<b>Module identifiers (CPX-MMI-1, CPX-FMT)</b> Remote I/O Remote controller	FB24-RIO –	FB23-RIO FB23-RC
<b>Power supply</b>		
<b>Operating voltage / load voltage</b>	→ CPX system description (P.BE-CPX-SYS-...)	
<b>Current consumption bus node CPX-FB23-24</b> Internal current consumption at 24 V (internal electronics): – from operating voltage supply for electronics/sensors ( $U_{EL/SEN}$ )	typ. 70 mA at 24 V (internal electronics)	
<b>Galvanic isolation</b> – between bus interface and CPX periphery (power supplies)	Yes	

<b>Fieldbus</b>	
<b>Status information</b>	
<ul style="list-style-type: none"> <li>– Protocol</li> <li>– Version</li> <li>– CC-Link chip</li> <li>– Vendor code</li> <li>– Machine type</li> </ul>	CC-Link Version 1.1 and 2.0 MFP3 0x0177 0x3C
<b>Transmission rates</b> (The maximum permitted fieldbus length depends on the baud rate used, → section 2.5.2)	156 kBd, 625 kBd, 2,5 MBd, 5 MBd, 10 MBd
<b>Coupling and uncoupling during operation</b>	Yes (online-return function, slave station cut-off function)
<b>Cable type</b>	Cable specification (→ Section 2.5.1)
<ul style="list-style-type: none"> <li>– Reference cable (KURAMO ELECTRIC Co., Ltd.)</li> <li>– Alternative (DYDEN Corporation)</li> <li>– Alternative (LEONI protec cable Systems GmbH)</li> <li>– Terminating resistor</li> </ul>	FANC-110SBH, 20 AWG × 3 CC-110, CC-110-5, CS-110, CM-110-5, 20 AWG × 3 L45467-Y19-C15, 20 AWG × 3 110 Ω / 0.5 W

## A.2 Default parameterisation



### Note

The following tables contain an overview of parameters of the bus node. The current and detailed description of all parameters of a CPX terminal are found in the CPX system description (P.BE-CPX-SYS-...) as well as in the description of each CPX module.

<b>System parameters</b>	<b>Function no.</b>	<b>Default setting</b>
<b>Monitoring</b>	4401	
<ul style="list-style-type: none"> <li>– Short circuit/overload in sensor supply (SCS)</li> <li>– Short circuit/overload at the outputs (SCO)</li> <li>– Undervoltage at the outputs (<math>U_{OUT}</math>)</li> <li>– Undervoltage at valves (<math>U_{VAL}</math>)</li> <li>– Short circuit at valves (SCV)</li> </ul>		active active active active active
<b>Force mode</b> Defines whether the Force function is blocked globally or enabled.	4402	blocked
<b>System start</b> Defines the starting reaction of the CPX terminal. Saves current parameter settings.	4402	System start with default parameterisation (factory setting) and current CPX expansion.

Tab. A.1 System parameters

<b>Diagnostic memory parameters</b>	<b>Function no.</b>	<b>Default setting</b>
<b>Entries remain up to Power OFF</b> Contents of the diagnostic memory will be deleted after new Power ON.	3480	active
<b>Run/stop filter 1</b> Defines the saved errors.	3480	Saves the last 40 errors (overwrites old entries)
<b>Run/stop filter 2</b> Defines when the recording of errors is to be started or stopped.	3484	Run/Stop filter 2 inactive
<b>End of error filter</b> Defines whether current errors are to be recorded or not.	3484	Record going errors (error end) (filter inactive)
<b>Error number filter</b> Suppresses or exclusively records certain errors.	3484	Error number filter inactive
<b>Module/channel filter</b> Exclusive recording of errors of a module or channel (→ function nos. 3485...3486).	3484	Module/channel filter inactive
<b>Module number (MN)</b> Module number for the diagnostic memory filter	3485	Module number 0
<b>Channel number (CN)</b> Channel number for the diagnostic memory filter	3486	Channel number 0
<b>Error number (FN)</b> Error number for the diagnostic memory filter	3487	Error number 0

Tab. A.2 Diagnostic memory parameters

### A.3 Accessories



- Accessories are found in our online catalogue (→ [www.festo.com/catalogue](http://www.festo.com/catalogue)) on the Internet.

## B Glossary

### B.1 List of abbreviations

The following product-specific terms and abbreviations are used in this description:

<b>Term/abbreviation</b>	<b>Significance</b>
Address space	The sum of available addresses, independent of the assignment.
Address volume	The sum of the actually utilised user data.
AI	Analogue input (input channel, 16 bits)
AO	Analogue output (output channel, 16 bits)
Bus node	Create the connection to certain networks and fieldbuses, conduct control signals to the connected modules and monitor their functioning capability.
CC-Link	Control & Communication Link fieldbus system from Mitsubishi
CEC	CoDeSys controller, e.g. CPX-CEC..., applicable for configuration, commissioning and programming of various components and equipment from Festo.
CPX modules	Collective term for the various modules which can be integrated into a CPX terminal.
CPX system description (P.BE-CPX-SYS-...)	Description that gives an overview of structure, components, function, installation and commissioning as well as basic information on parameterisation of CPX terminals (→ <a href="http://www.festo.com">www.festo.com</a> ).
CPX terminal	Modular electrical terminal
Diagnostic data	Detailed diagnostic information
DIL switches	Dual-in-line switches consist of several switch elements with which settings can be made.
FEC	Front-end controller, e.g. CPX-FEC, can be used as: <ul style="list-style-type: none"> <li>– fieldbus slave (remote I/O operating mode)</li> <li>– system controller (PLC, remote controller operating mode)</li> <li>– stand-alone system controller (PLC, stand-alone operating mode)</li> </ul>
I	Digital input
I/O diagnostics interface	The I/O diagnostics interface is a bus-independent diagnostics interface at I/O level, permitting access to internal data of the CPX terminal.
I/O modules	Common term for the CPX modules which provide digital inputs and outputs (CPX input modules and CPX output modules)
I/Os	Digital inputs and outputs
O	Digital output
Parameter	With the aid of parameterisation, the characteristics of the CPX terminal or the characteristics of the individual modules and I/O channels can be adapted to each particular application. Parameters can be read and modified.
PLC/IPC	Programmable logic controller/industrial PC



<b>Term/abbreviation</b>	<b>Significance</b>
Pneumatic interface	The pneumatic interface is the interface between the modular electrical peripherals and the pneumatics.
RWr/RWw	Analogue input and output words (16 bits) in the word area of the CC-Link memory mapping (register word read/register word write).
RX/Ry	Digital input and output data (bits) in the bit range of the CC-Link memory mapping.
Status bits	Internal inputs that supply coded common diagnostic messages.
Useful data volume	Sum of the maximum possible dataset that can be occupied by digital and analogue inputs and outputs, of CPX modules in the corresponding address space of the bus node.

Tab. B.1 CPX-specific and/or CC-Link specific terms and abbreviations

## Index

<b>A</b>		<b>F</b>	
Abbreviations, Product-specific .....	80	Fieldbus baud rate .....	26
Addressing rules		Fieldbus cable .....	25
– F24 .....	35	Fieldbus configuration	
– F23 .....	65	– F24 .....	44
		– F23 .....	75
<b>B</b>		Fieldbus connection .....	31
Baud rate .....	16, 26	Fieldbus length .....	26
Branch lines .....	27	Function module	
		– F24 .....	6
		– F23 .....	6
<b>C</b>		<b>H</b>	
Cable, Fieldbus .....	25	HOLD/CLEAR .....	23
CC-Link memory mapping		<b>I</b>	
– F24 .....	42	I/O diagnostics interface .....	24
– F23 .....	72	Intended use .....	7
CC-Link slave address, Set .....	18	<b>L</b>	
CLEAR .....	23	LEDs .....	53
Configuration as F24 or F23 .....	17	– CC-Link-specific .....	57
Configuration example .....	39	– CPX-specific .....	55
Connect		– Normal operating status .....	54
– Fieldbus .....	25, 28	<b>M</b>	
– Power supply .....	32	Mapping optimisation .....	21
– Terminating resistor .....	28	<b>N</b>	
CPX system description, P.BE-CPX-SYS-....	80	Notes on the documentation .....	6
		Number of stations per slave .....	63
<b>D</b>		<b>O</b>	
Diagnostics		Operating mode .....	15, 62
– via CC-Link .....	59		
– via I/O diagnostics interface .....	60		
– via LEDs .....	53		
Diagnostics options, Overview .....	51		
DIL switches			
– Layout .....	14		
– Set .....	14		
<b>E</b>			
Examples of addressing			
– F24 .....	37		
– F23 .....	67		

**P**

Parameterisation ..... 45  
 Parameterisation concepts  
 – Handheld terminal (CPX-MMI) ..... 47  
 – Festo Maintenance Tool (CPX-FMT) ..... 47  
 Pin allocation, Fieldbus interface ..... 28  
 Power supply ..... 32

**R**

RAS ..... 48  
 RUN/PAUSE  
 – F24 ..... 48  
 – F23 ..... 76

**S**

Safety instructions, General ..... 7  
 Screened connection ..... 29, 30

**Set**

– Baud rate ..... 16  
 – CC-Link slave address ..... 18  
 – Configuration as F24 or F23 ..... 17  
 – HOLD/CLEAR ..... 23  
 – I/O diagnostics interface ..... 24  
 – Mapping optimisation ..... 21  
 – Number of stations per slave ..... 63  
 – Operating mode ..... 15, 62  
 – System diagnostics ..... 24  
 Stations, Number ..... 67  
 Status bits ..... 59  
 STOP  
 – F24 ..... 48  
 – F23 ..... 76  
 Strain relief ..... 25

**T**

Technical data ..... 77  
 Terminating resistor ..... 28, 31



Reproduction, distribution or sale of this document or communication of its contents to others without express authorization is prohibited. Offenders will be liable for damages. All rights reserved in the event that a patent, utility model or design patent is registered.

Copyright:  
Festo SE & Co. KG  
Postfach  
73726 Esslingen  
Germany

Phone:  
+49 711 347-0

Fax:  
+49 711 347-2144

e-mail:  
[service\\_international@festo.com](mailto:service_international@festo.com)

Internet:  
[www.festo.com](http://www.festo.com)

Original: de