

Terminal CPX

Axis controller CPX-CMAX-C1-1

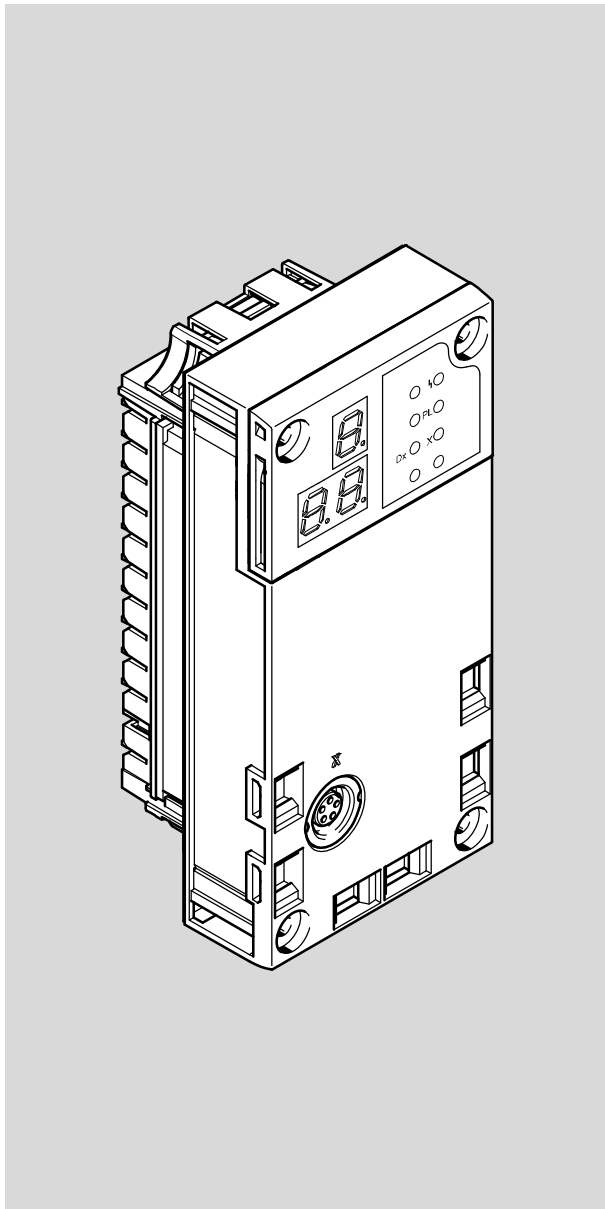

FESTO

Description

Axis controller
CPX-CMAX-C1-1

System description

Mounting,
installation and
diagnostics of
positioning system

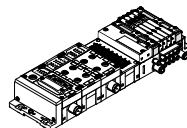

559751
en 1505a
[8036957]

Translation of the original instructions
P.BE-CPX-CMAX-SYS-EN

Interbus®, DeviceNet®, PI PROFIBUS PROFINET®, CC-Link®, EtherNET/IP®, Adobe Reader® and TORX® are registered trademarks of the respective trademark owners in certain countries.

Identification of hazards and instructions on how to prevent them:



Warning

Hazards that can cause death or serious injuries.



Caution

Hazards that can cause minor injuries or serious material damage.

Other symbols:



Note

Material damage or loss of function.



Recommendations, tips, references to other documentation.



Essential or useful accessories.



Information on environmentally sound usage.

Text designations:

- Activities that may be carried out in any order.
- 1. Activities that should be carried out in the order stated.
- General lists.

Table of Contents – CPX-CMAX-C1-1



Instructions on this documentation	6
Target group	7
Versions	7
Service	7
Product identification	8
Type codes	8
Documentation for the CPX terminal	9
1 Safety and requirements for product use	10
1.1 Safety	10
1.1.1 General safety information	10
1.1.2 Intended use	11
1.2 Requirements for product use	12
1.2.1 Transport and storage conditions	12
1.2.2 Technical prerequisites	12
1.2.3 Qualification of the specialists (requirements for the personnel)	12
1.2.4 Range of application and certifications	12
1.2.5 Permitted CPX bus nodes and control blocks	13
1.2.6 Festo Configuration Tool with plug-in for the CMAX	14
2 Product overview	15
2.1 Structure of a positioning system	15
2.2 Connection and display components	16
2.3 Function and application	16
2.3.1 Tasks of the CMAX	16
2.3.2 Mode of operation	16
2.3.3 General instructions on use of the CMAX	17
2.3.4 CMAX in the CPX terminal	17
3 Mounting and pneumatic installation	18
3.1 General instructions on mounting and installation	18
3.2 Dismantling and mounting CMAX	19
3.3 Mounting of the drive and displacement encoder	21
3.3.1 General requirements of the mechanical system	21
3.3.2 Drive, shock absorbers and fixed stops	23
3.3.3 External displacement encoders	23
3.3.4 Load	25
3.4 Proportional directional control valve VPWP	28
3.4.1 Approved drive/valve combinations	28
3.4.2 Mounting the VPWP proportional directional control valve	30

3.5	Mounting the CASM sensor interface	32
3.6	Pneumatic installation	33
3.6.1	Compressed air supply	33
3.6.2	Filter regulator	34
3.6.3	Air pressure reservoir (optional)	34
3.6.4	Proportional directional control valve VPWP and drive	34
3.6.5	Compressed air tubing and fittings	38
4	Electrical installation	39
4.1	Safety instructions	39
4.2	Earthing	40
4.3	Axis connection	41
4.3.1	Proportional directional control valve VPWP	42
4.3.2	Sensor interface CASM	43
4.4	Power supply	44
4.4.1	Determining the current consumption	44
4.4.2	Power supply concept, formation of power zones	45
5	Commissioning	48
5.1	Important notes on commissioning	48
5.2	Parameterisation and commissioning options	49
5.2.1	Communication profile FHPP	49
5.2.2	Festo Configuration Tool (FCT)	49
5.3	Preparations for commissioning	52
5.3.1	Checking the axis string	52
5.3.2	Switching on the supply voltage, switch-on behaviour	52
5.3.3	Make connection to the PC	54
5.4	Commissioning with the FCT (overview)	55
5.4.1	Overview of commissioning steps	55
5.5	Notes on operation	56
5.5.1	Control of the CMAX	56
5.5.2	General instructions on operation	56
6	Diagnostics and error handling	57
6.1	Summary of diagnostics options	57
6.2	Diagnostics via LEDs	58
6.2.1	CMAX-specific LEDs	59
6.2.2	Axis-specific LEDs	59
6.2.3	LEDs at the proportional directional control valve VPWP	60
6.2.4	LEDs at the sensor interface CASM	61
6.2.5	LEDs at the displacement encoder DGCI	61

6.3	Diagnostics via display	62
6.3.1	Error display	62
6.3.2	Status display	63
6.4	Faults and warnings	67
6.4.1	Effect on the sequence control and axis – malfunction step	67
6.4.2	Acknowledgement of faults and warnings – reset type	68
6.4.3	Illustration of CMAX error numbers in the CPX terminal	69
6.4.4	Error and warning numbers	70
6.5	Diagnostic functions with the CPX-MMI	89
6.5.1	Error display (menu [Diagnostics])	89
6.5.2	Information on the CMAX (menu [Module Data])	90
A	Technical appendix	91
A.1	Technical data CMAX	91
A.2	Replacement of components	94
A.3	Additional pneumatic circuits	95
B	Glossary	96
Index	98

Instructions on this documentation

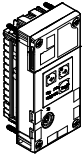
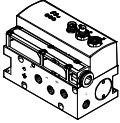
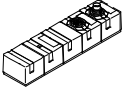
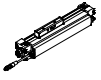
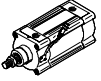
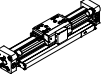
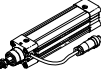
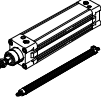
This description contains information on the functioning, mounting, installation and commissioning of the CPX-CMAX axis controller with the following modules and components of the positioning system (→ Tab. 1).

Module/component - type		Description
	CPX-CMAX-C1-1	Axis controller with 7-segments display and an axis connection to the proportional directional control valve VPWP. The axis controller – hereafter also called CMAX for short – is a CPX module (technology module) in a CPX terminal.
	VPWP-...	VPWP proportional directional control valve for connection of the pneumatic drive with connections to the CMAX and to the displacement encoder or sensor interface. In addition, it has a digital output and a voltage output for control of a brake or clamping unit.
	CASM-S-D2-R3 CASM-S-D3-R7	Sensor interfaces with connection to the VPWP for connecting special displacement encoders to the axis string: – analogue, absolute displacement encoders (potentiometer) – digital, incremental displacement encoders
Approved drives with displacement encoder ¹⁾		
	DDLI	– Linear drive with integrated displacement encoder (digital – absolute)
	DDPC	– Standard cylinder with integrated displacement encoder (incremental displacement encoder)
	DGCI	– Linear drive with permanently attached displacement encoder (digital – absolute)
	DNCI	– Standard cylinder with integrated displacement encoder (incremental displacement encoder)
	DNC with MLO-POT...LWG	– Standard cylinder with external displacement encoder (potentiometer – absolute)
	DSMI	– Semi-rotary drive with integrated displacement encoder (potentiometer – absolute)

1) Support for other drives in preparation

Tab. 1 Overview of modules and components of positioning system

Target group

This documentation is intended exclusively for technicians trained in control and automation technology, who have experience in installation, commissioning, programming and diagnostics of positioning systems.

Versions



This documentation refers to the following versions:

- CPX-CMAX-C1-1 with firmware V 2.2 and above.



Note

Before using a newer firmware version, check whether a newer version of the FCT plug-in or user documentation is available for it

(→ www.festo.com/sp, search term CPX-CMAX-C1-1).

Additional information on the version statuses → Help on the FCT-plug-in CMAX.

Service

Consult your regional Festo contact if you have any technical problems.

Product identification

Product label (example)	Significance					
<table border="1"> <tr> <td>CPX-CMAX-C1-1</td> </tr> <tr> <td>548932 X407</td> </tr> <tr> <td>Rev 08</td> </tr> <tr> <td>00000001502152</td> </tr> </table>	CPX-CMAX-C1-1	548932 X407	Rev 08	00000001502152	CPX-CMAX-C1-1	Type designation
	CPX-CMAX-C1-1					
	548932 X407					
	Rev 08					
	00000001502152					
548932	Part number					
X407	Production time period and plant					
Rev 08	Revision status					
00000001502152	14-character serial number					

Tab. 2 Product label CPX-CMAX-C1-1

Type codes

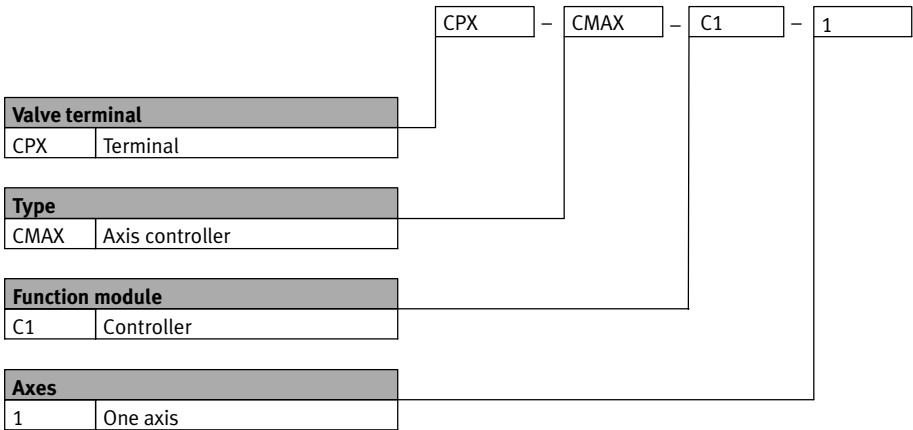

Fig. 1 Type codes

Documentation for the CPX terminal

General basic information about the mode of operation, mounting, installation and commissioning of CPX terminals → CPX system description, P.BE-CPX-SYS-... (→ www.festo.com/sp, search term CPX). Information about additional electronic modules from CPX → description on the respective electronics module. Overview of the structure of user documentation for the CPX terminal → CPX system description.

Documentation for CPX-CMAX-C1-1

Type	Title	Type	Contents
Electronics description	CPX-CMAX axis controller (system description)	P.BE-CPX-CMAX-SYS-...	<ul style="list-style-type: none"> – Mounting – Installation – Commissioning – Diagnostics
Communication profile description	FHPP for the CPX-CMAX axis controller	P.BE-CPX-CMAX-CONTROL-...	<ul style="list-style-type: none"> – Control – Programming – Diagnostics of a CMAX with the used CPX node
Software Help	Help for Festo Configuration Tool with CMAX plug-in		Configuration and commissioning of the CMAX axis controller with the FCT
Operating instructions	Operating instructions for the components used		

Tab. 3 Documentation for CPX-CMAX-C1-1



Electronic versions of the documentation for the CMAX axis controller in the Internet → www.festo.com/sp, search term CPX-CMAX-C1-1.

1 Safety and requirements for product use

1.1 Safety

1.1.1 General safety information



Warning

Danger from unexpected movement of the axis

Accidental movements of the connected actuators can cause collisions, with serious injuries. Dangerous movements due to incorrect control of connected actuators, for example caused by:

- untidy or faulty wiring/cabling
- errors in operating the components
- errors in the measured value and signal encoders
- defective or non-EMC-compliant components
- errors in the higher-order control system

Switching off the compressed air or load voltage is not a suitable locking method. In case of malfunction, drives can travel unintentionally.

- Before carrying out mounting, installation and maintenance work, place the system in a safe status (e.g. by placing the drive in a safe position and locking it).
- Make sure that no one enters the sphere of influence of the drives and actuators.
- Switch on the compressed air only when the system has been professionally installed and parameterised.
- Note that the controlled brake/clamping unit alone is not appropriate for personal protection.
- Provide additional support to protect vertical axes from falling or sliding down when the compressed air and load voltage are switched off, such as by:
 - mechanical locking of the vertical axis
 - external brake/clamping unit
 - sufficient counterbalance of the axis



Caution

Danger of injury due to incorrect handling of pressurised lines

Uncontrolled movements of the connected actuator technology and loose tubing can cause injury to persons and/or damage to property.

- Do not disconnect, open or cap pressurised lines.
- Exhaust lines before dismantling (release compressed air).
- Use suitable protective equipment (e.g. safety goggles, safety shoes).



Note

Damage to the product from incorrect handling.

- Switch off the supply voltage before mounting and installation work. Switch on supply voltage only when mounting and installation work are completely finished.
- Never unplug or plug in the product and components attached to the axis connection when powered!
- Observe the handling specifications for electrostatically sensitive devices.



1.1.2 Intended use

The CPX-CMAX-C1-1 is intended to serve as a position controller for location and force control of pneumatic drives. Operation is permitted only in combination with:

- an appropriate CPX bus node or control block (→ Section 1.2.5)
- components approved for this purpose on the axis string (→ Chapter 3)

The product is intended for use in industrial environments. Outside of industrial environments, e.g. in commercial and mixed-residential areas, actions to suppress interference may have to be taken. The CPX-CMAX-C1-1 is intended exclusively for use in CPX terminals from Festo for installation in machines or automated systems.

Use exclusively:

- in perfect technical condition
- In original condition, without unauthorised modifications
- within the limits of the product defined by the technical data (→ Appendix A.1)
- in an industrial environment



Note

In the event of damage caused by unauthorised manipulation or other than intended use, the guarantee is invalidated and the manufacturer is not liable for damages.

1.2 Requirements for product use

- Make this documentation available to the design engineer, installer and person responsible for commissioning of the machine or system in which this product will be used.
- Always comply with the specifications of the documentation. Also consider the documentation for the other components and modules.
- Take into consideration the legal regulations applicable for the location as well as:
 - regulations and standards
 - regulations of testing organisations and insurers
 - national specifications

1.2.1 Transport and storage conditions

- Protect the product during transport and storage from excessive stress factors, such as:
 - mechanical loads
 - impermissible temperatures
 - moisture
 - aggressive atmospheres
- Store and transport the product in its original packaging. The original packaging offers sufficient protection from typical stresses.

1.2.2 Technical prerequisites

General conditions for the correct and safe use of the product, which must be observed at all times:

- Comply with the connection and ambient conditions of the product and all connected components specified in the technical data. Technical data of the product → Appendix A.1. The product can only be operated in compliance with the relevant safety regulations if you comply with the limit values and load limits.
- Observe the notes and warnings in this documentation.

1.2.3 Qualification of the specialists (requirements for the personnel)

The product may only be placed in operation by a qualified electrotechnician who is familiar with:

- Installation and operation of electrical control systems
- the applicable regulations for operating safety-engineered systems
- the applicable regulations for accident prevention and occupational safety and
- the documentation for the product

1.2.4 Range of application and certifications

Test values, which the product must comply with and fulfil → Technical data in appendix A.1. Product-relevant EC directives → Declaration of conformity.



For certificates and the declaration of conformity for this product → www.festo.com/sp.

Specified standards

Version status	
EN 60204-1:2006-06/A1:2009-02	ISO 8573-1:2010

Tab. 1.1 Standards specified in the document

1.2.5 Permitted CPX bus nodes and control blocks

The following CPX bus nodes and control blocks are approved for operation with the CMAX axis controller starting with the revisions named here (at the time this description was printed). Older revisions are not supported and can lead to unpredictable behaviour.



Current information on this → catalogue from Festo (→ www.festo.com/catalogue).

Observe the notes on the software status in the documentation for the bus node or control block.

Bus node/ control block	Protocol	Approved revision ¹⁾	Max. number ²⁾ CMAX
CPX-CEC	(Control block)	Revision 5 and above	8
CPX-FEC		Revision 19 (R19) and above	8
CPX-CEC-C1		Revision 7 (R7) and above	8
CPX-CEC-M1		Revision 3 (R3) and above	8
CPX-FB6	Interbus	Revision 22 (R22) and above	1
CPX-FB11	DeviceNet	Revision 20 (R20) and above	8
CPX-FB13	PROFIBUS-DP	Revision 23 (R23) and above	8, 7 ³⁾
CPX-FB14	CANopen	Revision 20 (R20) and above	4
CPX-M-FB20	Interbus	Revision 2 (R2) and above	1
CPX-M-FB21	Interbus	Revision 2 (R2) and above	1
CPX-FB23-24	CC-Link (function module F23)	Revision 19 (R19) and above	4
	CC-Link (function module F24)		8
CPX-FB32	EtherNet/IP	Revision 14 (R14) and above	8
CPX-FB33	PROFINET	Revision 7 (R7) and above	8
CPX-M-FB34		Revision 7 (R7) and above	8
CPX-M-FB35		Revision (R20) and above	8
CPX-FB36		EtherNet/IP	Revision 5 (R5) and above
CPX-FB38	EtherCAT	All	8

1) Revision status (Rev...) → Product label.

2) The maximum number within a CPX terminal can be further restricted through the available address range.

3) If acyclic services (DPV1) are used, a maximum of 7 CMAX modules are permitted.

Tab. 1.2 Required revisions

1.2.6 Festo Configuration Tool with plug-in for the CMAX

The Festo Configuration Tool (FCT) is the software platform for configuring and commissioning the CMAX.



FCT with plug-in for the CMAX → www.festo.com/sp, search term: CMAX.

2 Product overview

2.1 Structure of a positioning system

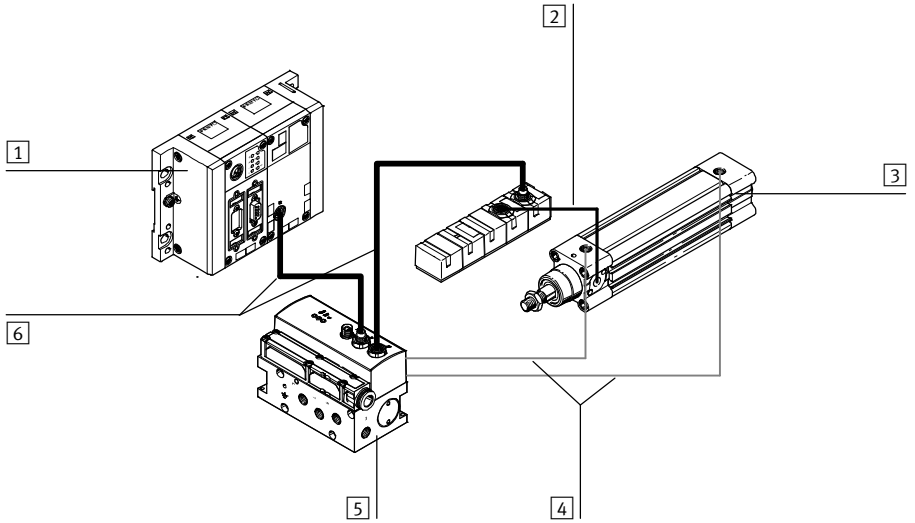

- | | | | |
|----------|---|----------|---------------------------------|
| 1 | CPX terminal with CPX-CMAX-C1-1 | 3 | Drive with displacement encoder |
| 2 | Sensor interface with connecting cable
(optional, depending on the displacement
encoder used) | 4 | Pneumatic tubing |
| 5 | Proportional directional control valve VPWP | 6 | Axis string |

Fig. 2.1 Structure of a positioning system with CPX-CMAX-C1-1 – example

2.2 Connection and display components

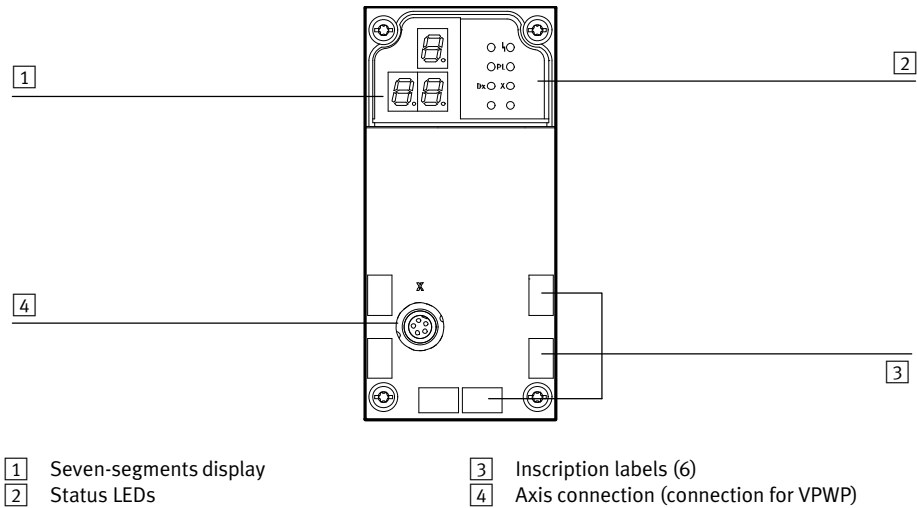

Fig. 2.2 Control section and connections CPX-CMAX-C1-1

2.3 Function and application

2.3.1 Tasks of the CMAX

The CMAX takes over the following functions:

- storage of all project parameters (e.g. hardware configuration, records, controller settings)
- determination of system characteristic values of the connected components (identification)
- specification of the setpoint values (position or force) calculated from the specified target value and the parameterised movement profile
- tracking of the actual value (position or force control) in case of deviation through corresponding control of the proportional directional control valve

2.3.2 Mode of operation

The CMAX, valve, drive and displacement encoder are connected with each other to form a closed-loop. In combination with a proportional directional control valve VPWP and a drive with a displacement encoder, the CMAX axis controller forms a positioning system for pneumatic axes (→ Section 1.2). The positioning system permits the following:

- travel at selectable speed with previously configured acceleration in any positions (position control)
- application of a defined force with configured force edge [N/s] (force control) with simultaneous speed and position monitoring

2.3.3 General instructions on use of the CMAX

Fundamentals for planning and execution of positioning systems with CMAX

In the CPX terminal, a maximum of 8 CMAX modules are permitted - dependent on the bus node (→ Tab. 1.2).

The maximum permitted length (total) of the used connecting cables KVI-CP-3-... of the axis string is 30 m (total length CMAX – VPWP – sensor interface or displacement encoder; → Fig. 2.1).

- Attach drive backlash-free to the application and displacement encoder.
- Comply with minimum load (→ Section 3.3.4).
- Comply with requirements for compressed air supply (→ Section 3.6.1 and 3.6.2)
- Take into account emergency stop processing of an axis from the start (additional pneumatic circuitry → A.3).
- Always select tubing between cylinder and VPWP valve to be as short as possible. A tube length of 60 % of the cylinder stroke length is optimal (max. tube length = cylinder stroke length).
- Avoid elbow connectors as much as possible. Elbow connectors reduce the flow by up to 30 %. This reduces the possible top speed and maximum acceleration.
- Take into account power requirements of the components used. For example, the max. current consumption of the valve VPWP is up to 1.35 A (valve drive 1.2 A, logic 0.15 A) - without current consumption for the optionally usable outputs (→ Section 4.4.1).

To achieve good positioning behaviour:

- Feed compressed air at the cylinder on both sides.
- Comply with stroke reduction in accordance with the catalogue specifications.

Stroke reduction is 10 ... 35 mm per side – dependent on the cylinder (→ www.festo.com/catalogue).

Tip: The best positioning behaviour is achieved when only 80 % of the cylinder stroke is used and 10 % remains on each side as reserve.

The CMAX is not suitable for:

- cylinder lengths > 2000 mm
- cylinder lengths > 50 mm
- repetition accuracy < ±0.2 mm
- speeds < 30 mm/s
- positioning strokes < 10 mm
- force values that lie underneath the friction of the system

2.3.4 CMAX in the CPX terminal

The CMAX is integrated into a CPX terminal as a CPX module and is controlled by the CPX bus node or control block via the internal bus using 8-byte module output data and 8-byte module input data.



Information on control and parameterisation of the CMAX over the CPX node
→ Communication profile description, P.BE-CPX-CMAX-CONTROL-... .

3 Mounting and pneumatic installation

3.1 General instructions on mounting and installation



When mounting the components, observe also the mounting instructions in the accompanying operating instructions and the notes on installation in this chapter. Only then can you guarantee trouble-free operation. Information about mounting of the CPX terminal
 → CPX system description (P.BE-CPX-SYS-...).



Note

Malfunctions due to impermissible components

The use of components that have not been approved for operation with the CMAX may cause malfunctions.

- Use only the special matching components from Festo for setting up and wiring the system.

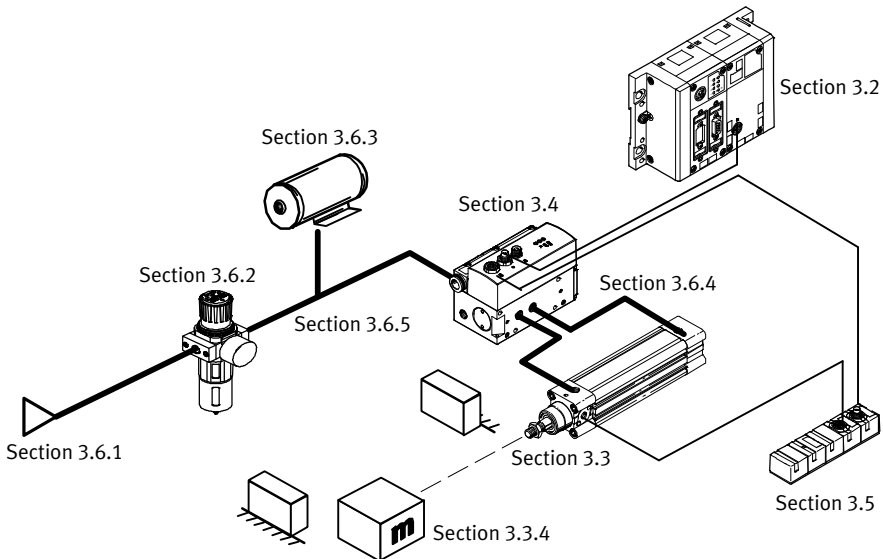

Fig. 3.1 Overview of mounting and pneumatic installation

3.2 Dismantling and mounting CMAX

The CMAX is mounted in an interlinking block (→ Section 4.4) of the CPX terminal (→ Fig. 3.2).



Note

Damage to the product from incorrect handling.

- Switch off the supply voltage before mounting and installation work. Switch on supply voltage only when mounting and installation work are completely finished.
- Never push/pull the electronics module into/out of the interlinking block when under power!



Note

The CMAX contains electrostatically sensitive devices. Electrostatic discharge caused by improper handling or incorrect earthing can damage components.



- Do not touch any components.
- Observe the handling specifications for electrostatically sensitive devices.

Dismantling CMAX

1. Switch off the operating and load voltage supplies.
2. Unscrew 4 CMAX screws using a TORX screwdriver, size T10.
3. Pull CMAX carefully and without tilting away from the contact rails of the interlinking block.

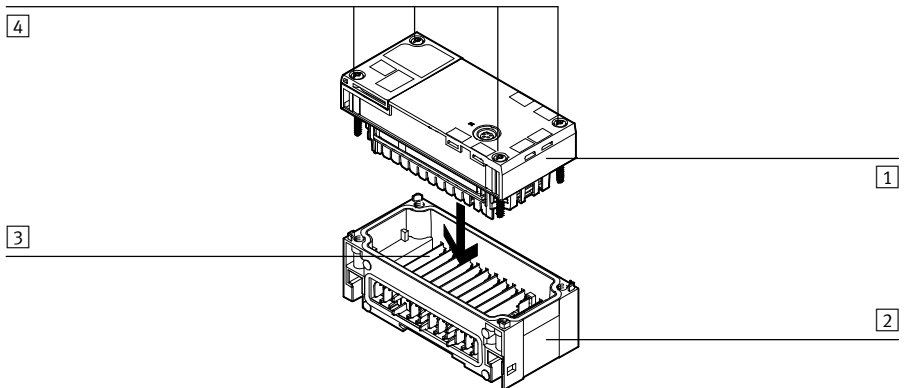

- 1 CMAX
- 2 Interlinking block

- 3 Contact rails
- 4 Torx T10 screws

Fig. 3.2 Dismantling/mounting the CMAX

Mounting CMAX



Note

Always use the correct screws for the interlocking block, which depend on the material the block is made of (metal or plastic). Both types of screws are enclosed when the CPX-CMAX is ordered as a single part.

- for plastic interlinking blocks: self-tapping screws
- for metal interlinking blocks: screws with metric thread

1. Check seal and seal surfaces.
2. Insert CMAX correctly positioned into the interlinking block. The corresponding slots with the power contact terminals on the bottom of the CMAX must lie above the contact rails.
3. Push the CMAX carefully and without tilting into the interlinking block up to the stop.
4. Screws must be set so that the available self-cutting threads can be used. Then tighten all four screws in diagonally opposite sequence with a Torx screwdriver size T10 – tightening torque 0.9 ... 1.1 Nm.



The parameterisation is saved in the CMAX. After replacing a CMAX, check the parameters and perform commissioning again (→ Chapter 5). Observe the instructions in appendix A.2.

3.3 Mounting of the drive and displacement encoder



Note

In order to avoid damage due to uncushioned movement into the end positions:

- Use appropriate shock absorbers.
- Determine software end positions.

To avoid damage to the displacement encoder when the displacement encoder is shorter than the stroke of the drive:

- Limit the movement range by means of additional end stops.

The following drives are approved starting with firmware V 2.2 for operation with the CMAX axis controller (at the time of printing):

Drive Type	Design	Displacement encoder		Sensor interface
DDLI	Linear drive	Integrated	Digital (absolute)	– ¹⁾
DDPC	Standard cylinder	Integrated	Incremental	CASM-S-D3-R7
DGCI	Linear actuator	Permanently attached at the factory	Digital (absolute)	– ¹⁾
DNCI	Standard cylinder	Integrated	Incremental	CASM-S-D3-R7
DNC ²⁾		External, MLO-POT-LWG..	Potentiometer (absolute)	CASM-S-D2-R3
DSMI	Semi-rotary drive	Integrated	Potentiometer (absolute)	

1) Not required

2) The slow speed variant S10, low friction variant S11, temperature resistant variant S6 are not permitted (only on request). Use only DNC variants with permissible max. piston speed $V_{max} > 1$ m/s.

Tab. 3.1 Permissible drives



Additional drives are in development.

Current information → www.festo.com/catalogue.

3.3.1 General requirements of the mechanical system



Note

Machine parts that tend to oscillate and mechanical play, e.g. between the cylinder piston rod and the load to be moved, result in poor movement behaviour. Oscillations and mechanical play confront the controller with “constantly changing loads”.

- Fasten the axis to appropriate machine parts that are as rigid as possible.
- Connect the drive, guide, displacement encoder and load **as free of play as possible** and align them flush with each other.

Important for positioning accuracy:

- The cylinder, guide, measuring system and load must be rigid in the direction of movement, have very little play and must be connected flush with each other.
- The play between the drive, guide, load and displacement encoder must be smaller by at least the factor 10 than the required tolerance. The play should be < 0.1 mm.



Note

Lateral loadings produce false measuring results and may damage the displacement encoder.

- Use an external guide for the payload in order to prevent transverse loadings on the drive.

- Use fastening elements which will permanently resist the forces of acceleration.
- If necessary, provide a sufficiently large energy chain in order to minimise the effects of bending forces on the positioning behaviour.



Note

Observe the notes in the operating instructions for the axis used.

- Ensure that the following is complied with:
 - the permissible transverse force
 - the permissible longitudinal force
 - the permitted mass moment of inertia
 - the maximum permissible speed and swivel frequency

Notes on coupling (piston rod drive)

If a coupling is required between the piston rod and the guide:

- Check the play of the coupling.
The requirement is: coupling play ≤ 0.05 mm
- Set the play of the coupling correspondingly.



Too much coupling play leads to:

- noise due to knocking on the coupling
- increased wear on the coupling
- worse operating behaviour

Make sure that the coupling play does not exceed 0.05 mm.

3.3.2 Drive, shock absorbers and fixed stops

Drive



Note

- With all drives, follow the notes on mounting in the operating manual.

- Use only permissible drives and drive-displacement encoder combinations with suitable guides (→ Tab. 3.1). Use other drives only after consultation with Festo.
- Comply with stroke reduction in accordance with the catalogue specifications on every side of the drive. Stroke reduction is 10 ... 35 mm per side – dependent on the drive (→ www.festo.com/catalogue).

Tip: The best positioning behaviour is achieved when only 80 % of the drive's stroke length is used and 10 % remains on each side as reserve.

In addition, for standard cylinders with end-position cushioning PPV:

- Completely unscrew the adjustment screws for the end-position cushioning (PPV) on both sides.

Shock absorbers/fixed stops

Shock absorbers or fixed stops may be recommended, depending on the application and drive used.

These fulfil the following functions:

- protection of the drive or displacement encoder
- determination of the end positions



Note

Damage due to uncushioned travel into the end positions.

- Carry out commissioning again if the fixed stops have been adjusted or components and hoses have been replaced.

- Recommendation: Use appropriate external stops, shock absorbers or fixed stops from Festo.



Information on mounting the shock absorbers and fixed stops from Festo → Operating instructions for the drive or mounting instructions for the shock absorbers or fixed stops.

3.3.3 External displacement encoders



Note

If the positioning range of the drive is longer than the working stroke of the measuring system:

- Limit the positioning range by means of shock absorbers or stops so that the measuring system covers the complete possible positioning range. This protects the displacement encoder from damage.

Mounting instructions for the displacement encoder MLO-POT-...

- Always mount the displacement encoder and cylinder symmetrically, if possible (middle of the measuring system stroke must match the middle of the entire cylinder stroke).

For the displacement encoder MLO-POT-..., an electrical reserve of $\geq 0.3\%$ of the nominal length is required in both end positions so that a wire break or defective wiper can be detected (already taken into account with the integrated potentiometer of the DSMI).

Example:

Nominal length of the displacement encoder: 1000 mm; electrical effective length: approx. 1006 mm

→ Permitted work path: 0 ... 1000 mm

If the displacement encoder slide leaves the permitted work path, the CMAX generates a corresponding error message. To avoid these error messages:

- Limit the positioning range so that the displacement encoder slide is always within the permitted work path.

3.3.4 Load

For good positioning behaviour, the CMAX must be adjusted to the load. The total load represents the complete load to be moved with the positioning drive, including the weight of the piston and the slide. The total load consists of the following:

Load	Description
Base load	Total of all loads/mass moment of inertia of moved components that are permanently connected to the piston rod/rotary vane or the drive slide of the cylinder/semi-rotary drive and cannot be changed (e.g. piston/piston rod and slide, workpiece gripper or gripper unit).
Payload	An additionally moved load of a workpiece or of the load to be transported which, compared to the constantly present base load, is moved only when the axis is loaded. With semi-rotary drives, the payload equals the mass moment of inertia (MMI) of the workpiece related to the axis of rotation (MMI of the payload in kgcm ²). If the payload is permanently connected to the drive, the load can also be added to the base load. The payload is then set to zero.

Tab. 3.2

There is a maximum and a minimum permissible total load. The permitted mass load depends on the:

- drive type
- drive diameter
- mounting position
- operating pressure
- Make sure that the effective total load in all load situations:
 - is not less than the minimum permissible total load. This applies in particular for the load without payload (→ Tab. 3.3 and Tab. 3.5).
 - does not exceed the maximum permissible total load (→ Tab. 3.3 and Tab. 3.5).



Note

A pneumatic positioning axis should be operated with at least the minimum total load (→ www.festo.com/catalogue). If necessary, this minimum mass load must be ensured through the use of an additional weight.

The payload present can be specified for each positioning command. The controller setting of the CMAX can thus be adjusted to various loads.



Note

If the total load varies from positioning command to positioning command, e.g. due to changing workpieces, the payload should be adapted in the positioning command. For additional information → Communication profile description, P.BE-CPX-CMAX-CONTROL-....

Total load for linear drives and piston rod cylinders

- Determine the permitted total load based on Tab. 3.3.

Mounting position	Maximum total load	Minimum total load
Horizontal ($\alpha = 0^\circ$)	m_{\max}	$0.1 * m_{\max}$
Vertical ($\alpha = 90^\circ$)	$0.33 * m_{\max}$	$0.1 * m_{\max}$
Diagonal ($0^\circ < \alpha < 90^\circ$)	$(1 - 2/3 \sin \alpha) * m_{\max}$	$0.1 * m_{\max}$
a = Mounting position in [°] m_{\max} = $d^2 * p_{\text{sys}} * 0.008$ (maximum total load for horizontal mounting position [kg]) d = Cylinder diameter [mm] p_{sys} = Supply pressure [bar]		

Tab. 3.3 Maximum and minimum total load

Example: load for DNCI-32 with $p = 6$ bar

Mounting position	Maximum total load	Minimum total load
Horizontal ($\alpha = 0^\circ$)	$m_{\max} = 32^2 * 6 * 0.008 = 49.15 \text{ kg}$	$0.1 * m_{\max} = 4.92 \text{ kg}$
Vertical ($\alpha = 90^\circ$)	$0.33 * m_{\max} = 16.22 \text{ kg}$	$0.1 * m_{\max} = 4.92 \text{ kg}$
Diagonal (45°)	$(1 - 2/3 \sin 45^\circ) * m_{\max} = 25.98 \text{ kg}$	$0.1 * m_{\max} = 4.92 \text{ kg}$

Tab. 3.4 Example total load

Note on mounting

- Mount the load so that it is free of play.
- Check whether a guide is required.

Mass moments of inertia for semi-rotary drives

Permitted mass moments of inertia for the semi-rotary drive DSMI in electronically regulated operation with the CMAX are shown in the following table:

Semi-rotary drive	Permitted mass moment of inertia [10^{-4} kgm^2]
DSMI-25-...	15 ... 300
DSMI-40-...	60 ... 1200
DSMI-63-...	300 ... 6000

Tab. 3.5 Permitted mass moment of inertia



Festo supports calculation of the mass moment of inertia with software for calculation of mass moments of inertia of the second degree for various basic bodies and standard parts from Festo – e.g. push-on flange for DSMI (→ www.festo.com/sp, search term: mass moment of inertia (Mass moment of inertia)).



Note
 Natural oscillations of the load can lead to malfunctions.

- Fasten the load so that vibration is kept to a minimum.
- Avoid loads on long, flexible lever arms.

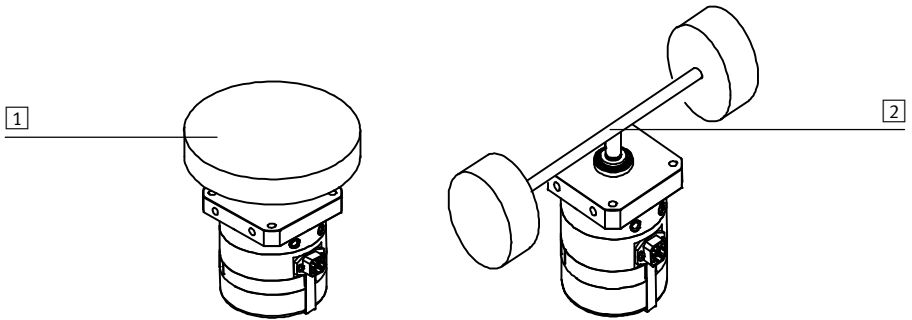

1 Favourable internal vibration behaviour

2 Unfavourable internal vibration behaviour

Fig. 3.3 Example: favourable and unfavourable internal vibration behaviour of the load

Mounting position for semi-rotary drives

The mass moment of inertia must not change during the movement. And so the following apply for the mounting position, dependent on the load:

- load centre of mass in the axis of rotation, load rotation-symmetrical:
 → any mounting position permitted.
- load centre of mass in the axis of rotation, load not rotation-symmetrical:
 → only vertical mounting position permitted, drive shaft points upward (→ Example Fig. 3.3) or downward.
- load centre of mass outside the axis of rotation (not recommended):
 → only vertical mounting position permitted, drive shaft points upward or downward.

3.4 Proportional directional control valve VPWP

3.4.1 Approved drive/valve combinations

Tab. 3.6 contains the approved drive-valve combination at the time this description was printed.

- Use the specified fittings and compressed air tubing or appropriate hoses with corresponding flow rates.



Current information → www.festo.com/catalogue.

Drive Type	Size	Length [mm]	Valve	Fitting		Compressed air tubing	
				Valve	Drive		
DDLI	25	100 ... 160	VPWP-4-...	QS-G1/8-6	QS-G1/8-6	PUN-6x1	
		225 ... 600		QS-G1/8-8	QS-G1/8-8	PUN-8x1,25	
		750 ... 2000	VPWP-6-...				
	32	100	VPWP-4-...	QS-G1/8-6	QS-G1/8-6	PUN-6x1	
		160 ... 360		QS-G1/8-8	QS-G1/8-8	PUN-8x1,25	
		450 ... 2000	VPWP-6-...				
	40	100 ... 300	VPWP-4-...	QS-G1/8-8	QS-G1/4-8	PUN-8x1,25	
		360 ... 750	VPWP-6-...				
		850 ... 2000	VPWP-8-...	QS-G1/4-10	QS-G1/4-10	PUN-10x1,5	
	63	100 ... 300	VPWP-6-...	QS-G1/8-8	QS-G3/8-8	PUN-8x1,25	
		360 ... 450	VPWP-8-...	QS-G1/4-10	QS-G3/8-10	PUN-10x1,5	
		500 ... 750			QS-G3/8-12 ²⁾		
		850 ... 2000	VPWP-10-...	QS-G3/8-12	QS-G3/8-12	PUN-12x2	
	DDPC	80	100 ... 200	VPWP-6-...	QS-G1/8-8	QS-G3/8-8	PUN-8x1,25
			201 ... 450	VPWP-8-...	QS-G1/4-10	QS-G3/8-10	PUN-10x1,5
451 ... 750			VPWP-10-...	QS-G3/8-12	QS-G3/8-12	PUN-12x2	
100		100 ... 120	VPWP-6-...	QS-G1/8-8	QS-G1/2-12 ¹⁾	PUN-8x1,25	
		121 ... 330	VPWP-8-...	QS-G1/4-10	QS-G1/2-12 ²⁾	PUN-10x1,5	
		331 ... 750	VPWP-10-...	QS-G3/8-12	QS-G1/2-12	PUN-12x2	
DGCI	18	100 ... 2000	VPWP-4-...	QS-G1/8-6	QSM-M5-6	PUN-6x1	
	25	100 ... 160	VPWP-4-...	QS-G1/8-6	QS-G1/8-6		
		225 ... 600		QS-G1/8-8	QS-G1/8-8	PUN-8x1,25	
		750 ... 2000	VPWP-6-...				
	32	100 ... 400	VPWP-4-...	QS-G1/8-8	QS-G1/8-8	PUN-8x1,25	
450 ... 2000		VPWP-6-...					

1) With additional reduction from $\varnothing 12$ to $\varnothing 8$, with push-in connector QS-12H-8

2) With additional reduction from $\varnothing 12$ to $\varnothing 10$, with push-in connector QS-12H-10

Drive			Valve	Fitting		Compressed air tubing
Type	Size	Length [mm]		Valve	Drive	
DGCI	40	100 ... 300	VPWP-4-...	QS-G1/8-8	QS-G1/4-8	PUN-8x1,25
		360 ... 750	VPWP-6-...		QS-G1/4-8	
		850 ... 2000	VPWP-8-...	QS-G1/4-10	QS-G1/4-10	PUN-10x1,5
	63	100 ... 300	VPWP-6-...	QS-G1/8-8	QS-G3/8-8	PUN-8x1,25
		360 ... 750	VPWP-8-...	QS-G1/4-10	QS-G3/8-10	PUN-10x1,5
		850 ... 2000	VPWP-10-...	QS-G3/8-12	QS-G3/8-12	PUN-12x2
DNC(I)	32	50 ... 150	VPWP-4-...	QS-G1/8-6	QS-G1/8-6	PUN-6x1
		151 ... 400		QS-G1/8-8	QS-G1/8-8	PUN-8x1,25
		> 401	VPWP-6-...			
	40	50 ... 250	VPWP-4-...	QS-G1/8-8	QS-G1/4-8	PUN-8x1,25
		> 251	VPWP-6-...			
	50	50 ... 180	VPWP-4-...	QS-G1/8-8	QS-G1/4-8	PUN-8x1,25
		181 ... 600	VPWP-6-...			
		> 601	VPWP-8-...	QS-G1/4-10	QS-G1/4-10	PUN-10x1,5
	63	50 ... 100	VPWP-4-...	QS-G1/8-8	QS-G3/8-8	PUN-8x1,25
		101 ... 350	VPWP-6-...		QS-G3/8-10	PUN-10x1,5
		> 351	VPWP-8-...	QS-G1/4-10		
	DSMI	25	– (270°)	VPWP-4-...	QS-G1/8-6	QSM-M5-6
40		– (270°)	QS-G1/8-8		QS-G1/8-8	PUN-8x1,25
63		– (270°)			QS-G1/4-8	

Tab. 3.6 Drive/valve combinations

3.4.2 Mounting the VPWP proportional directional control valve

- Attach the VPWP as close to the drive as possible according to one of the following alternatives.

VPWP-4/-6/-8

- a) Mounting on an even surface with two M3 screws and one retaining washer each
The tightening torque is $1.5 \text{ N} \pm 10 \%$.

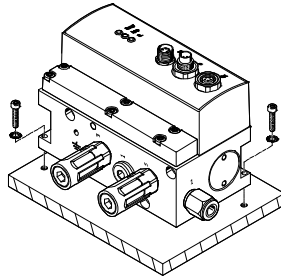

Fig. 3.4

- b) Mounting on the side with 4 M4 screws
The tightening torque is $3 \text{ Nm} \pm 10 \%$.

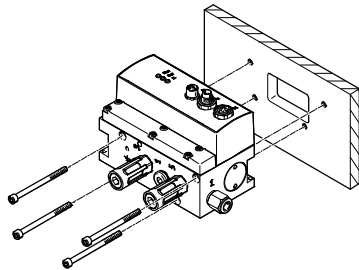

Fig. 3.5

- c) Mounting to an H-rail (DIN mounting rail size TH35)
Depending on the size of the VPWP, the following attachment is required (→ www.festo.com/catalogue):

- VPWP-4/-6: CPASC1-BG-NRH
- VPWP-8: CPV10/14-VI-BG-NRH-35

1. Ensure that the mounting surface can carry the weight of the VPWP.
2. Mount H-rail. Be sure to leave sufficient space for connecting the supply cables and tubes.

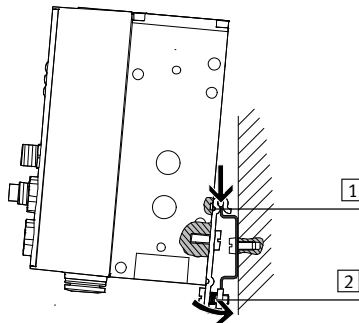

Fig. 3.6

3. Screw mounting clips to the VPWP with the accompanying screws – tightening torque 1.5 Nm . Make sure that the fixing bolts (1) of the clips grip into the groove of the VPWP.
4. Hang the VPWP on the H-rail. Secure against tipping or slipping by using the H-rail clamping (2).

VPWP-10

With VPWP-10, H-rail mounting is not intended.

- Mounting on an even surface with two M6 bolts.
The tightening torque is 9 Nm \pm 10 %.

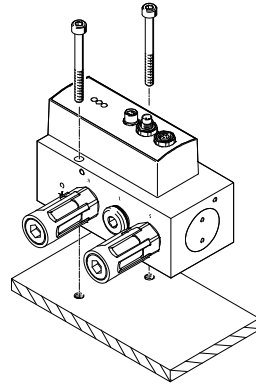

Fig. 3.7 Mounting VPWP-10

When mounting onto moving parts

- Always mount the VPWP perpendicular to the direction of movement. Acceleration forces thus have no influence on the valve slide setting.

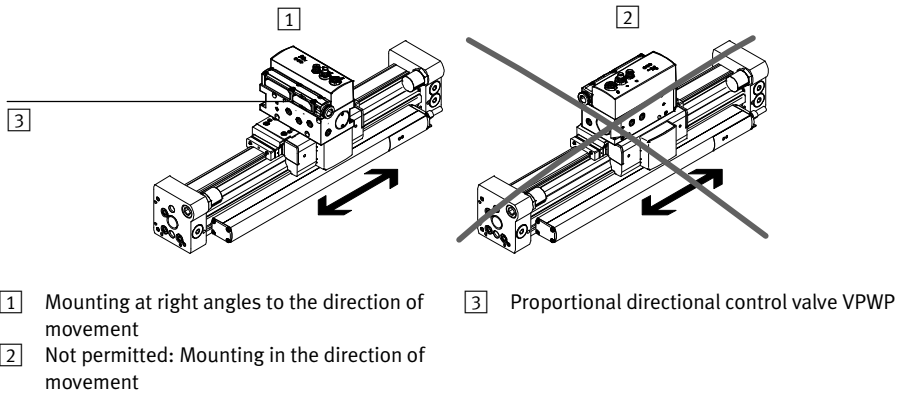

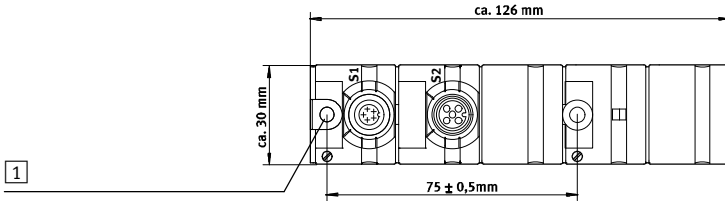

Fig. 3.8 Mounting the VPWP onto moving parts

3.5 Mounting the CASM sensor interface

- Mount the CASM-... sensor interface on an even surface with two M4 screws and one retaining washer each (→ Fig. 3.9).
The symbol  below the slot for inscription labels identifies the position of the mounting screws.
The outer fastening screw serves at the same time for earthing (). The tightening torque is 2 Nm.



 Mounting screw (connect earthing)

Fig. 3.9 Mounting CASM

Mounting on H-rails of size TH35 is possible with mounting kit CP-TS-HS35 (→ Fig. 3.10).

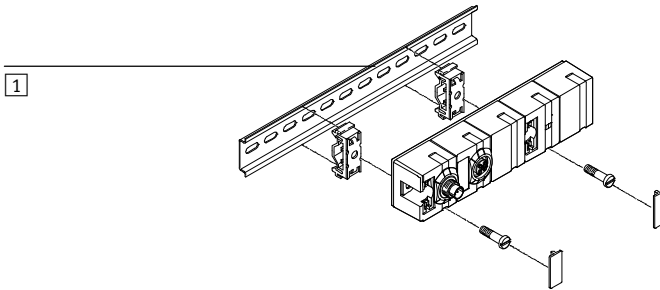

 H-rail

Fig. 3.10 Mounting CASM on H-rail

3.6 Pneumatic installation



Note

To ensure trouble-free operation:

- Observe the following notes on pneumatic installation.

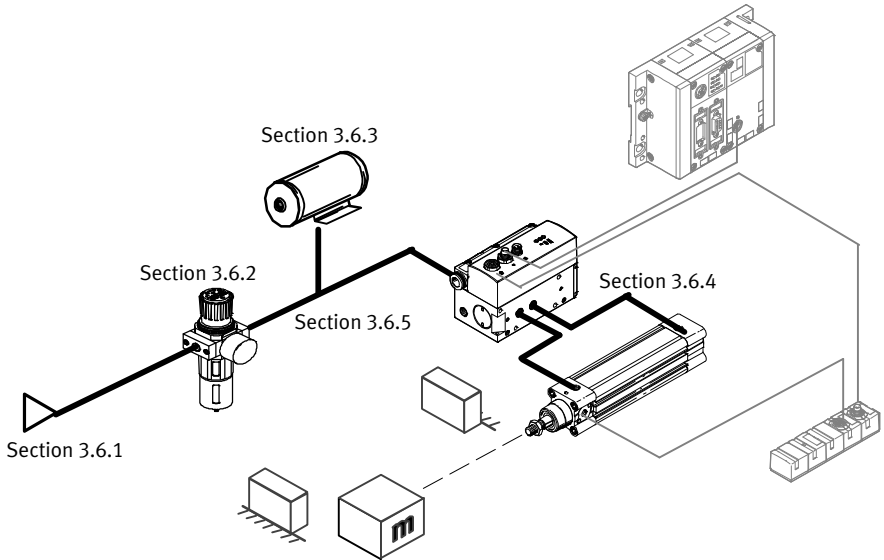

Fig. 3.11 Overview of pneumatic installation

3.6.1 Compressed air supply

Requirements of the compressed air supply:

- Required operating medium: compressed air in accordance with ISO 8573-1:2010 [6:4:4] (→ www.festo.com/catalogue as well as brief description on the proportional directional control valve VPWP)
- Permissible pressure range: 4 ... 8 bar.

For good positioning behaviour during a positioning operation, fluctuations in pressure of max. 1 bar are permitted in front of the proportional directional control valve. To check the stability of the supply pressure as needed:

- Install a pressure measuring point directly in front of the proportional directional control valve.

To obtain results in force control that are as good as possible, the configured supply pressure should correspond to the medium available supply pressure (→ FCT plug-in; page [Application data] “master data”).

3.6.2 Filter regulator

- Use a filter regulator consisting of a compressed air filter and regulating valve (e.g. LFR-...-D-... with 5 µm filter cartridge):
 - without lubricator
 - with a 5 µm filter
 - with sufficiently large standard nominal flow rate corresponding to the air volume requirements of the connected drive during positioning (reference value: 2 times the standard nominal flow rate of the proportional directional control valve VPWP), e.g.:

Valve (fitting)	Filter regulator
VPWP-4-... (1/8)	LFR-1/8-D-5M-MINI or MS4-LFR-1/4-D7-CRM-AS
VPWP-6-... (1/8)	LFR-1/4-D-5M-MINI or MS4-LFR-1/4-D7-CRM-AS
VPWP-8-... (1/4)	LFR-3/8-D-5M-MIDI or MS6-LFR-1/4-D7-CRM-AS
VPWP-10-... (3/8)	LFR-3/4-D-5M-MAXI or MS6-LFR-3/8-D7-CRM-AS

Tab. 3.7 Selection of filter regulator

- Use a fine or micro filter if you cannot avoid a slight oil mist from the compressed air supply.
- Combine the filter regulator with a soft-start valve (e.g. HEL).

3.6.3 Air pressure reservoir (optional)

If the positioning behaviour does not conform to your requirements and fluctuations in pressure of over 1 bar are present at the pressure measuring point:

- Install an air pressure reservoir (e.g. CRVZS) between the filter regulator and the proportional directional control valve.

This avoids pressure fluctuations during positioning operation. You can compensate for slight excesses in the permitted pressure by using supply tubing with a larger diameter.

Volumes of the air pressure reservoir

The volume of the air pressure reservoir should be at least four times as large as the volume of the drive used.

$$V_S = 4 * V_Z$$

V_S = Volume of the air pressure reservoir

V_Z = Cylinder volume (linear drives: $V_Z = r^2 * \pi * L_Z$)

L_Z = Cylinder stroke length

r = $1/2 * \text{cylinder diameter}$

$\pi \approx 3.14159$

3.6.4 Proportional directional control valve VPWP and drive

Arrange the tubing between the valve (VPWP) and the drive symmetrically.



Recommendation for linear drives:

Always select tubing between cylinder and VPWP valve to be as short as possible. A tube length of 60 % of the cylinder stroke length is optimal (max. tube length = cylinder stroke length).

The proportional directional control valves VPWP-4/-6/-8 with characteristic Q6/Q8/Q10 (mounted fitting) possess from the factory a blue releasing ring at working port 2 and a black releasing ring at working port 4. Fig. 3.12 shows a schematic view of the tubing between a cylinder (example) and the VPWP. Tab. 3.8 shows the correct assignment of the ports of all permitted drives.

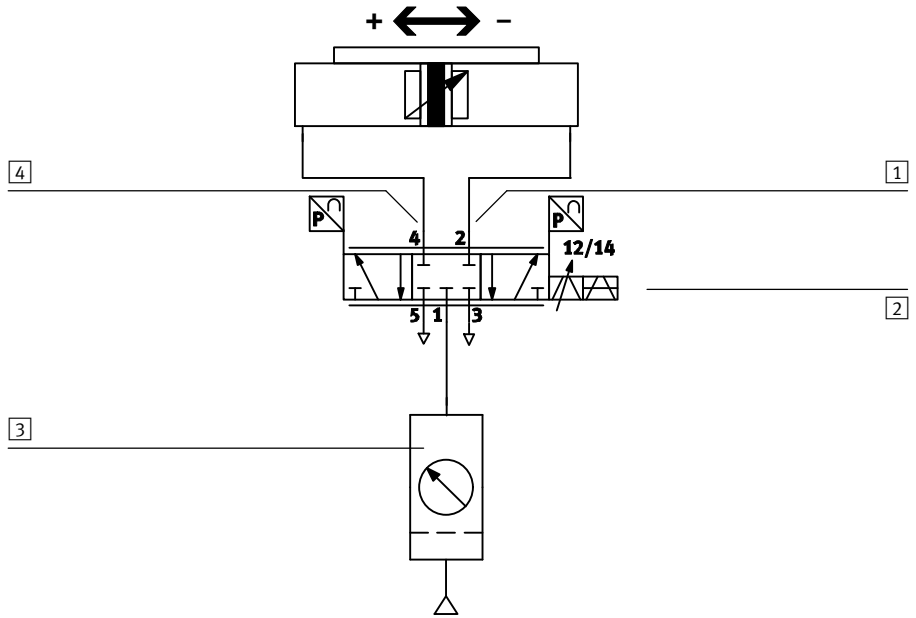

- | | |
|---|--|
| <p>1 Working port 2 (blue releasing ring):
→ Drive moves in the positive direction</p> <p>2 Proportional directional control valve VPWP</p> | <p>3 Filter regulator with 5 µm filter, without lubricator</p> <p>4 Working port 4 (black releasing ring):
→ Drive moves in the negative direction</p> |
|---|--|

Fig. 3.12 Pneumatic circuit diagram – example (without additional pneumatic circuitry)



Note

If the load or operating voltage for the CMAX is switched off or both are switched off, the VPWP proportional directional control valve will move to the mid-position. If the supply pressure remains switched on, due to the asymmetries in the piston pusher system of the proportional directional control valve, the drive can move slowly into an end position of the cylinder.

To place the system into a special status in certain applications, an additional pneumatic circuit is required, which can be implemented with the VABP sub-base, for example. Notes on this → www.festo.com/catalogue. In addition, the guideline for safety engineering from Festo contains various circuit recommendations (→ Appendix A.3).

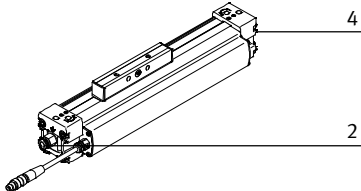
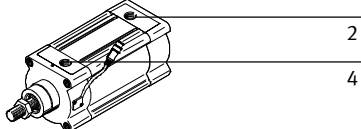
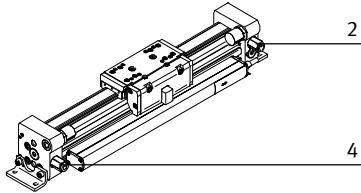
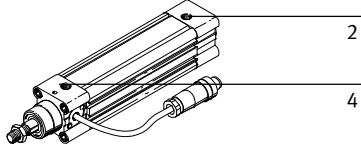
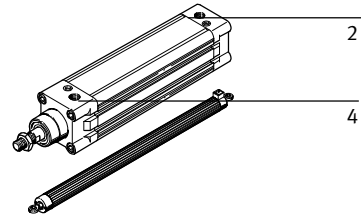
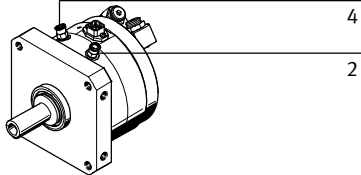
Drive	Direction of movement		Block circuit diagram for tubing connection with VPWP
	Negative (-)	Positive (+)	
DDLI	Towards the measuring system connection	Away from the measuring system connection	
DDPC	Retracted piston rod	Advanced piston rod	
DGCI	Towards the measuring system connection	Away from the measuring system connection	
DNCI	Retracted piston rod	Advanced piston rod	
DNC with MLO-POT-...-LWG			
DSMI	Anti-clockwise (looking at the drive shaft)	Clockwise (looking at the drive shaft)	

Tab. 3.8 Required direction of movement and tubing with VPWP

Tubing connection help for DGCI and DSMI-...-B



When ordering the DGCI with fittings – standard (not a modular system feature) or modular system features QD or QR as well as for DSMI-...-B: The fittings on the valve and drive have colour-coded release rings.

- Connect the ports with blue release rings and the ports with black release rings to each other with tubing.



Note

- Check tubing connection with the movement test.

Silencers

The VPWP is available with an integrated flat plate silencer.

When using the VPWP without an integrated flat plate silencer:

- Install silencers with a large nominal flow rate, e.g. UC-M5, U-1/8, U-1/4 or U-3/8 (dependent on the valve type).

When using the VPWP with ducted exhaust air:

- Guide the exhaust into a small air pressure reservoir. Exhaust the air pressure reservoir and with a large silencer. Make sure that the fittings and tubing provide sufficient flow (shortest possible tube length).

With correct design, this can markedly reduce the exhaust noise.

Notes on the conversion of systems

When systems are converted, the existing drives should normally continue to be used. Only drives with one-sided air connection are often available here and the cushioning path (PPV) is also used as the drive stroke.

In some cases, the expected positioning times cannot be fully achieved.



The specified positioning times and optimum system behaviour can only be achieved if the installation instructions described in the previous section are observed.

Drives with compressed air supply on one side

- Observe the following when using drives with air supply connection on one side:
 - Use a single-sided air supply connection only with drives with a stroke length ≤ 600 mm.
 - When air is supplied through port 4 of the proportional directional control valve, the drive must move in a negative direction, that is, toward the zero point of the displacement encoder. If compressed air is applied to port 2, the drive must move in a positive direction. In some cases, arrows on the drive indicate the direction of movement. After installation, the movement test must always be performed.
 - The resulting positioning times may vary according to the direction of the stroke.

3.6.5 Compressed air tubing and fittings

- Use only straight fittings. If elbow connectors cannot be avoided, use plug connectors from the Quick Star series.
- Select compressed air tubing and fittings of the required size as specified in section 3.4.1.
- Arrange the tubing between the valve (VPWP) and the drive as follows:
 - symmetrical
 - as short as possible

A tube length of 60 % of the cylinder stroke length is optimal.

Max. tubing length = cylinder stroke length

- Use only clean compressed air tubing and fittings.
- Do not use flow control valves or non-return valves in the air supply lines.
- Do not let the tubing project into the travel range.



To minimise the effects of bending forces on the positioning behaviour:

- Select a sufficiently large energy chain.

4 Electrical installation

4.1 Safety instructions



Warning

Danger of electric shock from voltage sources without protective measures.

- For the electrical power supply, use only PELV circuits in accordance with EN 60204-1 (Protective Extra-Low Voltage, PELV).
- Also observe the general requirements of EN 60204-1 for PELV circuits.
- Use only voltage sources which guarantee reliable electrical isolation of the operating and load voltage in accordance with EN 60204-1.
- Always connect all circuits for operating and load voltage supplies $U_{EL/SEN}$, U_{VAL} and U_{OUT} .

Through the use of PELV circuits, protection from electric shock (protection from direct and indirect contact) in accordance with EN 60204-1 is ensured (Electrical equipment of machines. General requirements).

ESD protection



Note

At unassigned plug connectors, there is the danger that damage may occur to the device or to other system parts as a result of ESD (electrostatic discharge).

- Seal unused connections with protective caps.



The CMAX power supply is provided via the CPX terminal (→ Section 4.5).

4.2 Earthing



CMAX earthing is provided via the CPX terminal (→ CPX system description).

- Observe the earthing measures described in the following – depending on the components used.



Note

Malfunctions can occur through incorrect or lack of earthing.

- Connect the specified connections to the earth potential with low resistance and low impedance.

Unless otherwise specified, the earthing conductors must have:

- cable cross section of at least 2.5 mm²
- a cable length as short as possible (typically 20 ... 30 cm)

Earthing VPWP proportional directional control valve

- Connect the earth terminal (→ Labelling on product) with low resistance and low impedance to the earth potential of the CPX terminal. To do this, use the supplied self-tapping screw.

Earthing sensor interface

- Connect the earth terminal with low resistance and low impedance to the earth potential of the CPX terminal.

Drive/displacement encoder earthing

- Connect the earth terminal with low resistance and low impedance to the earth potential.

Drive	Displacement encoder	Position of the earth terminal
DDLI	Integrated	Drive ¹⁾³⁾
DDPC		Drive ²⁾³⁾
DGCI	Permanently attached	Displacement encoder – Flat pin (nominal size [mm]: 4.8 - 0.8)
DNCI	Integrated	Drive ²⁾³⁾
DNC	External (MLO-POT-...-LWG)	Displacement encoder – flat pin (earthing strip included in the scope of delivery)
DSMI	Integrated	Drive

1) The female thread of the cover screws are suitable for cabling to the earth potential.

2) Use the supplied self-tapping screw. This ensures electrical contact is established in spite of the anodising layer.

3) Alternatively: Mount the drive on an earthed machine bed.

Tab. 4.1 Earthing notes

4.3 Axis connection

The peripherals of the positioning system are connected at the axis connection X of the CMAX. The VPWP proportional directional control valve is connected as the first component. The displacement encoder or a sensor interface (depending on the cylinder type or displacement encoder) is connected to the proportional directional control valve. These components together form the axis string. The following table shows the pin assignments of the axis connections of CMAX, VPWP and sensor interface CASM.

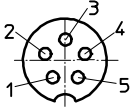
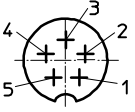
Pin	Assignment	CMAX: X VPWP: In	VPWP: Out CASM: S1
1	+ 24 V DC operating voltage		
2	+ 24 V DC load voltage		
3	0 V		
4	CAN_H		
5	CAN_L		
Housing	Cable screening ¹⁾		

1) Cable screening connected to the earth terminal at the VPWP

Tab. 4.2 Pin allocation of the axis connections

Axis string

The maximum permitted length (total) of the used connecting cables KVI-CP-3-... of the axis string is 30 m (total length CMAX – VPWP – sensor interface or displacement encoder).

Tab. 4.3 shows the recommended connecting cables.

Connecting cables ¹⁾	Length	Brief description
KVI-CP-3-WS-WD-0,25	0.25 m	Angled plug connector and angled socket
KVI-CP-3-WS-WD-0,5	0.5 m	
KVI-CP-3-WS-WD-2	2 m	
KVI-CP-3-WS-WD-5	5 m	
KVI-CP-3-WS-WD-8	8 m	
KVI-CP-3-GS-GD-2	2 m	Straight plug and straight socket
KVI-CP-3-GS-GD-5	5 m	
KVI-CP-3-GS-GD-8	8 m	

1) Cable between CMAX, VPWP, sensor interface, displacement encoder

Tab. 4.3 Connecting cables for the axis string

Cabinet through-hole

For the cabinet through-feed, we recommend the connecting component KVI-CP-3-SSD.

4.3.1 Proportional directional control valve VPWP

The VPWP has an incoming (In) and outgoing (Out) axis connection (➔ Tab. 4.2).

DO connection; digital output for brake/clamping unit

The digital output (DO) at pin 2 permits connection of a valve for a brake or clamping unit. Control is accomplished through the I/O data of the CMAX (➔ Communication profile description, P.BE-CPX-CMAX-CONTROL-...).



Note

For the CMAX to have the correct control function, the clamping unit or brake must always be switched with the following logic (➔ Fig. 4.2):

- Pin 2: 0 V = clamping unit/brake closed
- Pin 2: 24 V DC = clamping unit/brake open

Connection DO; load voltage output

The load supply voltage provided at pin 4 can also be used for switching a valve, for example when the load voltage supply + 24 V DC (U_{VAL}) fails (➔ Section 4.4.2).

Pin	Allocation	DO
1	n.c. (not assigned)	
2	Digital output (brake/clamping unit)	
3	0 V	
4	+ 24 V DC voltage output (load voltage)	

Tab. 4.4 Pin allocation of connection DO of the VPWP, M8 4-pin, socket

Technical data	Value
Digital output (pin 2)	
– Activation	Via I/O data
– Supply	From 24 V DC (U_{VAL})
– Max. current	500 mA
– Fuse protection	Protected against short circuits ¹⁾
– Design	Positive logic (PNP)
– Galvanic isolation	No
Voltage output (load voltage, pin 4)	
– Supply	From 24 V DC (U_{VAL})
– Max. current	500 mA
– Fuse protection	Protected against short circuits ¹⁾

1) Temperature switch-off: Maximum short-circuit current (short term) is defined only by the cable and connection resistance.

Tab. 4.5 Technical data of connection DO

4.3.2 Sensor interface CASM

The sensor interface CASM has an incoming axis connection S1 for connection of the VPWP (→ Section 4.3). The connection S2 serves to connect the displacement encoder (→ Tab. 4.6).

Drive	Displacement encoder	Sensor interface	Connecting cable to the displacement encoder
DGCI	Permanently attached	Not necessary	Permanently connected to the drive
DDLI	Integrated		
DNCI		CASM-S-D3-R7	
DDPC		CASM-S-D3-R7	
DNC	External, MLO-POT-...-TLF	CASM-S-D2-R3	NEBC-A1W3-K-0.3-N-M12G5
	External, MLO-POT-...-LWG		NEBC-P1W4-K-0,3-N-M12G5
DSMI	Integrated		

Tab. 4.6 Overview of sensor interfaces and measuring system cables

CASM-S-D3-R7

For digital, incremental measuring systems; M12 measuring system connection (socket, 8 pin)

Pin	Assignment	S2
1	+ Ub sensor (5 V)	
2	0 V	
3	Signal sine +	
4	Signal sine -	
5	Signal cosine -	
6	Signal cosine +	
7	Screening	
8	n.c. (not connected)	
Housing	Earth terminal (FE)	
The cable screening is connected to the earth terminal of the sensor interface.		

Tab. 4.7 Pin assignment of connection S2 at the CASM-S-D3-R7

CASM-S-D2-R3

For analogue, absolute measuring systems (potentiometer); M12 measuring system connection (socket, 5 pin)

Pin	Assignment	S2
1	Displacement encoder housing	
2	n.c. (not connected)	
3	Analogue GND (AGND)	
4	Analogue input 0 ... 5 V (INPUT)	
5	Earth terminal (FE)	
The cable screening is connected to the earth terminal of the sensor interface.		

Tab. 4.8 Pin assignment of connection S2 at the CASM-S-D2-R3

4.4 Power supply

Operating and load voltage are supplied to the CPX terminal through the interlinking blocks or other components of the CPX terminal (→ CPX system description). Components of the positioning system are supplied through the CPX-CMAX, which passes on the operating and load voltage of the CPX terminal.

The following is supplied	Power supply through
Internal electronics of the following components: – CMAX – VPWP – CASM (optional) – Displacement encoder	Operating voltage supply for electronics/sensors ($U_{EL/SEN}$) of the CPX terminal ¹⁾
Valve drive VPWP	Load voltage supply of valves (U_{VAL}) of the CPX terminal ¹⁾
+ 24 V DC voltage output VPWP	
Digital output VPWP (output brake)	

1) Additional information → CPX system description.

Tab. 4.9 Operating and load voltage supply of the positioning system



Note

Malfunctioning due to power supply outside the tolerance.

The module with the lowest tolerance always determines the permitted voltage tolerances.

- When the CMAX is used, special tolerances in accordance with Tab. 4.10 must be observed for the load voltage to the valves (U_{VAL}) of the CMAX interface.

Load voltage supply to valves (U_{VAL})	Tolerance range ¹⁾	
Load voltage supply for CMAX	[V DC]	20 ... 30

1) Additional information on permissible tolerance ranges of the CPX terminal → CPX system description.

Tab. 4.10 Permissible tolerance range of the load voltage supply of the CMAX

4.4.1 Determining the current consumption

The current consumption of a CMAX depends on the number and type of modules at the axis connection. Recommendation:

- Use a regulated power supply.
- When selecting the power supply unit, check whether it has sufficient output. To do this, calculate the total current consumption.

Calculation

Tab. 4.11 and Tab. 4.12 show the current consumption for a positioning system.



Observe the notes on selecting the power supply unit in the CPX system description.

Current consumption of the CMAX from $U_{EL/SEN}$ of the CPX terminal		
Current consumption at nominal operating voltage	[mA]	200
Maximum current consumption		400

Tab. 4.11 Current consumption from $U_{EL/SEN}$ of the CPX terminal

Current consumption of the CMAX from U_{VAL} of the CPX terminal		
Max. current consumption of valve drive VPWP	[A]	1.2
Max. load current of the digital output VPWP – optionally usable		0.5
Max. load current of the voltage output VPWP – optionally usable		0.5
Total current consumption (max. 2.5 A)		2.2

Tab. 4.12 Current consumption of the CPX terminal from U_{VAL}

4.4.2 Power supply concept, formation of power zones

The modular power supply arrangement of the CPX terminal facilitates formation of voltage zones. The internal electronics of the VPWP, the digital displacement encoder and the sensor interface are supplied with power from the electronics/sensors operating voltage supply ($U_{EL/SEN}$). The VPWP load voltage and the digital outputs at the VPWP are supplied with power from the valve load voltage (U_{VAL}) (→ Section 4.4).



Note

The CMAX connects internally the contact rails $U_{EL/SEN}$ (0 V) and U_{VAL} (0 V) of the CPX terminal.

- As a result, the operating voltage supply for the electronics/sensors ($U_{EL/SEN}$) of the CPX terminal and the load supply for the valves (U_{VAL}) supplying the CMAX are no longer electrically isolated, regardless of the system supply used, up to the next additional power supply for valves.
- As a result, complete electrical insulation (all pins) of the load voltage of the VPWP is **not** possible, even in connection with an additional power supply for valves CPX-EV-V.



Note

Damage to components and malfunctions!

The load voltage supply (U_{VAL}) for the CMAX and the components of the positioning system must be supplied with the same potential as the operating voltage supply for electronics/sensors ($U_{EL/SEN}$).

- Use a shared power supply unit (→ Fig. 4.1).



Observe the information on power supply and the required earthing measures in the CPX system description (P.BE-CPX-SYS-...).

Example of CPX terminal with CMAX with a system feed without additional power supply

In the example, the entire CPX terminal and the CMAX positioning system are provided with power through a system supply. The VPWP load voltage can only be switched off single-pole!

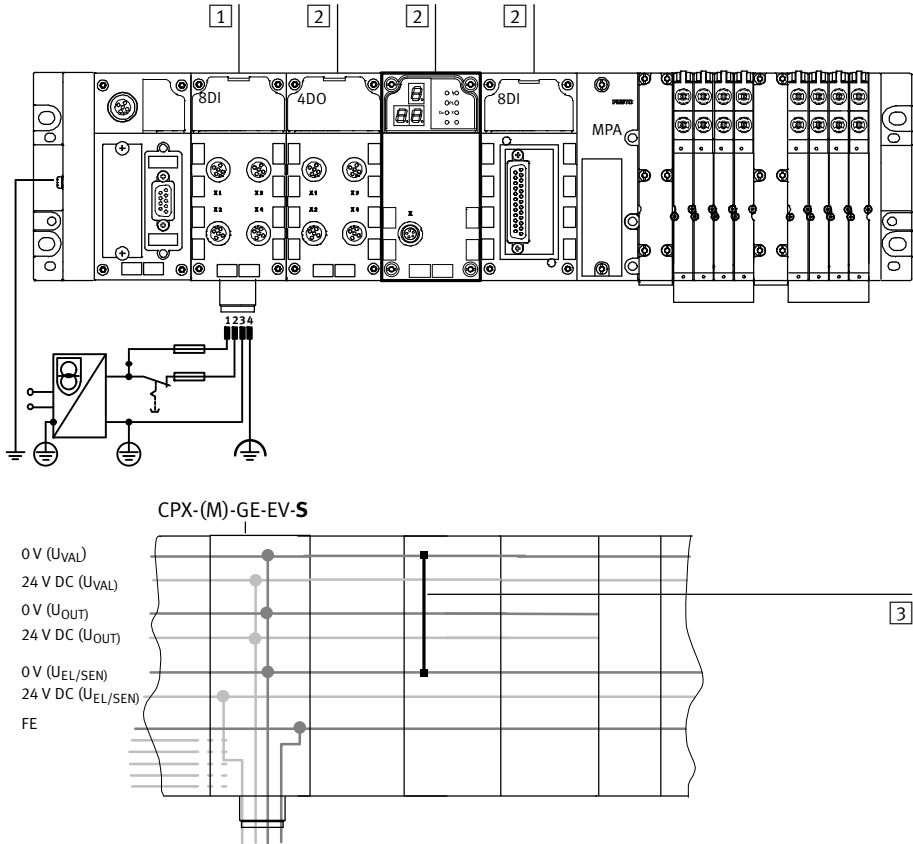

- 1 Interlinking block with system feed ...-EV-S (supplies the CPX terminal with CMAX and positioning system, here 4-pin)
- 2 Interlinking blocks without supply
- 3 The CMAX always internally connects at the module level the contact rails $U_{EL/SEN}$ (0 V) and U_{VAL} (0 V)

Fig. 4.1 Common power supply of CMAX and MPA pneumatics (example)

In the 4-pin system supply shown here, all 0 V potentials are also internally connected (→ Fig. 4.1). Potential separation between $U_{EL/SEN}$ (0 V) and U_{VAL} (0 V) can be achieved again through an additional power supply for valves to the right of the CMAX (→ Fig. 4.2).

Shut-down of the load voltage in connection with a brake or clamping unit

In the following example, circuitry for a brake or clamping unit is connected to the digital output of the VPWP. During switch-off (➔ Fig. 4.2, 1) or failure of the load voltage for the valves (U_{VAL}) of the CMAX, the brake or clamping unit is activated. The brake or clamping unit can also be controlled by the higher-level PLC using a program via the digital output of the VPWP (➔ Fig. 4.2, 3).

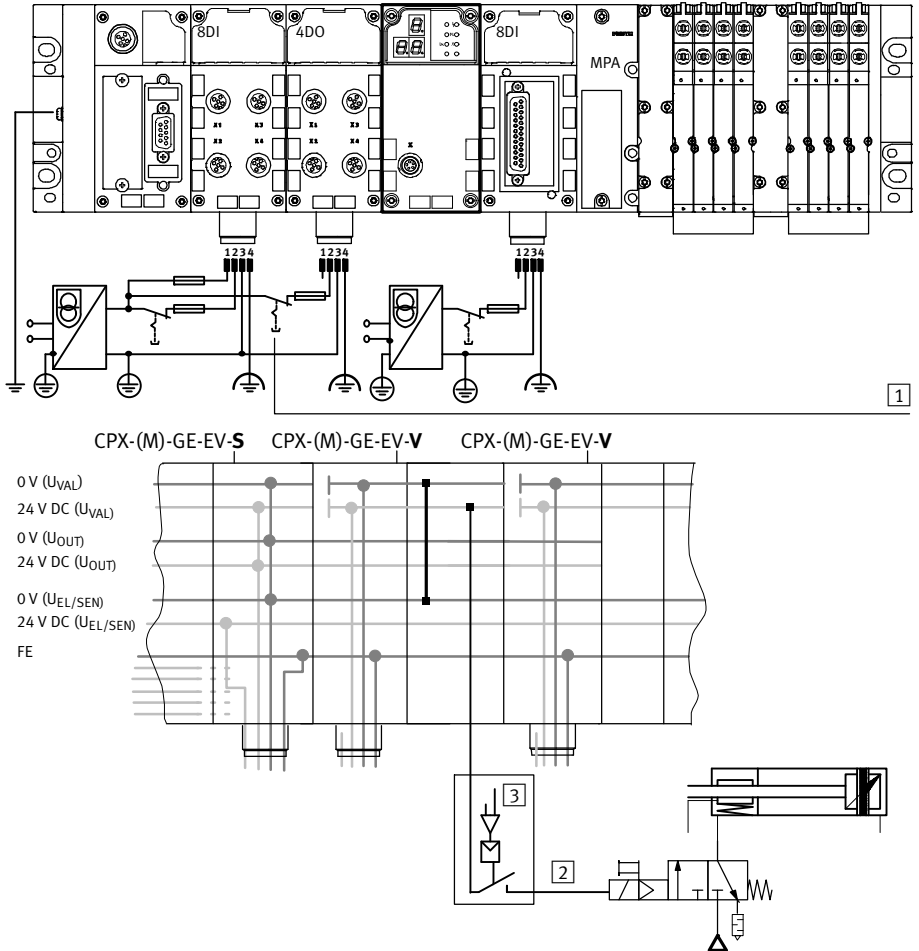

- 1 Switching off the load voltage possible
- 2 Output VPWP
- 3 Activation/Deactivation of the brake/clamping unit by the higher-level PLC

Fig. 4.2 Switching off of the load voltage supply of the output at the VPWP together with the valve load supply (example)

5 Commissioning

5.1 Important notes on commissioning

This description provides an overview for commissioning the positioning system with the CMAX using the Festo Configuration Tool with the CMAX plug-in.



Information about configuration of the CMAX with specific CPX nodes as well as the description of commissioning via the CPX node → Communication profile description, P.BE-CPX-CMAX-CONTROL-...



Recommendation: Perform configuration and commissioning of the CMAX with the newest FCT plug-in CMAX. Only the latest FCT plug-in offers comprehensive support and use of all functions of the CMAX.



Note

Errors in the system structure and incorrectly set parameters can cause the drive to move uncushioned to an end position. This can destroy the drive.

- Before applying compressed air, set the configuration and application data correctly.
- In the following cases, always perform the movement test after the compressed air is switched on so that a defective tubing connection can be detected:
 - at the first commissioning (after installation)
 - after replacement of the drive, the displacement encoder or the proportional directional control valve VPWP
 - after changes to the tubing connection
- During operation, make sure that the permitted total load is observed.



Recommendation:

- Attach corresponding warning signs to your system.



Recommendation: when commissioning with the Festo Configuration Tool:

To avoid influence by I/O signals:

- Perform commissioning without bus (pull off bus line) or reset, defined to 0, the PLC output data for the CMAX.

With use of a control block (CPX-FEC, CPX-CEC):

- Switch the control block to stop!

5.2 Parameterisation and commissioning options

Operation via	Features
FCT plug-in CMAX ¹⁾	<ul style="list-style-type: none"> – Convenient commissioning through special dialogues and functions – Direct operation with drive monitoring possible – The PC must be connected with the diagnostic interface or the Ethernet interface of the CPX terminal bus node.
Higher-order controller or control block (CPX-CEC, CPX-FEC) ²⁾	<ul style="list-style-type: none"> – Commissioning and teaching require additional programming effort in the PLC program – No FCT required

1) Detailed information on this → Help for the CMAX plug-in

2) Information on this → Communication profile description, P.BE-CPX-CMAX-CONTROL-...

Tab. 5.1 Commissioning, parameterisation and teach options



Parameterisation and commissioning via FMT or CPX-MMI is **not** supported. Always perform parameterisation and commissioning of the CMAX with the FCT plug-in CMAX or the higher-order controller.

5.2.1 Communication profile FHPP

Customised for handling and positioning tasks, Festo has developed an optimised communication profile, the “Festo Handling and Positioning Profile (FHPP)”. The FHPP enables uniform control and programming for the various bus systems and controllers from Festo. The following is uniformly defined for the user through FHPP:

- Operating modes
- I/O data structure
- Parameters
- Sequence control



Detailed information on the FHPP → Communication profile description, P.BE-CPX-CMAX-CONTROL-....

5.2.2 Festo Configuration Tool (FCT)

The Festo Configuration Tool (FCT) is the software platform for configuring and commissioning various components and devices from Festo. The FCT consists of the following components:

- a framework as program start and entry point with uniform project and data management for all supported types of equipment
- a plug-in for the special requirements of each device type (e.g. CMAX) with the necessary descriptions and dialogues. The plug-ins are managed and started from the framework.

The CMAX plug-in supports performance of all the steps necessary for commissioning a CMAX. All necessary configuration and parameterisation data are stored in a project for this purpose. With the plug-in, most of these data can be generated offline, i.e. without the CMAX being connected to the PC, such as for preparation of the actual commissioning during design of a system.



The Help function for the FCT includes all information for the operation of the Festo Configuration Tool. The device-specific plug-ins each have their own Help files.

Installing the FCT

The FCT runs on the Windows operating system. The FCT, together with the CMAX plug-in, is installed on your PC with an installation program.



Administrator rights are required for installing the FCT. Current installation files for the FCT with plug-in for the CMAX → www.festo.com/sp – search term CMAX.

1. Load installation program from the Internet page.
2. Close all programs.
3. Start installation program.
4. Follow instructions on the screen.

Starting the FCT

1. Start FCT as follows:
 - Double-click on the FCT icon on the desktop.
 - Or in the start menu, select the entry [Festo Software][Festo Configuration Tool].



Information on connection of the CPX terminal to the CMAX and a PC → Section 5.3.3.

FCT Help

Call up with the [Help][Contents FCT general] menu command. Help contains the following information, for example:

- working with projects
- selection of components (e.g. for adding a component (device) to a project)

Plug-in Help

Call up with the menu command [Help][Contents of installed plug-ins][Festo (manufacturer name)][CMAX]. Help contains the following information, for example:

- Dialogues of the component CMAX
- Work steps for commissioning
- basic functions (e.g. linkage of equipment, device names, device control)

Printed information

To use the complete Help or parts thereof independently of a PC:

- Print individual pages of the Help or all pages of a book directly from the Help table contents using the “Print” button in the Help window.
- Print out a prepared print version of the Help in Adobe PDF format.

Help	Folder	File
FCT Help	(FCT installation folder)\Help\	FCT_de.pdf
Plug-in Help (CMAX)	(FCT installation folder)\HardwareFamilies\Festo\CMAX\ V...\Help ¹⁾	CMAX_de.pdf

1) V... = Version of the plug-in e.g. V0108 for V1.8 or V0202 for V2.2

Tab. 5.2 Printed information



In order to use the printed version in Adobe PDF format, Festo recommends Adobe Reader.

5.3 Preparations for commissioning

5.3.1 Checking the axis string

Prior to commissioning:

- Check the complete system structure, especially the tubing connection of the drive and the electrical installation (→ chap. 3 and chap. 4).



Preliminary parameterisation of the CMAX is possible even without connected components at the axis connection (without valve, displacement encoder or sensor interface).

5.3.2 Switching on the supply voltage, switch-on behaviour



Warning

High acceleration forces of the connected actuators!

Uncontrolled movements can cause collisions, which can lead to serious injury.

- **Switching on:**
Always first switch on the load voltage supply for valves and then the compressed air supply.
- **Switching off:**
Before carrying out mounting, installation and maintenance work, place the system in a safe status (e.g. by placing the drive in a safe position and locking it).

Delivery status (switching on for the first time or after data reset)

- The connected components (valve and displacement encoder or sensor interface) are automatically searched for at the axis interface, and the information included is read.
- The recognised components (actual configuration) are not automatically accepted as the setpoint configuration.
The setpoint configuration (characteristics of the connected components, such as size, stroke, etc.) must be compared at commissioning with the actual configuration (→ Fig. 5.1).
- Without complete parameterisation of the axis data, the positioning system cannot be activated.
Actual values are not updated.

Standard run up

- The connected components (valve and displacement encoder or sensor interface) are automatically searched for at the axis interface, and the information included is read.
- The actual configuration found is compared to the setpoint configuration. A deviation results in an error. This error can only be acknowledged after a comparison of the setpoint and actual configuration (→ Fig. 5.1).

Recognisable parameters

The CMAX automatically reads out all configuration and parameter values stored in the drive, displacement encoder and valve. The FCT plug-in can read these data out of the CMAX during commissioning. The data do not have to be entered in the FCT project. The data cannot be overwritten by the FCT plug-in.

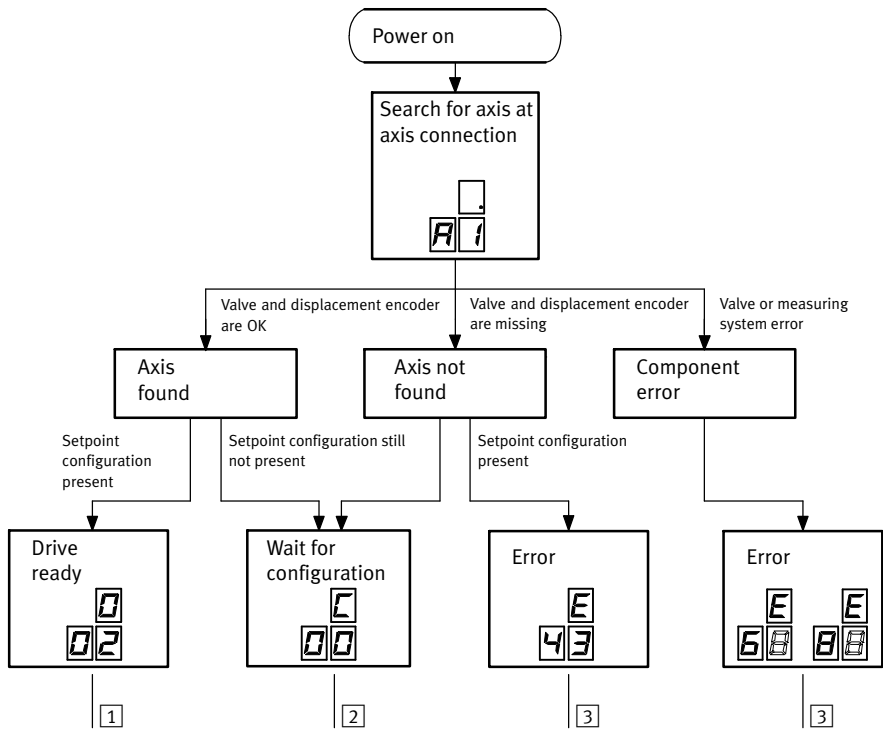

1 Initial start-up executed; CMAX ready for operation

2 Status when switching on for the first time (in delivery status or after data reset): Wait for initial start-up, display → Tab. 5.3

3 Error (→ Chapter 6)

Fig. 5.1 Switch-on behaviour

Display	Description
C00	Wait for configuration of the dimension system.
C01	Wait for configuration of the drive type.
C02	Wait for configuration of the axis data.
C03	Wait for execution of the movement test.

Tab. 5.3 Display during commissioning



An overview of the status indicators on the display is shown in segment 6.3.2.

5.3.3 Make connection to the PC

A serial connection to the PC is created via the Service interface of the bus node. A network connection to the PC can be created for bus nodes with a network interface.



Information on the network connection → Documentation on the bus node used.



The following is required to create a serial connection between the PC and CMAX over the Service interface of the CPX node:

- adapter NEFC-M12G5-0.3-U1G5 (→ www.festo.com/catalogue)
- commercially available USB cable with mini USB plug connector

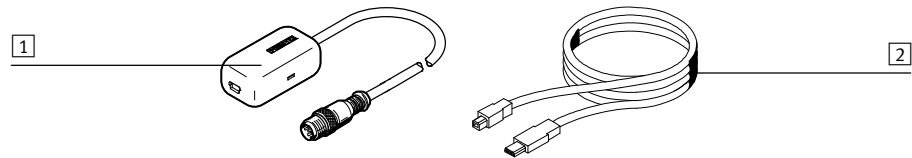

1 Adapter NEFC-M12G5-0.3-U1G5

2 Commercially available USB cable

Fig. 5.2 Adapter for serial connection to the PC



Observe the notes and restrictions for operation named in the documentation of the adapter.

Current drives for the adapter NEFC-M12G5-0.3-U1G5 → www.festo.com/sp.

Seal the service interface of the CPX node after commissioning with the protective cap supplied.

5.4 Commissioning with the FCT (overview)



Detailed information on commissioning with the FCT → Help for the FCT plug-in CMAX. Information on commissioning via the CPX node → Communication profile description, P.BE-CPX-CMAX-CONTROL-....

5.4.1 Overview of commissioning steps

Preparations for commissioning

1. Check the construction of the positioning system with the components used on the axis string (→ Section 5.3.1).
2. Check power supply of the CPX terminal.
3. Install FCT and CMAX plug-in on the PC.
4. Create or open a project in the FCT. Add a new “component” with the CMAX plug-in.

The following steps are typically performed during commissioning:

Caution: Leave the compressed air supply switched off at first.

1. Switch on power supply (→ Section 5.3.2).
2. Configure FCT interface (dependent on the connection → Section 5.3.3).
3. Create device connection (online connection) between PC and CMAX via FCT.
When the CMAX is in the delivery status (display C00), the configuration wizard is automatically started when the equipment linkage is created.
4. Parameterise application data and load into the CMAX by download:
 - Load
 - Supply pressure
 - Mounting position
 These application data are the foundation for setting the controller.
5. Set additional parameters and download them into the CMAX (e.g. software end positions, record table).
6. Switch on the compressed air supply.
7. Carry out the movement test.
8. Only for incremental displacement encoder: Perform homing.
9. Carry out identification travel.
10. Carry out test run.

After commissioning of the positioning system (→ Communication profile description, P.BE-CPX-CMAX-CONTROL-...) perform the following steps:

1. Configure the CPX bus node or control block (CPX-FEC, CPX-CEC).
2. Check controller of the positioning system with the CMAX.

Preliminary configuration and parameterisation (e.g. in office)

The CMAX can be preliminarily configured and parameterised even without connected components. All necessary data must be entered for that purpose. After the valve and the displacement encoder or sensor interface have been connected, the CMAX performs automatic hardware recognition after it is switched on. The data recognised thereby are then accepted as setpoint configuration by the FCT if the component data agree with those in the FCT project.

5.5 Notes on operation

5.5.1 Control of the CMAX



Description of the I/O data on control of the CMAX and flow charts for programming
 → Communication profile description, P.BE-CPX-CMAX-SYS-....

5.5.2 General instructions on operation



Warning

High acceleration forces of the connected actuators!
 Uncontrolled movements can cause collisions, which can lead to serious injury.

- **Switching on:**
 Always first switch on the load voltage supply for valves and then the compressed air supply.
- **Switching off:**
 Before carrying out mounting, installation and maintenance work, place the system in a safe status (e.g. by placing the drive in a safe position and locking it).



Note

Damage may occur if maximum permitted limits, such as loads, mass moments of inertia and swivel frequencies, are exceeded.

- Make sure that the specified limits of the drive used are observed (→ Operating instructions for the drive).

Positioning commands

After switching on the operating voltage, you must wait until the CMAX is completely initialised, no error is reported (→ Fig. 5.1) and the inputs SCON.ENABLED and SCON.READY supply logic 1. After that, the corresponding positioning command can be executed via the control bytes (module output data) of the corresponding positioning command (→ Communication profile description, P.BE-CPX-CMAX-SYS-...).

Homing run after POWER ON

Only for incremental displacement encoder: After renewed switch-on of the CMAX operating voltage, the relationship between measured value and current position is lost. For that reason, you must always carry out homing after a renewed switch-on.



After the power supply is switched on again, with incremental measuring systems, only the positioning commands homing (CPOS.HOM), jogging (CPOS.JOGx) and the movement test are permitted. Other positioning commands result in error E10 (drive is not referenced → Communication profile description, P.BE-CPX-CMAX-SYS-...).

6 Diagnostics and error handling

6.1 Summary of diagnostics options

Access/ function	Diagnostics option	Brief description	Detailed description
Local Display on the device	LED display	The LEDs display operating statuses and errors directly. Fast “on-the-spot” diagnostics	Section 6.2
	Display/ 7-segments display	The operating status and error messages are shown on the display. Fast diagnostics with “on-site” status and error detection	Section 6.3
	CPX-MMI	CPX module diagnostics ¹⁾ can be displayed on the CPX handheld terminal → Section 6.4.3.	Operator unit description
Local With PC (e.g. during startup)	FCT with CMAX plug-in	Plain-text display of all diagnostic information during commissioning and service. Full access to the diagnostic functions of the CMAX.	Help for the CMAX FCT plug-in
	CPX-FMT	The CPX-FMT can be used to display the CPX module diagnostics ¹⁾ → Section 6.4.3.	Help for the CPX-FMT
PLC Via I/O data	Module input and output data	In the input data, diagnostic information is permanently transferred (e.g. the bits SCON.WARN and SCON.FAULT or actual values, such as the current position)	Communication profile description CMAX
	CPX status bits, I/O diagnostic interface	The CPX module diagnostics ¹⁾ are reported to the CPX node → Section 6.4.3. Optimal integration into the CPX module concept.	Communication profile description CMAX
PLC Through communication profile	FHPP diagnostics	Diagnostic parameters, diagnostic memory, error texts	Communication profile description CMAX

1) Only the groups of the CMAX error messages are displayed in the CPX diagnostics.

Tab. 6.1 Diagnostics options

6.2 Diagnostics via LEDs

LEDs for diagnosing the CPX terminal are provided on the CMAX as well as on the individual modules at the axis connection.

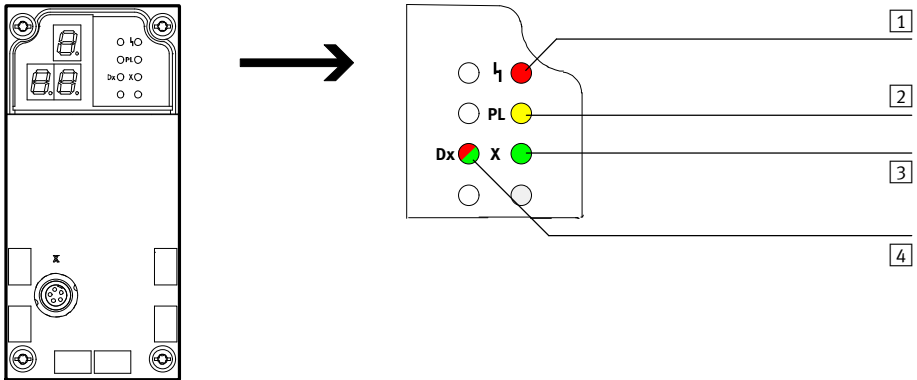







- 1 Error: ⚡ (red)
- 2 Power load: PL (yellow)
- 3 MC axis X: X (green)
- 4 Status axis X: Dx (green/red)

Fig. 6.1 LEDs at CPX-CMAX-C1-1

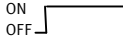

LED		Description
⚡	Error LED	Illuminated red: error
PL	Power load	Illuminated yellow: load voltage supply (U_{VAL}) correct.
Dx	Display axis X	Illuminated green: Shows operating status of the axis X in the display. Illuminated red: Shows error in the display.
X	MC axis X	Illuminated green: Positioning job completed (MC = 1). Off: Positioning command active (MC = 0), axis is missing/being installed.

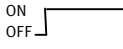

Tab. 6.2 LED display in operation after initialisation

6.2.1 CMAX-specific LEDs

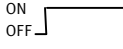

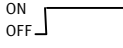

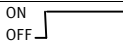
h₁ (Error) – CMAX error		
LED (red)	Sequence	Status
 LED is off		No error
 LED illuminated		Error of the CMAX. Shows the error number in the display (After the power supply is switched on, the LED illuminates briefly)
PL (Power load)		
LED (yellow)	Sequence	Status
 LED illuminated		24 V valve load voltage supply is present.
 LED is off		Undervoltage at the valve load supply (U_{VAL}) or load supply is not present.

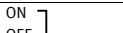



6.2.2 Axis-specific LEDs

Dx (display axis X) – displays status of axis X		
LED (green/red)	Sequence	Status
 Illuminated green		No error: Shows operating status of axis X in the display
 Illuminated red		Axis X reports an error. Shows the error number in the display



X (MC Axis X) – Display of axis X motion complete		
LED (green)	Sequence	Status
 Illuminated green		Axis X: MC = 1: Last positioning command completed.
 LED is off		Axis X: MC = 0: positioning command active. or axis X is being initialised.

6.2.3 LEDs at the proportional directional control valve VPWP

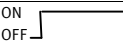
Power – VPWP logic supply		
LED (green)	Sequence	Status
 Illuminated green	ON OFF 	24 V logic supply is present.
 LED is off	ON OFF 	VPWP logic supply is not present. Error CMAX (example): E60

Error– error VPWP		
LED (red)	Sequence	Status
 LED is off	ON OFF 	No error
 LED flashing	ON OFF 	Warning – Temperature shortly before shut-down – Logic supply lies below 17 V Error/warning CMAX (example): W68 or E65
 LED illuminated	ON OFF 	Error ¹⁾ Error with the CMAX (example): E61, E62, E63, E66 or E67

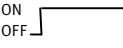
1) Message about a CMAX error → Section 6.4.4, Group 6.

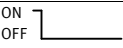
PL – VPWP load supply		
LED (yellow)	Sequence	Status
 LED illuminated	ON OFF 	24 V VPWP load voltage supply is present.
 LED is off	ON OFF 	VPWP load voltage supply is not present or error. Error with the CMAX (example): E51, E64

6.2.4 LEDs at the sensor interface CASM

LEDs at the CASM-S-D2-R3			
LED S1	LED S2	Status	Error CMAX
Green	Off	Ready to operate without error	–
Off	Off	24 V not present.	E80
Green	Flashes red 1x	Error: displacement encoder error (supply voltage < 12 V longer than 15 ms)	E82
Green	Flashes red 2x	Error: displacement encoder error (cable break in the measuring system cable or electrical end position reached)	E87
Green	Flashes red 3x	Error: supply voltage (< 17 V longer than 15 ms)	E85
Green	Flashes red 4x	Error: communication error (bus off status).	E80
Green	Red	Initialising via CAN completed.	–
Flashes green	Red	24 V present.	–

LEDs at the CASM-S-D3-R7			
LED S1	LED S2	Status	Error CMAX
Green	Off	Ready to operate without fault	–
Green	Red	Initialising via CAN completed.	–
Flashes green	Red	24 V present.	–
Flashes green	Off	Not yet referenced.	– (E10)
Off	Off	24 V not present.	E80
Green	Flashes red 1x	Error: displacement encoder error	E82
Green	Flashes red 2x	Error: displacement encoder cable (broken cable)	E87
Green	Flashes red 3x	Error: supply voltage (< 17 V longer than 15 ms)	E85
Green	Flashes red 4x	Error: communication error (bus off status).	E80

6.2.5 LEDs at the displacement encoder DGCI

LEDs at the displacement encoder DGCI			
Power LED	Error LED	Status	Error CMAX
Green	Off	No error (normal operating status)	–
Off	Off	No power supply	E80
Off	Red	Error: Initialising via CAN failed.	E80
Green	Red	Error: Magnet not recognised or incorrect number of magnets.	E82
Flashes green	Flashes red	Error: Operating voltage not within permissible range.	E85

6.3 Diagnostics via display

The CMAX shows status and diagnostic information directly on the display (7-segments display).

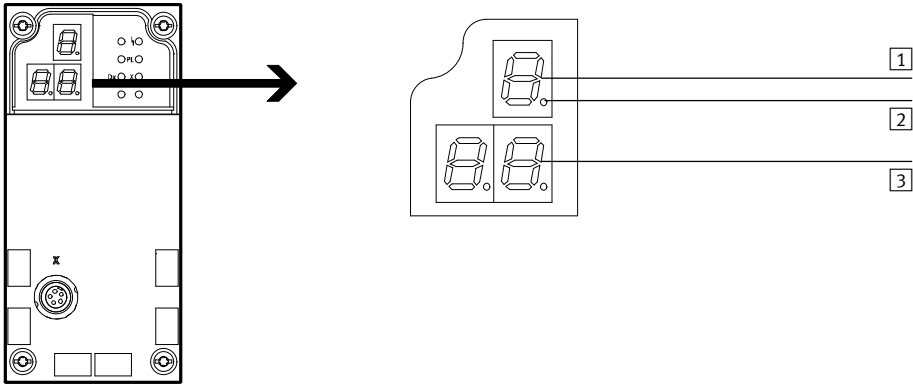

- 1 Position 1.: status display
- 2 Point for separation
- 3 Position 2. and 3: additional information

Fig. 6.2 Structure of the display

6.3.1 Error display

In case of an error, E for Error is shown as status display. Additional information is the number of the error message. The CMAX always shows in the display the first error that occurred. If additional errors occur, they are not displayed even if they are more serious.

Example

Display		Description
	E	E = Fault (Error) is present
	50	Number of the error message of the first error (here 50)









Tab. 6.3 Error display – example E50: Operating pressure is too low; → Section 6.4.4











Possible error and warning numbers → Section 6.4.4. Possible status displays and additional information on the display → Section 6.3.2.

Warnings are not shown in the display.

6.3.2 Status display









Possible status information			
Status display	Additional information	Description	Example
“.” flashes	On	Initialization of the components at the axis connection n (here 1). Point flashes during the entire initialization phase.	
n	nn	After initialization of the components at the axis connection, the firmware design is displayed for approx. 1 s (e.g. V 2.00).	
C	nn	Parameterisation phase; additional information shows the current status: 00: Wait for measurement system 01: Wait for drive type 02: Wait for axis data 03: Wait for movement test	
0	nn	Initialization successfully completed; there is no release present; additional information shows the current operating mode: 02: Record mode 03: Direct mode 04: Commissioning 0P: Parameterisation	
1	nn	Ready for operation, additional information shows the current operating mode: 02: Record mode 03: Direct mode 04: Commissioning 0P: Parameterisation	
2	nn	Record mode; additional information shows the last or current positioning record nn (here 01). Decimal point in the status display flashes when a positioning command is active (MC = 0).	
3	nn	Direct mode; additional information shows position nn in percent of the cylinder length (here 47 %). Decimal point in the status display flashes when a positioning command is active (MC = 0).	
4	00	Commissioning; additional information 00 = ready.	

Possible status information			
Status display	Additional information	Description	Example
5	nn	Homing active, position nn in percent of the cylinder length (here 47 %). Decimal point flashes when a positioning command is active (MC = 0).	
6	nn	Jogging active, position nn in percent of the cylinder length (here 47 %). Decimal point in the status display flashes when a positioning command is active (MC = 0).	
7	nn	Identification active, current progress nn in % (here 94 %). Decimal points of the two additional information digits flash alternately if identification is active (MC=0).	
8	nn	Movement test active, current progress nn in % (here 5 %). Decimal points of the two additional information digits flash alternately if identification is active (MC=0).	
t	nn	Teaching via I/O data active. The display is shown for the duration of 1 second with a trailing edge at CPOS.TEACH. After that, the display switches back into the current or original status. The additional information depends on the operating mode. Record mode: nn (here 04 for record number 4): teaching the displayed record number Commissioning: -3: Teach target: project zero point -4: Teach target: lower software end position -5: Teach target: upper software end position	
P	nn	Parameterisation active; additional information shows current parameter nn in the form PNU/100 (PNU 400 becomes 04). If a parameter is changed acyclicly or in the parameterisation operating mode, the corresponding PNU is displayed as PNU/100 for the duration of 1 second. No display appears during read parameter access or a parameter access over the diagnostic interface (FCT CMAX plug-in). If a new write parameter access is made within this display time window, the new PNU is displayed as PNU/100 and the display time begins again (1 second). If in the parameterisation operating mode, no parameter has been changed yet or the display time has expired, the additional information will depict "--".	

Possible status information			
Status display	Additional information	Description	Example
E	nn	Error active (E); additional information shows error number nn (here 72); description of the error numbers → Section 6.4.4. 0x: configuration error 1x: execution error 2x: positioning record error 3x: control error 4x: system error A 5x: system error B 6x: error in the valve 7x: error in the controller 8x: error in the displacement encoder	
“_” flashes	“_ _” flashes	Device data reset. To complete resetting, the CMAX must be switched off and back on again.	

Tab. 6.4 Status information display

Possible messages during a firmware update of the CMAX through the FCT plug-in

Possible status information			
Status display	Additional information	Description	Example
8	88	System initialisation	
Off	Off	Waiting for the end of initialisation of the CPX bus node	
“.” flashes	nn	Download firmware file, current progress nn in %	
“.” flashes	Ud	Decompression of the firmware file (Uncompress Data)	
E	Ud	Error during decompression of the firmware file (Error Uncompress Data)	
“.” flashes	Pd	Programming of the firmware file in the flash memory (program data)	
E	Pd	Error in programming the firmware file in the Flash memory (Error Program Data)	
F	FU	Firmware update successfully completed (Finished Firmware Update)	

6.4 Faults and warnings

The CMAX permanently monitors the operating status and issues corresponding diagnostic messages in the event of deviations from the nominal status.

Diagnostic messages for malfunctions are categorised as faults or warnings, depending on the cause and effect, and can be evaluated in detail and processed.

Malfunctions	Effect	Acknowledge
Faults Events and statuses that jeopardize or prevent correct operation of the CMAX.	<ul style="list-style-type: none"> – Red fault LED is illuminated – Fault number E... is shown on the display – SCON.FAULT = 1 is set – Effect on the sequence control dependent on the malfunction step → Section 6.4.1 	Required → Section 6.4.2
Warnings Events and statuses that may impair operation.	<ul style="list-style-type: none"> – SCON.WARN = 1 is set – The sequence control and the axis are not affected 	Not required

Tab. 6.5 Faults and warnings



List of faults and warnings → Section 6.4.4.

Some diagnostic messages can be classified optionally as warning or fault with FCT or PNU 228:03. Section 6.4.4 shows the step assigned at the plant (e.g. F2). Alternative steps that can be set are listed in brackets. F2 (W) therefore means “factory setting step F2, alternative step W”.

6.4.1 Effect on the sequence control and axis – malfunction step

Dependent on the malfunction step, faults and warnings have the following effect:

Malfunction step	Effects on		SCON ¹⁾	
	Sequence control	Axis	FAULT	WARN
W (Warning)	– (None)		–	1
F1 (Fault 1)	Transition to the “fault” status	Stop	1	–
F2 (Fault 2)		Drive blocked	1	–
FS (System fault)	System fully stopped		x	x

1) Status of status bits: – = no effect; 0 = logic 0, 1 = logic 1; x = no updating

Tab. 6.6 Malfunction steps

- F1 (fault 1): The axis is stopped. Behaviour with stop → Communication profile description.
- F2 (fault 2): Controller inactive, the drive moves using residual energy until it comes to rest. If communication with the displacement encoder/sensor interface fails, the possibility exists that homing may be lost (SPOS.REF = 0).
- FS (system fault): It may no longer be possible to update the I/O data. Switching off/on required.

6.4.2 Acknowledgement of faults and warnings – reset type

Acknowledge fault

Faults must be acknowledged with CCON.RESET before a new positioning command can be started. In most cases, the cause of the fault must be eliminated.

1. Rising edge at CCON.RESET.
2. Wait 3 s (depending on the fault, the CMAX requires a maximum of 3 seconds, e.g. to initialize the axis).
3. Check whether the fault has been eliminated:
 - If SCON.FAULT = 0: ok
 - If SCON.FAULT = 1: check error number, eliminate cause → Section 6.4.4.

In principle, the CMAX always tries to acknowledge all currently pending faults. If several faults are active at the same time, the behaviour is oriented on the most serious fault → Section 6.4.1.

If there are several faults pending and one fault can be deleted after a reset, but not others, one of the remaining faults is displayed after the reset.

The reactions of the CMAX to acknowledgement of various faults are divided into reset types

→ Tab. 6.7.

Reset type	Significance	Action when acknowledging
R	Reset	The “fault” status is exited
F	Reset if fixed	The “fault” status is exited if the cause has already been eliminated (example: E51 active and load voltage has not been applied again).
N	New initialisation and reset	The CMAX newly initialises the components valve and sensor interface as well as the controller. If no fault occurs, the “fault” status is exited. The maximum time for a restart is 3 s. After the restart, homing must be performed again.
Poff	Reset with power off	The CMAX does not react to acknowledgement (CCON.RESET). The CPX terminal with the CMAX must be switched off and back on again or a “Restart CPX terminal” must be performed in the FCT (from V2.2).

Tab. 6.7 Reset types

Acknowledging warnings

Warnings do not have to be acknowledged. With rising edge at CPOS.START (new positioning command) or CCON.RESET (provided the cause has been eliminated), SCON.WARN = 0 is set.

6.4.3 Illustration of CMAX error numbers in the CPX terminal

The CMAX faults and warnings are arranged in groups. The first digit of the fault and warning number specifies the group. The second digit points out the specific message. The CMAX reports to the CPX node only the group of the message. The groups of the CMAX are assigned to the group of numbers 100 to 108 of the CPX terminal (→ CPX system description, error numbers). The last digit of the diagnostic message specifies the group.



Specification of the group in the diagnostic message of the CPX terminal is not sufficient for detailed evaluation. Evaluate error and warning numbers via the I/O data (PNU 220, 224, ...), FCT plug-in or the display.

Allocation of CPX error numbers and groups of the CMAX			
CPX fault	CPX fault text (MMI, configuration software)	Group → Section 6.4.4	
100	[Configuration error]	0	Configuration error
101	[Execution error]	1	Execution error
102	[Record error]	2	Record error
103	[Control error]	3	Control error
104	[System error A]	4	System error A
105	[System error B]	5	System error B
106	[Error in valve]	6	Error in valve
107	[Controller error]	7	Controller error
108	[Encoder error]	8	Displacement encoder error

Tab. 6.8 CPX error numbers and groups of the CMAX

6.4.4 Error and warning numbers



Information on the malfunction level and on the reset type → Sections 6.4.1 and 6.4.2. FCT supplies additional information on many diagnostic events (→ FCT). Internally, the additional information is stored in the PNU 203 (→ Description of communication profile, P.BE-CPX-CMAX-CONTROL-...).

Group 0 – Configuration errors			
CPX error group 100 (CPX-MMI: [Configuration error])			
No.	Message	Malfunction level	Reset type
01	The nominal configuration deviates from the actual configuration The nominal configuration deviates from actual configuration	F2	N
	Note	The movement test is reset to avoid tubing connection errors. The CMAX has C03 status. The movement test should then be run once more.	
	Cause	A component on the axis string does not correspond to the nominal configuration: <ul style="list-style-type: none"> – displacement encoder or sensor interface (type, length) – cylinder (type, length, diameter) – valve type 	
	Measure	<ul style="list-style-type: none"> • Check component. Replace defective or incorrect components. • Adopt actual configuration (download). 	
	Cause	The displacement encoder and valve have been exchanged and no longer match the target configuration or the serial numbers have changed.	
	Measure	<ul style="list-style-type: none"> • Check the axis configuration. Check to make sure 2 axis strings have not been interchanged. 	
02	Unknown valve Unknown valve	F2	N
	Cause	Connected valve is not supported.	
	Measure	<ul style="list-style-type: none"> • Replace valve or • Update firmware. 	
03	Unknown cylinder Unknown cylinder	F2	N
	Cause	Connected cylinder or sensor interface is not supported.	
	Measure	<ul style="list-style-type: none"> • Replace cylinder or sensor interface. • Update firmware. 	
04	Unknown displacement encoder or unknown sensor interface Unknown displacement encoder or unknown sensor interface	F2	N
	Cause	Connected displacement encoder or sensor interface is not supported.	
	Measure	<ul style="list-style-type: none"> • Replace displacement encoder or sensor interface. • Update firmware. 	

Group 0 – Configuration errors			
CPX error group 100 (CPX-MMI: [Configuration error])			
No.	Message	Malfunction level	Reset type
05	Project not loaded completely or block download active Project not loaded completely or block download active	F2	R
	Cause	Drive cannot be enabled because the target configuration is not yet complete (configuration status C00, C01 or C02).	
	Measure	<ul style="list-style-type: none"> Complete the target configuration, e.g. download project again. 	
	Cause	Drive cannot be enabled because the block download is still active.	
	Measure	<ul style="list-style-type: none"> End block download. Check and correct the control program (parameterisation). 	
08	Cylinder, valve or sensor interface was replaced Cylinder, valve or sensor interface was replaced	W	F
	Note	The movement test is reset to avoid tubing connection errors. The CMAX has C03 status. The movement test should then be run once more.	
	Cause	The serial number of a component on the axis string has changed: <ul style="list-style-type: none"> drive (displacement encoder) valve 	
	Measure	<ol style="list-style-type: none"> Accept the serial number of the component. Run movement test (recommendation). Perform identification (recommendation). 	
09	Project contains incorrect parameters Project contains incorrect parameters	F2	N
	Cause	Drive configuration is not supported by the firmware used.	
	Measure	<ul style="list-style-type: none"> Update firmware. 	
	Cause	Invalid values concerning axis parameters or hardware configuration (e.g. software end positions).	
	Measure	<ul style="list-style-type: none"> Determine, check and correct the affected parameters with additional information (diagnostics: Active messages or diagnostic memory) 	

Group 1 – Execution error			
CPX error group 101 (CPX-MMI: [Execution error])			
No.	Message	Malfunction level	Reset type
10	Homing not executed Homing not executed	F1	R
	Cause	Drive with incremental displacement encoder is not referenced.	
	Measure	<ul style="list-style-type: none"> Perform homing. 	
11	Homing not required Homing not required	F1	R
	Cause	Homing with absolute displacement encoder.	
	Measure	<ul style="list-style-type: none"> Do not perform homing. 	

Group 1 – Execution error				
CPX error group 101 (CPX-MMI: [Execution error])				
No.	Message	Malfunction level	Reset type	
13	Wrong direction of movement during movement test Wrong direction of movement during movement test	F2	R	
	Cause Measure			Incorrect tubing connection to cylinder and valve. <ul style="list-style-type: none"> • Check and correct the tubing connection.
14	Movement test not carried out Movement test not carried out	F2	R	
	Cause Measure			Positioning command without valid movement test. <ul style="list-style-type: none"> • Perform movement test (recommended) or skip.
15	Result of the movement test not clear Result of the movement test not clear	F1	R	
	Cause Measure			Drive jammed. <ul style="list-style-type: none"> • Check friction of the drive and guide. • Check pressure build-up with trace.
	Cause Measure			Obstacle in the travel path <ul style="list-style-type: none"> • Check travel path and software end positions.
	Cause Measure			Working pressure insufficient to move the load. <ul style="list-style-type: none"> • Set sufficient working pressure and check the load.
	Cause Measure			Cylinder not correctly projected. <ul style="list-style-type: none"> • Check size and correct.
	Cause Measure			Valve defective. <ul style="list-style-type: none"> • Check pressure build-up with trace. Replace valve if defective.
	Cause Measure			Faulty tubing connection. <ul style="list-style-type: none"> • Check tubing connection.
	Cause Measure			Valves (additional pneumatic circuit) installed between the valve and cylinder are closed. <ul style="list-style-type: none"> • Open valves.
	16			Identification failed Identification failed
Cause Measure		Incorrect base load and/or payload parameterised or incorrect payload transferred to parameter 2 (byte 5 ... 8 in commissioning mode). <ul style="list-style-type: none"> • Check load and data. 		
Cause Measure		Too much mechanical play in the system. <ul style="list-style-type: none"> • Check system structure. 		
Cause Measure		Constructional design not stable enough. <ul style="list-style-type: none"> • Check system structure. 		
Cause Measure		Tubes used are too long. <ul style="list-style-type: none"> • Move valve closer to the drive. 		
Cause Measure		Compressed air not sufficiently stable. <ul style="list-style-type: none"> • Check compressed air supply. 		

Group 1 – Execution error				
CPX error group 101 (CPX-MMI: [Execution error])				
No.	Message	Malfun- ction level	Reset type	
17	Identification not yet executed Identification not yet executed	W	F	
	Cause Measure			Identification was not executed before record start and direct mode. <ul style="list-style-type: none"> Carry out identification.
18	Clamping unit was activated with operation enable Clamping unit was activated with operation enable	W	F	
	Cause Measure			Operation enable was granted (CCON.STOP = 1), although the clamping unit was not yet released, or the clamping unit was closed without the operation enable having been blocked beforehand (CCON.STOP=0). <ul style="list-style-type: none"> Remove operation enable. Release clamping unit. Correct the sequence when changing from operation enable and clamping unit.
19	Impermissible change of operating mode Impermissible change of operation mode	F1	R	
	Cause Measure			Change between record select mode and direct mode with active positioning command (SPOS.MC=0). <ul style="list-style-type: none"> Only perform the shift after positioning command is completed (SPOS.MC = 1).
	Cause Measure			Change between record select mode or direct mode and commissioning or parameterisation during active operation enable (CCON.STOP = 1). <ul style="list-style-type: none"> Only perform the shift without operation enable. Set CCON.STOP = 0 and wait for SCON.READY = 0 and SPOS.MC = 1.

Group 2 – Position set errors			
CPX error group 102 (CPX-MMI: [Execution error])			
No.	Message	Malfun- ction level	Reset type
21	Invalid record number Invalid record number	F1	R
	Cause Measure		
22	Record is not configured Record is not configured	F1	R
	Cause Measure		

Group 2 – Position set errors				
CPX error group 102 (CPX-MMI: [Execution error])				
No.	Message	Malfunction level	Reset type	
23	Record is locked Record is locked	F1	R	
	Cause Measure			The retrieved record is not approved for execution (→ PNU 403). <ul style="list-style-type: none"> • Check and enable record.
24	Step enabling condition is not permissible Step enabling condition is not permissible	F1	R	
	Cause Measure			The demanded step enabling condition is invalid. <ul style="list-style-type: none"> • Check and correct the step enabling condition.
	Cause Measure			Continuation parameterised in record 64. <ul style="list-style-type: none"> • Remove step enabling condition in record 64.
	Cause Measure			The selected step enabling condition is not permissible when using a DSMI. DSMI does not support force control. <ul style="list-style-type: none"> • Correct step enabling condition.
	Cause Measure			The selected step enabling condition is only permissible in a record with force control. <ul style="list-style-type: none"> • Check and correct record.
27	Step enabling condition cannot be reached during positioning task Step enabling condition cannot be reached during positioning task	F1 (W)	R	
	Note			Message can be parameterised alternatively as a warning (W) or error (F1).
	Cause Measure			Step enabling position does not lie between the start position (last setpoint or actual value at the time of the step enabling) and the new setpoint position, or both positions are the same. <ul style="list-style-type: none"> • Check and correct the step enabling condition. Check the program sequence in the controller. After a stop or error, the previous position must be approached again.
	Cause Measure			The step enabling force is not between the starting force (last setpoint or actual value at the time of switching) and the new force setpoint, or both forces are the same. <ul style="list-style-type: none"> • Check and correct the step enabling condition. Check the program sequence in the controller. After a stop or error, the previous position must be approached again or the previous force command repeated.
28	Step enabling condition was not reached Step enabling condition was not reached	F1 (W)	R	
	Note			Message can be parameterised alternatively as a warning (W) or error (F1).
	Cause Measure			Step enabling was not executed. MC was reached before the step enabling condition was fulfilled. <ul style="list-style-type: none"> • Check step enabling condition. • Check the program sequence in the controller.

Group 3 – Control error			
CPX error group 103 (CPX-MMI: [Control error])			
No.	Message	Malfunction level	Reset type
30	Time-out: Target value not reached Timeout: Target value not reached	F1	R
	Note	The drive did not reach the target tolerance on time (MC monitoring). Record chaining is cancelled. Can, for instance, occur during positioning or jogging on a stop within the effective stroke.	
	Cause Measure	Obstacle in the travel range (only position controller). <ul style="list-style-type: none"> Remove obstacle or correct target position. 	
	Cause Measure	Compressed air not sufficient. <ul style="list-style-type: none"> Check supply pressure, check tubing connection, configure message 50 as an error; enable drive with closed clamping unit only when there is sufficient supply pressure. 	
	Cause Measure	Very strong friction or irregular friction (only position controller). <ul style="list-style-type: none"> Increase control amplification. 	
	Cause Measure	Mechanical play (only position controller) <ul style="list-style-type: none"> Check installation: Load, stability, guides, check play, repeat identification. 	
	Cause Measure	System not optimally configured. <ul style="list-style-type: none"> Check configuration (valve, payload, base load, mounting position, supply pressure), increase time-out, increase tolerance. 	
	Cause Measure	Modified system behaviour (only position controller). <ul style="list-style-type: none"> Repeat identification. 	
31	No movement after start No movement after start	F1	R
	Note	Time-out: The drive has moved less than 11 mm within the time-out period.	
	Cause Measure	Pressure could not be built up. <ul style="list-style-type: none"> Check supply pressure. 	
	Cause Measure	Drive jammed or sluggish. <ul style="list-style-type: none"> Check guide and mechanical structure. 	
	Cause Measure	Working pressure insufficient to move the entire load. <ul style="list-style-type: none"> Set sufficient working pressure and check configuration of the load. 	
	Cause Measure	Valve defective. <ul style="list-style-type: none"> Check pressure build-up with trace; replace valve if defective. 	
	Cause Measure	Faulty tubing connection. <ul style="list-style-type: none"> Check tubing connection. 	
	Cause Measure	Valves (additional pneumatic circuit) installed between the valve and cylinder are closed. <ul style="list-style-type: none"> Open valves. 	

Group 3 – Control error			
CPX error group 103 (CPX-MMI: [Control error])			
No.	Message	Malfunction level	Reset type
32	Target force outside the force limits Target force outside the force limits	F1 (W)	R
	Note	Message can be parameterised alternatively as a warning (W) or error (F1).	
	Cause	Target force outside the set force limits.	
	Measure	<ul style="list-style-type: none"> Correct target force or force limit. 	
	Cause	The target force is larger than the maximum force that can be reached (the maximum attainable target force determined by the CMAX may deviate from the theoretical value calculated by the FCT).	
	Measure	<ul style="list-style-type: none"> Correct target force, increase supply pressure, reduce moving load in vertical structure, use larger drive. 	
33	Target position outside the software or hardware end positions Target position outside the software or hardware end positions	F1 (W)	R
	Note	Message can be parameterised alternatively as an error (F1) or warning (W).	
	Cause	Target position is outside the set software end positions.	
	Measure	<ul style="list-style-type: none"> Check and correct target position, software end positions and project zero point. 	
	Cause	Target position is outside the reachable hardware end positions.	
	Measure	<ul style="list-style-type: none"> Check and correct target position and project zero point. 	
34	Setpoint value in tracking mode outside the limit values Setpoint value in tracking mode outside the limit values	W (F1)	F (R)
	Note	Message can be parameterised alternatively as a warning (W) or error (F1).	
	Cause	Setpoint position is outside the set software end positions.	
	Measure	<ul style="list-style-type: none"> Check and correct setpoint position, software end positions and project zero point. 	
	Cause	Setpoint position is outside the reachable hardware end positions.	
	Measure	<ul style="list-style-type: none"> Check and correct setpoint position and project zero point. 	
35	Software end position passed Software end position passed	W (F1)	F (R)
	Note	The actual position has exceeded a software end position with active position control, whereby a tolerance of 2 mm has been taken into account. Message can be parameterised alternatively as a warning (W) or error (F1).	
	Cause	The drive was pushed out of the valid range by an external force.	
	Measure	<ul style="list-style-type: none"> Prevent external force, if possible. 	
	Cause	Controllers which are not optimally set can lead to considerable overshooting.	
	Measure	<ul style="list-style-type: none"> Optimize controller, check parameterisation, perform identification again. 	

Group 3 – Control error			
CPX error group 103 (CPX-MMI: [Control error])			
No.	Message	Malfunc- tion level	Reset type
36	Software end position reached during force control Software end position reached during force control	F1	R
	Note	The actual position has exceeded a software end position with active force control. A tolerance of 2 mm has been taken into account here.	
	Cause	No workpiece.	
	Measure	<ul style="list-style-type: none"> • Check workpiece; check workpiece position. • Use record sequencing for return travel or stop. 	
37	Switch to Free Profile Switch to Free Profile	W	R
	Cause	<p>An attempt was made to sequence from an active positioning command to a positioning command with Auto Profile.</p> <p>In record select mode: Record sequencing with switching condition not identical to “after MC” (12) or start of a new record before CPOS.MC=1</p> <p>In direct mode: Start of a new positioning command before CPOS.MC=1</p> <p>The positioning command was not executed as configured in the Auto Profile, but in the Unassigned Profile. For speed, acceleration and deceleration, the default values (PNU 600, 602, 603) are used.</p>	
	Measure	<ul style="list-style-type: none"> • Change subsequent command to Unassigned Profile, parameterise accelerations and speed. 	
	Cause	<p>A positioning command is started with Auto Profile, although no dynamic identification has been performed yet.</p> <p>The positioning command was not executed as configured in the Auto Profile, but in the Unassigned Profile. For speed, acceleration and deceleration, the default values (PNU 600, 602, 603) are used.</p>	
38	Critical stroke XLIM reached with force control Critical stroke XLIM reached with force control	F1	R
	Cause	Parameterised stroke limit is exceeded with force control.	
	Measure	<ul style="list-style-type: none"> • Check workpiece; check critical stroke parameters or deactivate stroke monitoring. 	

Group 3 – Control error			
CPX error group 103 (CPX-MMI: [Control error])			
No.	Message	Malfunction level	Reset type
39	Critical speed VLIM reached with force control Critical velocity VLIM reached with force control	F1	R
	Cause Measure	Critical speed has been exceeded with force control. <ul style="list-style-type: none"> Check workpiece, check critical speed parameters or deactivate speed monitoring. 	
	Cause Measure	The reduced speed parameter of the force record is too large compared to the parameter for critical speed. <ul style="list-style-type: none"> The parameters for reduced speed and critical speed are co-ordinated. 	
	Cause Measure	In the event of record sequencing to force control, the actual speed of the drive is too high at the time of the shift. <ul style="list-style-type: none"> Reduce the speed of the previous record, correct the critical speed, deactivate speed monitoring. 	

Group 4 – System error A			
CPX error group 104 (CPX-MMI: [System error A])			
No.	Message	Malfunction level	Reset type
40	Impermissible control mode with force control Impermissible control mode with force control	F1	R
	Cause Measure	Force control set for DSMI. <ul style="list-style-type: none"> DSMI cannot execute force control commands. 	
	Cause Measure	Impermissible control mode set in the RCB1 or CDIR <ul style="list-style-type: none"> Correct RCB1 or CDIR. 	
	Cause Measure	Continuous setpoint adjustment with force control not possible. <ul style="list-style-type: none"> CDIR.CONT must be set to 0. 	
41	Positioning mode “Relative” not permissible in tracking mode Positioning mode Relative not permissible in tracking mode	F1	R
	Cause Measure	Relative bit (CDIR.REL=1) set in tracking mode. <ul style="list-style-type: none"> Continuous setpoint specification may only occur absolutely. 	
42	Reserved control bits set Reserved control bits set	W	F
	Cause Measure	Reserved bit set in CCON, CPOS or CDIR. <ul style="list-style-type: none"> Check and correct CCON, CPOS and CDIR. 	

Group 4 – System error A			
CPX error group 104 (CPX-MMI: [System error A])			
No.	Message	Malfunction level	Reset type
43	Valve and displacement encoder not connected or communication faulty Valve and displacement encoder not connected or communication faulty	F2	N
	Cause Measure	Neither a valve nor a displacement encoder were found during initialization. • Check installation.	
	Cause Measure	Communication to the valve and displacement encoder is faulty. • Check cables and components.	
	Cause Measure	Communication faulty, e.g. due to impermissible or damaged components on the axis string. • Check installation, replace components.	

Group 4 – System error A			
CPX error group 104 (CPX-MMI: [System error A])			
No.	Message	Malfunc- tion level	Reset type
44	Teaching not possible Teaching not possible	F1	R
	Note	Exact cause → Diagnostic memory or additional information in PNU 203.	
	Cause	Teaching (falling edge on CPOS.TEACH) is triggered unintentionally through disconnection or switching off of the control.	
	Measure	<ul style="list-style-type: none"> Only activate CPOS.TEACH = 1 (prepare teaching) directly before the teaching process. Always end teaching immediately. 	
	Cause	Teaching not possible in direct mode.	
	Measure	<ul style="list-style-type: none"> Change operating mode. 	
	Cause	Teaching not possible during active commissioning operation.	
	Measure	<ul style="list-style-type: none"> First end commissioning operation. 	
	Cause	In the commissioning mode, the teaching target in parameter 1 is invalid.	
	Measure	<ul style="list-style-type: none"> Correct parameter 1. 	
	Cause	Without reference, teaching is not possible.	
	Measure	<ul style="list-style-type: none"> Perform homing prior to teaching. 	
	Cause	Lower software end position (SWEP) is greater than/equal to the upper SWEP when teaching the SWEP in the commissioning mode. The SWEP is not adopted.	
	Measure	<ul style="list-style-type: none"> Teach upper SWEL first. Correct the teach position. 	
	Cause	Upper software end position (SWEP) is less than/equal to the lower SWEP when teaching the SWEP in the commissioning mode. The SWEP is not adopted.	
	Measure	<ul style="list-style-type: none"> Teach lower SWEP first. Correct the teach position. 	
	Cause	Specified record number impermissible when teaching in record select mode.	
	Measure	<ul style="list-style-type: none"> Correct record number. 	
	Cause	Parameterised control mode of the selected record when teaching in record select mode is not permissible.	
	Measure	<ul style="list-style-type: none"> Correct control mode; correct record number. 	
	Cause	Change of operating mode during active teaching process (CPOS.TEACH=1).	
	Measure	<ul style="list-style-type: none"> Do not change the operating mode during CPOS.TEACH=1. 	

Group 4 – System error A				
CPX error group 104 (CPX-MMI: [System error A])				
No.	Message	Malfunction level	Reset type	
45	Faulty commissioning function or parameter Faulty commissioning function or parameter	F1	R	
	Cause	Invalid function number when starting a commissioning operation in the commissioning mode (→ I/O data, commissioning mode - byte 3).		
	Measure	<ul style="list-style-type: none"> • Correct the function number. 		
	Cause	At least one parameter of the started commissioning operation had an invalid value (→ I/O data, commissioning mode - byte 4 ... 8).		
	Measure	<ul style="list-style-type: none"> • Check and correct parameter 1 and parameter 2. 		
46	Start during active teach command not permitted Start during active teach command not permitted	F1	R	
	Cause	Commissioning mode: Starting a commissioning operation during an active teaching process (SPOS.TEACH=1) is not permissible		
	Measure	<ul style="list-style-type: none"> • Do not perform a start while teaching; end teaching first. 		
	47	Start during active positioning command not permitted Start during active positioning command not permitted	F1	R
		Cause	Starting the tracking mode during an active positioning command is not permissible.	
Measure		<ul style="list-style-type: none"> • End the active positioning command and wait for Motion Complete (SPOS.MC=1). 		
Cause		Rising edge at CPOS.START not permitted during: <ul style="list-style-type: none"> – homing – jogging – commissioning operation 		
Measure		<ul style="list-style-type: none"> • Active positioning command must be completed or stopped (SPOS.MC=1). 		
47	Cause	Rising edge at CPOS.HOME not permitted during: <ul style="list-style-type: none"> – homing – jogging – commissioning operation – positioning command 		
	Measure	<ul style="list-style-type: none"> • Active positioning command must be completed or stopped (SPOS.MC=1). 		
	Cause	Rising edge at CPOS.JOBN or CPOS.JOBN during active positioning command.		
Measure	<ul style="list-style-type: none"> • Active positioning command must be completed or stopped (SPOS.MC=1). 			

Group 5 – System error B			
CPX error group 105 (CPX-MMI: [System error B])			
No.	Message	Malfunction level	Reset type
50	Supply pressure is too low Supply pressure is too low	W (F2)	F
	Note	Message can be parameterised alternatively as a warning (W) or error (F2).	
	Cause	Pressure in both cylinder chambers is too low or rises too slowly. The response delay for pressure monitoring can be optimised with FCT or PNU 1144.	
	Measure	<ul style="list-style-type: none"> • Check compressed air supply. • Adjust response delay parameter (➔ FCT or PNU 1144). 	
51	Controller load voltage outside the tolerance range Controller load voltage outside tolerance range	F2	F
	Cause Measure	Load voltage < 20 V with enabled drive or overload on axis string. <ul style="list-style-type: none"> • Check load supply for valves (U_{VAL}). 	
52	Controller operating voltage outside the tolerance range Controller operating voltage outside tolerance range	F2	F
	Cause Measure	Operating voltage < 18 V or overload on the axis string. <ul style="list-style-type: none"> • Operating voltage supply for electronics/sensors ($U_{EL/SEN}$). 	
53	Load voltage overload on the controller Load voltage overload on the controller	F2	F
	Cause	Short circuit in the cables of the axis string (between controller and valve or valve and sensor interface).	
	Measure	<ul style="list-style-type: none"> • Check cables and modules on the axis string (e.g. wire break); replace defective cables. 	
	Cause Measure	Overload on valve outputs. <ul style="list-style-type: none"> • Check and correct the circuitry for the outputs. 	
	Cause Measure	Defect in the valve. <ul style="list-style-type: none"> • Check cables and valve systematically; replace defective components. 	
	Cause Measure	Defect in CMAX. <ul style="list-style-type: none"> • Check CMAX and exchange if defective. 	

Group 5 – System error B				
CPX error group 105 (CPX-MMI: [System error B])				
No.	Message	Malfunction level	Reset type	
54	Operating voltage overload on the controller Operating voltage overload on the controller	F2	F	
	Cause			Short circuit in the cables of the axis string (between controller and valve or valve and sensor interface).
	Measure			<ul style="list-style-type: none"> Check cables and modules on the axis string (e.g. wire break); replace defective cables.
	Cause			Defect in the CMAX controller
	Measure			<ul style="list-style-type: none"> Check CMAX; replace if defective.
	Cause	Defect in the valve		
	Measure	<ul style="list-style-type: none"> Check cables and valve systematically; replace defective components. 		
	Cause	Defect in displacement encoder or sensor interface		
	Measure	<ul style="list-style-type: none"> Check cables and displacement encoder or sensor interface systematically. Replace defective components. 		
56	Supply pressure too low for homing Supply pressure too low for homing	F1	R	
	Cause			Insufficient working pressure was detected during homing.
	Measure	<ul style="list-style-type: none"> Check and correct operating pressure. Check parameterisation of the operating pressure. 		
	57	Time-out diagnostic interface: FCT device control was deactivated Timeout diagnostic interface: FCT device control was deactivated	W	R
Cause	Connection between PC and CPX node interrupted.			
	Measure	<ul style="list-style-type: none"> Check cables. 		
	Cause	Communication breakdown due to FCT		
	Measure	<ul style="list-style-type: none"> Restore connection. 		

Group 5 – System error B			
CPX error group 105 (CPX-MMI: [System error B])			
No.	Message	Malfunction level	Reset type
58	Handshake error Handshake error	F1 (W)	R
	Note	Message can be parameterised alternatively as a warning (W) or error (F1).	
	Cause	CPOS.START set with operation enable. Note: If E58 is configured as warning W58, SPOS.ACK = 1 is set with operation enable.	
	Measure	<ul style="list-style-type: none"> Reset CPOS.START before operation enable (CPOS.START = 0). 	
	Cause	CPOS.HOME set with operation enable. Note: If E58 is configured as warning W58, SPOS.ACK = 1 is set with operation enable.	
	Measure	<ul style="list-style-type: none"> Reset CPOS.HOME before operation enable (CPOS.HOME = 0). 	
	Cause	Rising edge at CPOS.START or CPOS.HOME or CPOS.JOGP or CPOS.JOBN although SPOS.ACK = 1 (positioning command is ignored).	
	Measure	<ul style="list-style-type: none"> New positioning command only with SPOS.ACK = 0 	
	Cause	CPOS.JOGP set with operation enable.	
	Measure	<ul style="list-style-type: none"> Reset CPOS.JOGP before operation enable (CPOS.JOGP = 0). 	
	Cause	CPOS.JOBN set with operation enable.	
	Measure	<ul style="list-style-type: none"> Reset CPOS.JOBN before operation enable (CPOS.JOBN = 0). 	
	Cause	Simultaneous start of multiple positioning commands.	
	Measure	<ul style="list-style-type: none"> Only start one positioning command. 	

Group 6 – Valve error			
CPX error group 106 (CPX-MMI: [Error in valve])			
No.	Message	Malfunction level	Reset type
60	Valve not connected or communication faulty Valve not connected or communication faulty	F2	N
	Cause	When switching on, only the displacement encoder/sensor interface was found. The valve was not detected.	
	Measure	<ul style="list-style-type: none"> Check cables to the valve. Replace valve. 	
	Cause	Communication between CMAX and valve was interrupted.	
	Measure	<ul style="list-style-type: none"> Check cables of the axis string, valve and displacement encoder systematically; replace defective components. 	

Group 6 – Valve error				
CPX error group 106 (CPX-MMI: [Error in valve])				
No.	Message	Malfunction level	Reset type	
61	Valve hardware faulty Valve hardware faulty	F2	N	
	Cause			The valve reports a hardware error.
	Measure			<ul style="list-style-type: none"> • Replace valve.
62	Valve over-temperature Valve over-temperature	F2	F	
	Cause			The valve reports over-temperature (ambient temperature too high).
	Measure			<ul style="list-style-type: none"> • Provide sufficient cooling.
63	Valve jammed Valve jammed	F2	F	
	Cause			The valve piston does not move as expected.
	Measure			<ul style="list-style-type: none"> • Replace valve. • Also check the air quality (5 µ-filter and dry air).
64	Valve load voltage outside tolerance range Valve load voltage outside tolerance range	F2	F	
	Cause			The valve reports insufficient load voltage. Either the cable between the CMAX and the valve is faulty, or the valve is defective.
	Measure			<ul style="list-style-type: none"> • Check lines on the axis string. • Check valve; replace if defective.
65	Valve operating voltage outside tolerance range Valve operating voltage outside tolerance range	F2	F	
	Cause			The valve reports insufficient operating voltage. Either the cable between the CMAX and the valve is faulty, or the valve is defective.
	Measure			<ul style="list-style-type: none"> • Check lines on the axis string. • Check valve; replace if defective.
66	Overload at digital output of valve Overload at digital output of valve	F2	F	
	Cause			The valve reports an overload on the digital output.
	Measure			<ul style="list-style-type: none"> • Check and correct the circuitry.
67	Overload at 24 V supply output of valve Overload at 24 V supply output of valve	F2	F	
	Cause			The valve reports an overload on the voltage output.
	Measure			<ul style="list-style-type: none"> • Check and correct the circuitry.

Group 6 – Valve error			
CPX error group 106 (CPX-MMI: [Error in valve])			
No.	Message	Malfunction level	Reset type
68	Preliminary warning valve over-temperature Preliminary warning valve over-temperature	W	F
	Cause Measure	The valve reports a high operating temperature. (Ambient temperature too high). <ul style="list-style-type: none"> • Provide sufficient cooling. 	

Group 7 – Controller error			
CPX error group 107 (CPX-MMI: [Controller error])			
No.	Message	Malfunction level	Reset type
72	System software error System software error	FS	Poff
	Cause Measure	Internal software error (firmware). <ul style="list-style-type: none"> • If possible, read diagnostic memory and save and archive the project. • Switch controller off/on and check whether error occurs again. • Contact Support. 	
73	Controller hardware faulty Controller hardware faulty	FS	Poff
	Cause Measure	No communication possible with CMAX. Error is only shown on the display. <ul style="list-style-type: none"> • Replace CMAX. 	
74	No firmware No firmware	FS	Poff
	Cause Measure	No firmware. No communication possible via fieldbus. <ul style="list-style-type: none"> • Firmware download with FCT. 	
75	User data damaged User data damaged	F2	N
	Cause Measure	Inconsistent user data. <ul style="list-style-type: none"> • Perform data reset and re-commission the axis. 	
76	Watchdog error; possible data loss; data reset required Watchdog error: possible data loss, data reset required	F2	F
	Cause Measure	Internal watchdog error <ul style="list-style-type: none"> • Check whether the CMAX is subjected to strong electromagnetic interference, and eliminate this if applicable. Perform data reset and re-commission the axis. • Contact Support. 	

Group 8 – Displacement encoder error				
CPX error group 108 (CPX-MMI: [Encoder error])				
No.	Message	Malfunction level	Reset type	
80	Displacement encoder not connected or communication faulty Displacement encoder not connected or communication faulty	F2	N	
	Cause Measure			Displacement encoder/sensor interface was not detected when switching on. <ul style="list-style-type: none"> Replace position measuring system/sensor interface; check the cables.
	Cause Measure			Communication between CMAX and displacement encoder/sensor interface is faulty. <ul style="list-style-type: none"> Check cables of the axis string, valve and displacement encoder/sensor interface systematically; replace if defective.
81	Hardware of the displacement encoder or sensor interface faulty Hardware of the displacement encoder or sensor interface faulty	F2	N	
	Cause Measure			Hardware of the displacement encoder or sensor interface defective. <ul style="list-style-type: none"> Replace displacement encoder/sensor interface.
	Cause Measure			Fault during initialization of the displacement encoder/sensor interface. <ul style="list-style-type: none"> Replace displacement encoder/sensor interface. Check compatibility of the displacement encoder/sensor interface with the firmware version of the CMAX.
82	Invalid measured values or displacement encoder faulty Invalid measured values or displacement encoder faulty	F2	F	
	Cause Measure			DGCI/DDLI: No magnet present. <ul style="list-style-type: none"> Check magnet on the displacement encoder, replace magnet holder if defective.
	Cause Measure			DGCI/DDLI: Several magnets present. <ul style="list-style-type: none"> Make sure that no external magnets are in close proximity to the displacement encoder.
	Cause Measure			DGCI/DDLI: Multiple pulses (e.g. due to vibrations). <ul style="list-style-type: none"> Check mounting. Avoid vibration.
	Cause Measure			DNCI: Sensor error. <ul style="list-style-type: none"> Replace sensor head in the DNCI.
	Cause Measure			Potentiometer: Operating voltage drop below 12 V. <ul style="list-style-type: none"> Check operating voltage, check cables for short circuit and corrosion.
84	Reference position of the displacement encoder lost Reference position of the displacement encoder lost	F2	N	
	Cause Measure			Although the drive has set the status “Referenced”, the displacement encoder/sensor interface reports the status “Not referenced”. <ul style="list-style-type: none"> Reference again.

Group 8 – Displacement encoder error				
CPX error group 108 (CPX-MMI: [Encoder error])				
No.	Message	Malfunction level	Reset type	
85	Operating voltage of displacement encoder/sensor interface outside the tolerance range Operating voltage of displacement encoder/sensor interface outside tolerance	F2	F	
	Cause Measure			Operating voltage of the displacement encoder too low. <ul style="list-style-type: none"> • Check power supply. • Check lines on the axis string.
87	Defective displacement encoder cable or potentiometer in electrical end position Defective displacement encoder cable or potentiometer in electrical end position	F2	N	
	Cause Measure			Defective displacement encoder cable. <ul style="list-style-type: none"> • Check power supply. • Check lines on the axis string. • Switching off/on may be required. • If this occurs repeatedly, replace the displacement encoder or sensor interface.
	Cause Measure			Displacement encoder in the electrical end position (potentiometer only). <ul style="list-style-type: none"> • Move displacement encoder (potentiometer) from the end position.
89	Incorrect data content in the displacement encoder/sensor interface Incorrect data content in the displacement encoder/sensor interface	F2	N	
	Cause Measure			The displacement encoder/sensor interface contains incorrect or contradictory data. <ul style="list-style-type: none"> • Switch the power supply off and then on again. If the error is signaled again: <ul style="list-style-type: none"> • Replace displacement encoder/sensor interface. • Check compatibility of the displacement encoder/sensor interface with the firmware version of the CMAX.

6.5 Diagnostic functions with the CPX-MMI



Parameterisation and commissioning via FMT or CPX-MMI is not supported. Representation of the CMAX corresponds thereby to that of an I/O module. The subsequently described basic information is available.

General information on operating and commissioning the CPX terminal with the operator unit CPX-MMI-1 → Description for the operator unit, P.BE.CPX-MMI-1-....

6.5.1 Error display (menu [Diagnostics])

Modules which report an error are marked in the main menu by an exclamation mark (!) in front of the module number. In the menu [Diagnostics], errors present are displayed as input channel errors.

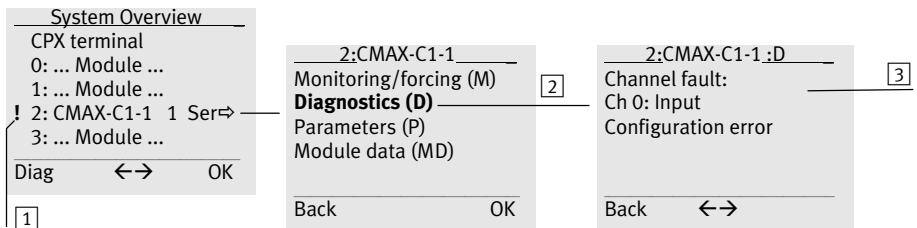

1 Error present

2 Menu [Diagnostics]

3 Error number and description

Fig. 6.3 Error display with the CPX-MMI



Errors of the CMAX cannot be acknowledged with the CPX-MMI.

6.5.2 Information on the CMAX (menu [Module Data])

The module data of the CMAX are displayed in the menu [Modul data].

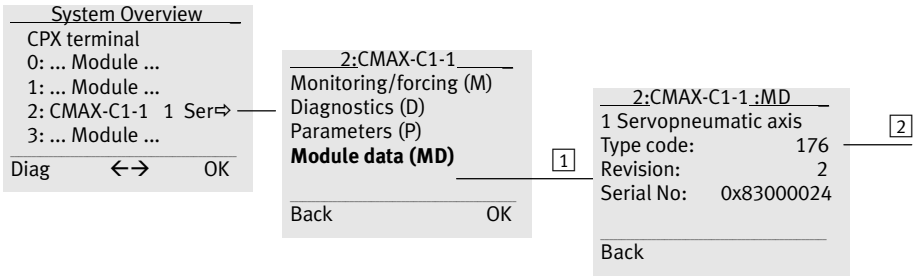

1 Menu [Module data]

2 Information

Fig. 6.4 Displaying information with the CPX-MMI

Module data	Description
Type code	Module code (CPX-specific, for the CMAX: 176)
Revision	Firmware design (e.g. 2 for version 2.00)
Serial No	Serial number of the CMAX

A Technical appendix

A.1 Technical data CMAX

General technical data	
General technical data of the CPX terminal	➔ CPX system description P.BE-CPX-SYS-...
Product weight (with CPX-GE-EV-S) [g]	Approx. 240
Protection class (completely mounted, plug connector inserted or provided with protective cap)	IP65
Protection against electric shock (Protection against direct and indirect contact in accordance with EN 60204-1)	by means of PELV power circuit (Protected Extra-Low Voltage)
Module code (CPX-specific)	176
Module identification handheld (language: English)	CMAX-C1-1

Tab. A.1 General technical data

Power supply CMAX	
Operating voltage/load voltage The following special features apply: – Load voltage range, valves (U_{VAL}) [V DC]	➔ CPX description 20 ... 30
Current consumption at nominal operating voltage – From operating voltage supply for electronics/sensors ($U_{EL/SEN}$) [mA] – From load voltage supply for valves (U_{VAL}) ¹⁾ [A]	200 Max. 400 (including the components on the axis string) Typ. 1 ... 2; max. 2.5
Galvanic isolation – Between operating voltage supply, electronics/sensors ($U_{EL/SEN}$) and load voltage supply, valves (U_{VAL})	None
Mains buffering time [ms]	10 (for systems with the DGCI, a power dropout > 1 ms causes error E85)

1) ➔ Section 4.4.1

Tab. A.2 Technical data, voltage supply

Positioning system with CMAX	
Axis string	
No. of axis strings	1
Axes per string	1
Max. total length (all cables) [m]	30
Electrical connection, control interface	<ul style="list-style-type: none"> – 5-pin – M9 – Socket
Control interface	
Data	CAN Bus with Festo protocol (Integrated terminating resistor)
Operating modes	
	<ul style="list-style-type: none"> – Record mode – Direct mode – Commissioning – Parameterisation
Record selection	
– Number of records	64
– Record modes	<ul style="list-style-type: none"> – Single position set – Configurable record sequencing
Direct mode	
– Modes	<ul style="list-style-type: none"> – Point to point – Continuous following (not for force control)
Regulating function	
	<ul style="list-style-type: none"> – Position control – Force control
Performance data	
Repetition accuracy of position control	→ Tab. A.4
Repetition accuracy of force control [%]	2 (of the maximum force)
Display	
	7-segments display
Status display (LED)	
	<ul style="list-style-type: none"> ⌚ = Module status (error) PL = Power load Dx = Display/error axis X X = MC axis X
Diagnostics	
	<ul style="list-style-type: none"> – Module-oriented diagnostics¹⁾ – Via local 7-segments display – With FCT plug-in CMAX – Through the higher-order controller
Commissioning	
	<ul style="list-style-type: none"> – With FCT plug-in CMAX – Through the higher-order controller

1) Undervoltage monitoring, valve and sensor monitoring, storage of the last 100 diagnostic messages, operating hour counter

Tab. A.3 Technical data of positioning system

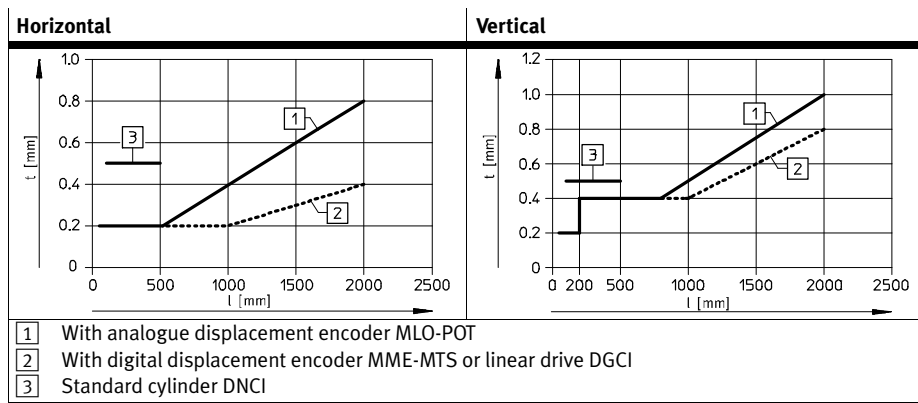

Tab. A.4 Repetition accuracy, linear drives

A.2 Replacement of components

- When replacing components, observe the notes in Tab. A.5.

Replacement	Description
<p>... of a CMAX or the CPX terminal</p>	<p>Parameterisation/identification/adaptation</p> <ul style="list-style-type: none"> – Many determined data depend on the individual components and can therefore not be parameterised manually. • After replacement, always perform the entire commissioning again. <p>Movement test</p> <ul style="list-style-type: none"> – Performance of the movement test can be skipped if the drive, displacement encoder or VPWP is unchanged and no changes were made to the tubing connection. • Recommendation: Run movement test again.
<p>... of the drive, displacement encoder or VPWP as well as changes to the tubing connection</p>	<p>Parameterisation</p> <ul style="list-style-type: none"> – When identical components are replaced, the parameterisation remains unchanged. – The serial numbers of the new components must be taken over with FCT or written with the controller, otherwise the CMAX remains in the status C03. <p>Movement test</p> <ul style="list-style-type: none"> • Urgent recommendation: Run movement test again. <p>Identification/adaptation</p> <ul style="list-style-type: none"> – The determined data depend on the individual components. • Therefore, after replacement, always perform the identification or the entire commissioning again. <p>Zero points, position values, software end positions, record table</p> <ul style="list-style-type: none"> – The reference system can change when the drive or displacement encoder is replaced! • Check reference points.

Tab. A.5 Replacement of components

A.3 Additional pneumatic circuits

You may require an additional pneumatic circuit in order to attain a particular status for the system in certain applications.

Further information

The “Guide To Safety Technology” brochure contains detailed information on:

- directives and standards
 - definition and concept of risk
 - risk assessment
 - directive-compliant procedure for safe design
 - control architectures
 - operating modes and safety functions
- sample circuit diagrams
- Festo products
- services



The brochure “Guide to Safety Technology” (“Guide To Safety Technology”) is available in the Festo support portal (➔ www.festo.com/sp).

The sub-base VABP also offers prepared solutions for generating various defined statuses of the drive, which are generated when the load voltage or supply pressure is switched off (➔ www.festo.com/sp).

B Glossary

The following product-specific terms and abbreviations are used in this description:

Term/abbreviation	Description
0xA0 (A0 _h)	Hexadecimal numbers are indicated by a prefixed "0x" or by a subscript "h".
Absolute displacement encoder	Displacement encoder with a fixed (absolute) assignment of measured value (position, angle, etc.) and measured variable, for "digital" or "potentiometer" CMAX.
Adaptation	CMAX function for automatically improving non-optimal control behaviour during operation.
Axis string	Totality of all components and cables which are connected to the CMAX via the axis interface.
Bus node	Provide the connection to specific fieldbuses. Transmit control signals to the connected modules and monitor their functioning (as a CPX module: CPX bus node).
Control interface	Connection for all modules and cables of the axis string
CPX modules	Collective term for the various modules which can be integrated into a CPX terminal.
CPX node	Collective term for all CPX bus nodes and control blocks
CPX terminal	Complete system consisting of CPX modules with or without pneumatics.
Drive	In this description, the term "drive" represents the terms linear drive (DDL, DGCI), standard cylinder (DDPC, DNC, DNCI) or semi-rotary drive (DSMI).
Festo Configuration Tool (FCT)	Software with uniform project and data management for supported types of equipment. The special requirements of a device type are supported with the necessary descriptions and dialogues by means of plug-ins.
Festo Handling and Positioning Profile (FHPP)	Communication profile for position controllers from Festo
Festo Maintenance Tool (FMT)	Diagnostics, configuration and service software for CPX terminals
Festo Parameter Channel (FPC)	FHPP-specific parameter access.
Functions	Special functions in the different operation modes, such as: <ul style="list-style-type: none"> – Jog mode – Homing run
Homing	Homing defines the homing position and thereby the origin of the measuring reference system of the axis.
I	Digital input. From the point of view of the higher-order controller, the CMAX status outputs are module input data (➔ Communication profile description, P.BE-CPX-CMAX-CONTROL-...).

Term/abbreviation	Description
Identification	System function where specific characteristics of the connected axis can be determined, e.g. the break-away forces, frictional behaviour, dynamics (maximum accelerations and speeds), etc., by means of an identification run.
Incremental displacement encoder	A path measuring system in which the measurement variable refers to a reference point and is determined by counting equally large measurement steps (increments).
I/Os	Digital inputs and outputs
Jog mode	Manual travel in a positive or negative direction. Function for setting positions by approaching the target position, e.g. for teaching records.
Logic 0	Input or output provides 0 V (also LOW, FALSE or logic 0).
Logic 1	Input or output provides 24 V (also HIGH, TRUE or logic 1).
O	Digital output. From the point of view of the higher-order controller, the CMAX control inputs are module output data (➔ Communication profile description, P.BE-CPX-CMAX-CONTROL-...).
OB	Output byte
Operating mode	Type of CMAX control, function or setpoint specification.
Parameter	Different settings which are defined for the system operation and have to be saved in the CMAX.
Parameter number (PNU)	Each parameter has a number and subindex. Notation: PNU xxxx:zz (xxxx:parameter number, zz: subindex).
PLC/IPC	Programmable logic controller/industrial PC (short: controller)
Position control	Control mode where a defined position is approached under electronic control and is kept.
Pressure/force control	Control mode for which a defined force is built up via pressure control. The term “force control” is used in this documentation.
Project zero point (PZ)	Measuring reference point for all positions in positioning jobs (Project Zero point). The project zero point forms the basis for all absolute position specifications (e.g. in the record table or in direct mode). The basis point for the project zero point is the axis zero point.
Record	Positioning command defined in the record table with parameters (e.g. target value, positioning mode, speed).
Reference point (REF)	Point of reference for the incremental displacement encoder. The reference point defines a known position within the travel of the drive.
Software end position	Programmable stroke limit (point of reference = axis zero point). Upper software end position: Max. limit position in the positive direction (increasing actual values). Lower software end position: Minimum limit position in the negative direction (decreasing actual values).

Tab. B.1 Terms and abbreviations

Index

A		F	
Abbreviations	96	Faults	67
Absolute displacement encoder	96	– CPX error messages	69
Adaptation	96	Festo Configuration Tool (FCT)	49, 96
Air pressure reservoir	34	Festo Parameter Channel (FPC)	96
Axis string	96	FHPP	49
B		Filter regulator	34
Base load	25	Fixed stops	23
C		Force control	97
CMAX		Functions	96
– Commissioning options	49	G	
– Connection and display components	16	Groups (faults and warnings)	69
– Mode of operation	16	H	
– Parameterisation options	49	Homing	96
– Tasks of the CMAX	16	Homing run after POWER ON	56
Communication profile FHPP	49	I	
Control interface	96	Identification	97
Coupling play	22	Incremental displacement encoder	97
CPX error numbers	69	Installation instructions	
CPX modules	96	– Air pressure reservoir	34
CPX node	96	– Compressed air supply	33
CPX terminal	96	– Compressed air tubing and fittings	38
Current consumption	44	– Conversion of systems	37
D		– Drive with compressed air supply	
Diagnostics		on one side	37
– CPX-MMI	89	– External potentiometer	24
– Messages	70	– Filter regulator	34
Diagnostics options	57	– Proportional directional control valve	34
Displacement encoder	21, 23	Intended use	11
– Absolute	96	IPC	97
– Incremental	97	J	
Drive	23, 96	log mode	97
E		L	
Errors	70	LEDs	58
F		Load	25
G		Logic 0	97
H		Logic 1	97
I		M	

M

Malfunction step (faults and warnings) 67
 Mass moment of inertia 26
 Mounting
 – Drive 23
 – Fixed stops 23
 Mounting position 25, 27
 Mounting position (of the axis) 26

N

Notes on the documentation 6

O

Operating mode 97

P

Parameter 97
 Payload 25
 PLC/IPC 97
 PNU 97
 Position control 97
 Positioning system 15
 – Commissioning options 49
 – Parameterisation options 49
 – Structure 15
 Power supply 44
 Power supply concept 45
 Pressure control 97
 Project zero point 97

R

Record 97
 Reference point (REF) 97
 Reset type 68

S

Safety instructions (general) 10
 Service 7
 Software end position 97
 – Negative (lower) 97
 – Positive (upper) 97
 Software status, CPX node 13
 Software version, CMAX 7
 Start-up characteristics performance 52
 Status display 63
 Status information 63, 66
 Switching off the load supply 47

T

Target group 7
 Technical data 91
 Total load 25
 – Maximum total load 26
 – Minimum total load 25, 26
 Transport and storage conditions 12
 Tubing 38
 Type code 8

V

Voltage zones 45

W

Warnings 67, 70

Reproduction, distribution or sale of this document or communication of its contents to others without express authorization is prohibited. Offenders will be liable for damages. All rights reserved in the event that a patent, utility model or design patent is registered.

Copyright:
Festo AG & Co. KG
Postfach
73726 Esslingen
Germany

Phone:
+49 711 347-0

Fax:
+49 711 347-2144

e-mail:
service_international@festo.com

Internet:
www.festo.com

Original: de