

In vitro diagnostics

Automation of point-of-care devices

FESTO



Get ready for market launches faster by working together to develop ready-to-install automation solutions for lab-on-a-chip devices to analyse patient samples on site at doctors' practices. The high industrial quality standard of the individual components is of course guaranteed.

You develop in vitro diagnostic devices.
You want to get to market quicker and more efficiently.
We are your partner for individual solutions.

→ **WE ARE THE ENGINEERS
OF PRODUCTIVITY.**



Complete and ready-to-install automation of your lab-on-a-chip system from a single source

Mobile analytical devices enable tests to be done quickly and at the place of patient care (point of care) to check for bacteria, viruses or cancer cells, for example. With Festo as a partner you can greatly speed up the development of new products and automate analysis processes with complete reliability.

What is unique is that even in this early development phase you are working with the components that will also be used in your series product. Starting from a comprehensive portfolio of components and modules, we work with you to develop ready-to-install subsystems that are perfectly adapted to your specific requirements.

Joint development of mobile in vitro diagnostics for greater efficiency

Festo has many years of experience in designing ready-to-install subsystems. We integrate valves, cylinders and sensors on valve blocks in such a way that the diaphragms on the microfluidic chips are precisely activated. This ensures that the chemicals are transported from the reservoirs into the reaction chambers exactly in the right order, for reliable and reproducible processes.

Take advantage of the engineering competency of Festo as early as possible in the planning phase and concentrate fully on the development of your microfluidic chip. We transform all process steps into automated process sequences for you.

We design a suitable valve block based on your microfluidic chip layout and select the modules that best meet your specifications. You will then very quickly receive samples that model the subsequent automation process. This saves you time-intensive and costly intermediate steps and optimisation cycles associated with building your own sample setups or conducting manual tests.



The benefits for you of collaborative engineering

- Industrial reliability
- Reduced planning – buy one part
- Fast access to multiple configurations
- Design Prototypes with Production hardware
- Fewer development loops
- Faster market launch

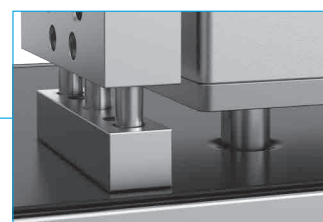

A small slide clamps the microfluidic chip, while a miniature cylinder presses one of the membranes to move reagents and perform a step in the analysis process.

Reduce effort and save time with our ready-to-install solutions

The collaborative development process culminates in a customised, ready-to-install solution for your point-of-care device. Festo can deliver this pretested subsystem to you in no time at all and in large quantities. Clear interfaces enable easy integration. A single part number for the entire unit reduces your ordering and administration effort.

Ready-to-install, pretested subsystem

- Customised design
- Compact and space-saving
- Clear interfaces for easy integration
- Documentation included
- A single part number
- Fast and reliable delivery in large quantities with consistently high quality

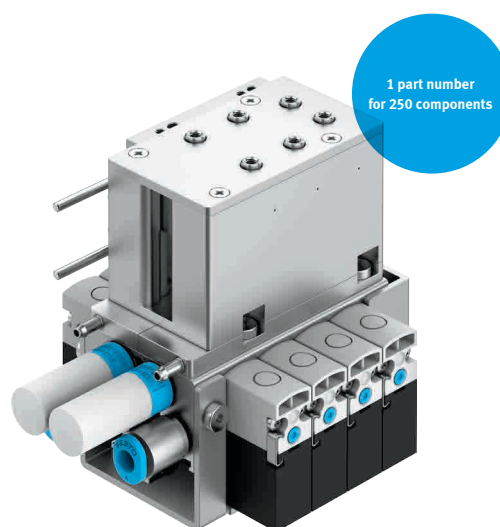

Miniaturised and integrated components and basic elements

Festo offers you a modular system made up of compact components with miniature cylinders delivering actuator technology in the smallest of spaces. Miniature valves enable a large number of tightly packed channels to be actuated while miniature sensors monitor the pressure. The valve blocks are specifically designed for the microfluidic chip layout. There are also various basic elements. These already integrate two or more components as functional units, tailored to criteria such as required space or flow rate. Using standard components makes the modules compact, cost-effective and, as a result of the industrial standard, very reliable.

With our engineering expertise, we configure the best possible solution for you.

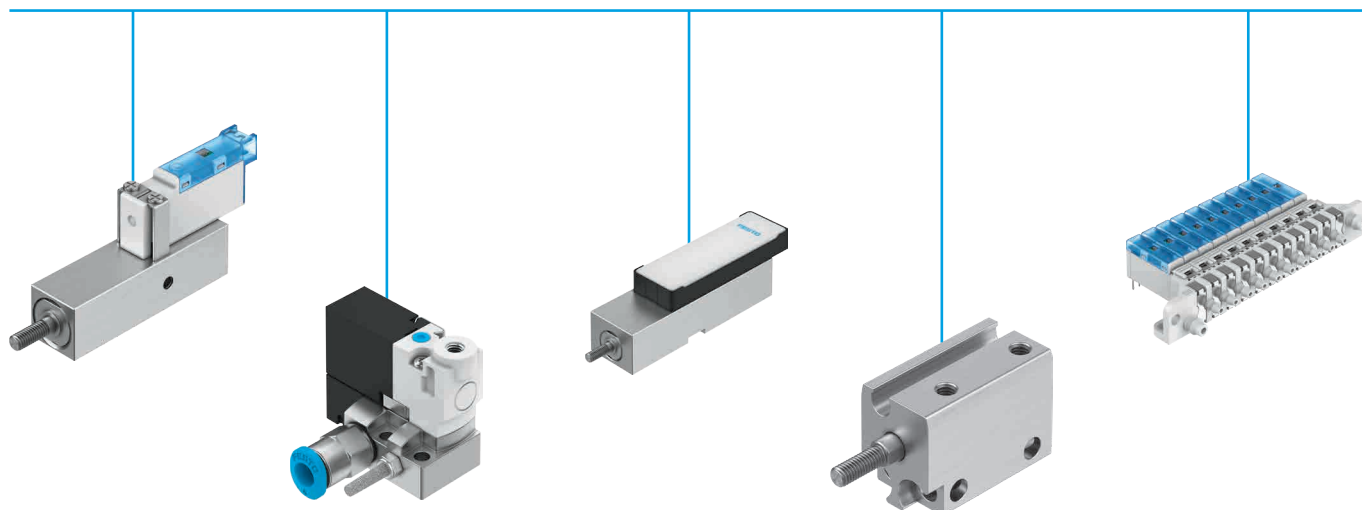

A comprehensive portfolio for your individual system

Cylinders



Round cylinder EG

- Slim design: diameter 2.5 mm
- Suitable for particularly tight layouts
- Single-acting
- Small mass: 2 to 24 g



Cartridge cylinder EGZ

- Diameter 6, 10, 16 mm
- Stroke length 5 ... 15 mm
- Force 14 ... 109 N
- Single acting, pushing

Valves

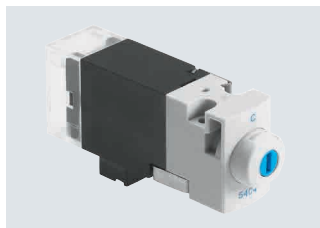

Solenoid valve MHA1

- Width 10 mm
- Short switching times

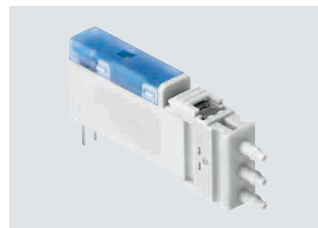

Miniature valve VOVK

- Extremely small at 6 mm wide
- Very wide pressure range: -0.9 ... 7 bar
- Very low energy consumption
- Three setup options



Piezo valve VEMC/VEMP

- Very low power consumption thanks to piezo technology
- Compact design, minimal weight
- No heat generation
- Proportional characteristics



Proportional pressure regulator VEAB

- Silent operation
- Very low energy consumption
- Short switching times
- Integrated pressure sensor with separate output

Sensors and regulators



Pressure transmitter SPTE

- Compact design
- Various pressure ranges
- Various pneumatic connection options
- Very lightweight
- Output signal: 0 ... 10 V or 1 ... 5 V



Proximity sensor SMT

- Magneto-resistive measuring principle
- Insertable in the slot from above, flush with the cylinder profile
- Short design

Pressure/vacuum generation including pressure regulation

- Integrated compressor, filtering, reservoirs and electronic pressure/vacuum regulation with proportional regulator
- Compact design
- Dynamic and precise
- Maintenance-free
- Reliable

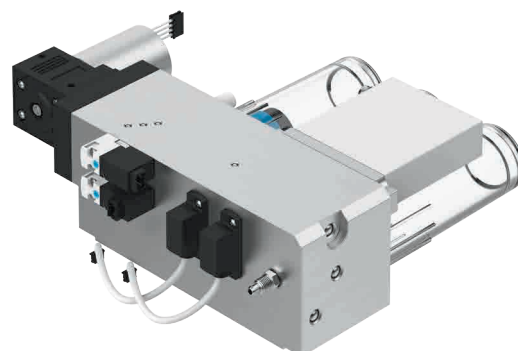

High-precision liquid handling for larger in vitro diagnostic systems in laboratories

Reliability, precision and compact dimensions are key when handling liquids. Festo offers you all this not only for mobile analytical devices but also for the automation of complex laboratory processes, from identifying and checking the sample carriers to opening and closing sample containers and dispensing liquids in microwell plates. To do this, we combine modular dosing systems with suitable handling systems to produce complete, ready-to-install functional units.

Liquid handling: diagram of pressure-controlled dispensing

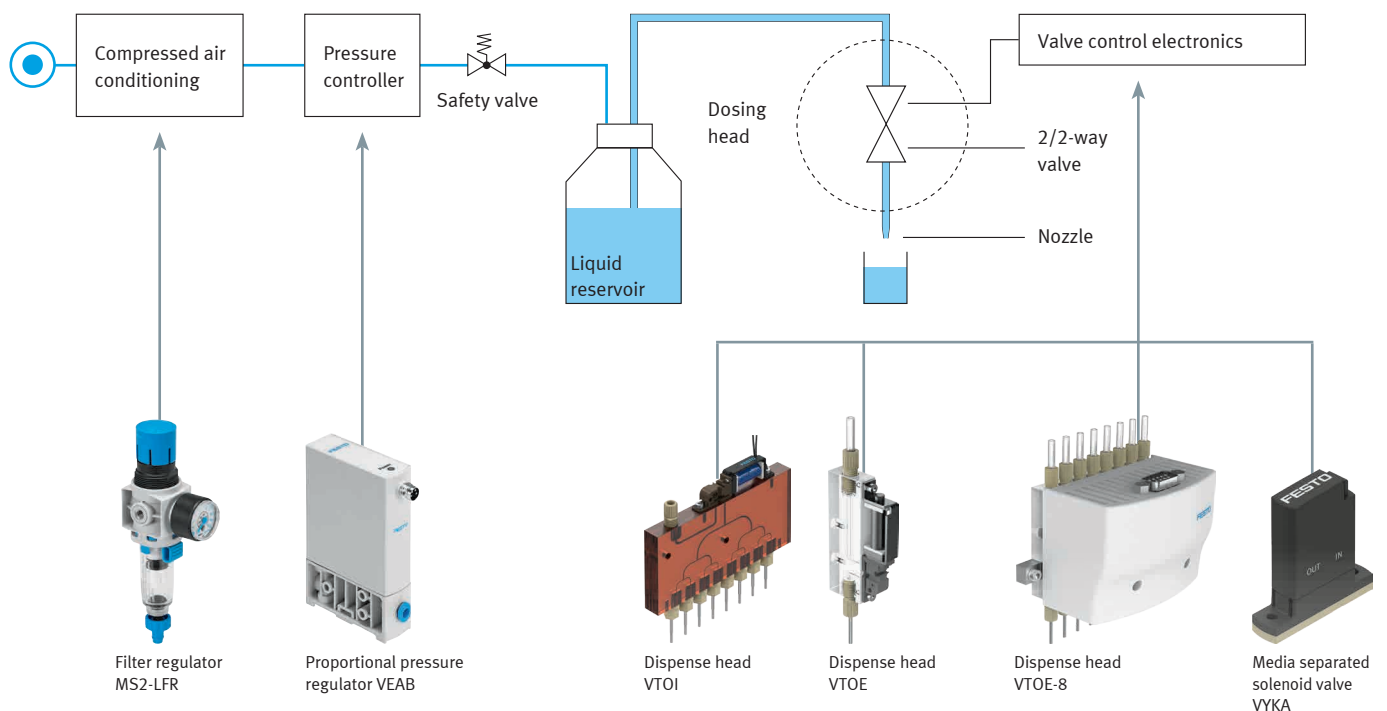

Pre-analysis: precise handling, reliable identification and testing of sample containers.



Analysis: controlled aspiration of liquids and precise dispensing in microwell plates.